

High-Precision Solutions for

MACHINING MINIATURE PARTS

1 + 1 > 2





1 + 1 > 2

*Welcome to the Powerhouse
of Precision: Tungaloy + NTK,
High-Precision Solutions for
Machining Miniature Parts!*

In the realm of machining excellence, precision reigns supreme. Tungaloy and NTK Tools form a union that transcends mere addition. It's an equation where $1+1>2$, showcasing that the whole is truly greater than the sum of its parts.

Together, we offer a comprehensive range of solutions designed to optimize performance, enhance efficiency, and elevate the quality of precision machining to unprecedented heights.

***With Tungaloy and NTK,
precision isn't just a goal—it's a guarantee.***



Tooling example for Bone Screw

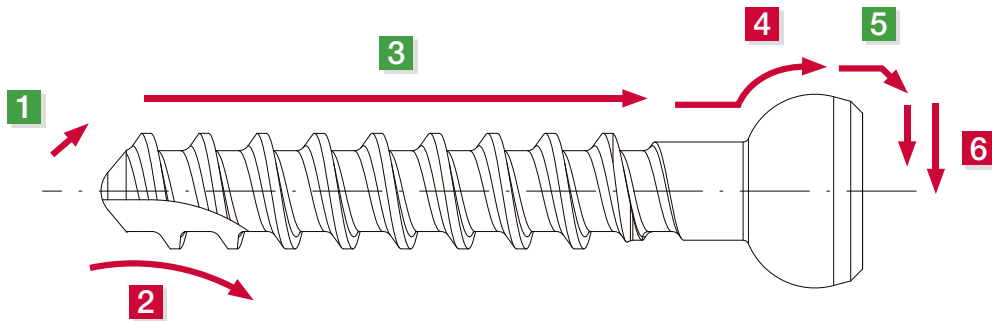

1 Front Turning

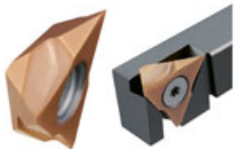

The Front Max

Holder: TFTR1214H-OH2
Insert: TFX3302MR DM4

4 Front Turning



MINI FURN MODUM TUR

Holder: QC-1212X-CHP
Head: QC12-JSDJ2XR07-CHP
Insert: DXGU070302MFL-JS SH725

2 Shoulder Milling



TUNG FORCE

Holder: VER11AL006S05-S
Holder: HPAV06M010S05R02
Insert: AVGT060300PBER-MJ AH3225

5 Back Turning



TBP Series

Holder: TBPR12H-OH2
Insert: TBP72FR10-BM TM4

3 Threading



Thread Whirling

Holder: TCW9C1040HP1
Insert: TW5835-HA5.0-D12 ZM3

6 Parting off



DUO CUT

Holder: JSXXL1212X09-CHP
Insert: JXPS12L10F SH725



Tooling example for Abutment Screw

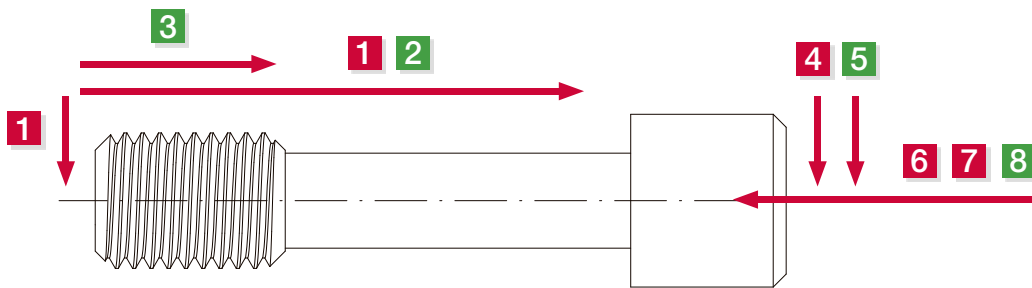

1 Front Turning



SH7025

Holder: JSVLCR0808H06
Insert: CCGT060202FN-JS SH7025

5 Back Machining



DS-ACH

Holder: DS-SDUCL16F-11-ACH
Insert: DCGT11T301MYL DT4

2 Front Turning

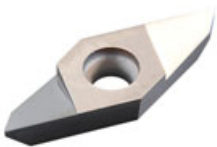

CSV Series

Holder: CSVR08NC
Insert: CSVF11FRVB VM1

6 Spot Drilling



TUNGMEISTER

Holder: VER11AL006S05-S
Insert: VCP080L07.7A45-02S05 AH725

3 Threading

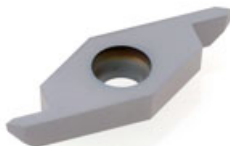

CSV Series

Holder: CSVR08NC
Insert: CSVT11FRP60-035A VM1

7 Drilling



**GIGAMINI DRILL
DSM Series**

Drill: DSM0150G05 YH170

4 Front Turning



DUO FORCE CUT

Holder: JSXXR0808H05
Insert: JVPN07R06F005-20 SH725

8 Socket Machining



Shaper Duo

Sleeve: HY-NBH02016G-OH
Insert bar: SSP020N1130H TM4



Tooling example for Printer Shaft

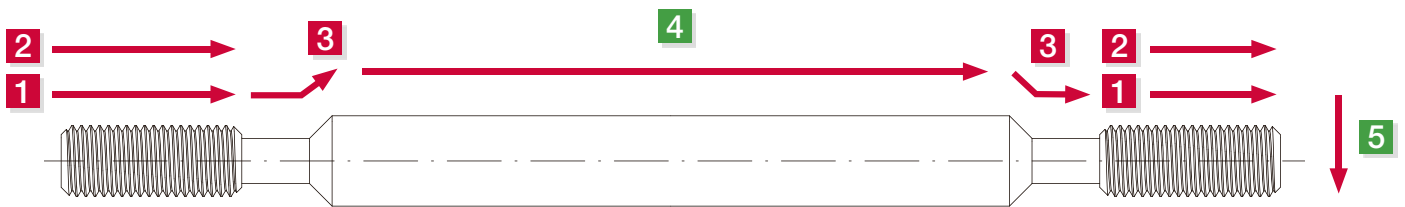

1 Front Turning



**MINIFÜRN
MODUMTUR**
Holder : QC-1212X-CHP
Head : QC12-JSDJ2XR07-CHP
Insert : DXGU070302MFL-JS SH725

2 Threading



**TETRAMCUT
MODUMTUR**
Holder : QC-1212X-CHP
Head : QC12-STCR18-CHP
Insert : TCT18FR-60A-010 SH725

3 Front Turning



**MINIFÜRN
MODUMTUR**
Holder : QC-1212X-CHP
Head : QC12-JSDNXR07-CHP
Insert : DXGU070302MFL-JS SH725

4 Front Turning with Vibration Cutting



TMV Chipbreaker

Holder : QC-1212X-CHP
Holder : QC12-JSDJ2CR11-CHP
Insert : DCGT11T301MRTMV TM4

5 Parting off

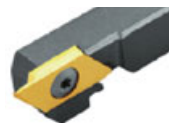

CTP Series

Holder : CTPR12H-OH2
Insert : CTP10FRN-CX

Grade	1
Insert	2
External Toolholder	3
Internal Toolholder	4
Threading Tool	5
Parting, Grooving	6
Shaper	7
Endmill	8
Drilling Tool	9
Technical Reference	10

Grade	1
Insert	2
Ext. Toolholder	3
Int. Toolholder	4
Threading	5
Grooving	6
Shaper	7
Endmill	8
Drilling Tool	9
Technical Reference	10

1. Grade

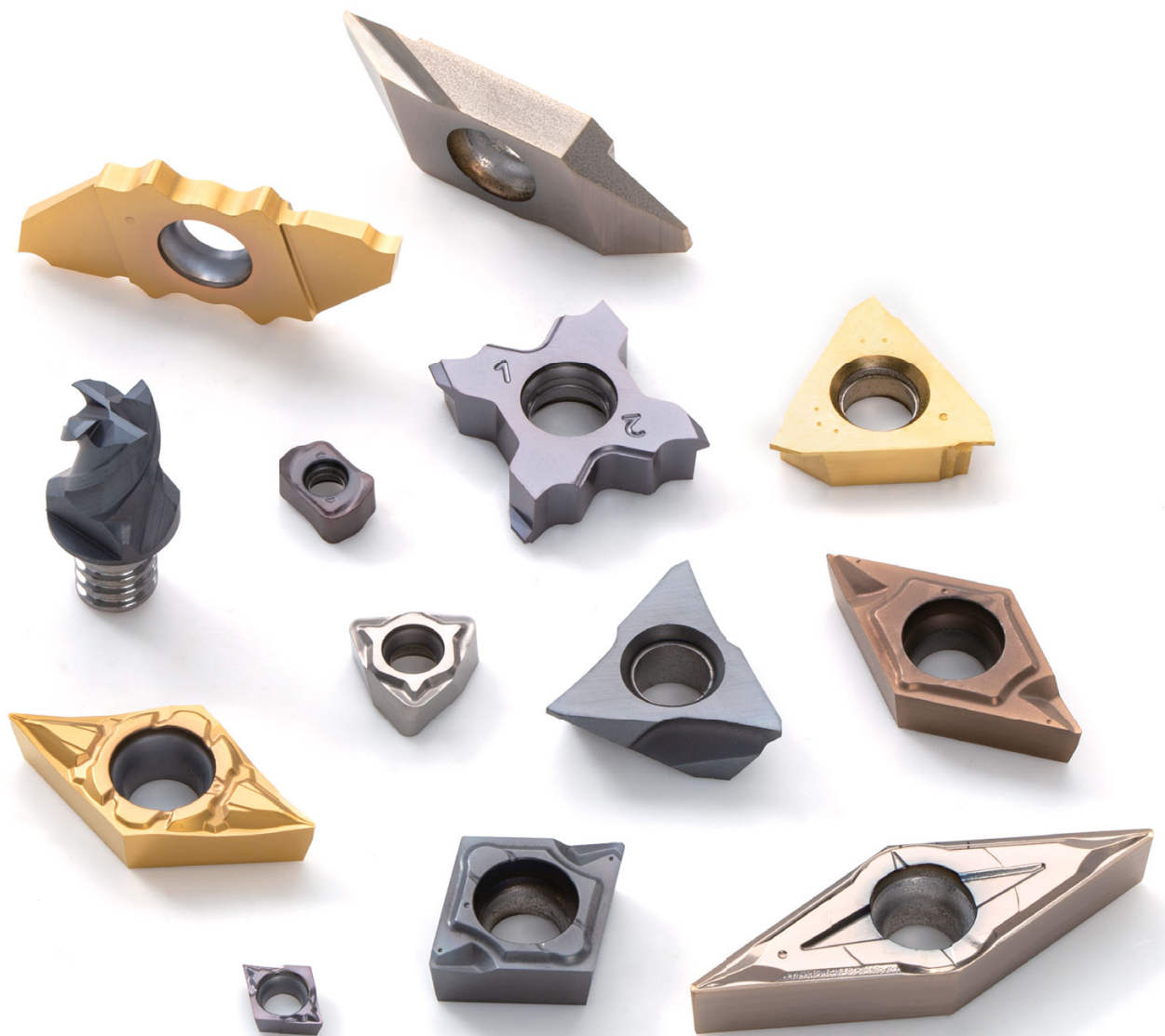

Grade

Quick Guide

1-2

Coated Grade / PVD

1-3

Coated Grade / CVD

1-5

Cermet

1-5

CBN

1-6

PCD

1-6

Diamond Coating

1-7

Cemented Carbide

1-7

Grade - Quick Guide

Grade selection

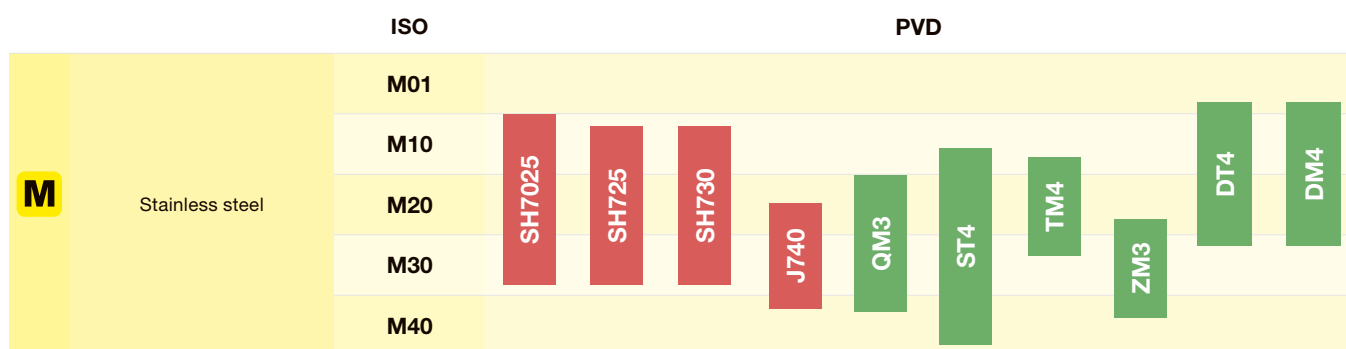
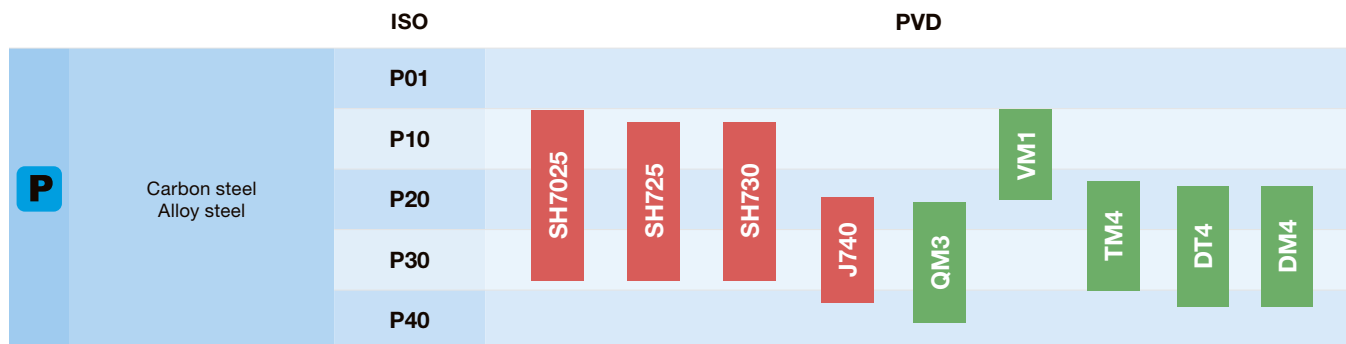

Grade and Chipbreaker comparison chart

P M	Coated Carbide		Chipbreaker	
	05 - 15	15 - 25	Finish	Finish to Medium
Tungaloy & NTK	SH7025 / SH725 ST4 / VM1 / DM4 / DT4	SH7025 / SH725 ST4 / QM3 / TM4 / ZM3 DM4 / DT4	JP / 01 AMX / AZ7	JS YL / AM3 / CL
Sandvik	GC1105 / GC1115	GC1125	UF	UM
Kennametal	KC5010 / KCU10	KC5025	FP	LF
Seco	CP200 / CP250	CP500	FF1	F1
ARNO	AL10 / AM5010	AL20 / AM5020 AM5025	AEC / ASF	PS / ACB / ALU
Applitec	TiALN / TiN / HTA	TiALN / TiN / HTA	FN-X8/17/25	ENP-X8/17/25
Sumitomo	AC1030U / AC520U / ACZ150	AC1030U	FC	SI SC
Mitsubishi	VP10RT / VP15TF / MC6015	VP15TF	FV / FP	LP / SV SMG
Kyocera	PR1705 / PR1725 PR1225 / PR930 / PR015S	PR1535	CF SKS	GF / GQ SK / CK
ZCC-CT	YBG102 / YBG202	YBG202	LH	USF
Korloy	PC8110 / PC5300	PC5300	FS	MS
ISCAR	IC908 / IC830 / IC1008 / IC1007	IC908 / IC830 / IC1008 / IC1007	PF	WF F1M-20P/12P
TaeguTec	TT4410	TT4430	SL-F	SM-F / SH-F

Note: The above table is selected from a publication. We have not obtained approval from each company.

PVD - Coated Grade

Grade	Coating		Application	Feature
	Main composition	Thickness / μm		
AH120	(Ti, Al)N	3	P M S	- Good balance between wear and fracture resistance - Suitable for machining steel, stainless steel, and cast iron under general cutting conditions
AH130	(Ti, Al)N	3	P M	- High chipping and fracture resistance - Designed for machining austenitic stainless steel under general cutting conditions
AH3225	(Ti, Al)SiCrN	5	P M	- Good balance between wear and fracture resistance - Suitable for steel and stainless steel
AH3135	(Ti, Al)N	4	P M	- High fracture resistance - Suitable for machining steel and stainless steel under general cutting conditions
AH6225	(Ti, Al)N	6	P M	- First recommendation PVD grade for stainless steel machining - A versatile PVD grade for excellent performance in a wide range of stainless steel applications
AH6030	(Ti, Al)N	5	M S	- High fracture resistance - Suitable for drilling stainless steel and heat-resistant alloy under general cutting conditions
AH6235	(Ti, Al)N	6	P M	- Provides high reliability in interrupted cutting with large depths of cut
AH710	(Ti, Al)N	3	P H	- High wear resistance - Suitable for finishing cast iron and high-hardened steel
AH7025	(Ti, Al)N	3.5	P M S	- Excellent wear resistance and high rigidity - First recommendation for grooving of various materials
AH725	(Ti, Al)N	2	P M S	- Good balance between wear and chipping resistance - Suitable for machining steel and stainless steel under general cutting conditions
AH750	(Ti, Al)N	3	H	- High wear resistance - Designed for milling high-hardened material
AH8005	(Al,Ti)N	3.5	M S H	- Good resistance to wear and adhesion - Excellent performance in machining heat-resistant alloy at high speed
AH8015	(Al,Ti)N	3.5	P M S H	- Good balance between wear and fracture resistance - First recommendation for machining heat-resistant alloy under general cutting conditions - First recommendation for threading
AH905	(Al, Ti)N	1.5	S	- High resistance to wear and built-up edge
AH9130	(Ti, Al)SiCrN	4.5	P M S	- High wear resistance - Designed for drilling various materials
AH9030	(Ti, Al)N	5	P	- High wear resistance - Suitable for drilling steel and cast iron at high speed
GH110	Ti(C, N, O)	3	P M N S	- High wear resistance
GH130	Ti(C, N, O)	3	P M	- High chipping and fracture resistance - Suitable for steel, stainless steel, and cast iron
GH330	Ti(C, N, O)	3	P M	- High resistance to wear and fracture - Suitable for continuous to medium interrupted cutting
GH730	Ti(C, N, O)	3	P M	- High wear resistance - Suitable for turning and grooving at low speed
J740	TiN	1	For swiss lathes	- Ultra-fine-grain cemented carbide coated with TiN-based compound

Grade

Insert

Ext. Toolholder

Int. Toolholder

Threading

Grooving

Shaper

Endmill

Drilling Tool

Technical Reference

1

2

3

4

5

6

7

8

9

10

PVD - Coated Grade

Grade	Coating		Applica- tion	Feature
	Main composition	Thickness / μm		
SH7025	TiCN / (Ti,Al)N	2	P M	- First recommendation for small part machining. - Superior surface quality and process security. - High wear resistance and excellent fracture resistance.
SH725	(Ti, Al)N	2	P M	- High wear resistance - Designed for machining steel and stainless steel
SH730	(Ti, Al)N	1	P M S	- High wear resistance - Designed for machining steel, stainless steel, and difficult-to-cut material
YH170	Ti(C, N)	1.5	P M	- High resistance to wear and fracture - Designed for drilling carbon steel and stainless steel
YH180	Ti(C, N)	1.5	P M	- High wear resistance - Designed for drilling carbon steel and stainless steel

PVD - Coated Grade

Grade	Coating		Applica- tion	Feature
	Main composition	Thickness / μm^*		
NTK650	TiAlN	3	S	- Stable machining of [Ni base alloys \times small diameter parts] for all users
ST4	CrAlN	2.5	M	- First recommendation for stainless steel. - Higher hardness and oxidation resistance by unique coating technology
DM4	TiAlN	3	P M S	- Best oxidation resistance enables high temperature machining cutting such as parting and grooving.
DT4	TiAlN	1	P M S	- Combination of sharp cutting edge and excellent oxidation resistance - Best grade for difficult-to-cut materials / Titanium alloys
TM4	TiN-TiCN	1.5	P M N S	- Best grade for general purpose - Best combination of wear resistance, toughness and adhesion resistance
QM3	TiCN	3	P M	- Designed for machining carbon and alloy steels - High wear resistance
ZM3	TiN	3	P M N	- Excellent adhesion resistance - Suitable for high-precision machining of small diameter workpieces
VM1	TiCN	1	P	- First recommendation for free-cutting steel - Reducing the built up edge on the cutting edge

* centralvalue

CVD - Coated Grade

Grade	Coating		Application	Feature
	Main composition	Thickness / μm		
T9205	Ti compound +Al ₂ O ₃	18	P	- High wear resistance - Excellent performance in high-speed cutting
T9215	Ti compound +Al ₂ O ₃	18	P M	- Well-balanced between wear and chipping resistance - First recommendation for steel - High versatility for a wide range of applications
T9225	Ti compound +Al ₂ O ₃	18	P M	- First recommendation for roughing to medium cutting - High fracture resistance
T9235	Ti compound +Al ₂ O ₃	18	P	- High fracture resistance in heavy interrupted cutting
T6215	TiCN-Al ₂ O ₃	8	P M	- High wear resistance at medium to high speed machining - First recommendation CVD grade for stainless steel cutting
T6120	TiCN	6	P M	- Excellent wear resistance in high-speed continuous cutting
T6130	TiCN	6	P M	- High wear resistance at medium to high speed machining
T313V	TiCN-Al ₂ O ₃	3	Threading	- High resistance to plastic deformation

Cermet

Grade	Coating		Application	Feature
	Main composition	Thickness / μm		
NS520	Uncoated	-	P	- High wear resistance
NS9530	Uncoated	-	P	- High fracture resistance - Suitable for finishing to medium cutting of steel
AT9530	(Ti,Al)N laminated coating	3	P	- High wear resistance - First recommendation for machining alloy steel
GT9530	Ti(C, N, O)	3	P	- High wear resistance - Excellent surface quality in finishing
J9530	TiN	1	For Swiss lathes	- Suitable for small-part machining

Grade

Insert

Ext. Toolholder

Int. Toolholder

Threading

Grooving

Shaper

Endmill

Drilling Tool

Technical Reference

1

2

3

4

5

6

7

8

9

10

CBN

Grade	Hardness (Hv)	T.R.S. (GPa)	Applica- tion	Feature
BXA10	3200 ~ 3400	1.00 ~ 1.10	H	- Coated CBN with excellent performance in continuous cutting with middle speed range for hardened steel
BXM10	2700 ~ 2900	0.80 ~ 0.90	H	- Coated CBN for excellent performance in high-speed continuous cutting of hardened steel
BX310	2700 ~ 2900	0.80 ~ 0.90	H	- High wear resistance - Designed for high-speed continuous cutting of hardened steel
BXA20	3300 ~ 3500	1.30 ~ 1.50	H	- Coated CBN for excellent performance in machining hardened steel
BXM20	3500 ~ 3700	1.35 ~ 1.50	H	- Coated CBN for machining hardened steel in a wide range of application area
BX360	3200 ~ 3400	1.00 ~ 1.10	H	- Suitable for general machining of hardened steel
BR35F	3100 ~ 3300	1.40 ~ 1.60	H	- Coated CBN with outstanding fracture resistance in heavy-interrupted machining of hardened steel
BX330	2800 ~ 3000	0.85 ~ 0.95	H	- Excellent sharpness - Designed for finishing hardened steel
BX470	4100 ~ 4300	1.90 ~ 2.10	Sintered metal	- Excellent sharpness - Suitable for ferrous sintered metal
BX480	4100 ~ 4300	1.90 ~ 2.10	Sintered metal	- Hardest CBN - Ideal for ferrous sintered metal - Suitable for high-speed face milling of cast iron
BX815	3000 ~ 3200	1.00 ~ 1.10	S	- High wear resistance and thermo stability - Suitable for high-speed machining of Inconel

PCD

Grade	Grain size (µm)	Hardness (Hv)	T.R.S. (GPa)	Applica- tion	Feature
DX110	< 1	8500	1.8	N	- Excellent sharpness for high surface quality - Suitable for finishing non-ferrous metal and nonmetal
DX120	4.5	9000	1.8	N	- Suitable for finishing non-ferrous metal and nonmetal
DX140	12.5	10000	1.7	N	- High wear resistance - Designed for machining non-ferrous metal and nonmetal
DX160	28	11000	1.6	N	- Designed for machining ceramic, cemented carbide, and nonmetal

PCD

Grade	Component	Grain size(μm)	Applica- tion	Feature
PD1	Diamond sintered	10	N	- Designed for non-ferrous metal
PD2	Diamond sintered	1	N	- Improved sharpness and chipping resistance

Diamond Coating

Grade	Coating		Applica- tion	Feature
	Component	Grain size(μm)		
UC1	Diamond Coating	0.1	N	- For Non-ferrous metal machining - Wear resistance is improved compared to PCD tools

Cemented Carbide

Grade	Hardness (HRA)	T.R.S. (GPa)	Application
KS05F	93.0	2.9	S N
TH10	92.0	2.4	P M N
KS15F	91.5	3.0	N
UX30	91.1	2.3	P M

Cemented Carbide

Grade	Hardness (HRA)	T.R.S. (GPa)	Application
KM1	92.0	2.5	N

Grade

1

Insert

2

Ext. Toolholder

3

Int. Toolholder

4

Threading

5

Grooving

6

Shaper

7

Endmill

8

Drilling Tool

9

Technical Reference

10

2. Insert

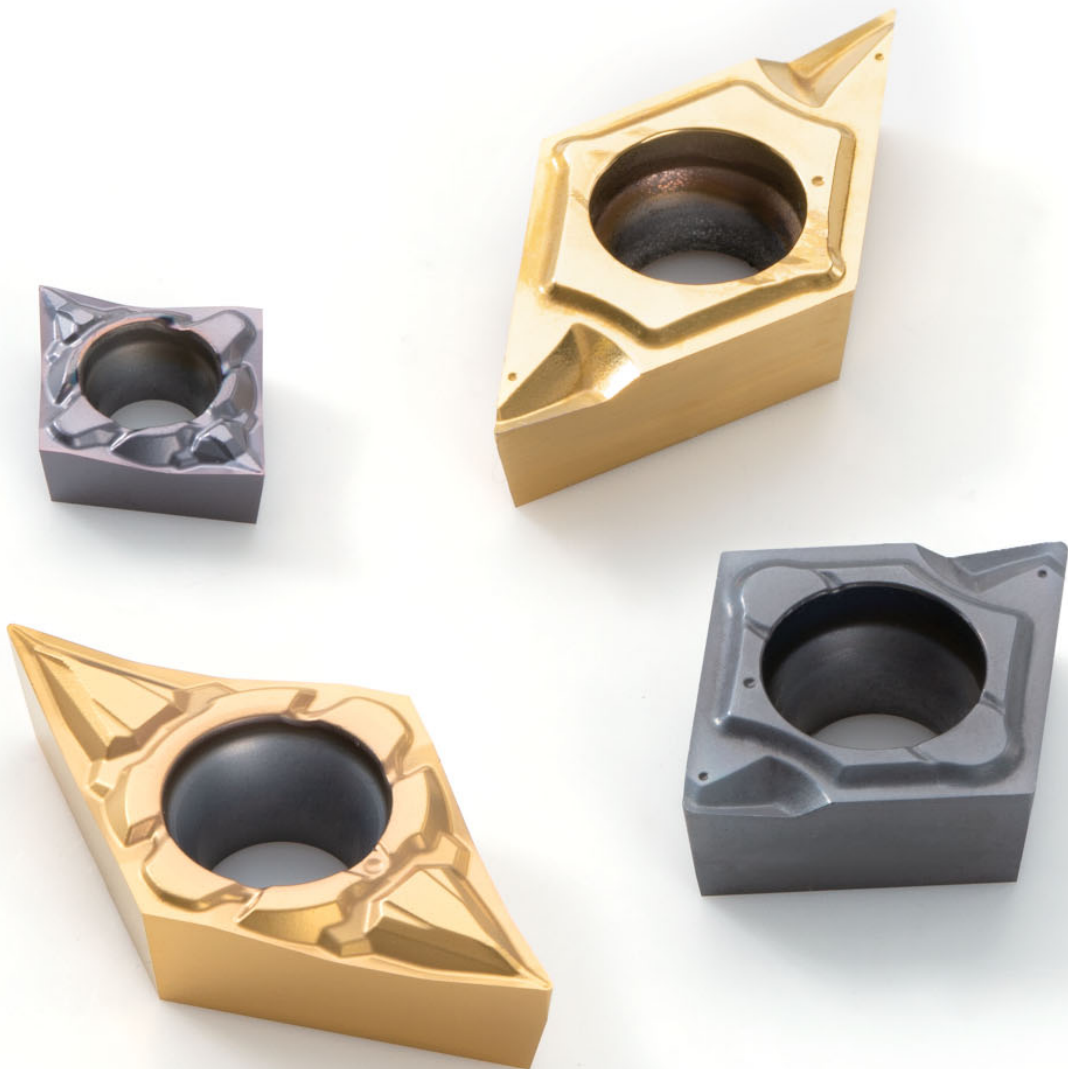

Insert

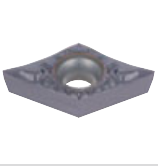

Positive type

Coated CVD/PVD, Cermet, Uncoated cemented carbide

2-11

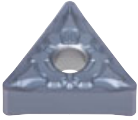

Negative type

Coated CVD/PVD, Cermet, Uncoated cemented carbide

2-60

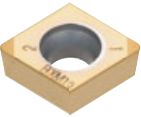

CBN / PCD Insert

CBN, PCD

2-87

Chipbreaker Guide

Basic chipbreaker for Miniature machining

P M S

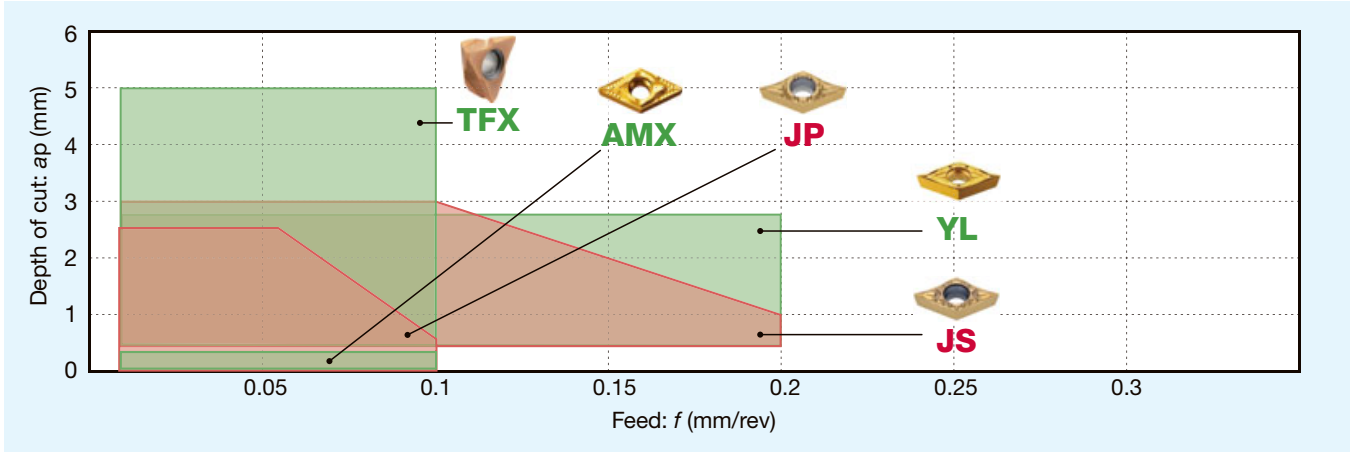

N

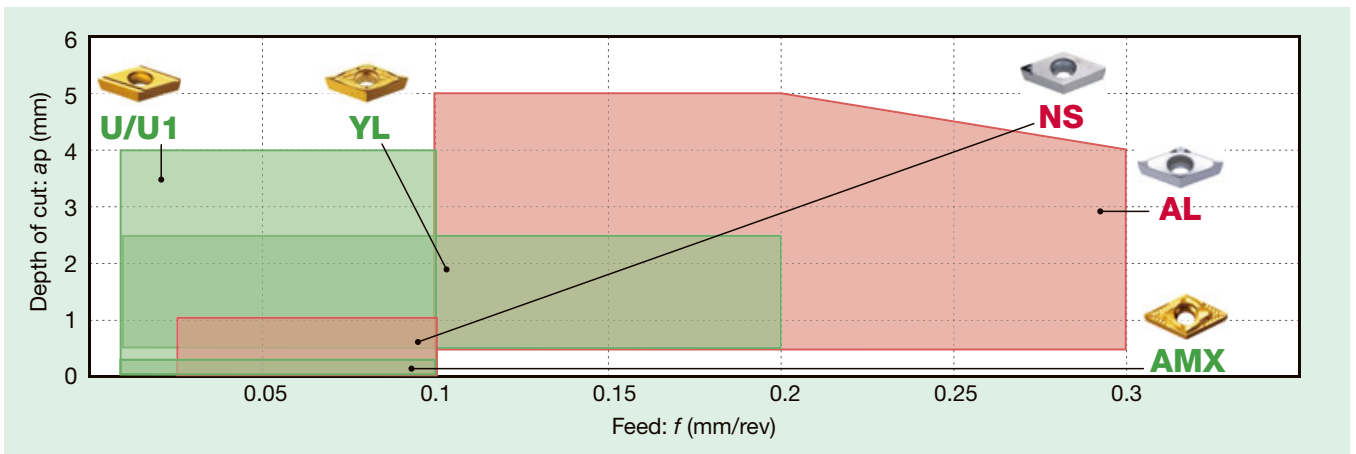



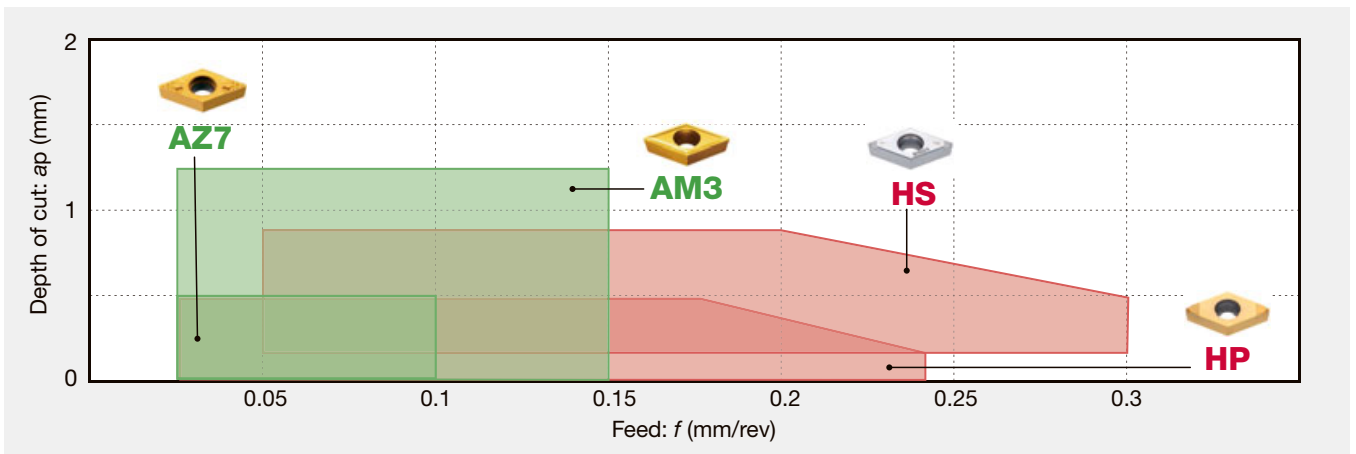

















H



Selection System

Selection system for Miniature machining

P M S  Continuous  Interrupted

	Continuous	Interrupted
Precision finishing to Finishing ($ap \approx 0.05 \sim 0.5 \text{ mm}$)	 P SH7025 / SH725 M SH7025 / SH725 S SH7025 / SH725	 P SH7025 / SH725 M SH7025 / SH725 S SH7025 / SH725
	 P QM3 M ST4 S 650 / DT4	 P QM3 M QM3 S 650 / DT4
Finishing to Medium cutting ($ap \approx 0.5 \sim 1 \text{ mm}$)	 P SH7025 / SH725 M SH7025 / SH725 S SH7025 / SH725	 P SH7025 / SH725 M SH7025 / SH725 S SH7025 / SH725
	 P QM3 M ST4 S 650 / DT4	 P QM3 M QM3 S 650 / DT4
Medium cutting ($ap \approx 1 \sim 3 \text{ mm}$)	 P SH7025 / SH725 M SH7025 / SH725 S SH7025 / SH725	 P SH7025 / SH725 M SH7025 / SH725 S SH7025 / SH725
	 P QM3 M ST4 S 650 / DT4	 P QM3 M QM3 S 650 / DT4
Finishing to Medium cutting ($ap \approx 1 \text{ mm}$)	 N DX110	 N KS05F
	 N TM4 / ZM3	 N TM4 / ZM3
Finishing to Medium cutting ($ap \approx 1 \text{ mm}$)	 H BXA10	 H BXA20
	 H DM4	 H QM3













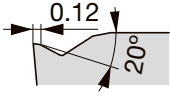
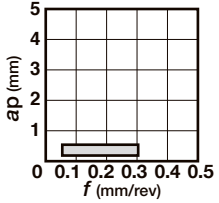

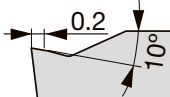
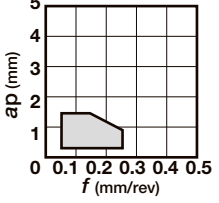
Grade
Insert
Ext. Toolholder
Int. Toolholder
Threading
Grooving
Shaper
Endmill
Drilling Tool
Technical Reference

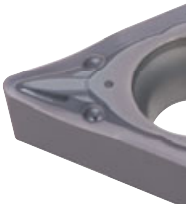
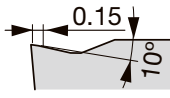
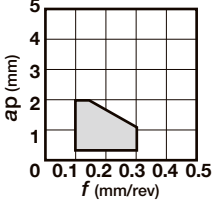

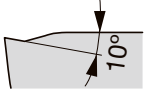
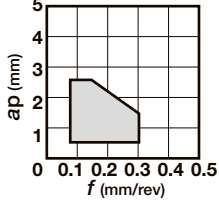
Positive Inserts - Chipbreaker Overview

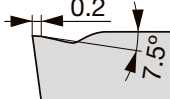
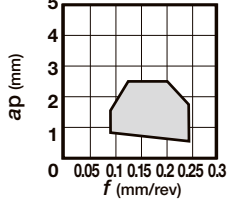
Application	Type	Chipbreaker design	Applicable range
	Precision finishing	JP	
	Precision finishing	01	
	Finishing	JS	
	Precision finishing	JPP	
	Precision finishing	JRP	
	Precision finishing	JSP	
	Finishing to medium cutting	J10	
	Finishing to medium cutting	AL	

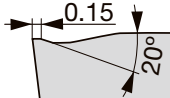
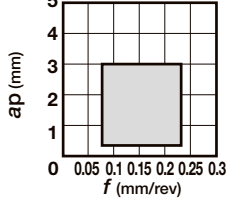
Positive Inserts - Chipbreaker Overview

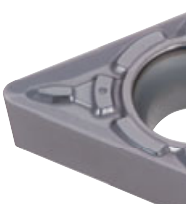
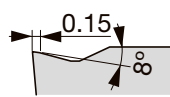
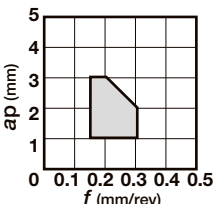









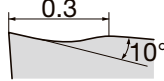
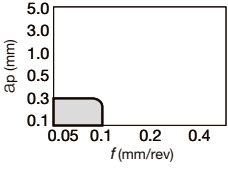

Application	Type	Chipbreaker design	Applicable range
 Finishing	PSF	 	
 Finishing	PF	 	
 Finishing to light cutting	PSS	 	
 Finishing to medium cutting	PS	 	
 Finishing to medium cutting	TSF	 	
 Finishing to medium cutting	TM	 	
 Medium cutting	PM	 	

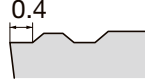
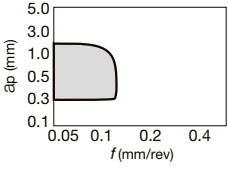
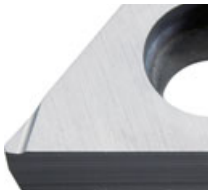
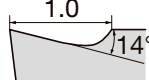
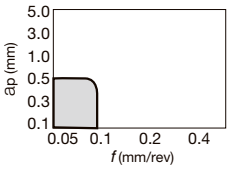
Grade 1
 Insert 2
 Ext. Toolholder 3
 Int. Toolholder 4
 Threading 5
 Grooving 6
 Shaper 7
 Endmill 8
 Drilling Tool 9
 Technical Reference 10

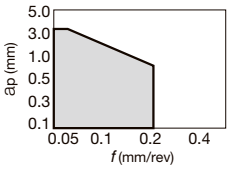
Double-sided positive inserts - Chipbreaker Overview

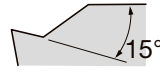
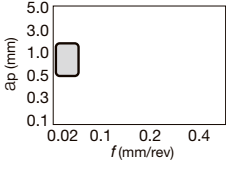

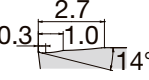
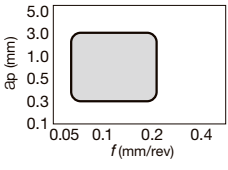
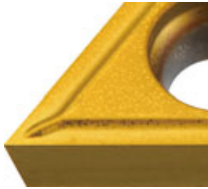
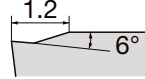
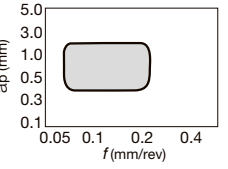

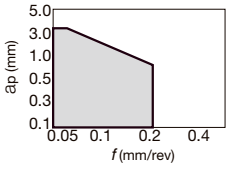



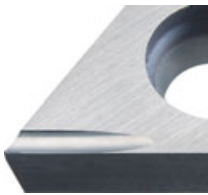
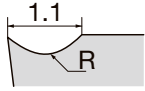
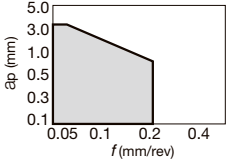

Application		Type	Chipbreaker design		Applicable range
	Precision finishing	JSS			
	Finishing	JS			
	Finishing	JTS			
	Finishing	JRP			
	Finishing	SS			
	Finishing	TSW			
	Finishing	TS			

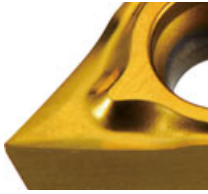
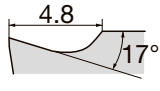
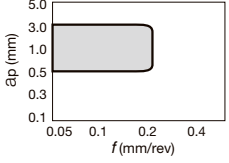
Positive Inserts - Chipbreaker Overview

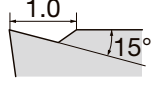
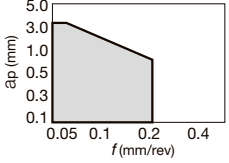
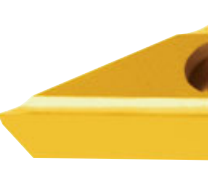
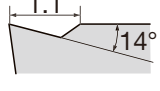

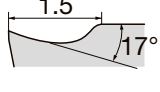
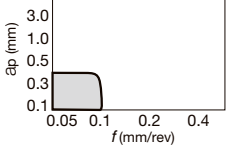

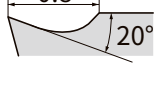
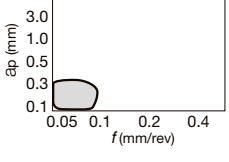

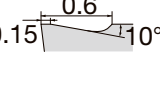
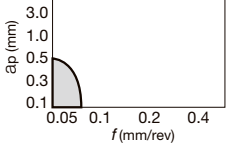
Application	Type	Chipbreaker design	Applicable range
	Finishing	AMX 	 
		AZ7 	 
		KHG 	 
		AT 	 
	Light cut	TMV 	 
		YL 	 
		AM3 	 
		U U1 	 

Grade 1
 Insert 2
 Ext. Toolholder 3
 Int. Toolholder 4
 Threading 5
 Grooving 6
 Shaper 7
 Endmill 8
 Drilling Tool 9
 Technical Reference 10

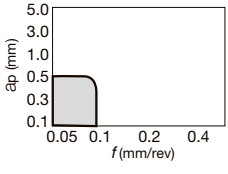
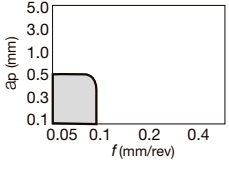
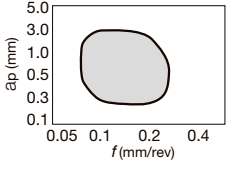
Positive Inserts - Chipbreaker Overview

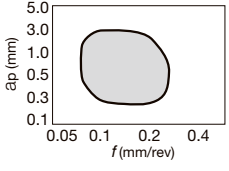
Application		Type	Chipbreaker design		Applicable range
P M N S	Light cut	UHG			
		V P H	 <p>Topside Flank side</p>		
P M N S	Middle Cut	CL			
		S			
		SX			
P M N S	Internal Finishing	FG			
		A2			
		B1			

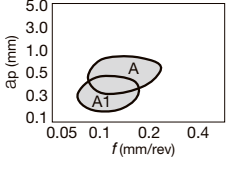
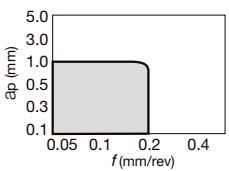
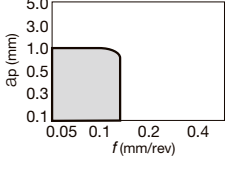
Positive Inserts - Chipbreaker Overview

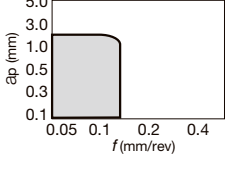
Application	Type	Chipbreaker design	Applicable range
P M N S	Internal Finishing	K 	
		AM5 	
P M N S	Internal Middle Cut	F1 F05 	
		A A1 	
P M N S	Internal Middle Cut	B2 	
		B3 	

Grade

Insert

Ext. Toolholder

Int. Toolholder

Threading

Grooving

Shaper

Endmill

Drilling Tool

Technical Reference

Negative Inserts - Chipbreaker Overview

Application		Type	Chipbreaker design		Applicable range
	Finishing	D1			
	Middle Cut	ZP			
	Finishing	UL			

Insert POSITIVE TYPE

- : Continuous cutting
- ◐ : Light interrupted cutting
- ◑ : Heavy interrupted cutting

CC



Rhombic, 80° with hole Positive 7°

P Steel	●	◐	◐	◐	◐																
M Stainless	●	◐	◐	◐	◐																
N Non-ferrous	●	◐	◐	◐	◐																
S Superalloy	●	◐	◐	◐	◐																
H Hard material																					

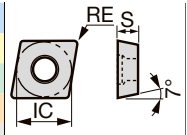

Application	Chipbreaker	Designation	Coated					Dimension (mm)		
			AH725	SH7025	SH725	SH730	J740	RE	IC	S
Precision finishing (sharp edge)		JP CCGT060200FN-JP	●	●				<0.05	6.35	2.38
		CCGT060201FN-JP	●	●				<0.1	6.35	2.38
		CCGT060202FN-JP	●	●				<0.2	6.35	2.38
		CCGT09T300FN-JP	●	●				<0.05	9.525	3.97
		CCGT09T301FN-JP	●	●				<0.1	9.525	3.97
		CCGT09T302FN-JP	●	●				<0.2	9.525	3.97
		01 CCGT060202F-01	●	●				<0.2	6.35	2.38
		CCGT060204F-01	●	●				<0.4	6.35	2.38
		CCGT09T302F-01	●	●				<0.2	9.525	3.97
		CCGT09T304F-01	●	●				<0.4	9.525	3.97
Precision finishing		01 CCGT060202-01				●		0.2	6.35	2.38
		CCGT09T302-01				●		0.2	9.525	3.97
Finishing (sharp edge)		JS CCGT03X101F-JS	●	●				<0.1	3.57	1.39
		CCGT03X102F-JS	●	●				<0.2	3.57	1.39
		CCGT03X104F-JS	●	●				<0.4	3.57	1.39
		CCGT04T101F-JS	●	●				<0.1	4.37	1.79
		CCGT04T102F-JS	●	●				<0.2	4.37	1.79
		CCGT04T104F-JS	●	●				<0.4	4.37	1.79
		JS CCGT060200FN-JS	●	●	●				<0.05	6.35
Finishing		CCGT060201FN-JS	●	●	●			<0.1	6.35	2.38
		CCGT060202FN-JS	●	●	●			<0.2	6.35	2.38
		CCGT060204FN-JS	●	●	●			<0.4	6.35	2.38
		CCGT09T300FN-JS	●	●	●			<0.05	9.525	3.97
		CCGT09T301FN-JS	●	●	●			<0.1	9.525	3.97
		CCGT09T302FN-JS	●	●	●			<0.2	9.525	3.97
		CCGT09T304FN-JS	●	●	●			<0.4	9.525	3.97
		JS CCGT03X101-JS				●			<0.1	3.57
	CCGT03X102-JS				●		<0.2	3.57	1.39	
	CCGT03X104-JS				●		<0.4	3.57	1.39	
	CCGT04T101-JS				●		<0.1	4.37	1.79	
	CCGT04T102-JS				●		<0.2	4.37	1.79	
	CCGT04T104-JS				●		<0.4	4.37	1.79	
	JS CCGT060201N-JS		●					0.1	6.35	2.38
	CCGT060202N-JS		●				0.2	6.35	2.38	
	CCGT060204N-JS		●				0.4	6.35	2.38	
	CCGT09T301N-JS		●				0.1	9.525	3.97	
	CCGT09T302N-JS		●				0.2	9.525	3.97	
	CCGT09T304N-JS		●				0.4	9.525	3.97	

*Corner radius (RE) with a sign of inequality (<) means minus tolerance.

● : Line up

Reference pages: External toolholder → 3-29 -, Internal toolholder → 4-12 -

Insert POSITIVE TYPE

- : Continuous cutting
- ◐ : Light interrupted cutting
- ✱ : Heavy interrupted cutting

CC

**Rhombic, 80°
with hole
Positive 7°**

	P	M	N	S	H	T9215	T9225	T6215	AH8005	AH8015	AH6225	AH725	SH7025	SH725	GH730	J740	GT9530	NS9530	TH10	
Steel	●	●	●	●	●	●	●	●	●	●	●	●	●	●	●	●	●	●	●	●
Stainless	●	●	●	●	●	●	●	●	●	●	●	●	●	●	●	●	●	●	●	●
Non-ferrous	●	●	●	●	●	●	●	●	●	●	●	●	●	●	●	●	●	●	●	●
Superalloy	●	●	●	●	●	●	●	●	●	●	●	●	●	●	●	●	●	●	●	●
Hard material	●	●	●	●	●	●	●	●	●	●	●	●	●	●	●	●	●	●	●	●

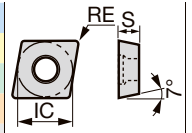

Application	Chipbreaker	Designation	Coated														Coated cermet	Cermet	Uncoated	Dimension (mm)					
			T9215	T9225	T6215	AH8005	AH8015	AH6225	AH725	SH7025	SH725	GH730	J740	GT9530	NS9530	TH10	RE	IC	S						
PSF		CCMT060202-PSF																●			0.2	6.35	2.38		
		CCMT060204-PSF	●	●		●	●	●										●	●			0.4	6.35	2.38	
		CCMT09T302-PSF																		●			0.2	9.525	3.97
		CCMT09T304-PSF	●	●		●	●	●											●	●			0.4	9.525	3.97
		CCMT09T308-PSF	●	●															●	●			0.8	9.525	3.97
PF		CCMT060202-PF																●	●			0.2	6.35	2.38	
		CCMT060204-PF								●									●	●			0.4	6.35	2.38
		CCMT060208-PF																	●	●			0.8	6.35	2.38
		CCMT09T302-PF																		●	●		0.2	9.525	3.97
		CCMT09T304-PF																		●	●		0.4	9.525	3.97
CCMT09T308-PF			●															●	●			0.8	9.525	3.97	
TSF		CCMT060202-TSF	●	●	●		●	●											●			0.2	6.35	2.38	
		CCMT060204-TSF	●	●	●		●	●												●			0.4	6.35	2.38
		CCMT060208-TSF	●	●	●		●	●												●			0.8	6.35	2.38
		CCMT09T302-TSF	●	●	●		●	●												●			0.2	9.525	3.97
		CCMT09T304-TSF	●	●	●		●	●												●			0.4	9.525	3.97
CCMT09T308-TSF	●	●	●		●	●												●				0.8	9.525	3.97	
J10		CCGT060200FR-J10											●	●						●		0.03	6.35	2.38	
		CCGT060200FL-J10													●	●					●		0.03	6.35	2.38
		CCGT060201FR-J10														●	●			●			0.1	6.35	2.38
		CCGT060201FL-J10															●	●			●		0.1	6.35	2.38
		CCGT060202FR-J10																		●	●		0.2	6.35	2.38
		CCGT060202FL-J10																		●	●		0.2	6.35	2.38
		CCGT09T300FR-J10																			●		0.03	9.525	3.97
		CCGT09T300FL-J10																			●		0.03	9.525	3.97
		CCGT09T301FR-J10																			●		0.1	9.525	3.97
		CCGT09T301FL-J10																			●		0.1	9.525	3.97
		CCGT09T302FR-J10																			●		0.2	9.525	3.97
		CCGT09T302FL-J10																			●		0.2	9.525	3.97
		CCGT09T304FR-J10																					0.4	9.525	3.97

*Corner radius (RE) with a sign of inequality (<) means minus tolerance.

● : Line up

Insert POSITIVE TYPE

- : Continuous cutting
- ◐ : Light interrupted cutting
- ◑ : Heavy interrupted cutting

CC



**Rhombic, 80°
with hole
Positive 7°**

Material	Steel	Stainless	Non-ferrous	Superalloy	Hard material	Coated	Coated cermet	Cermet	Uncoated
P	●●●●●●●●	●●●●●●●●	●●●●●●●●	●●●●●●●●	●●●●●●●●	●●●●●●●●	●●●●●●●●	●●●●●●●●	●●●●●●●●
M	●●●●●●●●	●●●●●●●●	●●●●●●●●	●●●●●●●●	●●●●●●●●	●●●●●●●●	●●●●●●●●	●●●●●●●●	●●●●●●●●
N	●●●●●●●●	●●●●●●●●	●●●●●●●●	●●●●●●●●	●●●●●●●●	●●●●●●●●	●●●●●●●●	●●●●●●●●	●●●●●●●●
S	●●●●●●●●	●●●●●●●●	●●●●●●●●	●●●●●●●●	●●●●●●●●	●●●●●●●●	●●●●●●●●	●●●●●●●●	●●●●●●●●
H	●●●●●●●●	●●●●●●●●	●●●●●●●●	●●●●●●●●	●●●●●●●●	●●●●●●●●	●●●●●●●●	●●●●●●●●	●●●●●●●●

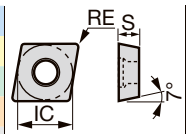

Application	Chipbreaker	Designation	Coated		Coated cermet	Cermet	Uncoated		Dimension (mm)				
			SH7025	SH725	SH730	GH330	GH110	GT9530	NS9530	TH10	UX30	RE	IC
Finishing (sharp edge)	W08	CCGT03X100FL-W08	●	●							0.03	3.57	1.39
		CCGT03X100FR-W08		●							0.03	3.57	1.39
		CCGT03X101FL-W08	●	●							0.1	3.57	1.39
		CCGT03X101FR-W08		●							0.1	3.57	1.39
		CCGT03X102FL-W08	●	●							0.2	3.57	1.39
		CCGT03X102FR-W08	●	●							0.2	3.57	1.39
		CCGT03X104FL-W08	●	●							0.4	3.57	1.39
		CCGT03X104FR-W08	●	●							0.4	3.57	1.39
		CCGT04T100FL-W08	●	●							0.03	4.37	1.79
		CCGT04T100FR-W08		●							0.03	4.37	1.79
		CCGT04T101FL-W08	●	●							0.1	4.37	1.79
		CCGT04T101FR-W08		●							0.1	4.37	1.79
		CCGT04T102FL-W08	●	●							0.2	4.37	1.79
		CCGT04T102FR-W08	●	●							0.2	4.37	1.79
		CCGT04T104FL-W08	●	●							0.4	4.37	1.79
		CCGT04T104FR-W08	●	●							0.4	4.37	1.79
Finishing	W08	CCGT03X100R-W08		●				●			0.03	3.57	1.39
		CCGT03X100L-W08		●				●			0.03	3.57	1.39
		CCGT03X101R-W08		●				●			0.1	3.57	1.39
		CCGT03X101L-W08		●				●			0.1	3.57	1.39
		CCGT03X102R-W08		●				●			0.2	3.57	1.39
		CCGT03X102L-W08		●				●			0.2	3.57	1.39
		CCGT03X104R-W08		●				●			0.4	3.57	1.39
		CCGT03X104L-W08		●				●			0.4	3.57	1.39
		CCGT04T100R-W08		●				●			0.03	4.37	1.79
		CCGT04T100L-W08		●				●			0.03	4.37	1.79
		CCGT04T101R-W08		●				●			0.1	4.37	1.79
		CCGT04T101L-W08		●				●			0.1	4.37	1.79
		CCGT04T102R-W08		●				●			0.2	4.37	1.79
		CCGT04T102L-W08		●				●			0.2	4.37	1.79
		CCGT04T104R-W08		●				●			0.4	4.37	1.79
		CCGT04T104L-W08		●				●			0.4	4.37	1.79
Finishing	W15	CCGT060200R-W15						●			0.03	6.35	2.38
		CCGT060200L-W15						●			0.03	6.35	2.38
		CCGT060202R-W15						●			0.2	6.35	2.38
		CCGT060202L-W15				●		●			0.2	6.35	2.38
		CCGT060204R-W15			●			●			0.4	6.35	2.38
		CCGT060204L-W15			●	●		●	●		0.4	6.35	2.38

● : Line up

Reference pages: External toolholder → 3-29 -, Internal toolholder → 4-12 -

Grade
Insert
Ext. Toolholder
Int. Toolholder
Threading
Grooving
Shaper
Endmill
Drilling Tool
Technical Reference

Insert POSITIVE TYPE

- : Continuous cutting
- ◐ : Light interrupted cutting
- ✱ : Heavy interrupted cutting

CC

**Rhombic, 80°
with hole
Positive 7°**

	P	M	N	S	H	Steel	Stainless	Non-ferrous	Superalloy	Hard material	Coated	Coated cermet	Cermet	Uncoated	Dimension (mm)
●	●	●	●	●	●	●	●	●	●	●	●	●	●	●	●
◐	◐	◐	◐	◐	◐	◐	◐	◐	◐	◐	◐	◐	◐	◐	◐
✱	✱	✱	✱	✱	✱	✱	✱	✱	✱	✱	✱	✱	✱	✱	✱

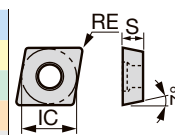

Application	Chipbreaker	Designation	Coated											Coated cermet	Cermet	Uncoated	Dimension (mm)									
			T9215	T9225	T6215	T505	T515	T5115	AH8005	AH8015	AH6225	AH6235	AH725	AH120	GH730	GH330	GH110	GT9530	AT9530	NS9530	TH10	RE	IC	S		
Finishing		W20 CCGT09T302R-W20																		●		0.2	9.525	3.97		
		CCGT09T302L-W20																			●		0.2	9.525	3.97	
		CCGT09T304R-W20																			●		0.4	9.525	3.97	
		CCGT09T304L-W20																			●		0.4	9.525	3.97	
		CCGT09T308R-W20																			●		0.8	9.525	3.97	
		CCGT09T308L-W20																			●		0.8	9.525	3.97	
Finishing to medium cutting		PSS CCMT060204-PSS	●	●	●															●		0.4	6.35	2.38		
		CCMT060208-PSS	●	●	●																●		0.8	6.35	2.38	
		CCMT09T304-PSS	●	●	●																●		0.4	9.525	3.97	
		CCMT09T308-PSS	●	●	●																●		0.8	9.525	3.97	
		CCMT120404-PSS	●	●	●																		0.4	12.7	4.76	
		CCMT120408-PSS	●	●	●																		0.8	12.7	4.76	
		CCMT120412-PSS	●	●	●																		1.2	12.7	4.76	
		PS CCMT060202-PS	●	●	●																	●		0.2	6.35	2.38
		CCMT060204-PS	●	●	●																	●		0.4	6.35	2.38
		CCMT060208-PS	●	●	●																	●		0.8	6.35	2.38
Finishing to medium cutting		PS CCMT09T302-PS	●	●	●															●		0.2	9.525	3.97		
		CCMT09T304-PS	●	●	●																●		0.4	9.525	3.97	
		CCMT09T308-PS	●	●	●																●		0.8	9.525	3.97	
		CCMT120404-PS	●	●	●																		0.4	12.7	4.76	
		CCMT120408-PS	●	●	●																		0.8	12.7	4.76	
		CCMT120412-PS	●	●	●																		1.2	12.7	4.76	
Finishing to medium cutting		TM CCMT060202-TM	●	●	●															●		0.2	6.35	2.38		
		CCMT060204-TM	●	●	●																●		0.4	6.35	2.38	
		CCMT060208-TM	●	●	●																●		0.8	6.35	2.38	
		CCMT09T302-TM	●	●	●																●		0.2	9.525	3.97	
		CCMT09T304-TM	●	●	●																●		0.4	9.525	3.97	
		CCMT09T308-TM	●	●	●																●		0.8	9.525	3.97	

● : Line up

Insert POSITIVE TYPE

- : Continuous cutting
- ◐ : Light interrupted cutting
- ✱ : Heavy interrupted cutting

CC



**Rhombic, 80°
with hole
Positive 7°**

Material	Coated	Cermet	Uncoated
P Steel	● ● ✱	● ●	●
M Stainless	● ●		● ●
N Non-ferrous			● ●
S Superalloy			●
H Hard material			

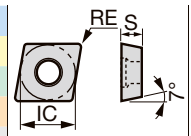

Application	Chipbreaker	Designation	Coated			Cermet	Uncoated		Dimension (mm)			
			T9215	T9225	T5115	NS9530	TH10	KS05F	RE	IC	S	
Finishing to light cutting for non-ferrous metal		AL CCGT060202-AL						●	0.2	6.35	2.38	
		CCGT060204-AL						●	0.4	6.35	2.38	
		CCGT09T302-AL						●	0.2	9.525	3.97	
		CCGT09T304-AL						●	0.4	9.525	3.97	
		CCGT09T308-AL						●	0.8	9.525	3.97	
		CCGT120402-AL						●	0.2	12.7	4.76	
		CCGT120404-AL						●	0.4	12.7	4.76	
		CCGT120408-AL						●	0.8	12.7	4.76	
Finishing to medium cutting		SW CCMT060204-SW	● ●			●			0.4	6.35	2.38	
		CCMT060208-SW	● ●			●			0.8	6.35	2.38	
		CCMT09T304-SW	● ●			●			0.4	9.525	3.97	
		CCMT09T308-SW	● ●			●			0.8	9.525	3.97	
		*Wiper										
		All-round CCGT060202				●				0.2	6.35	2.38
		CCGT060204				●				0.4	6.35	2.38
		CCGT09T302				●				0.2	9.525	3.97
		CCGT09T304				●				0.4	9.525	3.97
		CCGT09T308				●				0.8	9.525	3.97
		Angular CCGT060200R						●	0.03	6.35	2.38	
		CCGT060202R						●	0.2	6.35	2.38	
CCGT060202L							●	0.2	6.35	2.38		
CCGT060204L							●	0.4	6.35	2.38		
CCGT09T302R							●	0.2	9.525	3.97		
CCGT09T302L							●	0.2	9.525	3.97		
CCGT09T304R							●	0.4	9.525	3.97		
CCGT09T304L						●	0.4	9.525	3.97			
	23 CCMT060202-23				●				0.2	6.35	2.38	
	CCMT060204-23	●			●				0.4	6.35	2.38	
	CCMT060208-23	●							0.8	6.35	2.38	
	CCMT09T304-23	●			●				0.4	9.525	3.97	
	CCMT09T308-23	●			●				0.8	9.525	3.97	

* Please see Tungaloy General Catalog vol.5 L011 - L015 about the adjustment of the machining program for rounding or taper machining by using SW/FW. Please contact our sales representatives if you have any question.

● : Line up

Insert POSITIVE TYPE

- : Continuous cutting
- ◐ : Light interrupted cutting
- ✱ : Heavy interrupted cutting

CC



Rhombic, 80°
with hole
Positive 7°

Material	650	ST4	DM4	DT4	QM3	TM4	VM1	ZM3
P Steel					●●●●			
M Stainless		●●●●			●●●●			
N Non-ferrous					●●●●			
S Superalloy	●●		●●		●●			
H Hard material		●●			●●			

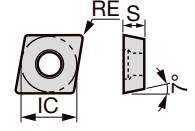

Application	Chipbreaker	Designation	Coated								Dimension (mm)				
			650	ST4	DM4	DT4	QM3	TM4	VM1	ZM3	RE	IC	S		
Application		AZ7 CCGT060200AZ7					●					0.03	6.35	2.38	
		CCGT060201MAZ7					●					0.08	6.35	2.38	
		CCGT060202MAZ7					●					0.18	6.35	2.38	
		CCGT09T300AZ7				●	●	●		●		0.03	9.525	3.97	
		CCGT09T301MAZ7				●	●	●		●		0.08	9.525	3.97	
		CCGT09T302MAZ7				●	●	●		●		0.18	9.525	3.97	
		CCGT09T304MAZ7				●	●	●		●		0.38	9.525	3.97	
Finishing		KHG CCET0602005RKHG								●		0.05	6.35	2.38	
		CCET0602005LKHG								●		0.05	6.35	2.38	
		CCET0602008RKHG									●		0.08	6.35	2.38
		CCET0602008LKHG									●		0.08	6.35	2.38
		CCET0602018RKHG									●		0.18	6.35	2.38
		CCET0602018LKHG									●		0.18	6.35	2.38
		CCET060202RKHG									●		0.2	6.35	2.38
		CCET060202LKHG									●		0.2	6.35	2.38
		CCET09T3005RKHG						●	●				0.05	9.525	3.97
		CCET09T3005LKHG							●				0.05	9.525	3.97
		CCET09T3008RKHG						●	●				0.08	9.525	3.97
		CCET09T3008LKHG							●				0.08	9.525	3.97
		CCET09T3018RKHG						●	●				0.18	9.525	3.97
		CCET09T3018LKHG							●				0.18	9.525	3.97
		CCET09T302RKHG						●	●				0.2	9.525	3.97
CCET09T302LKHG							●				0.2	9.525	3.97		
Internal Middle Cut		F1 CCGT060201FRF1	●				●	●				0.1	6.35	2.38	
		CCGT060202FRF1	●				●	●				0.2	6.35	2.38	
		CCGT060204FRF1	●				●	●				0.4	6.35	2.38	
		CCGT09T302FRF1	●				●	●				0.2	9.525	3.97	
		CCGT09T304FRF1	●				●	●				0.4	9.525	3.97	

● : Line up

Insert POSITIVE TYPE

- : Continuous cutting
- ◐ : Light interrupted cutting
- ◑ : Heavy interrupted cutting

CC

Rhombic, 80°
with hole
Positive 7°

P Steel
M Stainless
N Non-ferrous
S Superalloy
H Hard material

Material	650	ST4	DM4	DT4	QM3	TM4	VM1	ZM3
Steel (P)	●	●	●	●	●	●	●	●
Stainless (M)	●	●	●	●	●	●	●	●
Non-ferrous (N)	●	●	●	●	●	●	●	●
Superalloy (S)	●	●	●	●	●	●	●	●
Hard material (H)	●	●	●	●	●	●	●	●

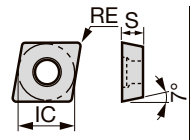

Application	Chipbreaker	Designation	Coated								Dimension (mm)		
			650	ST4	DM4	DT4	QM3	TM4	VM1	ZM3	RE	IC	S
TMV		CCGT09T301MRTMV	●	●			●				0.08	9.525	3.97
		CCGT09T302MRTMV	●	●			●				0.18	9.525	3.97
		CCGT09T304MRTMV	●	●			●				0.38	9.525	3.97
YL		CCGT09T300YL			●		●			0.03	9.525	3.97	
		CCGT09T301MYL	●	●	●	●	●	●		0.08	9.525	3.97	
		CCGT09T302MYL	●	●	●	●	●	●		0.18	9.525	3.97	
		CCGT09T304MYL	●	●	●	●	●	●		0.38	9.525	3.97	
		CCGT09T308MYL	●	●	●	●	●			0.78	9.525	3.97	
U U1		CCGT060200RU			●				●	0.03	6.35	2.38	
		CCGT060201RU			●				●	0.1	6.35	2.38	
		CCGT060201LU							●	0.1	6.35	2.38	
		CCGT060202RU			●				●	0.2	6.35	2.38	
		CCGT060202LU							●	0.2	6.35	2.38	
		CCGT09T300RU1			●		●		●	0.03	9.525	3.97	
		CCGT09T300LU1							●	0.03	9.525	3.97	
		CCGT09T301RU1			●		●		●	0.1	9.525	3.97	
		CCGT09T301LU1							●	0.1	9.525	3.97	
		CCGT09T302RU1			●		●		●	0.2	9.525	3.97	
		CCGT09T302LU1							●	0.2	9.525	3.97	
		CCGT09T304RU1			●		●		●	0.4	9.525	3.97	
CCGT09T304LU1							●	0.4	9.525	3.97			
AM3		CCGT060200FNAM3			●		●	●		0.03	6.35	2.38	
		CCGT060201MFNAM3	●	●	●	●				0.08	6.35	2.38	
		CCGT060202FNAM3							●	0.2	6.35	2.38	
		CCGT060202MFNAM3	●	●	●	●				0.18	6.35	2.38	
		CCGT060204FNAM3							●	0.4	6.35	2.38	
		CCGT060204MFNAM3	●	●	●	●				0.38	6.35	2.38	
		CCGT09T300FNAM3			●		●		●	0.03	9.525	3.97	
		CCGT09T301MFNAM3	●	●	●	●	●	●		0.08	9.525	3.97	
		CCGT09T302FNAM3					●		●	0.2	9.525	3.97	
		CCGT09T302MFNAM3	●	●	●	●	●	●		0.18	9.525	3.97	
		CCGT09T304FNAM3					●		●	0.4	9.525	3.97	
		CCGT09T304MFNAM3	●	●	●	●	●	●		0.38	9.525	3.97	
		CCMT060202FNAM3			●					0.2	6.35	2.38	
		CCMT060204FNAM3			●					0.4	6.35	2.38	
CCMT09T302FNAM3			●					0.2	9.525	3.97			
CCMT09T304FNAM3			●					0.4	9.525	3.97			
CCMT09T308FNAM3			●					0.8	9.525	3.97			

● : Line up

Insert POSITIVE TYPE

- : Continuous cutting
- ◐ : Light interrupted cutting
- ✱ : Heavy interrupted cutting

CC



**Rhombic, 80°
with hole
Positive 7°**

Material	650	ST4	DM4	DT4	QM3	TM4	VM1	ZM3	KM1
P Steel					●	●	●		
M Stainless	●	●	●	●	●	●	●		
N Non-ferrous									●
S Superalloy	●	●	●	●	●	●	●		
H Hard material		●			●				

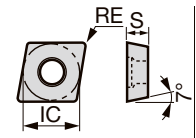

Application	Chipbreaker	Designation	Coated								Uncoated	Dimension (mm)		
			650	ST4	DM4	DT4	QM3	TM4	VM1	ZM3	KM1	RE	IC	S
Middle Cut		CL CCGT060201MCL	●	●	●	●	●					0.08	6.35	2.38
		CCGT060202MCL	●	●	●	●	●					0.18	6.35	2.38
		CCGT09T300CL				●		●				0.03	9.525	3.97
		CCGT09T301MCL	●	●	●	●	●	●				0.08	9.525	3.97
		CCGT09T302MCL	●	●	●	●	●	●				0.18	9.525	3.97
		CCGT09T304MCL	●	●	●	●	●	●				0.38	9.525	3.97
		S CCGT060200RS				●		●	●			0.03	6.35	2.38
		CCGT060200LS						●	●			0.03	6.35	2.38
		CCGT060201MRS				●	●					0.08	6.35	2.38
		CCGT060201RS						●	●			0.1	6.35	2.38
		CCGT060201LS						●	●			0.1	6.35	2.38
		CCGT060202MRS				●	●					0.18	6.35	2.38
		CCGT060202RS						●	●			0.2	6.35	2.38
		CCGT060202LS						●	●			0.2	6.35	2.38
		CCGT060204RS										0.4	6.35	2.38
		CCGT09T300RS				●		●	●	●		0.03	9.525	3.97
		CCGT09T300LS							●			0.03	9.525	3.97
		CCGT09T301MRS				●	●	●				0.08	9.525	3.97
		CCGT09T301RS					●		●	●		0.1	9.525	3.97
		CCGT09T301LS							●	●		0.1	9.525	3.97
CCGT09T302MRS				●	●	●				0.18	9.525	3.97		
CCGT09T302RS					●		●	●		0.2	9.525	3.97		
CCGT09T302LS							●			0.2	9.525	3.97		
CCGT09T304MRS				●	●	●				0.38	9.525	3.97		
CCGT09T304RS					●					0.4	9.525	3.97		
Non-ferrous		V P H CCGW060200FN						●			0.03	6.35	2.38	
		CCGW060200H (M)							●		0.03	6.35	2.38	
		CCGW060201FN							●		0.1	6.35	2.38	
		CCGW060201H (M)								●	0.1	6.35	2.38	
		CCGW060202H (M)								●	0.2	6.35	2.38	
		CCGW09T30V (M)							●		0	9.525	3.97	
		CCGW09T300FN							●		0.03	9.525	3.97	
		CCGW09T300H (M)								●	0.03	9.525	3.97	
		CCGW09T301FN							●		0.1	9.525	3.97	
		CCGW09T301H (M)								●	0.1	9.525	3.97	
		CCGW09T301P (M)							●		0.1	9.525	3.97	
		CCGW09T302H (M)								●	0.2	9.525	3.97	
		CCGW09T302MP				●					0.18	9.525	3.97	
		CCGW09T302P (M)							●		0.2	9.525	3.97	

● : Line up

Reference pages: External toolholder → 3-29 -, Internal toolholder → 4-12 -

Grade
Insert
Ext. Toolholder
Int. Toolholder
Threading
Grooving
Shaper
Endmill
Drilling Tool
Technical Reference

Insert POSITIVE TYPE

- : Continuous cutting
- : Light interrupted cutting
- ✱ : Heavy interrupted cutting

CP



Rhombic, 80°
with hole
Positive 11°

	P	M	N	S	H																			
Steel	●	●	✱	●																				
Stainless	●	●		●																				
Non-ferrous																								
Superalloy																								
Hard material																								

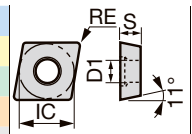

Application	Chipbreaker	Designation	Coated														Coated cermet		Cermet	Uncoated	Dimension (mm)			
			T9215	T9225	T6215	T505	T515	T5115	AH8005	AH8015	AH6225	AH6235	AH905	AH725	AH120	GH730	GT9530	AT9530	NS9530	TH10	RE	IC	S	
Finishing to medium cutting		PS CPMT060202-PS	●	●	●				●	●	●					●	●	●			0.2	6.35	2.38	
		CPMT060204-PS	●	●	●				●	●	●					●	●	●			0.4	6.35	2.38	
		CPMT060208-PS	●	●	●					●	●					●	●	●			0.8	6.35	2.38	
		CPMT080202-PS	●	●	●						●	●				●	●	●			0.2	7.94	2.38	
		CPMT080204-PS	●	●	●							●	●			●	●	●			0.4	7.94	2.38	
		CPMT080208-PS	●	●	●								●	●		●	●	●			0.8	7.94	2.38	
		CPMT090304-PS	●	●	●									●		●	●	●			0.4	9.525	3.18	
		CPMT090308-PS	●	●	●										●	●	●	●	●	●	0.8	9.525	3.18	
		CPMT09T302-PS	●	●	●										●		●	●	●		0.2	9.525	3.97	
		CPMT09T304-PS	●	●	●											●	●	●	●		0.4	9.525	3.97	
		CPMT09T308-PS	●	●	●												●	●	●		0.8	9.525	3.97	
		TM CPMT060202-TM	●	●	●														●			0.2	6.35	2.38
		CPMT060204-TM	●	●	●														●			0.4	6.35	2.38
		CPMT060208-TM	●	●	●														●			0.8	6.35	2.38
		CPMT09T302-TM	●	●	●														●			0.2	9.525	3.97
CPMT09T304-TM	●	●	●														●			0.4	9.525	3.97		
CPMT09T308-TM	●	●	●														●			0.8	9.525	3.97		
All-round CPMT120408																				0.8	12.7	4.76		
Medium cutting		PM CPMT060204-PM			●																0.4	6.35	2.38	
		CPMT060208-PM			●																0.8	6.35	2.38	
		CPMT090304-PM			●														●		0.4	9.525	3.18	
		CPMT090308-PM			●														●		0.8	9.525	3.18	
		24 CPMT080204-24	●																			0.4	7.94	2.38
	CPMT080208-24		●																		0.8	7.94	2.38	
	CPMT090308-24		●																		0.8	9.525	3.18	
	CPMT120408-24																		●		0.8	12.7	4.76	
	CPMT160508-24		●																●		0.8	15.875	5.56	
	CPMT160512-24																		●		1.2	15.875	5.56	

● : Line up

Grade
Insert
Ext. Toolholder
Int. Toolholder
Threading
Grooving
Shaper
Endmill
Drilling Tool
Technical Reference

Insert POSITIVE TYPE

● : Continuous cutting
 ● : Light interrupted cutting
 ✖ : Heavy interrupted cutting

CP



Rhombic, 80°
with hole
Positive 11°

Material	650	ST4	DM4	DT4	QM3	TM4	VM1	ZM3	Others
P Steel						●	●	●	
M Stainless	●	●	●	●	●	●	●	●	
N Non-ferrous						●	●	●	
S Superalloy	●	●	●	●	●	●	●	●	
H Hard material		●		●					

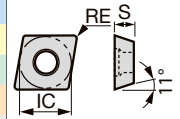

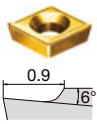
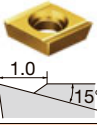
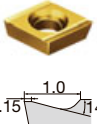
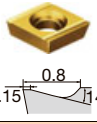
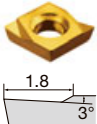
Application	Chipbreaker	Designation	Coated								Dimension (mm)		
			650	ST4	DM4	DT4	QM3	TM4	VM1	ZM3	RE	IC	S
Application	AM5	CPGH060202FNAM5							●	●	0.2	6.35	2.38
		CPGH080202FNAM5							●	●	0.2	7.94	2.38
Light cut	S	CPGH040101LS					●	●			0.1	4.76	1.59
		CPGH040102LS					●	●			0.2	4.76	1.59
		CPGH040104LS					●	●			0.4	4.76	1.59
		CPGH060202LS					●	●			0.2	6.35	2.38
		CPGH060204LS					●	●			0.4	6.35	2.38
	A	CPGH060202FLA						●	●		0.2	6.35	2.38
Light cut		CPGH060204FLA						●	●	0.4	6.35	2.38	
		CPGH080202FLA						●	●	0.2	7.94	2.38	
		CPGH080204FLA						●	●	0.4	7.94	2.38	
		CPGH060202FLA						●	●	0.4	7.94	2.38	
Light cut	A1	CPGH040102FLA1						●	●	0.2	4.76	1.59	
		CPGH040104FLA1						●	●	0.4	4.76	1.59	
Internal middle cut	F1	CPGH040101FRF1	●				●	●		0.1	4.76	1.59	
		CPGH040102FRF1	●				●	●		0.2	4.76	1.59	
		CPGH040104FRF1	●				●	●		0.4	4.76	1.59	
		CPGH060202FRF1	●				●	●		0.2	6.35	2.38	
		CPGH060204FRF1	●				●	●		0.4	6.35	2.38	

● : Line up

Insert POSITIVE TYPE

- : Continuous cutting
- ◐ : Light interrupted cutting
- ✱ : Heavy interrupted cutting

DC

Rhombic, 55°
with hole
Positive 7°



Material	P Steel	M Stainless	N Non-ferrous	S Superalloy	H Hard material	T9215	T9225	AH8005	AH8015	AH905	AH725	SH7025	SH725	SH730	J740	GT9530	J9530	NS9530	Dimension (mm)			
Chipbreaker	●●●●✱	●●	●	●	●															RE	IC	S

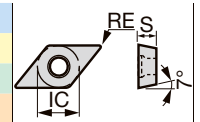

Application	Chipbreaker	Designation	Coated															Coated cemet		Cemet	Dimension (mm)				
			T9215	T9225	AH8005	AH8015	AH905	AH725	SH7025	SH725	SH730	J740	GT9530	J9530	NS9530				RE	IC	S				
Precision finishing (sharp edge)		JP DCGT070200FN-JP									●	●										<0.05	6.35	2.38	
		DCGT070201FN-JP									●	●											<0.1	6.35	2.38
		DCGT070202FN-JP									●	●											<0.2	6.35	2.38
		DCGT11T300FN-JP									●	●											<0.05	9.525	3.97
		DCGT11T301FN-JP									●	●										<0.1	9.525	3.97	
		DCGT11T302FN-JP									●	●											<0.2	9.525	3.97
		01 DCGT070202F-01									●	●											<0.2	6.35	2.38
		DCGT070204F-01									●	●											<0.4	6.35	2.38
	DCGT11T302F-01									●	●										<0.2	9.525	3.97		
	DCGT11T304F-01									●	●											<0.4	9.525	3.97	
	Precision finishing	01 DCGT070202-01														●		●				0.2	6.35	2.38	
		DCGT11T302-01														●						0.2	9.525	3.97	
Finishing (sharp edge)		JS DCGT070200FN-JS									●	●	●								<0.05	6.35	2.38		
		DCGT070201FN-JS									●	●	●									<0.1*	6.35	2.38	
		DCGT070202FN-JS									●	●	●									<0.2*	6.35	2.38	
		DCGT11T300FN-JS									●	●	●									0.03	9.525	3.97	
		DCGT11T301FN-JS									●	●	●									<0.1*	9.525	3.97	
		DCGT11T302FN-JS									●	●	●										<0.2*	9.525	3.97
		DCGT11T304FN-JS									●	●	●										<0.4*	9.525	3.97
		Finishing		JS DCGT070201N-JS									●										0.1	6.35	2.38
DCGT070202N-JS											●											0.2	6.35	2.38	
DCGT11T301N-JS											●											0.1	9.525	3.97	
DCGT11T302N-JS											●											0.2	9.525	3.97	
	DCGT11T304N-JS										●											0.4	9.525	3.97	
	PSF DCMT070202-PSF											●					●		●			0.2	6.35	2.38	
	DCMT070204-PSF	●	●							●						●		●			0.4	6.35	2.38		
	DCMT11T302-PSF									●							●		●			0.2	9.525	3.97	
	DCMT11T304-PSF	●	●	●	●	●	●	●	●							●		●			0.4	9.525	3.97		
	DCMT11T308-PSF	●	●	●	●	●	●	●	●												0.8	9.525	3.97		

*Corner radius (RE) with a sign of inequality (<) means minus tolerance.

● : Line up

● : Continuous cutting
 ● : Light interrupted cutting
 ✱ : Heavy interrupted cutting

Insert POSITIVE TYPE

DC

Rhombic, 55°
 with hole
 Positive 7°



	P	M	N	S	H	Coated	Coated cermet	Cermet	Uncoated				
Steel	●●	●●				●●	●●	●●	●●	●●	●●	●●	●●
Stainless	●●	●●				●●	●●	●●	●●	●●	●●	●●	●●
Non-ferrous						●●	●●	●●	●●	●●	●●	●●	●●
Superalloy						●●	●●	●●	●●	●●	●●	●●	●●
Hard material													

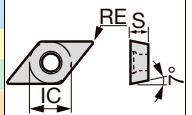

Application	Chipbreaker	Designation	Coated									Coated cermet	Cermet	Uncoated	Dimension (mm)					
			T9215	T9225	T6215	AH8015	AH6225	SH7025	SH725	J740	GH730	GH330	GT9530	J9530	NS9530	TH10	RE	IC	S	
Finishing		PF DCMT070202-PF									●	●	●			0.2	6.35	2.38		
		DCMT070204-PF				●					●	●	●			0.4	6.35	2.38		
		DCMT070208-PF				●						●	●	●			0.8	6.35	2.38	
		DCMT11T302-PF										●	●	●			0.2	9.525	3.97	
		DCMT11T304-PF										●	●	●			0.4	9.525	3.97	
		DCMT11T308-PF											●	●	●			0.8	9.525	3.97
		TSF DCMT070202-TSF	●●	●●	●●	●●	●●							●				0.2	6.35	2.38
DCMT070204-TSF	●●	●●	●●	●●	●●							●				0.4	6.35	2.38		
DCMT070208-TSF	●●	●●	●●	●●	●●							●				0.8	6.35	2.38		
DCMT11T302-TSF	●●	●●	●●	●●	●●							●				0.2	9.525	3.97		
DCMT11T304-TSF	●●	●●	●●	●●	●●							●				0.4	9.525	3.97		
DCMT11T308-TSF	●●	●●	●●	●●	●●							●				0.8	9.525	3.97		
Finishing (sharp edge)		J10 DCGT070200FR-J10					●●	●●							●		0.03	6.35	2.38	
		DCGT070200FL-J10							●●						●		0.03	6.35	2.38	
		DCGT070201FR-J10					●●	●●							●	●		0.1	6.35	2.38
		DCGT070201FL-J10							●●						●	●		0.1	6.35	2.38
		DCGT070202FR-J10					●●	●●							●	●		0.2	6.35	2.38
		DCGT070202FL-J10							●●						●	●		0.2	6.35	2.38
		DCGT070204FR-J10					●●	●●										0.4	6.35	2.38
		DCGT070204FL-J10							●●									0.4	6.35	2.38
		DCGT11T300FR-J10					●●	●●							●			0.03	9.525	3.97
		DCGT11T300FL-J10							●●						●			0.03	9.525	3.97
		DCGT11T301FR-J10					●●	●●						●	●			0.1	9.525	3.97
		DCGT11T301FL-J10							●●					●	●			0.1	9.525	3.97
		DCGT11T302FR-J10					●●	●●						●	●			0.2	9.525	3.97
		DCGT11T302FL-J10							●●					●	●			0.2	9.525	3.97
Finishing		J10 DCGT070202R-J10										●				0.2	6.35	2.38		
		DCGT11T302R-J10											●				0.2	9.525	3.97	
		W10 DCGT070200R-W10													●			0.03	6.35	2.38
		DCGT070200L-W10													●			0.03	6.35	2.38
		DCGT070202R-W10												●	●			0.2	6.35	2.38
		DCGT070202L-W10											●	●				0.2	6.35	2.38
		DCGT070204R-W10										●	●	●				0.4	6.35	2.38
DCGT070204L-W10										●	●	●	●			0.4	6.35	2.38		
Finishing		W15 DCGT11T302R-W15											●	●			0.2	9.525	3.97	
		DCGT11T302L-W15										●	●				0.2	9.525	3.97	
		DCGT11T304R-W15											●	●	●			0.4	9.525	3.97
		DCGT11T304L-W15									●	●	●	●				0.4	9.525	3.97
		DCGT11T308R-W15												●	●	●		0.8	9.525	3.97
		DCGT11T308L-W15												●	●	●		0.8	9.525	3.97

● : Line up

Reference pages: External toolholder → 3-37 -, Internal toolholder → 4-15 -

Insert POSITIVE TYPE

- : Continuous cutting
- ◐ : Light interrupted cutting
- ◑ : Heavy interrupted cutting

DC

Rhombic, 55°
with hole
Positive 7°



Material	Coated	SH725	SH730	SH740	SH750	SH760	SH770	SH780	SH790	SH800	SH810	SH820	SH830	SH840	SH850	SH860	SH870	SH880	SH890	SH900	
P Steel	●●●	●	●	●	●	●	●	●	●	●	●	●	●	●	●	●	●	●	●	●	●
M Stainless	●●●	●	●	●	●	●	●	●	●	●	●	●	●	●	●	●	●	●	●	●	●
N Non-ferrous	●●●	●	●	●	●	●	●	●	●	●	●	●	●	●	●	●	●	●	●	●	●
S Superalloy	●●●	●	●	●	●	●	●	●	●	●	●	●	●	●	●	●	●	●	●	●	●
H Hard material	●●●	●	●	●	●	●	●	●	●	●	●	●	●	●	●	●	●	●	●	●	●

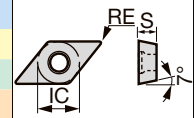

Application	Chipbreaker	Designation	Coated		Dimension (mm)					
			SH725	SH730	RE	IC	S			
Application		JPP DCET0702008MFR-JPP	●	●		<0.08*	6.35	2.38		
		DCET070201MFR-JPP	●	●		<0.1*	6.35	2.38		
		DCET070201MFL-JPP	●	●		<0.1*	6.35	2.38		
		DCET070202MFR-JPP	●	●		<0.2*	6.35	2.38		
		DCET070202MFL-JPP	●	●		<0.2*	6.35	2.38		
		DCET11T3008MFR-JPP	●	●		<0.08*	9.525	3.97		
		DCET11T301MFR-JPP	●	●		<0.1*	9.525	3.97		
		DCET11T301MFL-JPP	●	●		<0.1*	9.525	3.97		
		DCET11T3018MFR-JPP	●	●		<0.18*	9.525	3.97		
		DCET11T3018MFL-JPP	●	●		<0.18*	9.525	3.97		
		DCET11T302MFR-JPP	●	●		<0.2*	9.525	3.97		
		DCET11T302MFL-JPP	●	●		<0.2*	9.525	3.97		
		Finishing (sharp edge)		JRP DCET0702008MFR-JRP	●	●		<0.08*	6.35	2.38
				DCET070201MFR-JRP	●	●		<0.1*	6.35	2.38
DCET070201MFL-JRP	●			●		<0.1*	6.35	2.38		
DCET0702018MFR-JRP	●			●		<0.18*	6.35	2.38		
DCET0702018MFL-JRP	●			●		<0.18*	6.35	2.38		
DCET070202MFR-JRP	●			●		<0.2*	6.35	2.38		
DCET070202MFL-JRP	●			●		<0.2*	6.35	2.38		
DCET11T3008MFR-JRP	●			●		<0.08*	9.525	3.97		
DCET11T301MFR-JRP	●			●		<0.1*	9.525	3.97		
DCET11T3018MFR-JRP	●			●		<0.18*	9.525	3.97		
DCET11T3018MFL-JRP	●			●		<0.18*	9.525	3.97		
DCET11T302MFR-JRP	●			●		<0.2*	9.525	3.97		
DCET11T302MFL-JRP	●			●		<0.2*	9.525	3.97		
Application				JSP DCET0702008MFN-JSP	●	●		<0.08*	6.35	2.38
		DCET070201MFN-JSP	●	●		<0.1*	6.35	2.38		
		DCET070202MFN-JSP	●	●		<0.2*	6.35	2.38		
		DCET11T3008MFN-JSP	●	●		<0.08*	9.525	3.97		
		DCET11T301MFN-JSP	●	●		<0.1*	9.525	3.97		
		DCET11T3018MFN-JSP	●	●		<0.18*	9.525	3.97		
		DCET11T302MFN-JSP	●	●		<0.2*	9.525	3.97		

*Corner radius (RE) with a sign of inequality (<) means minus tolerance.

● : Line up

Insert POSITIVE TYPE

- : Continuous cutting
- ◐ : Light interrupted cutting
- ✱ : Heavy interrupted cutting

DC



Rhombic, 55°
with hole
Positive 7°

P	Steel	●	◐	✱	●	◐	✱	●	◐	✱	●	◐	✱	●	◐	✱	●	◐	✱	●	◐	✱	●	◐	✱	●	◐	✱	●	◐	✱	●	◐	✱	●	◐	✱	●	◐	✱	
M	Stainless	●	◐		●	◐		●	◐		●	◐		●	◐		●	◐		●	◐		●	◐		●	◐		●	◐		●	◐		●	◐		●	◐		
N	Non-ferrous																																								
S	Superalloy																																								
H	Hard material																																								

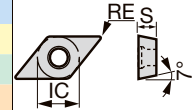

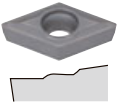
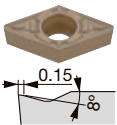
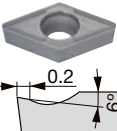
Application	Chipbreaker	Designation	Coated							Coated cermet	Cermet	Dimension (mm)				
			T9215	T9225	T6215	AH6225	AH6235	AH725	AH120	GH730	GT9530	NS9530	RE	IC	S	
Finishing to medium cutting		DCMT070204-23									●		0.4	6.35	2.38	
		DCMT11T304-23									●		0.4	9.525	3.97	
		DCMT11T308-23									●		0.8	9.525	3.97	
Medium cutting	 <small>0.15 6°</small>	PM DCMT070204-PM	●	●	●	●	●	●	●	●	●		0.4	6.35	2.38	
		DCMT070208-PM	●	●	●	●	●	●	●	●	●		0.8	6.35	2.38	
		DCMT11T304-PM	●	●	●	●	●	●	●	●	●		0.4	9.525	3.97	
		DCMT11T308-PM	●	●	●	●	●	●	●	●	●		0.8	9.525	3.97	
		DCMT11T312-PM		●	●	●	●	●					1.2	9.525	3.97	
	 <small>0.2 6°</small>	24 DCMT070202-24										●		0.2	6.35	2.38
		DCMT070204-24	●	●								●		0.4	6.35	2.38
DCMT070208-24			●								●		0.8	6.35	2.38	
	DCMT11T302-24		●								●		0.2	9.525	3.97	
	DCMT11T304-24	●	●								●		0.4	9.525	3.97	
	DCMT11T308-24	●	●	●							●		0.8	9.525	3.97	

● : Line up

1 Grade

2 Insert

3 Ext. Toolholder

4 Int. Toolholder

5 Threading

6 Grooving

7 Shaper

8 Endmill

9 Drilling Tool

10 Technical Reference

Positive
Negative
CBN
PCD
C
D
E
F
G
T
V
W
Y
OTHERS

Insert POSITIVE TYPE

- : Continuous cutting
- ◐ : Light interrupted cutting
- ◑ : Heavy interrupted cutting

DC



Rhombic, 55°
with hole
Positive 7°

	P	M	N	S	H																						
Steel										●	●	●	●	●	●	●											
Stainless							●	●	●																		
Non-ferrous																											
Superalloy							●			●																	
Hard material																											

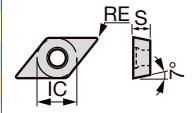

Application	Chipbreaker	Designation	Coated											Dimension (mm)									
			650	ST4	DM4	DT4	QM3	TM4	VM1	ZM3							RE	IC	S				
Light cut	1.1 R	UHG DCET0702008RUHG																●	0.08	6.35	2.38		
		DCET11T3008RUHG																	●	0.08	9.525	3.97	
	U-WP U1-WP DCGT0702005RU-WP					●												●	0.05	6.35	2.38		
	DCGT0702015RU-WP																		●	0.15	6.35	2.38	
	DCGT11T3005RU1-WP																		●	0.05	9.525	3.97	
	DCGT11T3015RU1-WP																		●	0.15	9.525	3.97	
Middle Cut	4.8 17	CL DCGT070201MCL	●	●	●	●	●												0.08	6.35	2.38		
		DCGT070202MCL	●	●	●	●	●													0.18	6.35	2.38	
		DCGT070204MCL	●	●	●	●	●													0.38	6.35	2.38	
		DCGT11T301MCL	●	●	●	●	●	●												0.08	9.525	3.97	
		DCGT11T302MCL	●	●	●	●	●	●												0.18	9.525	3.97	
		DCGT11T304MCL	●	●	●	●	●	●												0.38	9.525	3.97	
	1.0 15°	S DCGT070200RS				●														0.03	6.35	2.38	
		DCGT070200LS																		●	0.03	6.35	2.38
		DCGT070201MRS				●	●														0.08	6.35	2.38
		DCGT070201RS																		●	0.1	6.35	2.38
		DCGT070201LS																		●	0.1	6.35	2.38
DCGT070202MRS					●	●														0.18	6.35	2.38	
DCGT070202RS																			●	0.2	6.35	2.38	
DCGT070202LS																			●	0.2	6.35	2.38	
DCGT070204RS																			●	0.4	6.35	2.38	
DCGT11T300RS					●							●	●							0.03	9.525	3.97	
DCGT11T300LS																			●	0.03	9.525	3.97	
DCGT11T301MRS					●	●	●													0.08	9.525	3.97	
DCGT11T301RS																			●	0.1	9.525	3.97	
DCGT11T301LS																			●	0.1	9.525	3.97	
DCGT11T302MRS					●	●	●													0.18	9.525	3.97	
DCGT11T302RS																		●	0.2	9.525	3.97		
DCGT11T302LS																		●	0.2	9.525	3.97		
DCGT11T304MRS				●	●	●													0.38	9.525	3.97		
DCGT11T304RS																		●	0.4	9.525	3.97		

● : Line up

Insert POSITIVE TYPE

- : Continuous cutting
- ◐ : Light interrupted cutting
- ◑ : Heavy interrupted cutting





DC

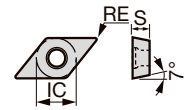

**Rhombic, 55°
with hole
Positive 7°**

Material	P	Steel					●	◐	◐	◐												
	M	Stainless		◐	◐	◐	◐			◐												
	N	Non-ferrous								◐												
	S	Superalloy		◐	◐	◐	◐															
H	Hard material			◐	◐	◐																



Application	Chipbreaker	Designation	Coated									Uncoated	Dimension (mm)				
			650	ST4	DM4	DT4	QM3	TM4	VM1	ZM3		KM1	RE	IC	S		
Middle Cut	AM3-WP 	DCGT11T3005AM3-WP	●	●	●	●							0.05	9.525	3.97		
		DCGT11T3015AM3-WP	●	●	●	●							0.15	9.525	3.97		
	S-WP 	DCGT0702005RS-WP					●		●	●			0.05	6.35	2.38		
		DCGT0702005LS-WP								●			0.05	6.35	2.38		
		DCGT0702015RS-WP					●			●			0.15	6.35	2.38		
		DCGT0702015LS-WP								●			0.15	6.35	2.38		
		DCGT11T3005RS-WP					●		●	●			0.05	9.525	3.97		
		DCGT11T3015RS-WP					●			●			0.15	9.525	3.97		
Non-ferrous	V P H 	DCGW07020V									●		0	6.35	2.38		
		DCGW070200FN										●		0.03	6.35	2.38	
		DCGW070200H										●		0.03	6.35	2.38	
		DCGW070201FN											●		0.1	6.35	2.38
		DCGW070201H											●		0.1	6.35	2.38
		DCGW070202H											●		0.2	6.35	2.38
		DCGW11T30V									●			0	9.525	3.97	
		DCGW11T300FN										●		0.03	9.525	3.97	
		DCGW11T300H										●		0.03	9.525	3.97	
		DCGW11T301FN											●		0.1	9.525	3.97
		DCGW11T301H											●		0.1	9.525	3.97
		DCGW11T302H											●		0.2	9.525	3.97
H 	DCGW0702005RH-WP												0.05	6.35	2.38		
	DCGW11T3005RH-WP												0.05	9.525	3.97		

● : Line up

Features of DC.T-WP insert

NTK WP style inserts have a wiper facet design. The insert has a 0.3mm flat on the cutting edge when the insert is set into the toolholder. The flat on the cutting edge ensures a superior surface when feed rates are increased. WP style inserts can be used in toolholders: SDJC, CH-SDUL and DS-SDUL.

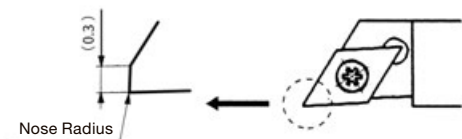

Reference pages: External toolholder → 3-37 -, Internal toolholder → 4-15 -



Insert POSITIVE TYPE / DOUBLE SIDE

- : Continuous cutting
- ◐ : Light interrupted cutting
- ✳ : Heavy interrupted cutting

DXRhombic, 55°
with hole

	P	M	N	S	H																																			
Steel	●	◐	◐	◐	◐																																			
Stainless	●	●																																						
Non-ferrous			◐	◐	◐																																			
Superalloy				◐	◐																																			
Hard material																																								

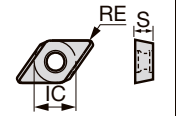

Application	Chipbreaker	Designation	Coated			Coated cermet	Cermet	Uncoated	Dimension (mm)		
			T9215 T9225	AH8015 AH725	SH725	GT9530	NS9530	KS05F	RE	IC	S
Finishing (sharp edge)		JRP DXGU070301MFRE-JRP*			●				<0.1*	6.35	3.18
		DXGU070301MFLE-JRP*			●				<0.1*	6.35	3.18
		DXGU070302MFRE-JRP*			●				<0.2*	6.35	3.18
		DXGU070302MFLE-JRP*			●				<0.2*	6.35	3.18
Finishing		JSS DXGU070301MFR-JSS			●				<0.1*	6.35	3.18
		DXGU070301MFL-JSS			●				<0.1*	6.35	3.18
		DXGU070302MFR-JSS			●				<0.2*	6.35	3.18
		DXGU070302MFL-JSS			●				<0.2*	6.35	3.18
Finishing		JSS DXGU070301MR-JSS		●					<0.1*	6.35	3.18
		DXGU070301ML-JSS		●					<0.1*	6.35	3.18
		DXGU070302MR-JSS		●					<0.2*	6.35	3.18
		DXGU070302ML-JSS		●					<0.2*	6.35	3.18
Finishing		SS DXGU070302R-SS	●	●		●		●	0.2	6.35	3.18
		DXGU070302L-SS	●	●		●		●	0.2	6.35	3.18
		DXGU070304R-SS	●	●		●		●	0.4	6.35	3.18
		DXGU070304L-SS	●	●		●		●	0.4	6.35	3.18
Finishing to medium cutting (sharp edge)		JS DXGU070301MFR-JS ⁽¹⁾			●				<0.1*	6.35	3.18
		DXGU070301MFL-JS ⁽¹⁾			●				<0.1*	6.35	3.18
		DXGU070302MFR-JS ⁽¹⁾			●				<0.2*	6.35	3.18
		DXGU070302MFL-JS ⁽¹⁾			●				<0.2*	6.35	3.18
		DXGU070304MFR-JS ⁽¹⁾			●				<0.4*	6.35	3.18
		DXGU070304MFL-JS ⁽¹⁾			●				<0.4*	6.35	3.18
Finishing to medium cutting		JTS DXGU070301MFR-JTS			●				<0.1*	6.35	3.18
		DXGU070301MFL-JTS			●				<0.1*	6.35	3.18
		DXGU070302MFR-JTS			●				<0.2*	6.35	3.18
		DXGU070302MFL-JTS			●				<0.2*	6.35	3.18
Finishing to medium cutting		JTS DXGU070301MR-JTS		●					<0.1*	6.35	3.18
		DXGU070301ML-JTS		●					<0.1*	6.35	3.18
		DXGU070302MR-JTS		●					<0.2*	6.35	3.18
		DXGU070302ML-JTS		●					<0.2*	6.35	3.18

* Corner radius (RE) with a sign of inequality (<) means minus tolerance.

● : Line up

(1) Due to chipbreaker profile, max ap for face or ID turning is 1 mm

Insert POSITIVE TYPE

- : Continuous cutting
- ◐ : Light interrupted cutting
- ◑ : Heavy interrupted cutting

DX



**Rhombic, 55°
with hole**

	P Steel	M Stainless	N Non-ferrous	S Superalloy	H Hard material														
	◐◑	◑	◐	◑	◑		◐◑			◐◑									



Application	Chipbreaker	Designation	Coated						Coated cermet	Cermet	Uncoated	Dimension (mm)		
			T9215	T9225	AH8015	AH725	SH725	GT9530	NS9530	KS05F	RE	IC	S	
Finishing to medium cutting		TS DXGU070302R-TS			●	●		●	●	●		0.2	6.35	3.18
		DXGU070302L-TS			●	●		●	●	●		0.2	6.35	3.18
		DXGU070304R-TS			●	●		●	●	●		0.4	6.35	3.18
		DXGU070304L-TS			●	●		●	●	●		0.4	6.35	3.18
		DXGU070308R-TS			●	●		●	●	●		0.8	6.35	3.18
		DXGU070308L-TS			●	●		●	●	●		0.8	6.35	3.18
Finishing to medium cutting		TS DXMU070302R-TS	●	●	●	●						0.2	6.35	3.18
		DXMU070302L-TS	●	●	●	●						0.2	6.35	3.18
		DXMU070304R-TS	●	●	●	●						0.4	6.35	3.18
		DXMU070304L-TS	●	●	●	●						0.4	6.35	3.18
		DXMU070308R-TS	●	●	●	●						0.8	6.35	3.18
		DXMU070308L-TS	●	●	●	●						0.8	6.35	3.18

* Corner radius (RE) with a sign of inequality (<) means minus tolerance.
 (1) Due to chipbreaker profile, max ap for face or ID turning is 1 mm

● : Line up

- Grade 1
- Insert 2
- Ext. Toolholder 3
- Int. Toolholder 4
- Threading 5
- Grooving 6
- Shaper 7
- Endmill 8
- Drilling Tool 9
- Technical Reference 10

Insert POSITIVE TYPE

● : Continuous cutting
 ● : Light interrupted cutting
 ✱ : Heavy interrupted cutting

EP

Rhombic, 75°
with hole
Positive 11°

	P	M	N	S	H	Coated	SH7025	SH725	SH730	J740
Steel	●●●●●									
Stainless	●●●●●									
Non-ferrous										
Superalloy					●●					
Hard material										

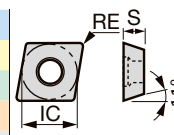

Application	Chipbreaker	Designation	Coated				Dimension (mm)		
			SH7025	SH725	SH730	J740	RE	IC	S
Finishing (sharp edge)		JS EPGT03X101F-JS	●●				<0.1	3.57	1.39
		EPGT03X102F-JS	●●				<0.2	3.57	1.39
		EPGT03X104F-JS	●●				<0.4	3.57	1.39
		EPGT040101F-JS	●●				<0.1	3.97	1.59
		EPGT040102F-JS	●●				<0.2	3.97	1.59
		EPGT040104F-JS	●●				<0.4	3.97	1.59
Finishing		JS EPGT03X101-JS		●			<0.1	3.57	1.39
		EPGT03X102-JS		●			<0.2	3.57	1.39
		EPGT03X104-JS		●			<0.4	3.57	1.39
		EPGT040101-JS		●			<0.1	3.97	1.59
		EPGT040102-JS		●			<0.2	3.97	1.59
		EPGT040104-JS		●			<0.4	3.97	1.59
Finishing (sharp edge)		J08 EPGT040100FL-J08		●			0.03	3.97	1.59
		EPGT040102FL-J08	●●				0.2	3.97	1.59
		EPGT040104FL-J08	●●				0.4	3.97	1.59
Finishing		J08 EPGT040100L-J08		●●			0.03	3.97	1.59
		EPGT040102L-J08		●●			0.2	3.97	1.59
		EPGT040104L-J08		●●			0.4	3.97	1.59

*Corner radius (RE) with a sign of inequality (<) means minus tolerance.

● : Line up

Insert POSITIVE TYPE

- : Continuous cutting
- ◐ : Light interrupted cutting
- ◑ : Heavy interrupted cutting

EP



**Rhombic, 75°
with hole
Positive 11°**

Material	Steel	Stainless	Non-ferrous	Superalloy	Hard material	Coated	Coated cermet	Cermet	Uncoated
P	●	◐	◐	◐	◐	●	◐	◐	●
M	●	◐	◐	◐	◐	●	◐	◐	●
N	●	◐	◐	◐	◐	●	◐	◐	●
S	●	◐	◐	◐	◐	●	◐	◐	●
H	●	◐	◐	◐	◐	●	◐	◐	●

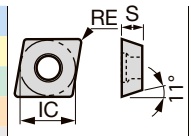

Application	Chipbreaker	Designation	Coated			Coated cermet	Cermet	Uncoated	Dimension (mm)				
			GH110	SH7025	SH725	SH730	GT9530	NS9530	TH10	UX30	RE	IC	S
Finishing (sharp edge)		W08 EPGT03X100FL-W08	●	●							0.03	3.57	1.39
		EPGT03X100FR-W08		●							0.03	3.57	1.39
		EPGT03X101FL-W08	●	●							0.1	3.57	1.39
		EPGT03X101FR-W08		●							0.1	3.57	1.39
		EPGT03X102FL-W08	●	●							0.2	3.57	1.39
		EPGT03X102FR-W08		●							0.2	3.57	1.39
		EPGT03X104FL-W08	●	●							0.4	3.57	1.39
		EPGT03X104FR-W08		●							0.4	3.57	1.39
		EPGT040100FL-W08	●	●							0.03	3.97	1.59
		EPGT040100FR-W08		●							0.03	3.97	1.59
		EPGT040101FL-W08	●	●							0.1	3.97	1.59
		EPGT040101FR-W08		●							0.1	3.97	1.59
		EPGT040102FL-W08	●	●							0.2	3.97	1.59
		EPGT040102FR-W08		●							0.2	3.97	1.59
		EPGT040104FL-W08	●	●							0.4	3.97	1.59
		EPGT040104FR-W08		●							0.4	3.97	1.59
Finishing		W08 EPGT03X100R-W08		●				●			0.03	3.57	1.39
		EPGT03X100L-W08		●				●			0.03	3.57	1.39
		EPGT03X101R-W08		●					●		0.1	3.57	1.39
		EPGT03X101L-W08		●					●		0.1	3.57	1.39
		EPGT03X102R-W08		●					●		0.2	3.57	1.39
		EPGT03X102L-W08		●					●		0.2	3.57	1.39
		EPGT03X104R-W08		●					●		0.4	3.57	1.39
		EPGT03X104L-W08		●					●		0.4	3.57	1.39
		EPGT040100R-W08		●					●		0.03	3.97	1.59
		EPGT040100L-W08	●	●				●	●		0.03	3.97	1.59
		EPGT040101R-W08		●					●		0.1	3.97	1.59
		EPGT040101L-W08		●					●		0.1	3.97	1.59
		EPGT040102R-W08	●	●				●	●		0.2	3.97	1.59
		EPGT040102L-W08	●	●			●	●	●		0.2	3.97	1.59
		EPGT040104R-W08	●	●				●	●		0.4	3.97	1.59
		EPGT040104L-W08	●	●			●	●	●		0.4	3.97	1.59

● : Line up

Insert POSITIVE TYPE

- : Continuous cutting
- ◐ : Light interrupted cutting
- ◑ : Heavy interrupted cutting

TC



Triangular with hole Positive 7°

Material	Coated	Coated cermet	Cermet	Uncoated
P Steel	◐◐◐◐◐◐	◐◐	◐◐	●
M Stainless	◐◐◐◐◐◐			●
N Non-ferrous				●
S Superalloy				
H Hard material				

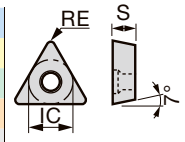

Application	Chipbreaker	Designation	Coated			Coated cermet	Cermet	Uncoated	Dimension (mm)		
			SH7025	SH725	J740	J9530	NS9530	TH10	RE	IC	S
Finishing (sharp edge)		J08 TCGT080200FR-J08	●	●	●			●	0.03	4.76	2.38
		TCGT080200FL-J08	●	●			●	0.03	4.76	2.38	
		TCGT080201FR-J08	●	●	●			●	0.1	4.76	2.38
		TCGT080201FL-J08	●	●			●	0.1	4.76	2.38	
		TCGT080202FR-J08	●	●	●			●	0.2	4.76	2.38
		TCGT080202FL-J08	●	●	●			●	0.2	4.76	2.38
		TCGT080204FR-J08	●	●					0.4	4.76	2.38
		J10 TCGT110200FR-J10	●	●	●			●	0.03	6.35	2.38
		TCGT110200FL-J10	●	●			●	0.03	6.35	2.38	
		TCGT110201FR-J10	●	●	●			●	0.1	6.35	2.38
		TCGT110201FL-J10	●	●			●	0.1	6.35	2.38	
		TCGT110202FR-J10	●	●	●		●	●	0.2	6.35	2.38
		TCGT110202FL-J10	●	●	●		●	●	0.2	6.35	2.38
		TCGT110204FR-J10	●	●					0.4	6.35	2.38
J10 TCGT110300FR-J10		●	●	●			●	0.03	6.35	3.18	
TCGT110300FL-J10		●	●			●	●	0.03	6.35	3.18	
TCGT110301FR-J10		●	●	●			●	0.1	6.35	3.18	
TCGT110301FL-J10	●	●			●	●	0.1	6.35	3.18		
TCGT110302FR-J10	●	●	●		●	●	0.2	6.35	3.18		
TCGT110302FL-J10	●	●	●		●	●	0.2	6.35	3.18		
Finishing		J10 TCGT110302R-J10				●		0.2	6.35	3.18	
		TCGT110302L-J10				●		0.2	6.35	3.18	
		W15 TCGT16T302L-W15						●	0.2	9.525	3.97
		TCGT16T304L-W15					●	●	0.4	9.525	3.97
		TCGT16T308L-W15						●	0.8	9.525	3.97

● : Line up

Reference pages: External toolholder → [3-63](#), Internal toolholder → [4-21](#) -

Grade
Insert
Toolholder
Ext. Toolholder
Int. Toolholder
Threading
Grooving
Shaper
Endmill
Drilling Tool
Technical Reference

Insert POSITIVE TYPE

- : Continuous cutting
- ◐ : Light interrupted cutting
- ◑ : Heavy interrupted cutting

TC



Triangular
with hole
Positive 7°

Material	P Steel	M Stainless	N Non-ferrous	S Superalloy	H Hard material	Coated	Cermet	Uncoated
Coated	●●	●	●	●		●	●	●
Cermet	●	●	●	●		●		●
Uncoated								

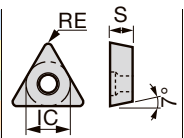

Application	Chipbreaker	Designation	Coated					Cermet	Uncoated	Dimension (mm)			
			T9215	T9225	T6215	AH6225	AH6235	AH725	NS9530	TH10	RE	IC	S
Finishing		SS TCGT110202-SS							●		0.2	6.35	2.38
		TCGT110204-SS							●		0.4	6.35	2.38
		TCGT110208-SS							●		0.8	6.35	2.38
		TCGT16T304-SS							●		0.4	9.525	3.97
Finishing to medium cutting		23 TCMT090204-23	●						●		0.4	5.56	2.38
		TCMT110204-23							●		0.4	6.35	2.38
		TCMT16T304-23							●		0.4	9.525	3.97
		TCMT16T308-23	●								0.8	9.525	3.97
	-	TCGT080102R							●	●	0.2	4.76	1.59
Medium cutting		PM TCMT110202-PM			●	●	●	●			0.2	6.35	2.38
		TCMT110204-PM	●	●	●	●	●	●	●		0.4	6.35	2.38
		TCMT110208-PM	●	●	●	●	●	●	●		0.8	6.35	2.38
		TCMT110302-PM			●	●	●				0.2	6.35	3.18
		TCMT110304-PM			●	●	●				0.4	6.35	3.18
		TCMT110308-PM			●	●	●				0.8	6.35	3.18
		TCMT16T304-PM	●	●	●	●	●	●	●		0.4	9.525	3.97
		TCMT16T308-PM	●	●	●	●	●	●	●		0.8	9.525	3.97
		TCMT16T312-PM	●	●	●	●	●	●			1.2	9.525	3.97
	24 TCMT090202-24								●		0.2	5.56	2.38
	TCMT090204-24	●	●						●		0.4	5.56	2.38
	TCMT110202-24								●		0.2	6.35	2.38
TCMT110204-24	●	●						●		0.4	6.35	2.38	
TCMT110208-24			●							0.8	6.35	2.38	
TCMT16T304-24	●	●						●		0.4	9.525	3.97	
TCMT16T308-24	●	●			●					0.8	9.525	3.97	

● : Line up

Reference pages: External toolholder → **3-63**, Internal toolholder → **4-21** -

Grade
Insert
Ext. Toolholder
Int. Toolholder
Threading
Grooving
Shaper
Endmill
Drilling Tool
Technical Reference

Insert POSITIVE TYPE

- : Continuous cutting
- : Light interrupted cutting
- * : Heavy interrupted cutting

TC



**Rhombic, 60°
with hole
Positive 7°**

P Steel																																						
M Stainless			●●●●	●			●●●●			●																												
N Non-ferrous										●																												
S Superalloy	●●							●●																														
H Hard material																																						

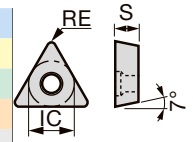

Grade 1
Insert 2
Ext. Toolholder 3
Int. Toolholder 4
Threading 5
Grooving 6
Shaper 7
Endmill 8
Drilling Tool 9
Technical Reference 10

Application	Chipbreaker	Designation	Coated								Dimension (mm)					
			650	ST4	DM4	DT4	QM3	TM4	VM1	ZM3	RE	IC	S			
Middle Cut 	S	TCGT090201RS											0.1	5.56	2.38	
		TCGT090201LS											0.1	5.56	2.38	
	TCGT090202RS												0.2	5.56	2.38	
	TCGT110201RS												0.1	6.35	2.38	
	TCGT110201LS												0.1	6.35	2.38	
	S-WP	TCGT0902005RS-WP												0.05	5.56	2.38
		TCGT0902005LS-WP												0.05	5.56	2.38
		TCGT0902015RS-WP												0.15	5.56	2.38
		TCGT0902015LS-WP												0.15	5.56	2.38
		TCGT1102005RS-WP												0.05	6.35	2.38
		TCGT1102015RS-WP												0.15	6.35	2.38
Non-ferrous		TCGW090200FN											0.03	5.56	2.38	
		TCGW090201FN												0.1	5.56	2.38
		TCGW110200FN												0.03	6.35	2.38
		TCGW110201FN												0.1	6.35	2.38

● : Line up

Features of TCGT-WP insert

NTK WP style inserts have a wiper facet design. The insert has a 0.3mm flat on the cutting edge when the insert is set into the toolholder. The flat on the cutting edge ensures a superior surface when feed rates are increased. WP style inserts can be used in toolholders: STAC

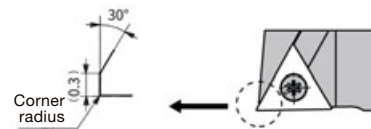

Reference pages: External toolholder → 3-63, Internal toolholder → 4-21 -

Insert POSITIVE TYPE

- : Continuous cutting
- ◐ : Light interrupted cutting
- ◑ : Heavy interrupted cutting

TP



Triangular with hole Positive 11°

	P	M	N	S	H	Coated	Coated cermet	Cermet	Dimension (mm)
Steel	●	◐	◐	◐	◐	●	●	●	RE, IC, S
Stainless	◐	◐	◐	◐	◐	●	●	●	RE, IC, S
Non-ferrous	◐	◐	◐	◐	◐	●	●	●	RE, IC, S
Superalloy	◐	◐	◐	◐	◐	●	●	●	RE, IC, S
Hard material	◐	◐	◐	◐	◐	●	●	●	RE, IC, S

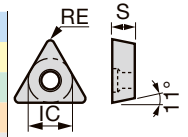

Application	Chipbreaker	Designation	Coated							Coated cermet		Cermet	Dimension (mm)				
			T9215	T9225	T6215	AH8005	AH8015	AH6225	AH6235	AH725	AH120	GH730	GT9530	AT9530	NS9530	RE	IC
Finishing to medium cutting		PSS TPMT090204-PSS	●	●	●			●	●	●			●		0.4	5.56	2.38
		TPMT090208-PSS	●	●	●			●	●	●			●		0.8	5.56	2.38
		TPMT110204-PSS	●	●	●			●	●	●			●		0.4	6.35	2.38
		TPMT110208-PSS	●	●	●			●	●	●			●		0.8	6.35	2.38
		TPMT110304-PSS	●	●	●			●	●	●					0.4	6.35	3.18
		TPMT110308-PSS	●	●	●			●	●	●					0.8	6.35	3.18
		TPMT130304-PSS	●	●	●			●	●	●					0.4	7.94	3.18
		TPMT130308-PSS	●	●	●			●	●	●			●		0.8	7.94	3.18
		TPMT16T304-PSS	●	●	●			●	●	●			●		0.4	9.525	3.97
	TPMT16T308-PSS	●	●	●			●	●	●			●		0.8	9.525	3.97	
		PS TPMT090202-PS	●	●	●			●	●	●			●		0.2	5.56	2.38
		TPMT090204-PS	●	●	●			●	●	●			●		0.4	5.56	2.38
		TPMT090208-PS	●	●	●			●	●	●			●		0.8	5.56	2.38
		TPMT110202-PS	●	●	●			●	●	●			●		0.2	6.35	2.38
		TPMT110204-PS	●	●	●			●	●	●			●		0.4	6.35	2.38
		TPMT110208-PS	●	●	●			●	●	●			●		0.8	6.35	2.38
		TPMT110302-PS	●	●	●		●						●		0.2	6.35	3.18
		TPMT110304-PS	●	●	●		●	●	●	●			●		0.4	6.35	3.18
TPMT110308-PS		●	●	●		●	●	●	●			●		0.8	6.35	3.18	
TPMT130302-PS		●	●					●				●		0.2	7.94	3.18	
TPMT130304-PS	●	●	●				●	●			●		0.4	7.94	3.18		
TPMT130308-PS	●	●	●				●	●			●		0.8	7.94	3.18		
TPMT16T304-PS	●	●	●				●	●			●		0.4	9.525	3.97		
TPMT16T308-PS	●	●	●				●	●			●		0.8	9.525	3.97		
	TM TPMT110204-TM	●	●										0.4	6.35	2.38		
	TPMT110208-TM	●	●										0.8	6.35	2.38		
	TPMT110302-TM	●	●	●		●	●					●	0.2	6.35	3.18		
	TPMT110304-TM	●	●	●		●	●					●	0.4	6.35	3.18		
	TPMT110308-TM	●	●	●		●	●					●	0.8	6.35	3.18		
	TPMT16T304-TM	●	●										0.4	9.525	3.97		
TPMT16T308-TM	●	●										0.8	9.525	3.97			
	H11 TPGH110302L-H11											●	0.2	6.35	3.18		
	TPGH110304L-H11											●	0.4	6.35	3.18		
	23 TPMT090202-23											●	0.2	5.56	2.38		
	TPMT090204-23		●									●	0.4	5.56	2.38		
	TPMT110204-23		●									●	0.4	6.35	2.38		
	TPMT130304-23		●									●	0.4	7.94	3.18		
	TPMT130308-23		●									●	0.8	7.94	3.18		
	TPMT16T304-23											●	0.4	9.525	3.97		
TPMT16T308-23		●									●	0.8	9.525	3.97			

● : Line up

Reference pages: Internal toolholder → 4-22 -

Grade
Insert
Toolholder
Ext. Toolholder
Int. Toolholder
Threading
Grooving
Shaper
Endmill
Drilling Tool
Technical Reference

TP



Rhombic, 60° with hole Positive 11°

P Steel							●	●	●	●												
M Stainless	●	●	●				●		●	●												
N Non-ferrous																						
S Superalloy	●	●	●	●	●				●													
H Hard material		●	●		●	●																

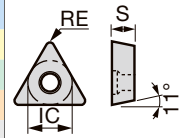

Application	Chipbreaker	Designation	Coated								Dimension (mm)					
			650	ST4	DM4	DT4	QM3	TM4	VM1	ZM3	RE	IC	S			
Internal finishing		FG TPGH090202RFG		●			●	●					0.2	5.56	2.38	
		TPGH090204RFG		●			●	●					0.4	5.56	2.38	
		TPGH110302RFG		●			●	●						0.2	6.35	3.18
		TPGH110304RFG		●			●	●						0.4	6.35	3.18
		K TPGH090202FLK							●				0.2	5.56	2.38	
	TPGH090204FLK							●				0.4	5.56	2.38		
	TPGH090208FLK							●				0.8	5.56	2.38		
Internal middle cut		F1 TPGH080202FRF1						●	●	●			0.2	4.76	2.38	
		TPGH080204FRF1						●	●	●			0.4	4.76	2.38	
		TPGH090201FRF1		●			●	●						0.1	5.56	2.38
		TPGH090202FRF1		●			●	●	●	●				0.2	5.56	2.38
		TPGH090204FRF1		●			●	●	●	●				0.4	5.56	2.38
		TPGH090208FRF1		●			●	●	●	●				0.8	5.56	2.38
		TPGH110302FRF1		●			●	●	●	●				0.2	6.35	3.18
		TPGH110304FRF1		●			●	●	●	●				0.4	6.35	3.18
		TPGH110308FRF1		●			●	●	●	●				0.8	6.35	3.18
		B2 TPGH090202FLB2							●	●			0.2	5.56	2.38	
	TPGH090204FLB2							●	●			0.4	5.56	2.38		
	TPGH090208FLB2							●	●			0.8	5.56	2.38		
	B3 TPGH080202FLB3							●	●			0.2	4.76	2.38		
	TPGH080204FLB3							●	●			0.4	4.76	2.38		

● : Line up

Reference pages: Internal toolholder → 4-22 -

Insert POSITIVE TYPE

- : Continuous cutting
- : Light interrupted cutting
- ✱ : Heavy interrupted cutting

VB

**Rhombic, 35°
with hole
Positive 5°**



Material	Steel	Stainless	Non-ferrous	Superalloy	Hard material	Coated	Coated cermet	Cermet											
P	●	●	●	●	●	●	●	●	●	●	●	●	●	●	●	●	●	●	●
M	●	●	●	●	●	●	●	●	●	●	●	●	●	●	●	●	●	●	●
N	●	●	●	●	●	●	●	●	●	●	●	●	●	●	●	●	●	●	●
S	●	●	●	●	●	●	●	●	●	●	●	●	●	●	●	●	●	●	●
H	●	●	●	●	●	●	●	●	●	●	●	●	●	●	●	●	●	●	●

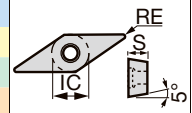

Application	Chipbreaker	Designation	Coated								Coated cermet		Cermet	Dimension (mm)				
			T9215	T9225	T6215	AH8005	AH8015	AH6225	AH6235	AH725	AH120	GT9530	AT9530	NS9530	RE	IC	S	
Finishing to medium cutting		PSS VBMT110304-PSS	●	●	●			●	●	●			●		0.4	6.35	3.18	
		VBMT110308-PSS	●	●	●			●	●	●			●		0.8	6.35	3.18	
		VBMT160404-PSS	●	●	●			●	●	●			●		0.4	9.525	4.76	
		VBMT160408-PSS	●	●	●			●	●	●			●		0.8	9.525	4.76	
		VBMT160412-PSS	●	●						●					1.2	9.525	4.76	
		PS	VBMT110302-PS	●	●	●	●	●	●	●	●			●		0.2	6.35	3.18
Finishing to medium cutting		VBMT110304-PS	●	●	●	●	●	●	●	●			●		0.4	6.35	3.18	
		VBMT110308-PS	●	●	●	●	●	●	●	●	●			●		0.8	6.35	3.18
		VBMT160402-PS	●	●	●	●	●	●	●	●			●		0.2	9.525	4.76	
		VBMT160404-PS	●	●	●	●	●	●	●	●			●		0.4	9.525	4.76	
		VBMT160408-PS	●	●	●	●	●	●	●	●			●		0.8	9.525	4.76	
		Finishing to medium cutting		TM VBMT110302-TM	●	●	●			●				●		0.2	6.35	3.18
VBMT110304-TM	●			●	●			●				●		0.4	6.35	3.18		
VBMT110308-TM	●			●	●			●				●		0.8	6.35	3.18		
VBMT160402-TM	●			●	●			●				●		0.2	9.525	4.76		
VBMT160404-TM	●			●	●			●				●		0.4	9.525	4.76		
VBMT160408-TM	●			●	●			●				●		0.8	9.525	4.76		
Medium cutting		24 VBMT160404-24	●	●								●						
		VBMT160408-24	●	●								●						

● : Line up

Reference pages: External toolholder → [3-51](#) -, Internal toolholder → [4-27](#)

- Grade **1**
- Insert **2**
- Toolholder **3**
- Int. Toolholder **4**
- Threading **5**
- Grooving **6**
- Shaper **7**
- Endmill **8**
- Drilling Tool **9**
- Technical Reference **10**

Insert POSITIVE TYPE

- : Continuous cutting
- ◐ : Light interrupted cutting
- ✱ : Heavy interrupted cutting

VC

Rhombic, 35°
with hole
Positive 7°



Material	T9215	T9225	T6215	AH8005	AH8015	AH6225	AH6235	AH905	AH725	AH120	GT9530	AT9530	NS9530	Others
P Steel	●	●	✱	●				●	●		●	●	●	
M Stainless	●	●	●	●	●	●	✱	●	●					
N Non-ferrous														
S Superalloy				●	●			●	●					
H Hard material								●	●					

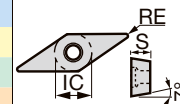

Application	Chipbreaker	Designation	Coated										Coated cermet		Cermet	Dimension (mm)				
			T9215	T9225	T6215	AH8005	AH8015	AH6225	AH6235	AH905	AH725	AH120	GT9530	AT9530	NS9530	RE	IC	S		
Application		PSF VCMT080202-PSF												●			0.2	4.76	2.38	
		VCMT080204-PSF	●	●							●			●			0.4	4.76	2.38	
		VCMT110302-PSF																0.2	6.35	3.18
		VCMT110304-PSF	●	●														0.4	6.35	3.18
		VCMT160404-PSF	●	●		●	●			●	●				●			0.4	9.525	4.76
		VCMT160408-PSF	●	●		●	●			●	●				●			0.8	9.525	4.76
Finishing		PF VCMT080202-PF															0.2	4.76	2.38	
		VCMT080204-PF																0.4	4.76	2.38
		VCMT160404-PF																0.4	9.525	4.76
		VCMT160408-PF																0.8	9.525	4.76
		TSF VCMT110302-TSF	●	●	●		●	●										0.2	6.35	3.18
		VCMT110304-TSF	●	●	●		●	●										0.4	6.35	3.18
Finishing to medium cutting		VCMT110308-TSF	●	●	●		●	●									0.8	6.35	3.18	
		VCMT160402-TSF	●	●	●		●	●									0.2	9.525	4.76	
		VCMT160404-TSF	●	●	●		●	●									0.4	9.525	4.76	
		VCMT160408-TSF	●	●	●		●	●									0.8	9.525	4.76	
		PSS VCMT110304-PSS	●	●	●			●	●		●							0.4	6.35	3.18
		VCMT110308-PSS	●	●	●			●	●		●							0.8	6.35	3.18
Finishing to medium cutting		VCMT160404-PSS	●	●	●		●	●		●							0.4	9.525	4.76	
		VCMT160408-PSS	●	●	●		●	●		●							0.8	9.525	4.76	
		PS VCMT110302-PS	●	●	●	●	●	●		●			●	●				0.2	6.35	3.18
		VCMT110304-PS	●	●	●	●	●	●		●			●	●				0.4	6.35	3.18
		VCMT110308-PS	●	●	●	●	●	●		●			●	●				0.8	6.35	3.18
		VCMT160402-PS	●	●	●		●	●										0.2	9.525	4.76
Finishing to medium cutting		VCMT160404-PS	●	●	●		●	●		●							0.4	9.525	4.76	
		VCMT160408-PS	●	●	●		●	●		●							0.8	9.525	4.76	
		TM VCMT110302-TM	●	●	●		●	●										0.2	6.35	3.18
		VCMT110304-TM	●	●	●		●	●										0.4	6.35	3.18
		VCMT110308-TM	●	●	●		●	●										0.8	6.35	3.18
		VCMT160402-TM	●	●	●		●	●										0.2	9.525	4.76
Finishing to medium cutting		VCMT160404-TM	●	●	●		●	●									0.4	9.525	4.76	
		VCMT160408-TM	●	●	●		●	●									0.8	9.525	4.76	

● : Line up

Insert POSITIVE TYPE

- : Continuous cutting
- ◐ : Light interrupted cutting
- ✱ : Heavy interrupted cutting

VC

Rhombic, 35°
with hole
Positive 7°



Material	Steel	Stainless	Non-ferrous	Superalloy	Hard material	Coated	Cermet	Uncoated
P	●●●✱	●●	●●	●●	●●	●●	●●	●●
M	●●	●●	●●	●●	●●	●●	●●	●●
N	●●	●●	●●	●●	●●	●●	●●	●●
S	●●	●●	●●	●●	●●	●●	●●	●●
H	●●	●●	●●	●●	●●	●●	●●	●●

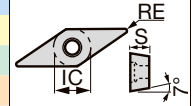

Application	Chipbreaker	Designation	Coated			Cermet	Uncoated	Dimension (mm)			
			T9215	T9225	AH8005	AH8015	AH905	NS9530	KS05F	RE	IC
Finishing to medium cutting for non-ferrous alloys	AL	VCGT160404-AL						●	0.4	9.525	4.76
		VCGT160408-AL						●	0.8	9.525	4.76
		VCGT160412-AL						●	1.2	9.525	4.76
		VCGT220520-AL						●	2	12.7	5.56
		VCGT220530-AL						●	3	12.7	5.56
Finishing to medium cutting	All-round	VCMT160404		●	●	●			0.4	9.525	4.76
		VCMT160408		●	●	●			0.8	9.525	4.76
		VCMT160412		●	●	●			1.2	9.525	4.76
Medium cutting	24	VCMT160404-24	●	●		●			0.4	9.525	4.76
		VCMT160408-24	●	●		●			0.8	9.525	4.76

● : Line up

Reference pages: External toolholder → 3-54 -, Internal toolholder → 4-16 -

Grade 1
Insert 2
Ext. Toolholder 3
Int. Toolholder 4
Threading 5
Grooving 6
Shaper 7
Endmill 8
Drilling Tool 9
Technical Reference 10

Insert POSITIVE TYPE

● : Continuous cutting
● : Light interrupted cutting
✱ : Heavy interrupted cutting

VC

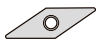

Rhombic, 35°
with hole
Positive 7°

Material	Coated	650	ST4	DM4	DT4	QM3	TM4	VM1	ZM3
P Steel							●	●	●
M Stainless		●	●	●				●	●
N Non-ferrous								●	●
S Superalloy		●	●	●				●	●
H Hard material								●	●

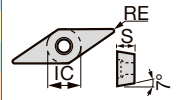

Application	Chipbreaker	Designation	Coated							Dimension (mm)			
			650	ST4	DM4	DT4	QM3	TM4	VM1	ZM3	RE	IC	S
													0.03
Finishing	AZ7	VCGT110300AZ7					●		●		0.03	6.35	3.18
		VCGT110301MAZ7					●		●		0.08	6.35	3.18
		VCGT110302MAZ7					●		●		0.18	6.35	3.18
		VCGT110304MAZ7					●		●		0.38	6.35	3.18
	TMV	VCGT110302MRTMV	●	●				●			0.18	6.35	3.18
		VCGT110304MRTMV	●	●				●			0.38	6.35	3.18
C	YL	VCGT110301MYL	●	●	●	●	●	●			0.08	6.35	3.18
		VCGT110302MYL	●	●	●	●	●	●			0.18	6.35	3.18
		VCGT110304MYL	●	●	●	●	●	●			0.38	6.35	3.18
Light cut	AM3	VCGT110300FNAM3				●		●	●		0.03	6.35	3.18
		VCGT110301MFNAM3	●		●	●	●	●			0.08	6.35	3.18
		VCGT110301FNAM3							●	●	0.1	6.35	3.18
		VCGT110302MFNAM3	●		●	●	●	●			0.18	6.35	3.18
		VCGT110302FNAM3							●	●	0.2	6.35	3.18
		VCGT110304MFNAM3	●		●	●	●	●			0.38	6.35	3.18
		VCGT110302FNAM3			●						0.2	6.35	3.18
		VCGT110304FNAM3			●						0.4	6.35	3.18
V	U	VCGT110300RU							●	●	0.03	6.35	3.18
		VCGT110301MRU				●					0.08	6.35	3.18
		VCGT110301RU							●	●	0.1	6.35	3.18
		VCGT110302MRU				●					0.18	6.35	3.18
		VCGT110302RU							●	●	0.2	6.35	3.18
UHG	VCET1103008RUHG								●		0.08	6.35	3.18
U-WP	U-WP	VCGT1103005RU-WP							●	●	0.05	6.35	3.18
		VCGT110301RU-WP							●	●	0.1	6.35	3.18
		VCGT1103005RSX-WP							●	●	0.05	6.35	3.18
		VCGT110301RSX-WP							●	●	0.1	6.35	3.18

● : Line up

Reference pages: External toolholder → 3-54 -, Internal toolholder → 4-16 -

Insert POSITIVE TYPE

● : Continuous cutting
 ● : Light interrupted cutting
 * : Heavy interrupted cutting

VC

Rhombic, 35°
 with hole
 Positive 7°



Material	Steel	Stainless	Non-ferrous	Superalloy	Hard material
P	●				
M		●●●			
N			●●●		
S				●●●	
H					●●●

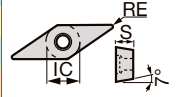

Application	Chipbreaker	Designation	Coated							Uncoated	Dimension (mm)			
			650	ST4	DM4	DT4	QM3	TM4	VM1	ZM3	KM1	RE	IC	S
Middle Cut	CL	VCGT110202MCL			●	●	●	●				0.18	6.35	2.38
		VCGT110301MCL	●	●	●	●	●	●				0.08	6.35	3.18
		VCGT110302MCL	●	●	●	●	●	●				0.18	6.35	3.18
	2M	VCGT130300FR2M			●							-	7.94	3.18
		VCGT130300FL2M			●							-	7.94	3.18
VCGT130301FR2M				●							-	7.94	3.18	
VCGT130301FL2M				●							-	7.94	3.18	
Non-ferrous	H	VCGW110300H								●	0.03	6.35	3.18	
		VCGW110301H								●	0.1	6.35	3.18	
		VCGW110302H								●	0.2	6.35	3.18	

● : Line up

Features of VCGT-WP insert

NTK WP style inserts have a wiper facet design. The insert has a 0.2mm flat on the cutting edge when the insert is set into the toolholder. The flat on the cutting edge ensures a superior surface when feed rates are increased. WP style inserts can be used in toolholders: SVJC

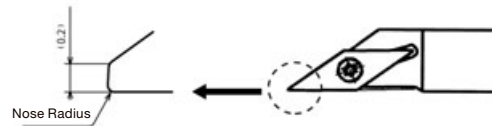

Insert POSITIVE TYPE / DOUBLE SIDE

VX

Rhombic, 35°
 with hole



Material	Steel	Stainless	Non-ferrous	Superalloy	Hard material
P	●●				
M		●●			
N			●●		
S				●●	
H					●●

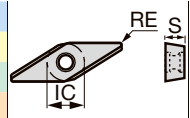

Application	Chipbreaker	Designation	Coated	Dimension (mm)		
			SH725	RE	IC	S
Finishing (sharp edge)	JRP	VXGU09T201MFRE-JRP**	●	<0.1*	5.56	2.47
		VXGU09T201MFLE-JRP**	●	<0.1*	5.56	2.47
		VXGU09T202MFRE-JRP**	●	<0.2*	5.56	2.47
		VXGU09T202MFLE-JRP**	●	<0.2*	5.56	2.47
Finishing to medium cutting (sharp edge)	JS	VXGU09T201MFR-JS ⁽¹⁾	●	<0.1*	5.56	2.47
		VXGU09T201MFL-JS ⁽¹⁾	●	<0.1*	5.56	2.47
		VXGU09T202MFR-JS ⁽¹⁾	●	<0.2*	5.56	2.47
		VXGU09T202MFL-JS ⁽¹⁾	●	<0.2*	5.56	2.47
		VXGU09T204MFR-JS ⁽¹⁾	●	<0.4*	5.56	2.47
				<0.4*	5.56	2.47

*Corner radius (RE) with a sign of inequality (<) means minus tolerance.

** For external turning applications

(1) Due to chipbreaker profile, max ap for face or ID turning is 1 mm

● : Line up

Reference pages: VC: External toolholder → 3-54 -, Internal toolholder → 4-16 -
 VX: External toolholder → 3-70 -

Grade 1
 Insert 2
 Toolholder 3
 Ext. Toolholder 4
 Int. Toolholder 5
 Threading 6
 Grooving 7
 Shaper 8
 Endmill 9
 Drilling Tool 10
 Technical Reference

Insert POSITIVE TYPE

● : Continuous cutting
 ● : Light interrupted cutting
 ✱ : Heavy interrupted cutting

VP

Rhombic, 35°
with hole
Positive 11°



	P	M	N	S	H	650	ST4	DM4	DT4	QM3	TM4	VM1	ZM3	Dimension (mm)		
Steel	●															
Stainless		●														
Non-ferrous			●													
Superalloy				●												
Hard material					●											

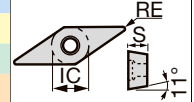

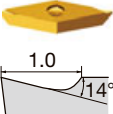
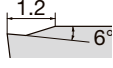
Application	Chipbreaker	Designation	Coated										Dimension (mm)						
			650	ST4	DM4	DT4	QM3	TM4	VM1	ZM3	RE	IC	S						
Finishing 	KHG	VPET0802005LKHG														0.05	4.76	2.38	
		VPET0802008RKHG				●				●	●						0.08	4.76	2.38
		VPET0802008LKHG											●				0.08	4.76	2.38
		VPET0802018RKHG											●	●			0.18	4.76	2.38
		VPET0802018LKHG												●			0.18	4.76	2.38
		VPET080202RKHG												●	●		0.2	4.76	2.38
		VPET080202LKHG													●		0.2	4.76	2.38
		VPET1103005RKHG												●	●		0.05	6.35	3.18
		VPET1103005LKHG													●		0.05	6.35	3.18
		VPET1103008RKHG												●	●		0.08	6.35	3.18
		VPET1103008LKHG													●		0.08	6.35	3.18
		VPET1103018RKHG												●	●		0.18	6.35	3.18
		VPET1103018LKHG													●		0.18	6.35	3.18
		VPET110302RKHG												●	●		0.2	6.35	3.18
		VPET110302LKHG													●		0.2	6.35	3.18
Light cut 	AM3	VPGT110300FNAM3							●			●				0.03	6.35	3.18	
		VPGT110301MFNAM3						●		●	●	●					0.08	6.35	3.18
		VPGT110302MFNAM3						●		●	●	●					0.18	6.35	3.18
	UHG	VPET0802008LUHG									●						0.08	4.76	2.38
		VPET0802008RUHG									●						0.08	4.76	2.38

● : Line up

Insert POSITIVE TYPE

- : Continuous cutting
- ◐ : Light interrupted cutting
- ◑ : Heavy interrupted cutting

WB



**Trigon, 80°
with hole
Positive 5°**

Material	Steel	Stainless	Non-ferrous	Superalloy	Hard material	Coated	Cermet	Uncoated
P	●	◐	◐	◐	◐	●	●	●
M	●	●	●	●	●	●	●	●
N	●	●	●	●	●	●	●	●
S	●	●	●	●	●	●	●	●
H	●	●	●	●	●	●	●	●

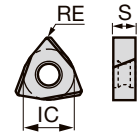

Application	Chipbreaker	Designation	Coated				Cermet	Uncoated		Dimension (mm)		
			GH110	SH7025	SH725	SH730	NS9530	TH10	UX30	RE	IC	S
Finishing (sharp edge)		JS WBG030101FR-JS	●	●						<0.1*	3.97	1.59
		WBG030101FL-JS	●	●						<0.1*	3.97	1.59
		WBG030102FR-JS	●	●						<0.2*	3.97	1.59
		WBG030102FL-JS	●	●						<0.2*	3.97	1.59
		WBG030104FR-JS	●	●						<0.4*	3.97	1.59
		WBG030104FL-JS	●	●						<0.4*	3.97	1.59
Finishing		JS WBG030101R-JS			●					<0.1	3.97	1.59
		WBG030101L-JS			●					<0.1	3.97	1.59
		WBG030102R-JS			●					<0.2	3.97	1.59
		WBG030102L-JS			●					<0.2	3.97	1.59
		WBG030104R-JS			●					<0.4	3.97	1.59
		WBG030104L-JS			●					<0.4	3.97	1.59
Finishing (sharp edge)		W08 WBG030100FL-W08	●	●						0.03	3.97	1.59
		WBG030100FR-W08		●						0.03	3.97	1.59
		WBG030101FL-W08	●	●						0.1	3.97	1.59
		WBG030101FR-W08		●						0.1	3.97	1.59
		WBG030102FL-W08	●	●						0.2	3.97	1.59
		WBG030102FR-W08	●	●						0.2	3.97	1.59
		WBG030104FL-W08	●	●						0.4	3.97	1.59
		WBG030104FR-W08	●	●						0.4	3.97	1.59
Finishing		W08 WBG030100R-W08			●					0.03	3.97	1.59
		WBG030100L-W08			●	●	●	●		0.03	3.97	1.59
		WBG030101R-W08			●					0.1	3.97	1.59
		WBG030101L-W08			●			●		0.1	3.97	1.59
		WBG030102R-W08			●					0.2	3.97	1.59
		WBG030102L-W08	●	●	●		●	●		0.2	3.97	1.59
		WBG030104R-W08			●					0.4	3.97	1.59
		WBG030104L-W08	●	●	●		●	●		0.4	3.97	1.59
		W11 WBG060102L-W11	●			●				0.2	3.97	1.59
		WBG060104L-W11				●				0.4	3.97	1.59
		WBG080202L-W11				●				0.2	4.76	2.38
		WBG080204L-W11				●				0.4	4.76	2.38

*Corner radius (RE) with a sign of inequality (<) means minus tolerance.

● : Line up

Insert POSITIVE TYPE / DOUBLE SIDE

● : Continuous cutting
 ● : Light interrupted cutting
 ✱ : Heavy interrupted cutting

WX



**Trigon, 80°
with hole**

P Steel	●	●●	●●	●●	●●													
M Stainless	●	●●	●●															
N Non-ferrous																		
S Superalloy	●	●																
H Hard material																		

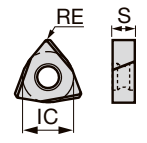

Application	Chipbreaker	Designation	Coated		Coated cermet	Cermet	Uncoated	Dimension (mm)			
			AH725	AH8015	SH725	GT9530	NS9530	KS05F	RE	IC	S
Finishing		JSS WXGU040301MFR-JSS		●					<0.1*	6.35	3.18
		WXGU040301MFL-JSS		●					<0.1*	6.35	3.18
		WXGU040302MFR-JSS		●					<0.2*	6.35	3.18
		WXGU040302MFL-JSS		●					<0.2*	6.35	3.18
Finishing		JSS WXGU040301MR-JSS	●						<0.1*	6.35	3.18
		WXGU040301ML-JSS	●						<0.1*	6.35	3.18
		WXGU040302MR-JSS	●						<0.2*	6.35	3.18
		WXGU040302ML-JSS	●						<0.2*	6.35	3.18
Finishing to medium cutting		SS WXGU040302R-SS	●	●		●		●	0.2	6.35	3.18
		WXGU040302L-SS	●	●		●		●	0.2	6.35	3.18
		WXGU040304R-SS	●	●		●		●	0.4	6.35	3.18
		WXGU040304L-SS	●	●		●		●	0.4	6.35	3.18
Finishing		TSW WXGU040304R-TSW	●	●		●			0.4	6.35	3.18
		WXGU040304L-TSW	●	●		●			0.4	6.35	3.18
		WXGU040308R-TSW	●	●		●			0.8	6.35	3.18
		WXGU040308L-TSW	●	●		●			0.8	6.35	3.18
Finishing to medium cutting (sharp edge)		JS WXGU040301MFR-JS ⁽¹⁾		●					<0.1*	6.35	3.18
		WXGU040301MFL-JS ⁽¹⁾		●					<0.1*	6.35	3.18
		WXGU040302MFR-JS ⁽¹⁾		●					<0.2*	6.35	3.18
		WXGU040302MFL-JS ⁽¹⁾		●					<0.2*	6.35	3.18
		WXGU040304MFR-JS ⁽¹⁾		●					<0.4*	6.35	3.18
		WXGU040304MFL-JS ⁽¹⁾		●					<0.4*	6.35	3.18
Finishing to medium cutting (sharp edge)		JTS WXGU040301MFR-JTS		●					<0.1*	6.35	3.18
		WXGU040301MFL-JTS		●					<0.1*	6.35	3.18
		WXGU040302MFR-JTS		●					<0.2*	6.35	3.18
		WXGU040302MFL-JTS		●					<0.2*	6.35	3.18
Finishing to medium cutting		JTS WXGU040301MR-JTS	●						<0.1*	6.35	3.18
		WXGU040301ML-JTS	●						<0.1*	6.35	3.18
		WXGU040302MR-JTS	●						<0.2*	6.35	3.18
		WXGU040302ML-JTS	●						<0.2*	6.35	3.18
Finishing to medium cutting		TS WXGU040302R-TS	●	●		●		●	0.2	6.35	3.18
		WXGU040302L-TS	●	●		●		●	0.2	6.35	3.18
		WXGU040304R-TS	●	●		●		●	0.4	6.35	3.18
		WXGU040304L-TS	●	●		●		●	0.4	6.35	3.18
		WXGU040308R-TS	●	●		●		●	0.8	6.35	3.18
		WXGU040308L-TS	●	●		●		●	0.8	6.35	3.18

*Corner radius (RE) with a sign of inequality (<) means minus tolerance.
 (1) Due to chipbreaker profile, max ap for face or ID turning is 1 mm.

● : Line up

YW



Rhombic, 25°
with hole
Positive 7°

P	M	N	S	H	Steel	Stainless	Non-ferrous	Superalloy	Hard material
●	●	●	●	●	●	●	●	●	●

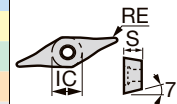

Application	Chipbreaker	Designation	Coated				Coated cermet	Cermet	Dimension (mm)		
			T9215	T9225	T6215	AH8015	AH6225	GT9530	NS9530	RE	IC
Finishing to medium cutting		ZF YWMT11T202-ZF	●	●	●	●	●	●	0.2	4.679	2.78
		YWMT11T204-ZF	●	●	●	●	●	●	0.4	4.679	2.78
		YWMT16T302-ZF	●	●	●	●	●	●	0.2	7.018	3.97
		YWMT16T304-ZF	●	●	●	●	●	●	0.4	7.018	3.97
		YWMT16T308-ZF	●	●	●	●	●	●	0.8	7.018	3.97
		ZM YWMT11T202-ZM	●	●	●	●	●	●	0.2	4.679	2.78
		YWMT11T204-ZM	●	●	●	●	●	●	0.4	4.679	2.78
		YWMT16T302-ZM	●	●	●	●	●	●	0.2	7.018	3.97
		YWMT16T304-ZM	●	●	●	●	●	●	0.4	7.018	3.97
		YWMT16T308-ZM	●	●	●	●	●	●	0.8	7.018	3.97

● : Line up

J10E



Back turning

P	M	N	S	H	Steel	Stainless	Non-ferrous	Superalloy	Hard material
●	●	●	●	●	●	●	●	●	●

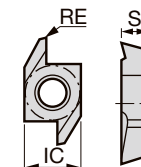

Application	Chipbreaker	Designation	Coated	Dimension (mm)		
			SH7025	RE	IC	S
Back turning		J10ER005BF	●	0.05	6.35	3.18
		J10EL005BF	●	0.05	6.35	3.18
		J10ER010BF	●	0.10	6.35	3.18
		J10EL010BF	●	0.10	6.35	3.18
		J10EL015BF	●	0.15	6.35	3.18
		J10ER015BF	●	0.15	6.35	3.18

● : Line up

Reference pages: YW: External toolholder → 3-87 -, Internal toolholder → 4-19 -
J10E: External toolholder → 3-98

Insert NEGATIVE TYPE

- : Continuous cutting
- ◐ : Light interrupted cutting
- ✱ : Heavy interrupted cutting

CN



Rhombic, 80°
with hole

	P	M	N	S	H	Coated	Coated cermet	Cermet	Uncoated
Steel	●	◐	◐	◐	◐	●	●	●	●
Stainless	●	◐	◐	◐	◐	●	●	●	●
Non-ferrous	◐	◐	◐	◐	◐	●	●	●	●
Superalloy	◐	◐	◐	◐	◐	●	●	●	●
Hard material	◐	◐	◐	◐	◐	●	●	●	●

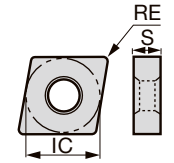

Application	Chipbreaker	Designation	Coated									Coated cermet		Cermet		Uncoated	Dimension (mm)		
			T9205	T9215	T9225	T9235	T6215	T505	T515	AH8015	AH6225	AH120	GT9530	AT9530	NS9530	NS520	TH10	RE	IC
Finishing		TF CNMG090402E-TF	●	●	●	●	●	●	●	●	●						0.2	9.525	4.76
		CNMG090404E-TF	●	●	●	●	●	●	●	●	●						0.4	9.525	4.76
		CNMG090408E-TF	●	●	●	●	●	●	●	●	●						0.8	9.525	4.76
		CNMG120404-TF	●	●	●	●	●	●	●	●	●				●		0.4	12.7	4.76
		CNMG120408-TF	●	●	●	●	●	●	●	●	●						0.8	12.7	4.76
		TSF CNMG090402E-TSF	●	●	●	●	●	●	●	●	●	●	●	●				0.2	9.525
Finishing for mild steel		CNMG090404E-ZF	●	●	●	●	●	●	●	●	●			●			0.2	9.525	4.76
		CNMG090408E-ZF	●	●	●	●	●	●	●	●	●			●			0.4	9.525	4.76
		CNMG120402-ZF	●	●	●	●	●	●	●	●	●			●			0.2	12.7	4.76
		CNMG120404-ZF	●	●	●	●	●	●	●	●	●	●	●				0.4	12.7	4.76
		CNMG120408-ZF	●	●	●	●	●	●	●	●	●	●	●				0.8	12.7	4.76
		CNMG120412-ZF	●	●	●	●	●	●	●	●	●	●					1.2	12.7	4.76
Finishing		AS CNMG120404-AS	●	●	●	●	●	●	●	●	●						0.4	12.7	4.76
		CNMG120408-AS	●	●	●	●	●	●	●	●	●						0.8	12.7	4.76
		CNMG120412-AS	●	●	●	●	●	●	●	●	●						1.2	12.7	4.76
Finishing		NS CNMG120404-NS															0.4	12.7	4.76
		CNMG120408-NS	●	●													0.8	12.7	4.76
Finishing		TS CNMG090402E-TS	●	●	●	●	●	●	●	●	●	●	●				0.2	9.525	4.76
		CNMG090404E-TS	●	●	●	●	●	●	●	●	●	●	●				0.4	9.525	4.76
		CNMG090408E-TS	●	●	●	●	●	●	●	●	●	●	●				0.8	9.525	4.76
		CNMG120404-TS	●	●	●	●	●	●	●	●	●	●	●	●			0.4	12.7	4.76
		CNMG120408-TS	●	●	●	●	●	●	●	●	●	●	●	●			0.8	12.7	4.76
CNMG120412-TS	●	●	●	●	●	●	●	●	●	●					1.2	12.7	4.76		

● : Line up

Reference pages: External toolholder → 3-81 -

Insert NEGATIVE TYPE

- : Continuous cutting
- ◐ : Light interrupted cutting
- ✱ : Heavy interrupted cutting

CN



Rhombic, 80°
with hole

Material	P Steel	M Stainless	N Non-ferrous	S Superalloy	H Hard material	T9205	T9215	T9225	T9235	T6215	T5105	T5115	AH8005	AH8015	AH6225	AH6235	AH120	GH330	GT9530	GT720	NS9530	NS520	TH10	RE	IC	S	
P Steel	●	◐	◐	◐	◐	●	●	●	●	●	●	●	●	●	●	●	●	●	●	●	●	●	●	●	●	●	●
M Stainless	●	●	◐	◐	◐	●	●	●	●	●	●	●	●	●	●	●	●	●	●	●	●	●	●	●	●	●	●
N Non-ferrous	●	●	●	◐	◐	●	●	●	●	●	●	●	●	●	●	●	●	●	●	●	●	●	●	●	●	●	●
S Superalloy	●	●	●	●	●	●	●	●	●	●	●	●	●	●	●	●	●	●	●	●	●	●	●	●	●	●	●
H Hard material	●	●	●	●	●	●	●	●	●	●	●	●	●	●	●	●	●	●	●	●	●	●	●	●	●	●	●

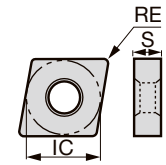

Application	Chipbreaker	Designation	Coated																		Coated cermet		Cermet		Uncoated	Dimension (mm)		
			T9205	T9215	T9225	T9235	T6215	T5105	T5115	AH8005	AH8015	AH6225	AH6235	AH120	GH330	GT9530	GT720	NS9530	NS520	TH10	RE	IC	S					
Finishing	SF	CNMG090304-SF					●								●										0.4	9.525	3.18	
		CNMG090308-SF					●								●											0.8	9.525	3.18
		CNMG120404-SF					●								●											0.4	12.7	4.76
		CNMG120408-SF					●								●											0.8	12.7	4.76
		CNMG120412-SF					●								●											1.2	12.7	4.76
	SS	CNMG090404E-SS														●	●									0.4	9.525	4.76
		CNMG090408E-SS														●	●									0.8	9.525	4.76
		CNMG120404-SS					●									●	●	●	●							0.4	12.7	4.76
		CNMG120408-SS					●									●	●	●	●							0.8	12.7	4.76
		CNMG120412-SS					●									●	●	●	●							1.2	12.7	4.76
HRF	CNMG120404-HRF													●	●										0.4	12.7	4.76	
	CNMG120408-HRF													●	●										0.8	12.7	4.76	
	CNMG120412-HRF													●	●										1.2	12.7	4.76	
Finishing (wiper)	FW	CNMG090404E-FW	●	●	●															●		●			0.4	9.525	4.76	
		CNMG090408E-FW	●	●	●															●		●			0.8	9.525	4.76	
		CNMG120404-FW		●																	●		●			0.4	12.7	4.76
		CNMG120408-FW	●	●	●																●		●			0.8	12.7	4.76
	AFW	CNMG120404-AFW		●	●																●		●			0.4	12.7	4.76
	CNMG120408-AFW	●	●	●	●															●					0.8	12.7	4.76	
Finishing	01	CNMG090302-01																							0.2	9.525	3.18	
		CNMG090304-01																								0.4	9.525	3.18
		CNMG090308-01																								0.8	9.525	3.18
		CNMG120402-01																						●	●	0.2	12.7	4.76
		CNMG120404-01																						●	●	0.4	12.7	4.76
		CNMG120408-01																						●	●	0.8	12.7	4.76
	11	CNMG120404-11																				●		●		0.4	12.7	4.76
		CNMG120408-11																				●	●	●		0.8	12.7	4.76

* Please see Tungaloy General Catalog vol.5 L011 - L015 about the adjustment of the machining program for rounding or taper machining by using SW/FW. Please contact our sales representatives if you have any question.

● : Line up

Insert NEGATIVE TYPE

- : Continuous cutting
- ◐ : Light interrupted cutting
- ✱ : Heavy interrupted cutting

CNRhombic, 80°
with hole

	P	M	N	S	H	Coated	Coated cermet	Cermet	Uncoated
Steel	●	●	●	●	●	●	●	●	●
Stainless	●	●	●	●	●	●	●	●	●
Non-ferrous	●	●	●	●	●	●	●	●	●
Superalloy	●	●	●	●	●	●	●	●	●
Hard material	●	●	●	●	●	●	●	●	●

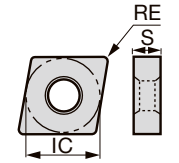

Application	Chipbreaker	Designation	Coated										Coated cermet	Cermet	Uncoated		Dimension (mm)					
			T9205	T9215	T9225	T6215	T515	T5115	AH8005	AH8015	AH6225	AH6235	AH905	GT9530	AT9530	NS9530	KS05F	KS20	RE	IC	S	
Medium cutting		HRM CNMG120404-HRM																0.4	12.7	4.76		
		CNMG120408-HRM																	0.8	12.7	4.76	
		CNMG120412-HRM																	1.2	12.7	4.76	
		CNMG160608-HRM																	0.8	15.875	6.35	
		CNMG160612-HRM																	1.2	15.875	6.35	
		CNMG190612-HRM																	1.2	19.05	6.35	
		CNMG190616-HRM																	1.6	19.05	6.35	
		Medium cutting (wiper)		SW CNMG090408E-SW	●	●	●			●										0.8	9.525	4.76
CNMG090412E-SW	●			●	●			●										1.2	9.525	4.76		
CNMG120408-SW	●			●	●		●	●										0.8	12.7	4.76		
CNMG120412-SW	●			●	●		●	●										1.2	12.7	4.76		
ASW CNMG120408-ASW	●			●	●									●					0.8	12.7	4.76	
CNMG120412-ASW	●			●	●														1.2	12.7	4.76	
Medium cutting				TQ CNMG120404-TQ		●	●								●	●	●			0.4	12.7	4.76
				CNMG120408-TQ		●	●								●	●	●			0.8	12.7	4.76
		TA CNMG120408-TA		●	●														0.8	12.7	4.76	
		CNMG120412-TA		●	●														1.2	12.7	4.76	
		Medium cutting		SA CNMG120404-SA				●												0.4	12.7	4.76
				CNMG120408-SA				●									●			0.8	12.7	4.76
				CNMG120412-SA				●									●			1.2	12.7	4.76
				CNMG190612-SA													●			1.2	19.05	6.35
CNMG190616-SA															●			1.6	19.05	6.35		
Medium cutting		HMM CNMG120404-HMM																0.4	12.7	4.76		
		CNMG120408-HMM													●			0.8	12.7	4.76		
		CNMG120412-HMM																1.2	12.7	4.76		
		CNMG160608-HMM																0.8	12.7	4.76		
		CNMG160612-HMM																1.2	19.05	6.35		
		CNMG160616-HMM																1.6	19.05	6.35		

* Please see Tungaloy General Catalog vol.5 L011 - L015 about the adjustment of the machining program for rounding or taper machining by using SW/FW. Please contact our sales representatives if you have any question.

● : Line up

Reference pages: External toolholder → 3-81 -

Insert NEGATIVE TYPE

- : Continuous cutting
- ◐ : Light interrupted cutting
- ✱ : Heavy interrupted cutting

CN



Rhombic, 80°
with hole

	P	M	N	S	H	Coated	Coated cermet	Cermet	Uncoated
Steel	●	◐	◐	◐	◐	●	●	●	●
Stainless	●	◐	◐	◐	◐	●	●	●	●
Non-ferrous	◐	◐	◐	◐	◐	●	●	●	●
Superalloy	◐	◐	◐	◐	◐	●	●	●	●
Hard material	◐	◐	◐	◐	◐	●	●	●	●

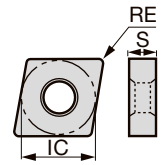

Application	Chipbreaker	Designation	Coated										Coated cermet	Cermet	Uncoated	Dimension (mm)										
			T9205	T9215	T9225	T9235	T515	AH8005	AH8015	AH6225	AH6235	AH725	AH110	AH120	GH330	GH110	GT720	NS9530	KS05F	TH10	RE	IC	S			
Medium cutting		P CNGG120404R-P																			●		0.4	12.7	4.76	
		CNGG120404L-P																				●		0.4	12.7	4.76
		CNGG120408R-P																				●		0.8	12.7	4.76
		CNGG120408L-P																				●		0.8	12.7	4.76
		S CNMG120404R-S		●	●				●	●							●	●					0.4	12.7	4.76	
		CNMG120404L-S		●	●				●	●							●	●					0.4	12.7	4.76	
		CNMG120408R-S		●	●				●	●							●	●					0.8	12.7	4.76	
		CNMG120408L-S		●	●				●	●							●	●					0.8	12.7	4.76	
		27 CNMG120404-27		●	●																●		0.4	12.7	4.76	
		CNMG120408-27		●	●	●															●		0.8	12.7	4.76	
		CNMG120412-27				●																	1.2	12.7	4.76	
		28 CNMG120404-28			●		●	●															0.4	12.7	4.76	
CNMG120408-28						●	●															0.8	12.7	4.76		
CNMG120412-28							●	●														1.2	12.7	4.76		
CNGG120402-28																						0.2	12.7	4.76		
CNGG120404-28																						0.4	12.7	4.76		
CNGG120408-28																						0.8	12.7	4.76		
	33 CNMG120408-33																			●		0.8	12.7	4.76		
	CNMG120416-33																			●		1.6	12.7	4.76		
	CNMG160612-33																			●		1.2	15.875	6.35		
	CNMG190612-33																			●		1.2	19.05	6.35		
	37 CNMG120404-37		●																		●	0.4	12.7	4.76		
	CNMG120408-37		●	●																	●	0.8	12.7	4.76		
	CNMG120412-37		●																			1.2	12.7	4.76		
	38 CNMG120404-38																					0.4	12.7	4.76		
	CNMG120408-38		●																			0.8	12.7	4.76		

● : Line up

Reference pages: External toolholder → 3-81 -

Grade
Insert
Ext. Toolholder
Int. Toolholder
Threading
Grooving
Shaper
Endmill
Drilling Tool
Technical Reference

Insert **NEGATIVE TYPE**

● : Continuous cutting
 ● : Light interrupted cutting
 ✱ : Heavy interrupted cutting

CN

Rhombic, 80°
with hole

Material	Steel	Stainless	Non-ferrous	Superalloy	Hard material	650	ST4	DM4	DT4	QM3	TM4	VM1	ZM3	UC1	Diamond coated
P	●	●	●	●	●	●	●	●	●	●	●	●	●	●	●
M	●	●	●	●	●	●	●	●	●	●	●	●	●	●	●
N	●	●	●	●	●	●	●	●	●	●	●	●	●	●	●
S	●	●	●	●	●	●	●	●	●	●	●	●	●	●	●
H	●	●	●	●	●	●	●	●	●	●	●	●	●	●	●

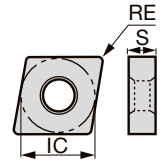

Application	Chipbreaker	Designation	Coated											Diamond coated	Dimension (mm)					
			650	ST4	DM4	DT4	QM3	TM4	VM1	ZM3	UC1	RE	IC	S						
Light cut		UL CNGG120404FNUL			●		●	●									0.4	12.7	4.76	
		CNGG120408FNUL			●		●	●										0.8	12.7	4.76
Middle Cut		ZP CNGG120404FNZP			●		●				●						0.4	12.7	4.76	
		CNGG120408FNZP			●		●				●						0.8	12.7	4.76	
		ZP CNMG120404FNZP													●			0.4	12.7	4.76
		CNMG120408FNZP													●			0.8	12.7	4.76

● : Line up

TN



Triangular with hole

P	Steel	●	◐	◐	✱	●	◐	◐									
M	Stainless	●	◐			◐	◐	◐									
N	Non-ferrous					◐	◐	◐									
S	Superalloy						◐	◐									
H	Hard material																

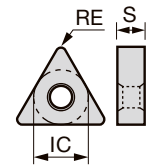

Application	Chipbreaker	Designation	Coated							Coated cermet		Cermet		Uncoated		Dimension (mm)		
			T9205	T9215	T9225	T9235	T6215	AH8015	AH6225	AH120	GT9530	AT9530	NS9530	NS520	TH10	RE	IC	S
Finishing	TF	TNMG110402E-TF	●	●		●	●	●				●				0.2	6.35	4.76
		TNMG110404E-TF	●	●		●	●	●				●				0.4	6.35	4.76
		TNMG110408E-TF	●	●		●	●	●				●				0.8	6.35	4.76
		TNMG160404-TF	●	●		●	●	●				●	●	●		0.4	9.525	4.76
		TNMG160408-TF	●	●		●	●	●				●	●			0.8	9.525	4.76
		TNMG110402E-TSF	●	●		●	●	●				●				0.2	6.35	4.76
		TNMG110404E-TSF	●	●		●	●	●				●				0.4	6.35	4.76
		TNMG110408E-TSF	●	●		●	●	●				●				0.8	6.35	4.76
		TNMG160402-TSF	●	●		●	●	●				●				0.2	9.525	4.76
		TNMG160404-TSF	●	●		●	●	●	●	●	●	●				0.4	9.525	4.76
	TNMG160408-TSF	●	●		●	●	●	●	●	●	●				0.8	9.525	4.76	
	TNMG160412-TSF	●	●		●	●	●	●		●					1.2	9.525	4.76	
Finishing for mild steel	PS	TNMG110402E-PS	●	●		●	●	●				●				0.2	6.35	4.76
		TNMG110404E-PS														0.4	6.35	4.76
		TNMG110408E-PS	●	●		●	●	●				●				0.8	6.35	4.76
		TNMG160402-PS	●	●		●	●	●				●				0.2	9.525	4.76
		TNMG160404-PS	●	●		●	●	●				●				0.4	9.525	4.76
		TNMG160408-PS	●	●		●	●	●				●				0.8	9.525	4.76
		TNMG160412-PS	●	●		●	●	●				●				1.2	9.525	4.76
Finishing for mild steel	ZF	TNMG160402-ZF	●	●		●	●	●				●				0.2	9.525	4.76
		TNMG160404-ZF	●	●		●	●	●	●	●	●					0.4	9.525	4.76
		TNMG160408-ZF	●	●		●	●	●				●				0.8	9.525	4.76
		TNMG160412-ZF	●	●		●	●	●				●				1.2	9.525	4.76
Finishing	AS	TNMG160404-AS			●	●						●				0.4	9.525	4.76
		TNMG160408-AS	●	●	●	●						●				0.8	9.525	4.76
		TNMG160412-AS	●	●	●											1.2	9.525	4.76
		NS	TNMG160404-NS		●	●						●				0.4	9.525	4.76
		TNMG160408-NS	●	●	●							●				0.8	9.525	4.76

● : Line up

Insert NEGATIVE TYPE

- : Continuous cutting
- ⦿ : Light interrupted cutting
- ⦿* : Heavy interrupted cutting

TN



Triangular with hole

P	Steel	●	⦿	⦿	⦿*	⦿*	⦿																		
M	Stainless	⦿	⦿																						
N	Non-ferrous																					⦿*			
S	Superalloy																					⦿*			
H	Hard material																								

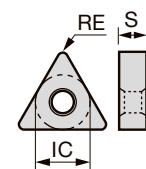

Application	Chipbreaker	Designation	Coated										Coated cermet		Cermet		Uncoated	Dimension (mm)				
			T9205	T9215	T9225	T9235	T6215	AH8005	AH8015	AH6225	AH6235	AH120	GH330	SH725	GT9530	AT9530	NS9530	NS520	KS20	RE	IC	S
Finishing	 TS	TNMG160404-TS	●	●	●	●	●	●	●	●				●	●	●	●		0.4	9.525	4.76	
		TNMG160408-TS	●	●	●	●	●	●	●	●	●				●	●	●	●		0.8	9.525	4.76
		TNMG160412-TS	●	●	●	●	●	●	●	●	●						●			1.2	9.525	4.76
	 SF	TNMG160404-SF				●		●												0.4	9.525	4.76
		TNMG160408-SF				●		●												0.8	9.525	4.76
		TNMG160412-SF				●		●												1.2	9.525	4.76
	 SS	TNMG110404E-SS						●	●											0.4	6.35	4.76
		TNMG110408E-SS						●	●											0.8	6.35	4.76
		TNMG160404-SS				●		●	●	●	●							●		0.4	9.525	4.76
		TNMG160408-SS				●		●	●	●	●							●		0.8	9.525	4.76
		TNMG160412-SS				●		●	●	●	●									1.2	9.525	4.76
		TNMG220404-SS				●		●	●	●	●									0.4	12.7	4.76
TNMG220408-SS					●		●	●	●	●									0.8	12.7	4.76	
TNMG220412-SS					●		●	●	●	●									1.2	12.7	4.76	
 HRF	TNMG160404-HRF				●	●													0.4	9.525	4.76	
	TNMG160408-HRF				●	●													0.8	9.525	4.76	
Finishing (wiper)	 FW	TNMG110404E-FW	●																0.4	6.35	4.76	
		TNMG110408E-FW	●																0.8	6.35	4.76	
		TNMG160404-FW	●																0.4	9.525	4.76	
		TNMG160408-FW	●																0.8	9.525	4.76	
Finishing (sharp edge)	 O1	TNGG160402F-O1										●							0.2	9.525	4.76	
		TNGG160404F-O1										●							0.4	9.525	4.76	
		TNGG160408F-O1										●							0.8	9.525	4.76	

* Please see Tungaloy General Catalog vol.5 L011 - L015 about the adjustment of the machining program for rounding or taper machining by using SW/FW. Please contact our sales representatives if you have any question.

● : Line up

Insert NEGATIVE TYPE

● : Continuous cutting
 ◐ : Light interrupted cutting
 ◑ : Heavy interrupted cutting

TN

Triangular with hole

Material	Coated	Coated cermet	Cermet	Uncoated
P Steel	●●●●	●●●●	●●●●	●
M Stainless	●●	●	●	●
N Non-ferrous	●●●●	●●●●	●●●●	●
S Superalloy	●			
H Hard material				

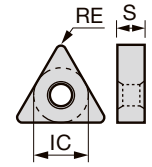

Application	Chipbreaker	Designation	Coated					Coated cermet		Cermet		Uncoated	Dimension (mm)		
			T9215	T9225	GH110	GH330	SH725	GT9530	GT720	NS9530	NS520		X407	TH10	RE
Finishing		01 TNGG110302-01							●				0.2	6.35	3.18
		TNGG110304-01							●				0.4	6.35	3.18
		TNGG110308-01							●	●			0.8	6.35	3.18
		TNGG160402-01		●					●	●		●	0.2	9.525	4.76
		TNGG160404-01		●					●	●		●	0.4	9.525	4.76
		TNGG160408-01		●					●	●			0.8	9.525	4.76
		TNGG160412-01						●		●			1.2	9.525	4.76
		Finishing		11 TNMG110304-11							●				0.4
TNMG110308-11									●				0.8	6.35	3.18
TNMG160402-11									●			●	0.2	9.525	4.76
TNMG160404-11					●				●			●	0.4	9.525	4.76
TNMG160408-11									●				0.8	9.525	4.76
TNMG220404-11									●				0.4	12.7	4.76
TNMG220408-11									●				0.8	12.7	4.76
Finishing for mild steel		17 TNMG160404-17	●	●					●				0.4	9.525	4.76
		TNMG160408-17	●						●				0.8	9.525	4.76
Finishing		A, C TNGG110304R-A						●		●			0.4	6.35	3.18
		TNGG110304L-A						●		●			0.4	6.35	3.18
		TNGG110308R-A						●		●			0.8	6.35	3.18
		TNGG110308L-A						●		●			0.8	6.35	3.18
		TNGG160304R-C							●		●		0.4	9.525	3.18
		TNGG160304L-C							●		●		0.4	9.525	3.18
		TNGG160308R-C							●		●		0.8	9.525	3.18
		TNGG160308L-C							●		●		0.8	9.525	3.18
		TNGG160400R-C								●		●	0.03	9.525	4.76
		TNGG160400L-C								●		●	0.03	9.525	4.76
		TNGG160402R-C						●		●	●	●	0.2	9.525	4.76
		TNGG160402L-C						●		●	●	●	0.2	9.525	4.76
		TNGG160404R-C			●	●		●		●	●	●	0.4	9.525	4.76
		TNGG160404L-C			●	●		●		●	●	●	0.4	9.525	4.76
		TNGG160408R-C			●	●		●		●	●	●	0.8	9.525	4.76
TNGG160408L-C			●	●		●		●	●	●	0.8	9.525	4.76		
Finishing		D TNGG220404R-D							●	●			0.4	12.7	4.76
		TNGG220404L-D							●	●			0.4	12.7	4.76
		TNGG220408R-D							●	●			0.8	12.7	4.76
		TNGG220408L-D							●	●			0.8	12.7	4.76

● : Line up

Reference pages: External toolholder → [3-74](#) -

Grade
1
2
3
4
5
6
7
8
9
10
Insert
Toolholder
Ext. Toolholder
Int. Toolholder
Threading
Grooving
Shaper
Endmill
Drilling Tool
Technical Reference

Insert NEGATIVE TYPE

- : Continuous cutting
- ◐ : Light interrupted cutting
- ✱ : Heavy interrupted cutting

TN



Triangular with hole

Material	P Steel	M Stainless	N Non-ferrous	S Superalloy	H Hard material	Coated	Coated cermet	Cermet	Un-coated
●	●	●	●	●	●	●	●	●	●
◐	◐	◐	◐	◐	◐	◐	◐	◐	◐
✱	✱	✱	✱	✱	✱	✱	✱	✱	✱

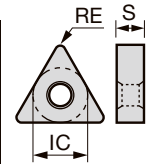

Application	Chipbreaker	Designation	Coated													Coated cermet	Cermet		Un-coated	Dimension (mm)								
			T9205	T9215	T9225	T9235	T6215	T505	T515	T5105	T5115	T5125	AH8005	AH8015	AH6225	AH6235	AH725	AH110	AH120	GT720	NS9530	NS520	TH10	RE	IC	S		
Medium cutting		DM TNMG160404-DM	●	●	●	●																		0.4	9.525	4.76		
		TNMG160408-DM	●	●	●	●								●	●										0.8	9.525	4.76	
		TNMG160412-DM	●	●		●								●	●										1.2	9.525	4.76	
		All-round TNMG110304		●	●						●	●	●									●		●	0.4	6.35	3.18	
		TNMG110308		●	●						●	●	●										●		●	0.8	6.35	3.18
		TNMG160304																					●		●	0.4	9.525	3.18
		TNMG160308																					●		●	0.8	9.525	3.18
		TNMG160404	●	●	●	●		●	●	●	●	●	●					●	●				●	●	●	0.4	9.525	4.76
		TNMG160408	●	●	●	●		●	●	●	●	●	●					●	●	●	●		●	●	●	0.8	9.525	4.76
		TNMG160412	●	●	●	●		●	●	●	●	●	●					●	●	●	●		●		●	1.2	9.525	4.76
		TNMG160416		●	●	●					●	●	●										●		●	1.6	9.525	4.76
		TNMG160420		●	●	●																	●		●	2	9.525	4.76
		TNMG220408	●	●	●	●						●	●	●									●		●	0.8	12.7	4.76
		TNMG220412	●	●	●	●						●	●	●									●		●	1.2	12.7	4.76
		TNMG220416		●	●	●						●	●	●									●		●	1.6	12.7	4.76
TNMG270608			●																		●		●	0.8	15.875	6.35		
TNMG270612			●																		●		●	1.2	15.875	6.35		
TNMG270616																					●		●	1.6	15.875	6.35		
Medium cutting		SM TNMG110404E-SM					●																	●	0.4	6.35	4.76	
		TNMG110408E-SM					●																		●	0.8	6.35	4.76
		TNMG160404-SM					●																●	●	●	0.4	9.525	4.76
	TNMG160408-SM					●																●	●	●	0.8	9.525	4.76	
	TNMG160412-SM					●																●		●	1.2	9.525	4.76	
	TNMG220408-SM					●																●		●	0.8	12.7	4.76	
TNMG220412-SM					●																●		●	1.2	12.7	4.76		
	SDM TNMG160404-SDM					●																		●	0.4	9.525	4.76	
	TNMG160408-SDM					●																			●	0.8	9.525	4.76
	TNMG160412-SDM					●																			●	1.2	9.525	4.76
	HRM TNMG160404-HRM												●	●											0.4	9.525	4.76	
	TNMG160408-HRM												●	●											0.8	9.525	4.76	
	TNMG160412-HRM												●	●											1.2	9.525	4.76	
Medium cutting (wiper)		SW TNMG110408E-SW	●																						0.8	6.35	4.76	
		TNMG110412E-SW	●																							1.2	6.35	4.76
		TNMG160408-SW	●																							0.8	9.525	4.76
		TNMG160412-SW	●																							1.2	9.525	4.76

* Please see Tungaloy General Catalog vol.5 L011 - L015 about the adjustment of the machining program for rounding or taper machining by using SW/FW. Please contact our sales representatives if you have any question.

● : Line up

Reference pages: External toolholder → 3-74 -

Grade 1
Insert 2
Ext. Toolholder 3
Int. Toolholder 4
Threading 5
Grooving 6
Shaper 7
Endmill 8
Drilling Tool 9
Technical Reference 10

Insert NEGATIVE TYPE

- : Continuous cutting
- ◐ : Light interrupted cutting
- ◑ : Heavy interrupted cutting

TN

Triangular with hole

	P	M	N	S	H															
Steel	●	◐	◑	◑			●	●	●	●	●	●	●	●	●					
Stainless	●	◐					●	●	●	●	●	●	●	●	●					
Non-ferrous			●	●	●		●	●	●	●	●	●	●	●	●					
Superalloy							●	●	●	●										
Hard material																				

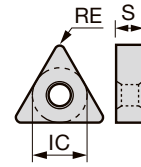

Application	Chipbreaker	Designation	Coated							Coated cermet		Cermet	Uncoated		Dimension (mm)					
			T9215	T9225	T6215	AH6225	AH6235	AH905	AH120	GH110	GH330	SH725	GT9530	AT9530	NS9530	KS20	TH10	RE	IC	S
Medium cutting		TQ TNMG160404-TQ	●	●													0.4	9.525	4.76	
		TNMG160408-TQ	●	●													0.8	9.525	4.76	
Medium cutting		TA TNMG160404-TA	●	●													0.4	9.525	4.76	
		TNMG160408-TA	●	●													0.8	9.525	4.76	
		TNMG160412-TA	●	●													1.2	9.525	4.76	
		SA TNMG160404-SA			●	●	●	●									0.4	9.525	4.76	
		TNMG160408-SA			●	●	●	●							●		0.8	9.525	4.76	
		TNMG160412-SA			●	●	●	●							●		1.2	9.525	4.76	
Medium cutting		TNMG220408-SA			●	●	●	●								0.8	12.7	4.76		
		TNMG220412-SA			●	●	●									1.2	12.7	4.76		
		HMM TNMG160404-HMM						●								0.4	9.525	4.76		
		TNMG160408-HMM						●								0.8	9.525	4.76		
		TNMG160412-HMM						●								1.2	9.525	4.76		
Medium cutting (sharp edge)		P TNGG160402FR-P															0.2	9.525	4.76	
		TNGG160402FL-P																0.2	9.525	4.76
		TNGG160404FR-P																0.4	9.525	4.76
		TNGG160404FL-P																0.4	9.525	4.76
		TNGG160408FR-P																0.8	9.525	4.76
		TNGG160408FL-P																0.8	9.525	4.76
Medium cutting		P TNGG160402R-P							●	●		●		●		0.2	9.525	4.76		
		TNGG160402L-P							●	●		●		●		0.2	9.525	4.76		
		TNGG160404R-P							●	●		●		●		0.4	9.525	4.76		
		TNGG160404L-P							●	●		●		●		0.4	9.525	4.76		
		TNGG160408R-P							●	●		●		●		0.8	9.525	4.76		
		TNGG160408L-P							●	●		●		●		0.8	9.525	4.76		

● : Line up

Reference pages: External toolholder → 3-74 -

Insert NEGATIVE TYPE

● : Continuous cutting
 ● : Light interrupted cutting
 ✱ : Heavy interrupted cutting

TN



Rhombic, 60°
with hole

	P	M	N	S	H	650	ST4	DM4	DT4	QM3	TM4	VM1	ZM3	UC1	Diamond coated
Steel															
Stainless		●●●													
Non-ferrous			●●●												
Superalloy				●●											
Hard material					●●										

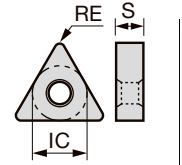

Application	Chipbreaker	Designation	Coated							Diamond coated	Dimension (mm)							
			650	ST4	DM4	DT4	QM3	TM4	VM1	ZM3	UC1	RE	IC	S				
Finishing	D1	TNEG160402FLD1								●						0.2	9.525	4.76
		TNEG160402FRD1								●						0.2	9.525	4.76
		TNEG160404FLD1								●						0.4	9.525	4.76
		TNEG160404FRD1								●						0.4	9.525	4.76
		TNEG160408FLD1								●						0.8	9.525	4.76
		TNEG160408FRD1								●						0.8	9.525	4.76
Light cut	TMV	TNGG160402MRTMV	●	●						●						0.18	9.525	4.76
		TNGG160404MRTMV	●	●						●						0.38	9.525	4.76
Light cut	UL	TNGG160401MFNUL	●	●	●					●	●					0.08	9.525	4.76
		TNGG160402MFNUL	●	●	●					●	●					0.18	9.525	4.76
		TNGG160404MFNUL	●	●	●					●	●					0.38	9.525	4.76
		TNGG160408MFNUL	●	●	●					●	●					0.78	9.525	4.76
Middle Cut	U2	TNGG160401FRU2										●	●			0.1	9.525	4.76
		TNGG160402FLU2			●								●			0.2	9.525	4.76
		TNGG160402FRU2			●								●			0.2	9.525	4.76
		TNGG160404FLU2			●								●			0.4	9.525	4.76
		TNGG160404FRU2			●								●			0.4	9.525	4.76
		TNGG160408FLU2			●								●			0.8	9.525	4.76
		TNGG160408FRU2			●								●			0.8	9.525	4.76
		ZP	TNGG160402FNZP		●		●	●	●	●							0.2	9.525
Middle Cut		TNGG160404FNZP		●		●	●	●	●							0.4	9.525	4.76
		TNGG160408FNZP		●		●	●	●	●							0.8	9.525	4.76
		TNMG160402FNZP												●		0.2	9.525	4.76
		TNMG160404FNZP												●		0.4	9.525	4.76
	TNMG160408FNZP												●		0.8	9.525	4.76	

● : Line up

Reference pages: External toolholder → 3-74 -

VN



Rhombic, 35°
with hole

	P	M	N	S	H	Coated	Coated cermet	Cermet
Steel	●	●	●	●	●	●	●	●
Stainless		●	●	●	●	●	●	●
Non-ferrous				●	●	●	●	●
Superalloy					●	●	●	●
Hard material								

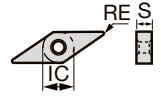

Application	Chipbreaker	Designation	Coated										Coated cermet			Cermet		Dimension (mm)				
			T9205	T9215	T9225	T9235	T6215	AH8005	AH8015	AH6225	AH6235	AH120	GH330	GT9530	GT720	AT9530	NS9530	NS520	RE	IC	S	
Application	Chipbreaker	TF VNMG120402E-TF	●	●	●	●	●	●	●								●		0.2	7.15	4.76	
		VNMG120404E-TF	●	●	●	●	●	●	●								●		0.4	7.15	4.76	
		VNMG120408E-TF	●	●	●	●	●	●	●								●		0.8	7.15	4.76	
		VNMG160404-TF	●	●	●	●	●	●	●								●		0.4	9.525	4.76	
		VNMG160408-TF	●	●	●	●	●	●	●					●			●		0.8	9.525	4.76	
		Finishing	Finishing	TSF VNMG120402E-TSF	●	●	●	●	●	●					●	●		●		0.2	7.15	4.76
				VNMG120404E-TSF	●	●	●	●	●	●					●	●		●		0.4	7.15	4.76
				VNMG120408E-TSF	●	●	●	●	●	●					●	●		●		0.8	7.15	4.76
				VNMG160402-TSF	●	●	●	●	●	●			●		●	●		●		0.2	9.525	4.76
				VNMG160404-TSF	●	●	●	●	●	●			●		●	●		●		0.4	9.525	4.76
VNMG160408-TSF	●			●	●	●	●	●			●		●	●		●		0.8	9.525	4.76		
VNMG160412-TSF	●			●	●	●	●	●										1.2	9.525	4.76		
PS VNMG120402E-PS	●			●	●	●	●	●									●		0.2	9.525	4.76	
VNMG120404E-PS	●			●	●	●	●	●									●		0.4	9.525	4.76	
VNMG120408E-PS	●			●	●	●	●	●									●		0.8	9.525	4.76	
Finishing for mild steel	Finishing for mild steel	ZF VNMG120404E-ZF	●	●	●	●	●	●								●		0.4	7.15	4.76		
		VNMG120408E-ZF	●	●	●	●	●	●								●		0.8	7.15	4.76		
		VNMG160402-ZF	●	●	●	●	●	●								●		0.25	9.525	4.76		
		VNMG160404-ZF	●	●	●	●	●	●					●	●		●		0.4	9.525	4.76		
		VNMG160408-ZF	●	●	●	●	●	●					●	●		●		0.8	9.525	4.76		
		VNMG160412-ZF	●	●	●	●	●	●								●		1.2	9.525	4.76		
Finishing	Shaper	TS VNMG160404-TS	●	●	●	●	●	●					●	●		●	●	0.4	9.525	4.76		
		VNMG160408-TS	●	●	●	●	●	●					●	●		●	●	0.8	9.525	4.76		
		VNMG160412-TS	●	●	●	●	●	●								●		1.2	9.525	4.76		
		SF VNMG160404-SF					●		●										0.4	9.525	4.76	
		VNMG160408-SF					●		●										0.8	9.525	4.76	
Finishing	Drilling Tool	SS VNMG120404E-SS					●		●	●								0.4	7.15	4.76		
		VNMG120408E-SS					●		●	●								0.8	7.15	4.76		
		VNMG160404-SS					●		●	●	●	●						0.4	9.525	4.76		
		VNMG160408-SS					●		●	●	●	●	●					0.8	9.525	4.76		
		VNMG160412-SS					●		●	●	●	●						1.2	9.525	4.76		
Finishing	Technical Reference	HRF VNMG160404-HRF					●	●										0.4	9.525	4.76		
		VNMG160408-HRF					●	●										0.8	9.525	4.76		

● : Line up

Reference pages: External toolholder → **3-85** -



Insert NEGATIVE TYPE

- : Continuous cutting
- ◐ : Light interrupted cutting
- ✱ : Heavy interrupted cutting

VN



Rhombic, 35°
with hole

P	Steel	●	●	●	✱	●															
M	Stainless	●	●		●	●		●	✱		●	●									
N	Non-ferrous							●	✱												
S	Superalloy				●	●															
H	Hard material																				

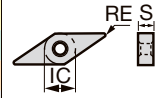

Application	Chipbreaker	Designation	Coated											Coated cermet		Uncoated		Dimension (mm)				
			T9215	T9225	T6215	AH8005	AH8015	AH6225	AH6235	AH905	AH110	AH120	GT9530	AT9530	KS05F	TH10	RE	IC	S			
Medium cutting	SDM 	VNMG160404-SDM			●			●	●									0.4	9.525	4.76		
		VNMG160408-SDM			●			●	●										0.8	9.525	4.76	
		VNMG160412-SDM			●			●	●										1.2	9.525	4.76	
	HRM 	VNMG160404-HRM				●	●												0.4	9.525	4.76	
		VNMG160408-HRM				●	●													0.8	9.525	4.76
		VNMG160412-HRM				●	●													1.2	9.525	4.76
	TQ 	VNMG160404-TQ		●	●								●	●		●			0.4	9.525	4.76	
		VNMG160408-TQ		●	●								●	●		●			0.8	9.525	4.76	
	HMM 	VNMG160404-HMM										●							0.4	9.525	4.76	
		VNMG160408-HMM										●							0.8	9.525	4.76	
		VNMG160412-HMM										●							1.2	9.525	4.76	
28 	VNMG160404-28				●	●						●			●			0.4	9.525	4.76		
	VNMG160408-28				●	●						●			●			0.8	9.525	4.76		
33 	VNMG160404-33		●												●			0.4	9.525	4.76		
	VNMG160408-33		●	●											●			0.8	9.525	4.76		

● : Line up

Reference pages: External toolholder → 3-85 -

Grade
Insert
Ext. Toolholder
Int. Toolholder
Threading
Grooving
Shaper
Endmill
Drilling Tool
Technical Reference

Insert NEGATIVE TYPE

- : Continuous cutting
- ◐ : Light interrupted cutting
- ◑ : Heavy interrupted cutting

YN

Rhombic, 25°
with hole

P Steel	●	●◐	●◑	*	●	●	●◐	●◑														●◐										
M Stainless	●◐				●		●◐																									
N Non-ferrous																																
S Superalloy							●																									
H Hard material																																

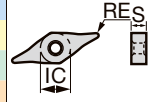

Application	Chipbreaker	Designation	Coated			Coated cermet		Cermet			Dimension (mm)				
			T9215	T9225	T9235	T6215	AH8015	AH6225	GT9530	NS9530		RE	IC	S	
Finishing for mild steel	ZF	YNMG160402-ZF	●	●	●	●	●	●	●				0.2	9.525	4.76
		YNMG160404-ZF	●	●	●	●	●	●	●				0.4	9.525	4.76
		YNMG160408-ZF	●	●	●	●	●	●	●				0.8	9.525	4.76
Medium cutting for mild steel	ZM	YNMG160404-ZM	●	●	●	●	●	●	●				0.4	9.525	4.76
		YNMG160408-ZM	●	●	●	●	●	●	●				0.8	9.525	4.76

● : Line up

CC

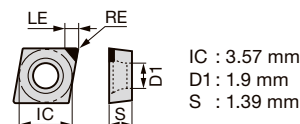

80° Rhombic with hole, Positive 7°

S Superalloy																			
H Hard material	●																		
Sintered metal		●●																	

Application	Designation	Dimension (mm)		No. of corners	Wiper	Standard	Problem				BX310	BX470								
		RE	LE				Burr	Finak wear	Crater wear	Chipping										
Precision finishing	1QP-CCGW03X102	0.2	1.4	1		○					●	●								
	1QP-CCGW03X104	0.4	1.3	1		○					●	●								

● : Line up

CC

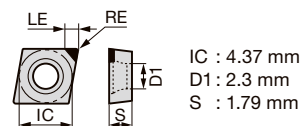

80° Rhombic with hole, Positive 7°

S Superalloy																			
H Hard material	●																		
Sintered metal		●●																	

Application	Designation	Dimension (mm)		No. of corners	Wiper	Standard	Problem				BX310	BX470								
		RE	LE				Burr	Finak wear	Crater wear	Chipping										
Precision finishing	1QP-CCGW04T102	0.2	1.9	1		○					●	●								
	1QP-CCGW04T104	0.4	1.8	1		○					●	●								

● : Line up



CBN Insert POSITIVE TYPE

- : Continuous cutting
- : Light interrupted cutting
- * : Heavy interrupted cutting

CC



80°Rhombic with hole, Positive 7°

S	Superalloy																	
H	Hard material	●	●	*	●	●	●	●	●	●	●	●	●	●	●	●	●	●
	Sintered metal	●	●															

Application	Designation	Dimension (mm)		No. of corners	Wiper	Standard	Problem				BXA10	BXA20	BR35F	BXM10	BXM20	BXA30	BXA40	BX310	BX330	BX360	BX470	BX480	BX930		
		RE	LE				Burr	Flank wear	Crater wear	Chipping															
Precision finishing	2QP-CCGW060202-LF	0.2	2.3	2			○				●	●													
	2QP-CCGW060202-L		2.3	2			○				●	●													
	2QP-CCGW060204-LF	0.4	2.3	2			○				●	●													
	2QP-CCGW060204-L		2.3	2			○				●	●													
	2QP-CCGW060208-LF	0.8	2.2	2			○				●	●													
	2QP-CCGW060208-L		2.2	2			○				●	●													
Finishing	2QP-CCGW060202	0.2	2.3	2		○					●	●		●	●	●	●				●	●	●		
	2QP-CCMW060202		2.3	2		○					●	●										●	●	●	
	2QP-CCGW060202-LC	0.4	2.3	2					○		●	●													
	2QP-CCGW060204		2.3	2		○					●	●		●	●	●	●					●	●		
	2QP-CCGW060204SR		2.3	2		○						●													
	2QP-CCMW060204		2.3	2		○							●						●	●	●				●
	Q-CCMW060204		2.5	1		○														●					
	2QP-CCGW060204-LC		2.3	2						○		●	●												
	2QP-CCGW060208	0.8	2.2	2		○					●	●													
	2QP-CCGW060208SR		2.2	2		○							●												
	2QP-CCMW060208		2.2	2		○																			
	2QP-CCGW060208-LC		2.2	2						○		●	●												

● : Line up

CC with chipbreaker



80°Rhombic with hole, Positive 7°

S	Superalloy																	
H	Hard material	●	●	*	●													
	Sintered metal	●	●		●													

Application	Designation	Dimension (mm)		No. of corners	Wiper	Standard	Problem				BXA10	BXA20	BR35F	BXM10													
		RE	LE				Burr	Flank wear	Crater wear	Chipping																	
Precision finishing	2QP-CCGT060204-HP	0.4	2.3	2		○					●	●	●	●													
	2QP-CCGT060204-HS		2.2	2		○					●	●	●	●													

● : Line up

Reference pages: External toolholder → 3-29 -, Internal toolholder → 4-12 -

CBN Insert POSITIVE TYPE

- : Continuous cutting
- ◐ : Light interrupted cutting
- ✱ : Heavy interrupted cutting

CP



80° Rhombic with hole, Positive 11°

S	Superalloy																		
H	Hard material	●	◐	✱	●	◐													
	Sintered metal																		

Application	Designation	Dimension (mm)		No. of corners	Wiper	Standard	Problem				BXA10	BXA20	BR35F	BXM10	BXM20							
		RE	LE				Burr	Finak wear	Crater wear	Chipping												
Finishing	2QP-CPGW080202	0.2	2.3	2		○					●	●										
	2QP-CPGW080204	0.4	2.3	2		○					●	●										
	2QP-CPGW080208	0.8	2.2	2		○					●	●										

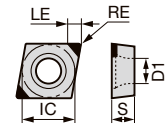

IC : 7.94 mm
D1 : 3.4 mm
S : 2.38 mm

● : Line up

CP



80° Rhombic with hole, Positive 11°

S	Superalloy																		
H	Hard material	●	◐																
	Sintered metal																		

Application	Designation	Dimension (mm)		No. of corners	Wiper	Standard	Problem				BXA10	BXA20										
		RE	LE				Burr	Finak wear	Crater wear	Chipping												
Finishing	2QP-CPGW090302	0.2	2.3	2		○					●	●										
	2QP-CPGW090304	0.4	2.3	2		○					●	●										
	2QP-CPGW090308	0.8	2.2	2		○					●	●										

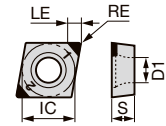

IC : 9.525 mm
D1 : 4.4 mm
S : 3.18 mm

● : Line up

DC

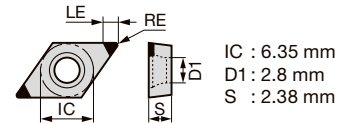

55° Rhombic with hole, Positive 7°

Application	Designation	Dimension (mm)				Problem																														
		RE	LE	No. of corners	Wiper	Standard	Burr	Finak wear	Crater wear	Chipping	BXA10	BXA20	BR35F	BXM10	BXM20	BXA30	BXA40	BX310	BX330	BX360	BX470	BX480	BX930													
																								Material												
														S	Superalloy																					
														H	Hard material	●	●	*	●	●	●	●	●	●	●	●	●	●	●	●	●	●	●	●	●	
														Sintered metal	●	●	●	●	●	●	●	●	●	●	●	●	●	●	●	●	●	●	●	●	●	●
Finishing	2QP-DCGW070202-LF	0.2	2.7	2			○			●	●																									
	2QP-DCGW070202-L		2.7	2			○			●	●																									
	2QP-DCGW070204-LF	0.4	2.5	2			○			●	●																									
	2QP-DCGW070204-L		2.5	2			○			●	●																									
	2QP-DCGW070208-LF	0.8	2.1	2			○			●	●																									
	2QP-DCGW070208-L		2.1	2			○			●	●																									
Medium cutting	2QP-DCGW070202	0.2	2.7	2		○				●	●		●	●	●	●																				
	2QP-DCGW070202SR		2.7	2		○						●																								
	2QP-DCMW070202		2.7	2		○										●	●	●																		
	2QP-DCGW070202-LC		2.7	2				○			●	●																								
	2QP-DCGW070204	0.4	2.5	2		○				●	●		●	●	●	●					●	●														
	2QP-DCGW070204SR		2.5	2		○						●																								
	2QP-DCMW070204		2.5	2		○										●	●	●					●													
	Q-DCMW070204		2.1	1		○											●																			
	2QP-DCGW070204-LC	2.5	2				○			●	●																									
	2QP-DCGW070208	0.8	2.1	2		○				●	●											●														
	2QP-DCGW070208SR		2.1	2		○						●																								
	2QP-DCGW070208-LC		2.1	2				○			●	●																								
2QP-DCGW070208-LC	2.1		2				○			●	●																									

● : Line up

DC with chipbreaker

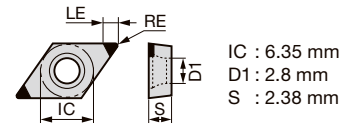

55° Rhombic with hole, Positive 7°

Application	Designation	Dimension (mm)				Problem																											
		RE	LE	No. of corners	Wiper	Standard	Burr	Finak wear	Crater wear	Chipping	BXA10	BXA20	BR35F	BXM10																			
															Material																		
														S	Superalloy																		
														H	Hard material	●	●	*	●														
														Sintered metal	●	●	●	●															
Precision finishing	2QP-DCGT070204-HP	0.4	2.5	2		○				●	●	●	●																				
	2QP-DCGT070204-HS		2.5	2		○					●	●	●	●																			

● : Line up

- : Continuous cutting
- : Light interrupted cutting
- : Heavy interrupted cutting

EP



75° Rhombic, with hole, Positive 11°

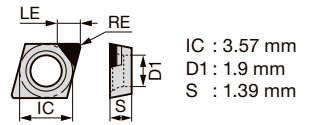

Application	Designation	Dimension (mm)		No. of corners	Wiper	Standard	Problem				BX310	BX470								
		RE	LE				Burr	Finak wear	Crater wear	Chipping										
		<div style="display: flex; justify-content: space-between;"> S Superalloy H Hard material S Sintered metal </div>																		
Finishing	1QP-EPGW03X102	0.2	1.4	1		○					●	●●								
	1QP-EPGW03X104	0.4	1.3	1		○					●	●								

● : Line up

EP



75° Rhombic, with hole, Positive 11°

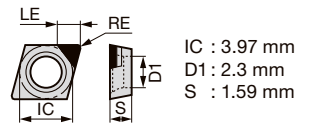

Application	Designation	Dimension (mm)		No. of corners	Wiper	Standard	Problem				BX310	BX470								
		RE	LE				Burr	Finak wear	Crater wear	Chipping										
		<div style="display: flex; justify-content: space-between;"> S Superalloy H Hard material S Sintered metal </div>																		
Finishing	1QP-EPGW040102	0.2	1.7	1		○					●	●								
	1QP-EPGW040104	0.4	1.6	1		○					●	●								

● : Line up

TC



Triangular Positive 7° with hole

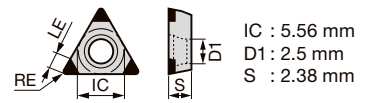

Application	Designation	Dimension (mm)		No. of corners	Wiper	Standard	Problem				BXA10	BXA20								
		RE	LE				Burr	Finak wear	Crater wear	Chipping										
		<div style="display: flex; justify-content: space-between;"> S Superalloy H Hard material S Sintered metal </div>																		
Finishing	3QP-TCGW090202	0.2	2.3	3		○					●	●								
	3QP-TCGW090204	0.4	2.2	3		○					●	●								
	3QP-TCGW090208	0.8	1.9	3		○					●	●								

● : Line up

Reference pages: EP: Internal toolholder → **4-9** -
 TC: External toolholder → **3-63**, Internal toolholder → **4-21** -

- Grade 1
- Insert 2
- Ext. Toolholder 3
- Int. Toolholder 4
- Threading 5
- Grooving 6
- Shaper 7
- Endmill 8
- Drilling Tool 9
- Technical Reference 10

CBN Insert POSITIVE TYPE

- : Continuous cutting
- ◐ : Light interrupted cutting
- ✱ : Heavy interrupted cutting

TC



Triangular Positive 7° with hole

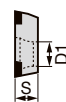

IC : 6.35 mm
D1 : 2.8 mm
S : 2.38 mm

Application	Designation	Dimension (mm)		No. of corners	Wiper	Standard	Problem				BXA10	BXA20								
		RE	LE				Burr	Finak wear	Crater wear	Chipping										
Finishing	3QP-TCGW110202	0.2	2.3	3		○					●	●								
	3QP-TCGW110204	0.4	2.2	3		○					●	●								
	3QP-TCGW110208	0.8	1.9	3		○					●	●								

● : Line up

TC



Triangular Positive 7° with hole

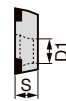

IC : 9.525 mm
D1 : 4.4 mm
S : 3.97 mm

Application	Designation	Dimension (mm)		No. of corners	Wiper	Standard	Problem				BXA10	BXA20								
		RE	LE				Burr	Finak wear	Crater wear	Chipping										
Finishing	3QP-TCGW16T302	0.2	2.3	3		○					●	●								
	3QP-TCGW16T304	0.4	2.2	3		○					●	●								
	3QP-TCGW16T308	0.8	1.9	3		○					●	●								

● : Line up

TP



Triangular Positive 11° with hole

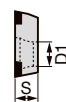

IC : 4.76 mm
D1 : 2.3 mm
S : 2.38 mm

Application	Designation	Dimension (mm)		No. of corners	Wiper	Standard	Problem				BXA10	BXA20	BXM10	BXM20	BXA30	BXA40	BX310	BX330	BX360	BX930											
		RE	LE				Burr	Finak wear	Crater wear	Chipping																					
Finishing	3QP-TPGW080202	0.2	2.3	3		○					●	●																			
	3QP-TPGW080204		2.2	3		○					●	●																			
	3QP-TPMW080204	0.4	2.2	3		○					●	●	●	●	●	●															
	Q-TPMW080204		2.2	1		○											●	●	●	●											
	3QP-TPGW080208	0.8	1.9	3		○					●	●																			

● : Line up

Reference pages: TC: External toolholder → 3-63, Internal toolholder → 4-21 -
TP: Internal toolholder → 4-22 -

TP



Triangular Positive 11° with hole

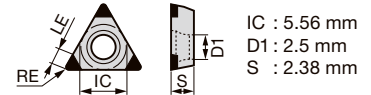

Application	Designation	Dimension (mm)			Wiper	Standard	Problem																				
		RE	LE	No. of corners			Burr	Flak wear	Crater wear	Chipping	BXA10	BXA20	BXM10	BXM20	BXA30	BXA40	BX310	BX330	BX360	BX930							
Finishing	3QP-TPGW090202	0.2	2.3	3	○						●	●															
	3QP-TPMW090202		2.3	3																		●	●	●			
	Q-TPMW090202		2.4	1																		●					
	3QP-TPGW090204	0.4	2.2	3	○							●	●	●	●	●											
	3QP-TPMW090204		2.2	3																			●	●	●	●	
	Q-TPMW090204		2.3	1																			●				
	3QP-TPGW090208	0.8	1.9	3	○							●	●														

● : Line up

TP



Triangular Positive 11° with hole

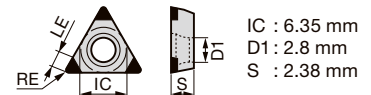

Application	Designation	Dimension (mm)			Wiper	Standard	Problem																					
		RE	LE	No. of corners			Burr	Flak wear	Crater wear	Chipping	BXA10	BXA20	BXM10	BXM20	BXA30	BXA40	BX310	BX330	BX360	BX470	BX930							
Finishing	3QP-TPGW110202	0.2	2.3	3	○							●	●															
	3QP-TPMW110202		2.3	3																		●	●	●		●		
	Q-TPMW110202		2.4	1																			●					
	3QP-TPGW110204	0.4	2.2	3	○								●	●	●	●	●											
	3QP-TPMW110204		2.2	3																				●	●	●		●
	Q-TPMW110204		2.2	1																				●				
	3QP-TPGW110208	0.8	1.9	3	○								●	●							●							

● : Line up

TP



Triangular Positive 11° with hole

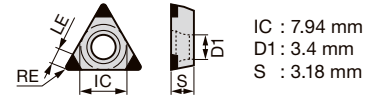

Application	Designation	Dimension (mm)		No. of corners	Wiper	Standard	Problem				Material															
		RE	LE				Burr	Flank wear	Crater wear	Chipping	BXA10	BXA20	BXM10	BXM20	BXA30	BXA40	BX310	BX330	BX360	BX480	BX930					
Finishing	3QP-TPGW130302	0.2	2.3	3	○					●	●●	●	●●	●	●●	●	●●	●●●								
	3QP-TPMW130302		2.3	3						●	●●	●	●●	●	●●	●	●●	●●●								
	Q-TPMW130302	2.4	1	○																						
	3QP-TPGW130304	0.4	2.2	3	○						●	●	●	●	●	●										
	3QP-TPMW130304		2.2	3	○											●	●									
	Q-TPMW130304		2.3	1	○												●									
	3QP-TPGW130308	0.8	1.9	3	○						●	●														

● : Line up

TP



Triangular Positive 11° with hole

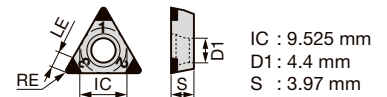

Application	Designation	Dimension (mm)		No. of corners	Wiper	Standard	Problem				Material																
		RE	LE				Burr	Flank wear	Crater wear	Chipping	BXA10	BXA20	BXM10	BXM20	BXA30	BXA40	BX310	BX330	BX360	BX480	BX930						
Finishing	3QP-TPGW16T302	0.2	2.3	3	○																						
	3QP-TPGW16T304		2.2	3																							
	3QP-TPMW16T304	0.4	2.2	3	○											●	●	●									
	Q-TPGW16T304		2.3	1	○												●										
	3QP-TPGW16T308	0.8	1.9	3	○											●											
	3QP-TPMW16T308		1.9	3	○											●											

● : Line up

Grade 1
 Insert 2
 Ext. Toolholder 3
 Int. Toolholder 4
 Threading 5
 Grooving 6
 Shaper 7
 Endmill 8
 Drilling Tool 9
 Technical Reference 10

CBN Insert POSITIVE TYPE

- : Continuous cutting
- : Light interrupted cutting
- ⊛ : Heavy interrupted cutting

TP



IC : 9.525 mm
 D1 : 4.4 mm
 S : 4.76 mm



Triangular Positive 11° with hole

S	Superalloy																		
H	Hard material	●	●●	●	●●	●	●●	●	●●	●	●	●●							
	Sintered metal																		

Application	Designation	Dimension (mm)				Standard	Problem				BXA10	BXA20	BXM10	BXM20	BXA30	BXA40	BX310	BX330	BX360	BX930																			
		RE	LE	No. of corners	Wiper		Burr	Finak wear	Crater wear	Chipping																													
Finishing	3QP-TPGW160402	0.2	2.3	3		○					●	●																											
	3QP-TPGW160404		2.2	3		○					●	●	●	●	●	●																							
	3QP-TPMW160404	0.4	2.2	3		○											●	●	●	●																			
	Q-TPMW160404		2.3	1		○															●																		
	3QP-TPGW160408	0.8	1.9	3		○						●	●																										
	3QP-TPMW160408		1.9	3		○															●	●	●	●															
Q-TPMW160408		2	1		○																																		
Medium cutting	3QP-TPGW160402-H	0.2	2.3	3								●	●																										
	3QP-TPGW160404-H	0.4	2.2	3								●	●																										
	3QP-TPGW160408-H	0.8	1.9	3								●	●																										

● : Line up

Reference pages: Internal toolholder → 4-22 -

VB

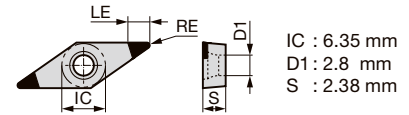

35° Rhombic with hole, Positive 5°

Application		Dimension (mm)		No. of corners	Wiper	Standard	Problem						S	H	Sintered metal
		RE	LE				Burr	Finak wear	Crater wear	Chipping	BXA10	BXA20			
Finishing	2QP-VBGW110202	0.2	3.5	2		O					●	●●			
	2QP-VBGW110204	0.4	3.1	2		O					●	●			
	2QP-VBGW110208	0.8	2.2	2		O					●	●			

● : Line up

VB

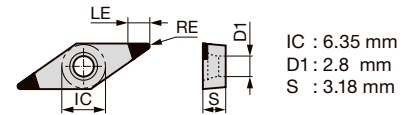

35° Rhombic with hole, Positive 5°

Application		Dimension (mm)		No. of corners	Wiper	Standard	Problem															S	H	Sintered metal									
		RE	LE				Burr	Finak wear	Crater wear	Chipping	BXA10	BXA20	BR35F	BXM10	BXM20	BXA30	BXA40	BX310	BX330	BX360	BX930												
Precision finishing	2QP-VBGW110302-LF	0.2	3.5	2			O					●	●●																				
	2QP-VBGW110302-L		3.5	2									●	●																			
	2QP-VBGW110304-LF	0.4	3.1	2			O					●	●																				
	2QP-VBGW110304-L		3.1	2									●	●																			
	2QP-VBGW110308-LF	0.8	2.2	2			O					●	●																				
	2QP-VBGW110308-L		2.2	2									●	●																			
Finishing	2QP-VBGW110301	0.1	3.7	2		O					●	●																					
	2QP-VBGW110302	0.2	3.5	2		O					●	●																					
	2QP-VBGW110302-LC		3.5	2						O		●	●																				
	2QP-VBGW110304	0.4	3.1	2		O					●	●		●	●	●	●																
	2QP-VBGW110304SR		3.1	2		O						●	●																				
	2QP-VBMW110304		3.1	2		O						●	●			●	●	●	●														
	2QP-VBGW110304-LC		3.1	2							O	●	●																				
	2QP-VBGW110308	0.8	2.2	2		O					●	●		●	●	●	●																
	2QP-VBGW110308SR		2.2	2		O						●	●																				
	2QP-VBMW110308		2.2	2		O						●	●			●	●	●	●														
2QP-VBGW110308-LC	2.2		2							O	●	●																					

● : Line up

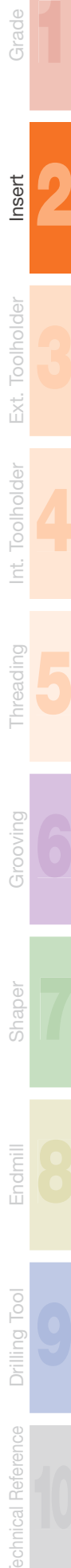

CBN Insert NEGATIVE TYPE

- : Continuous cutting
- ◐ : Light interrupted cutting
- ✶ : Heavy interrupted cutting

VB with chipbreaker

35° Rhombic with hole, Positive 5°

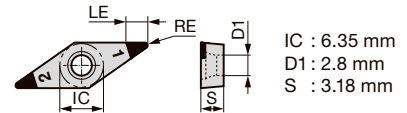

IC : 6.35 mm
D1 : 2.8 mm
S : 3.18 mm

Application	Designation	Dimension (mm)				Standard	Problem				Material												
		RE	LE	No. of corners	Wiper		Burr	Finak wear	Crater wear	Chipping	BXA10	BXA20	BXM10										
Precision finishing	2QP-VBGT110304-HP	0.4	3	2		○					●	●●	●										
	2QP-VBGT110304-HS		3	2	○						●	●●											
	2QP-VBGT110308-HP	0.8	2.2	2		○					●	●	●										
	2QP-VBGT110308-HS		2.2	2	○						●	●											

● : Line up

VB

35° Rhombic with hole, Positive 5°

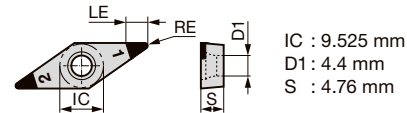

IC : 9.525 mm
D1 : 4.4 mm
S : 4.76 mm

Application	Designation	Dimension (mm)				Standard	Problem				Material															
		RE	LE	No. of corners	Wiper		Burr	Finak wear	Crater wear	Chipping	BXA10	BXA20	BR35F	BXM10	BXM20	BXA30	BXA40	BX310	BX330	BX360						
Precision finishing	2QP-VBGW160402-LF	0.2	3.5	2		○					●	●														
	2QP-VBGW160402-L		3.5	2	○						●	●														
	2QP-VBGW160404-LF	0.4	3.1	2		○					●	●														
	2QP-VBGW160404-L		3.1	2	○						●	●														
	2QP-VBGW160408-LF	0.8	2.2	2		○					●	●														
	2QP-VBGW160408-L		2.2	2	○						●	●														
Finishing	2QP-VBGW160402	0.2	3.5	2		○					●	●														
	2QP-VBGW160402-LC		3.5	2				○			●	●														
	2QP-VBGW160404	0.4	3.1	2		○					●	●			●	●	●	●								
	2QP-VBGW160404SR		3.1	2	○							●														
	2QP-VBMW160404		3.1	2	○							●						●	●	●						
	2QP-VBGW160404-LC	3.1	2					○			●	●														
	2QP-VBGW160408	0.8	2.2	2		○					●	●			●	●	●	●								
	2QP-VBGW160408SR		2.2	2	○							●														
	2QP-VBMW160408		2.2	2	○							●							●	●	●					
	2QP-VBGW160408-LC		2.2	2					○			●	●													
	2QP-VBGW160412		1.2	3	2		○					●	●													
Medium cutting	2QP-VBGW160402-H	0.2	3.5	2					○		●															
	2QP-VBGW160404-H	0.4	3.1	2					○		●															
	2QP-VBGW160404HC		3.1	2					○		●															
	2QP-VBGW160408-H	0.8	2.2	2					○		●															
	2QP-VBGW160408HC		2.2	2					○		●															

● : Line up

Reference pages: External toolholder → 3-51 -, Internal toolholder → 4-27

VB with chipbreaker

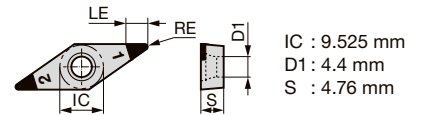

35° Rhombic with hole, Positive 5°

Application	Designation	Dimension (mm)		No. of corners	Wiper	Standard	Problem				Material							
		RE	LE				Burr	Finak wear	Crater wear	Chipping	BXA10	BXA20	BXM10					
Precision finishing	2QP-VBGT160404-HP	0.4	3	2		○					●	●●	●					
	2QP-VBGT160404-HS		3	2		○						●	●●	●				
	2QP-VBGT160408-HP	0.8	2.2	2		○					●	●●	●					
	2QP-VBGT160408-HS		2.2	2		○						●	●●	●				

● : Line up

VC

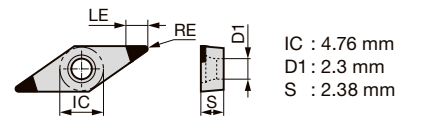

35° Rhombic with hole, Positive 7°

Application	Designation	Dimension (mm)		No. of corners	Wiper	Standard	Problem				Material							
		RE	LE				Burr	Finak wear	Crater wear	Chipping	BXA10	BXA20						
Finishing	2QP-VCGW080202	0.2	3.5	2		○					●	●●						
	2QP-VCGW080204	0.4	3.1	2		○					●	●●						
	2QP-VCGW080208	0.8	2.2	2		○					●	●●						

● : Line up

VC

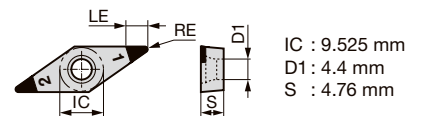

35° Rhombic with hole, Positive 7°

Application	Designation	Dimension (mm)		No. of corners	Wiper	Standard	Problem				Material												
		RE	LE				Burr	Finak wear	Crater wear	Chipping	BXA10	BXA20	BXM10	BXM20	BXA40	BX330	BX360	BX815	BX930				
Precision finishing	2QP-VCGW160408-E	0.8	2.2	2		○						●	●●	●	●●	●							
	2QP-VCGW160408-LT		2.2	2									●	●●	●	●●	●						
	2QP-VCGW160412-E	1.2	3	2		○																	
	2QP-VCGW160412-LT		3	2																			
Finishing	2QP-VCGW160402	0.2	3.5	2		○						●	●●										
	2QP-VCGW160404	0.4	3.1	2		○						●	●●	●	●●	●							
	2QP-VCMW160404		3.1	2		○																	
	2QP-VCGW160408	0.8	2.2	2		○						●	●●										
Medium cutting	2QP-VCGW160402-H	0.2	3.5	2								●	●●										
	2QP-VCGW160404-H	0.4	3.1	2								●	●●										
	2QP-VCGW160408-H	0.8	2.2	2								●	●●										

● : Line up

Reference pages: VB: External toolholder → 3-51 -, Internal toolholder → 4-27
VC: External toolholder → 3-54 -, Internal toolholder → 4-16 -

CBN Insert POSITIVE TYPE

- : Continuous cutting
- ◐ : Light interrupted cutting
- ◑ : Heavy interrupted cutting

WX

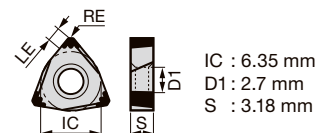

80° Trigon with hole

S	Superalloy																			
H	Hard material	●	◐	◑																
	Sintered metal																			

Application	Designation	Dimension (mm)		No. of corners	Wiper	Standard	Problem				BXA10	BXA20	BR35F																
		RE	LE				Burr	Flank wear	Crater wear	Chipping																			
Finishing	6QS-WXGQ040302SPR	0.2	1.8	6		○					●	●	●																
	6QS-WXGQ040302SPL		1.8	6		○					●	●	●																
	6QS-WXGQ040304SPR	0.4	1.8	6		○					●	●	●																
	6QS-WXGQ040304SPL		1.8	6		○					●	●	●																
	6QS-WXGQ040308SPR	0.8	1.7	6		○					●	●	●																
	6QS-WXGQ040308SPL		1.7	6		○					●	●	●																

● : Line up

WX with chipbreaker

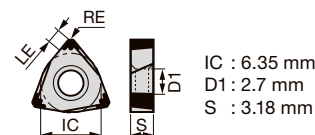

80° Trigon with hole

S	Superalloy																			
H	Hard material	●	◐	◑																
	Sintered metal																			

Application	Designation	Dimension (mm)		No. of corners	Wiper	Standard	Problem				BXA10	BXA20	BR35F															
		RE	LE				Burr	Flank wear	Crater wear	Chipping																		
Precision finishing	6QS-WXGU040304R-HP	0.4	1.8	6		○					●	●	●															
	6QS-WXGU040304L-HP		1.8	6		○					●	●	●															
	6QS-WXGU040308R-HP	0.8	1.7	6		○					●	●	●															
	6QS-WXGU040308L-HP		1.7	6		○					●	●	●															

● : Line up

Reference pages: External toolholder → **3-64** -, Internal toolholder → **4-28**

CBN Insert NEGATIVE TYPE

- : Continuous cutting
- ◐ : Light interrupted cutting
- ✱ : Heavy interrupted cutting

CN with chipbreaker

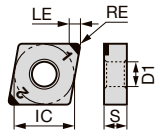

IC : 12.7 mm
D1 : 5.16 mm
S : 4.76 mm

80° Rhombic with hole

S	Superalloy	●	◐	✱	●	◐	◐											
H	Hard material	●	◐	✱	●	◐	◐											
	Sintered metal																	

Application	Designation	Dimension (mm)			Standard	Problem				BXA10	BXA20	BR35F	BXM10	BXM20	BXA40								
		RE	LE	No. of corners		Wiper	Burr	Flank wear	Crater wear												Chipping		
Precision finishing	2QP-CNGM120404-HP	0.4	2.3	2	○					●	●	●	●										
	4QS-CNGG120404-HP		1.6	4	○					●	●	●	●										
	2QP-CNGM120404-HS		2.3	2	○					●	●	●	●										
	4QS-CNGG120404-HS		1.6	4	○					●	●	●	●										
	2QP-CNGM120408-HP	0.8	2.2	2	○					●	●	●	●										
	4QS-CNGG120408-HP		1.5	4	○					●	●	●	●										
	2QP-CNGM120408FW-HP		2.2	2	○	○					●	●	●	●									
	4QS-CNGG120408FW-HP		1.8	4	○	○					●	●	●	●									
	2QP-CNGM120408-HS		2.2	2	○						●	●	●	●									
	4QS-CNGG120408-HS		1.8	4	○						●	●	●	●									
	2QP-CNGM120408FW-HS		2.2	2	○	○					●	●	●	●									
	4QS-CNGG120408FW-HS		1.8	4	○	○					●	●	●	●									
Medium cutting	2QP-CNGM120412-HP	1.2	2.4	2	○					●	●	●	●										
	2QP-CNGM120412-HS		2.4	2	○					●	●	●	●										
	4QS-CNGG120412-HS		2.2	4	○					●	●	●	●										
	2QP-CNGM120412FW-HS		2.4	2	○	○					●	●	●	●									
	2QP-CNGM120408-HF	0.8	2.2	2	○					●	●	●	●		●								
	4QS-CNGG120408-HF		1.8	4	○					●	●	●	●		●								
	4QP-CNGG120408-HF		2.2	4	○					●	●	●	●		●								
	2QP-CNGM120408-HM		2.2	2	○					●	●	●	●		●								
	4QS-CNGG120408-HM		1.5	4	○					●	●	●	●		●								
	4QP-CNGG120408-HM		2.2	4	○					●	●	●	●		●								
	2QP-CNGM120412-HF		2.4	2	○					●	●	●	●		●								
	4QS-CNGG120412-HF		2.2	4	○					●	●	●	●		●								
Medium cutting	4QP-CNGG120412-HF	1.2	2.4	4	○					●	●	●	●		●								
	2QP-CNGM120412-HM		2.4	2	○					●	●	●	●		●								
	4QS-CNGG120412-HM		1.7	4	○					●	●	●	●		●								
	4QP-CNGG120412-HM		2.4	4	○					●	●	●	●		●								

● : Line up

Reference pages: External toolholder → [3-81](#) -

Grade 1
Insert 2
Ext. Toolholder 3
Int. Toolholder 4
Threading 5
Grooving 6
Shaper 7
Endmill 8
Drilling Tool 9
Technical Reference 10

● : Continuous cutting
 ●● : Light interrupted cutting
 ✱ : Heavy interrupted cutting

CBN Insert NEGATIVE TYPE

DN with chipbreaker

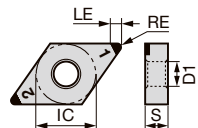

IC : 12.7 mm
 DT : 5.16 mm
 S : 4.76 mm

55° Rhombic with hole

S	Superalloy	●	●●	✱	●	●●	●●								
H	Hard material														
○	Sintered metal														

Application	Designation	Dimension (mm)			Standard	Problem																	
		RE	LE	No. of corners		Burr	Finak wear	Crater wear	Chipping	BXA10	BXA20	BR35F	BXM10	BXM20	BXA40								
Precision finishing	2QP-DNGM150404-HP	0.4	2.5	2	○					●	●●	✱	●	●●	●●								
	4QS-DNGG150404-HP		2	4	○						●	●●	✱										
	2QP-DNGM150404-HS	2.5	2	○						●	●●	✱											
	4QS-DNGG150404-HS	2	4	○						●	●●	✱											
	2QP-DNGM150408-HP	0.8	2.1	2	○					●	●●	✱		●									
	4QS-DNGG150408-HP		1.6	4	○						●	●●	✱										
	2QP-DNGM150408-HS	2.1	2	○						●	●●	✱											
	4QS-DNGG150408-HS	1.6	4	○						●	●●	✱											
	2QP-DNGM150412-HP	1.2	2	2	○					●	●●	✱											
4QS-DNGG150412-HP	2		4	○						●	●●	✱											
2QP-DNGM150412-HS	2	2	○						●	●●	✱												
4QS-DNGG150412-HS	1.6	4	○						●	●●	✱												
Medium cutting	2QP-DNGM150408-HF	0.8	2.1	2	○										●								
	4QS-DNGG150408-HF		2	4	○											●							
	4QP-DNGG150408-HF	2.1	4	○												●							
	2QP-DNGM150408-HM	2.1	2	○												●							
	4QS-DNGG150408-HM	1.6	4	○							●												
	4QP-DNGG150408-HM	2.1	4	○												●							
	2QP-DNGM150412-HF	1.2	2	2	○							●			●								
	4QS-DNGG150412-HF		2.6	4	○								●										
	4QP-DNGG150412-HF	2	4	○												●							
2QP-DNGM150412-HM	2	2	○												●								
4QP-DNGG150412-HM	2	4	○												●								

● : Line up

- Positive
- Negative
- CBN
- PCD
- C
- D
- E
- F
- G
- T
- V
- W
- Y
- OTHERS

DN

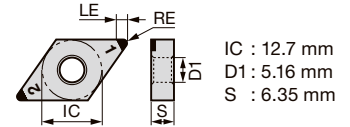

 **55° Rhombic with hole**

Application	Designation	Dimension (mm)				Standard	Problem					Material										
		RE	LE	No. of corners	Wiper		Burr	Finak wear	Crater wear	Chipping	BXA10		BXA20	BR35F	BXM10	BXM20						
																	S	H	S			
Precision finishing	2QP-DNGA150604-LF	0.4	2.5	2		○						●	●●	※	●	●●						
	2QP-DNGA150604-L		2.5	2			○						●	●								
	2QP-DNGA150608-LF	0.8	2.1	2		○						●	●									
	2QP-DNGA150608-L		2.1	2			○						●	●								
	2QP-DNGA150612-LF	1.2	2	2		○						●	●									
	2QP-DNGA150612-L		2	2			○						●	●								
Finishing	2QP-DNGA150604	0.4	2.5	2		○						●	●			●	●					
	2QP-DNGA150604SR		2.5	2		○								●								
	2QP-DNGA150604-LC		2.5	2					○			●	●									
	2QP-DNGA150608	0.8	2.1	2		○						●	●			●	●					
	2QP-DNGA150608SR		2.1	2		○								●								
	2QP-DNGA150608-LC		2.1	2					○			●	●									
	2QP-DNGA150612	1.2	2	2		○						●	●			●	●					
	2QP-DNGA150612SR		2	2		○								●								
	2QP-DNGA150612-LC		2	2					○			●	●									
	Medium cutting	2QP-DNGA150604-H	0.4	2.5	2						○		●	●								
2QP-DNGA150604HC		2.5		2						○				●								
2QP-DNGA150608-H		0.8	2.1	2						○		●	●									
2QP-DNGA150608HC			2.1	2						○				●								
2QP-DNGA150612-H		1.2	2	2						○		●	●									
2QP-DNGA150612HC			2	2						○				●								

● : Line up

DN with chipbreaker

 **55° Rhombic with hole**

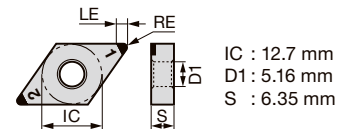

Application	Designation	Dimension (mm)				Standard	Problem					Material									
		RE	LE	No. of corners	Wiper		Burr	Finak wear	Crater wear	Chipping	BXA10		BXA20	BR35F	BXM10						
																S	H	S			
Precision finishing	2QP-DNGM150608-HP	0.8	2.1	2		○						●	●	●	●						
	2QP-DNGM150608-HS		2.1	2		○							●	●	●	●					

● : Line up

CBN Insert NEGATIVE TYPE

- : Continuous cutting
- ◐ : Light interrupted cutting
- ◑ : Heavy interrupted cutting

FN

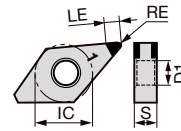

IC : 12.7 mm
D1 : 5.16 mm
S : 4.76 mm



45° Rhombic with hole

S Superalloy
H Hard material
Sintered metal

Application	Designation	Dimension (mm)		No. of corners	Wiper	Standard	Problem				BXA20	
		RE	LE				Burr	Finak wear	Crater wear	Chipping		
Precision finishing	2QP-FNGA150404-LF	0.4	2.6	2			○				●	
	2QP-FNGA150404-L		2.6	2			○				●	
	2QP-FNGA150408-LF	0.8	3	2			○				●	
	2QP-FNGA150408-L		3	2			○				●	
	2QP-FNGA150412-LF	1.2	3.3	2			○				●	
	2QP-FNGA150412-L		3.3	2			○				●	
Finishing	2QP-FNGA150402	0.2	2.8	2		○					●	
	2QP-FNGA150404	0.4	2.6	2		○					●	
	2QP-FNGA150404-LC		2.6	2				○			●	
	2QP-FNGA150408	0.8	3	2		○					●	
	2QP-FNGA150408-LC		3	2				○			●	
	2QP-FNGA150412	1.2	3.3	2		○					●	
	2QP-FNGA150412-LC		3.3	2					○		●	
	Medium cutting	2QP-FNGA150404-H	0.4	2.6	2					○		●
		2QP-FNGA150408-H	0.8	3	2					○		●
		2QP-FNGA150412-H	1.2	3.3	2					○		●

● : Line up

FN with chipbreaker

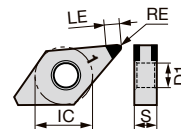

IC : 12.7 mm
D1 : 5.16 mm
S : 4.76 mm



45° Rhombic with hole

S Superalloy
H Hard material
Sintered metal

Application	Designation	Dimension (mm)		No. of corners	Wiper	Standard	Problem				BXA20
		RE	LE				Burr	Finak wear	Crater wear	Chipping	
Precision finishing	2QP-FNGG150404-HP	0.4	2.6	2		○					●
	2QP-FNGG150408-HP	0.8	3	2		○					●
	2QP-FNGG150412-HP	1.2	3.3	2		○					●

● : Line up

Reference pages: External toolholder → **3-83 -**

FN

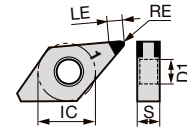

IC : 12.7 mm
 D1 : 5.16 mm
 S : 6.35 mm

45° Rhombic with hole

S Superalloy	
H Hard material	●●
Sintered metal	

Application	Designation	Dimension (mm)		No. of corners	Wiper	Standard	Problem				BXA20
		RE	LE				Burr	Finak wear	Crater wear	Chipping	
Precision finishing	2QP-FNGA150604-LF	0.4	2.6	2			○				●●
	2QP-FNGA150604-L		2.6	2			○				●●
	2QP-FNGA150608-LF	0.8	3	2			○				●●
	2QP-FNGA150608-L		3	2			○				●●
	2QP-FNGA150612-LF	1.2	3.3	2			○		○		●●
	2QP-FNGA150612-L		3.3	2			○		○		●●
Finishing	2QP-FNGA150604	0.4	2.6	2		○					●●
	2QP-FNGA150604-LC		2.6	2					○		●●
	2QP-FNGA150608	0.8	3	2		○					●●
	2QP-FNGA150608-LC		3	2					○		●●
	2QP-FNGA150612	1.2	3.3	2		○					●●
	2QP-FNGA150612-LC		3.3	2					○		●●
Medium cutting	2QP-FNGA150604-H	0.4	2.6	2						○	●●
	2QP-FNGA150608-H	0.8	3	2						○	●●
	2QP-FNGA150612-H	1.2	3.3	2						○	●●

● : Line up

FN with chipbreaker

45° Rhombic with hole

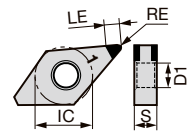

IC : 12.7 mm
 D1 : 5.16 mm
 S : 6.35 mm

S Superalloy	
H Hard material	●●
Sintered metal	

Application	Designation	Dimension (mm)		No. of corners	Wiper	Standard	Problem				BXA20
		RE	LE				Burr	Finak wear	Crater wear	Chipping	
Precision finishing	2QP-FNGG150604-HP	0.4	2.6	2		○					●●
	2QP-FNGG150608-HP	0.8	3	2		○					●●
	2QP-FNGG150612-HP	1.2	3.3	2		○					●●

● : Line up

CBN Insert NEGATIVE TYPE

- : Continuous cutting
- ◐ : Light interrupted cutting
- ✱ : Heavy interrupted cutting

GN

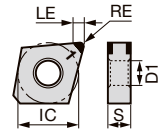

IC : 12.7 mm
D1 : 5.16 mm
S : 4.76 mm



70° Rhombic with hole

S	Superalloy										
H	Hard material	●	◐	✱	◐	◐					
	Sintered metal										

Application	Designation	Dimension (mm)			Wiper	Standard	Problem				BXA10	BXA20	BR35F	BXM20	BX360	BX470	BX930
		RE	LE	No. of corners			Burr	Flak wear	Crater wear	Chipping							
Precision finishing	2QP-GNGA120402-LF	0.2	2.2	2			○				●	●					
	2QP-GNGA120402-L		2.2	2			○				●	●					
	2QP-GNGA120404-LF	0.4	2.1	2			○				●	●					
	2QP-GNGA120404-L		2.1	2			○				●	●					
	2QP-GNGA120408-LF	0.8	2.1	2			○				●	●					
	2QP-GNGA120408-L		2.1	2			○		○		●	●					
	2QP-GNGA120412-LF	1.2	2.2	2			○				●	●					
2QP-GNGA120412-L	2.2		2			○		○		●	●						
Finishing	2QP-GNGA120402	0.2	2.2	2		○					●	●					
	2QP-GNGA120402-LC		2.2	2				○			●	●					
	2QP-GNGA120404	0.4	2.1	2		○					●	●	●	●			
	2QP-GNGA120404SR		2.1	2		○				○		●					
	2QP-GNGA120404-LC	2.1	2					○			●	●					
	2QP-GNGA120408	0.8	2.1	2		○					●	●	●	●	●	●	
	2QP-GNGA120408SR		2.1	2		○						●					
	2QP-GNGA120408-LC	2.1	2						○		●	●					
	2QP-GNGA120412	1.2	2.2	2		○					●	●	●	●	●	●	
	2QP-GNGA120412SR		2.2	2		○						●					
2QP-GNGA120412-LC	2.2	2						○		●	●						
Medium cutting	2QP-GNGA120404-H	0.4	2.1	2					○		●	●					
	2QP-GNGA120404HC		2.1	2					○		●		●				
	2QP-GNGA120408-H	0.8	2.1	2					○		●	●					
	2QP-GNGA120408HC		2.1	2					○		●		●				
	2QP-GNGA120412-H	1.2	2.2	2					○		●	●					
	2QP-GNGA120412HC		2.2	2					○		●		●				

● : Line up

GN with chipbreaker

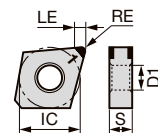

IC : 12.7 mm
D1 : 5.16 mm
S : 4.76 mm



70° Rhombic with hole

S	Superalloy										
H	Hard material	●	◐	●							
	Sintered metal										

Application	Designation	Dimension (mm)			Wiper	Standard	Problem				BXA10	BXA20	BXM10
		RE	LE	No. of corners			Burr	Flak wear	Crater wear	Chipping			
Precision finishing	2QP-GNGG120404-HP	0.4	2.1	2		○					●	●	●
	2QP-GNGG120404-HS		2.1	2		○					●	●	●
	2QP-GNGG120408-HP	0.8	2.1	2		○					●	●	●
	2QP-GNGG120408-HS		2.1	2		○					●	●	●
	2QP-GNGG120412-HP	1.2	2.2	2		○					●	●	●
	2QP-GNGG120412-HS		2.2	2		○					●	●	●

● : Line up

Reference pages: External toolholder → [3-82](#)

CBN Insert NEGATIVE TYPE

- : Continuous cutting
- ◐ : Light interrupted cutting
- * : Heavy interrupted cutting

TN

 **Triangular with hole**

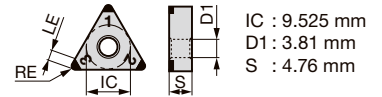

IC : 9.525 mm
D1 : 3.81 mm
S : 4.76 mm

S	Superalloy
H	Hard material
	Sintered metal

Application	Designation	Dimension (mm)			Wiper	Standard	Problem																					
		RE	LE	No. of corners			Burr	Finak wear	Crater wear	Chipping	BXA10	BXA20	BR35F	BXM10	BXM20	BXC50	BXA30	BXA40	BX310	BX330	BX360	BX380	BX470	BX480	BX815	BX930		
Precision finishing	3QP-TNGA160402-LF	0.2	2.3	3			○				●	●																
	3QP-TNGA160402-L		2.3	3				○				●	●															
	3QP-TNGA160404F	0.4	2.2	3			○				●	●												●				
	3QP-TNGA160404-LF		2.2	3			○					●	●															
	6QS-TNGA160404-LF		1.9	6			○					●	●															
	3QP-TNGA160404-L		2.2	3					○			●	●		●	●									●			
	3QP-TNGA160404WG	2.4	3		○	○						●	●			●												
	3QP-TNGA160408F	0.8	1.9	3			○																	●				
	3QP-TNGA160408-E		1.9	3			○																			●		
	3QP-TNGA160408-LT		1.9	3							○																●	
	3QP-TNGA160408-LF		1.9	3				○					●	●														
	6QS-TNGA160408-LF	1.6	6				○					●	●															
	3QP-TNGA160408-L	1.9	3						○			●	●		●	●								●				
	3QP-TNGA160408WG	2.2	3		○	○						●	●		●	●												
	3QP-TNGA160412-LF	1.2	2.4	3			○					●	●															
	6QS-TNGA160412-LF		1.8	6			○					●	●															
3QP-TNGA160412-L	2.4		3					○				●	●		●	●							●					
Finishing	3QP-TNGA160402	0.2	2.3	3			○					●	●															
	3QP-TNGA160402-LC		2.3	3					○				●	●														
	3QP-TNGA160404	0.4	2.2	3			○					●	●		●	●						●	●	●	●	●	●	
	T3QP-TNGA160404		2.2	3			○																				●	
	3QP-TNGA160404SR		2.2	3			○																					
	6QS-TNGA160404		1.9	6			○						●	●														
	6QS-TNGA160404SR		1.9	6			○																					
	6QP-TNGA160404		2.2	6			○											●	●	●								
	3QP-TNGA160404-LC		2.2	3						○			●	●														
	6QS-TNGA160404-LC		1.9	6						○			●	●														

T at the beginning of the designation means 10 pieces per package. Please see page L025 about the toolholders recommended for wiper inserts of the designation with WG at the end.

● : Line up

Grade 1
 Insert 2
 Ext. Toolholder 3
 Int. Toolholder 4
 Threading 5
 Grooving 6
 Shaper 7
 Endmill 8
 Drilling Tool 9
 Technical Reference 10

- : Continuous cutting
- ◐ : Light interrupted cutting
- ◑ : Heavy interrupted cutting

TN with chipbreaker

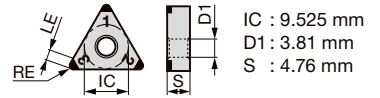

Triangular with hole

S	Superalloy	●	◐	◑																		
H	Hard material	●	◐	◑																		
	Sintered metal	●	◐	◑																		

Application	Designation	Dimension (mm)				Problem																				
		RE	LE	No. of corners	Wiper	Standard	Burr	Finak wear	Crater wear	Chipping	BXA10	BXA20	BR35F	BXM10	BXM20	BXA40										
Precision finishing	3QP-TNGM160404-HP	0.4	2.2	3		○					●	●	●	●												
	6QS-TNGG160404-HP		1.9	6		○					●	●	●													
	3QP-TNGM160404-HS		2.2	3		○					●	●	●													
	6QS-TNGG160404-HS		1.9	6		○					●	●	●													
	3QP-TNGM160408-HP	0.8	1.9	3		○					●	●	●	●												
	6QS-TNGG160408-HP		1.6	6		○					●	●	●													
	3QP-TNGM160408-HS		1.9	3		○					●	●	●													
	6QS-TNGG160408-HS		1.6	6		○					●	●	●													
	3QP-TNGM160412-HP	1.2	2.4	3		○					●	●	●													
	6QS-TNGG160412-HP		1.8	6		○					●	●	●													
	3QP-TNGM160412-HS		2.4	3		○					●	●	●													
	6QS-TNGG160412-HS		1.8	6		○					●	●	●													
Medium cutting	3QP-TNGM160408-HF	0.8	1.9	3		○					●				●											
	6QS-TNGG160408-HF		2.1	4		○					●															
	6QP-TNGG160408-HF		1.9	6		○										●										
	3QP-TNGM160408-HM		1.9	3		○										●										
	6QS-TNGG160408-HM		1.6	6		○						●														
	6QP-TNGG160408-HM		1.9	6		○										●										
	3QP-TNGM160412-HF	1.2	2.4	3		○						●				●										
	6QS-TNGG160412-HF		2.5	4		○						●														
	6QP-TNGG160412-HF		2.4	6		○											●									
	3QP-TNGM160412-HM		2.4	3		○											●									
	6QP-TNGG160412-HM		2.4	6		○											●									
	6QP-TNGG160412-HM		2.4	6		○											●									

● : Line up

Grade
Insert
Ext. Toolholder
Int. Toolholder
Threading
Grooving
Shaper
Endmill
Drilling Tool
Technical Reference

1
2
3
4
5
6
7
8
9
10

VN with chipbreaker



35° Rhombic with hole

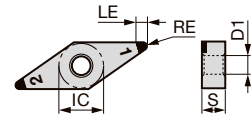

IC : 9.525 mm
 D1 : 3.81 mm
 S : 4.76 mm

Application	Designation	Dimension (mm)				Problem					Material							
		RE	LE	No. of corners	Wiper	Standard	Burr	Flank wear	Crater wear	Chipping	BXA10	BXA20	BXM10	BXM20	BXA40	S	H	Sintered metal
Precision finishing	2QP-VNGM160404-HP	0.4	3.1	2		○					●	●						
	4QS-VNGG160404-HP		2.6	4		○					●	●						
	2QP-VNGM160404-HS		3.1	2		○					●	●						
	4QS-VNGG160404-HS		2.6	4		○					●	●						
	2QP-VNGM160408-HP	0.8	2.2	2		○					●	●	●					
	4QS-VNGG160408-HP		1.7	4		○					●	●	●					
	2QP-VNGM160408-HS		2.2	2		○					●	●	●					
	4QS-VNGG160408-HS		1.7	4		○					●	●	●					
Medium cutting	2QP-VNGM160408-HF	0.8	2.2	2		○								●				
	4QP-VNGG160408-HF		2.2	4		○								●				
	2QP-VNGM160408-HM		2.2	2		○								●				
	4QS-VNGG160408-HM		1.7	4		○						●			●			
	4QP-VNGG160408-HM		2.2	4		○									●			
	4QP-VNGG160408-HM		2.2	4		○									●			

● : Line up

YN

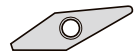

25° Rhombic with hole

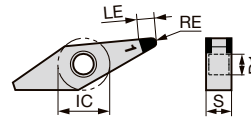

IC : 9.525 mm
 D1 : 3.81 mm
 S : 4.76 mm

Application	Designation	Dimension (mm)				Problem					Material						
		RE	LE	No. of corners	Wiper	Standard	Burr	Flank wear	Crater wear	Chipping	BXA20	S	H	Sintered metal			
															IC	LE	RE
Precision finishing	2QP-YNGA160404-LF	0.4	3.1	2		○					●						
	2QP-YNGA160404-L		3.1	2		○					●						
	2QP-YNGA160408-LF	0.8	3	2		○					●						
	2QP-YNGA160408-L		3	2		○					●						
Finishing	2QP-YNGA160402	0.2	3.5	2		○					●						
	2QP-YNGA160404	0.4	3.1	2		○					●						
	2QP-YNGA160404-LC		3.1	2		○					●						
	2QP-YNGA160408	0.8	3	2		○					●						
	2QP-YNGA160408-LC		3	2		○					●						

● : Line up

CBN Insert NEGATIVE TYPE

- : Continuous cutting
- ◐ : Light interrupted cutting
- ✱ : Heavy interrupted cutting

YN with chipbreaker

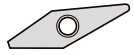

25° Rhombic with hole

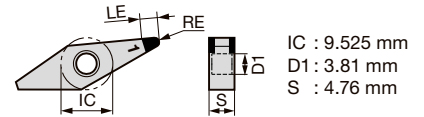

S Superalloy
H Hard material
●● Sintered metal

Application	Designation	Dimension (mm)		No. of corners	Wiper	Standard	Problem				BXA20	●	◐	✱	●	◐	✱	
		RE	LE				Burr	Flank wear	Crater wear	Chipping								
Precision finishing	2QP-YNGG160404-HP	0.4	3.1	2		○					●							
	2QP-YNGG160408-HP	0.8	3	2		○					●							

● : Line up

C

D

E

F

G

T

V

W

Y

OTHERS

CC

 **80° Rhombic Positive 7° with hole**

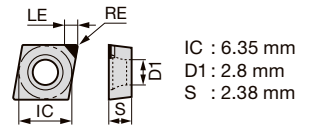

Application	Designation	Dimension (mm)		No. of corners	Chipbreaker															
		RE	LE			DX110	DX120	DX140												
Finishing	CCGW060200-DIA	0.05	2.4	1		●●	●●	●●												
	CCMT060202-DIA	0.2	2.4	1	○		●													
	CCGW060202-DIA		2.4	1				●												
	1QP-CCGT060204-NS	0.4	3.1	1	○	●														
	1QP-CCMT060204		2.4	1	○	●														
	CCMT060204-DIA		2.4	1	○		●													
CCGW060204-DIA	2.4		1				●													

● : Line up

CC

 **80° Rhombic Positive 7° with hole**

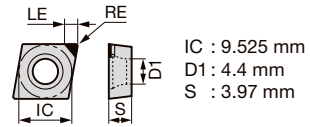

Application	Designation	Dimension (mm)		No. of corners	Chipbreaker															
		RE	LE			DX110	DX120	DX140	DX160											
Finishing	CCMT09T302-DIA	0.2	2.4	1	○		●													
	CCGW09T302-DIA		3.5	1				●												
	1QP-CCGT09T304-NS	0.4	3.1	1	○	●														
	1QP-CCMT09T304		2.4	1	○	●														
	CCMT09T304-DIA		2.4	1	○		●													
	CCGW09T304-DIA		3.5	1				●	●											
	1QP-CCGT09T308-NS	0.8	3	1	○	●														
	CCGW09T308-DIA		3.4	1				●												

● : Line up

CC

 **80° Rhombic Positive 7° with hole**

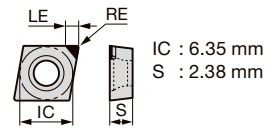

Application	Designation	Dimension (mm)		No. of corners	Chipbreaker															
		RE	LE			PD1	PD2													
Finishing	CCMT060201PBF	0.1	2.3	1	○		●													
	CCMT060202PBF	0.2	2.3	1	○		●													
	CCMT060204PBF	0.4	2.3	1	○		●													

● : Line up

PCD Insert POSITIVE TYPE

- : Continuous cutting
- ◐ : Light interrupted cutting
- ◑ : Heavy interrupted cutting

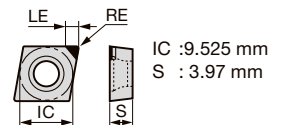
**CC**
**80° Rhombic
Positive 7°
with hole**
N Non-ferrous

◐ ◐

Application	Designation	Dimension (mm)			No. of corners	Chipbreaker	PD1	PD2																		
		RE	LE																							
Finishing	CCMT09T301PBF	0.1	2.3	1	○		●																			
	CCMT09T302PBF	0.2	2.3	1	○		●																			
	CCMT09T304PBF	0.4	2.3	1	○		●																			
	CCMT09T302PF	0.2	2.3	1				●																		
	CCMT09T304PF	0.4	2.3	1				●																		
	CCMW09T301	0.1	3.3	1			●																			
	CCMW09T302	0.2	3.3	1			●																			
	CCMW09T304	0.4	3.0	1			●																			
	CCMW09T308	0.8	3.0	1			●																			

● : Line up

CP
**80° Rhombic
Positive 11°
with hole**
N Non-ferrous

◐ ◐

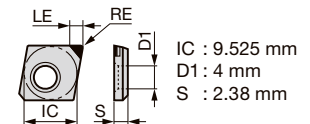

Application	Designation	Dimension (mm)			No. of corners	Chipbreaker	DX140																	
		RE	LE																					
Finishing	CPGA090202-DIA	0.2	2.4	1			●																	
	CPGA090204-DIA	0.4	2.4	1			●																	

Tungaloy's standard hole specification (ISO non-compliant)

● : Line up

DC
**55° Rhombic
Positive 7°
with hole**
N Non-ferrous

◐ ◐ ◐

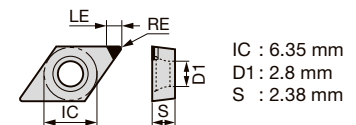

Application	Designation	Dimension (mm)			No. of corners	Chipbreaker	DX110	DX120	DX140																	
		RE	LE																							
Finishing	DCGW070200-DIA	0.05	2.4	1				●																		
	DCMT070202-DIA	0.2	2.3	1	○		●																			
	DCGW070202-DIA		2.3	1				●																		
	1QP-DCGT070204-NS	0.4	3	1	○		●																			
	DCMT070204-DIA		2.1	1	○			●																		
	DCGW070204-DIA		2.1	1					●																	

● : Line up

Reference pages: CC: External toolholder → 3-29 -, Internal toolholder → 4-12 -

CP: Internal toolholder → 4-14

DC: External toolholder → 3-37 -, Internal toolholder → 4-15 -

DC



**55° Rhombic
Positive 7°
with hole**

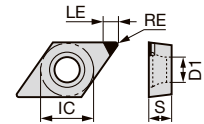

IC : 9.525 mm
D1 : 4.4 mm
S : 3.97 mm

Application	Designation	Dimension (mm)			No. of corners	Chipbreaker																		
		RE	LE																					
Finishing	DCMT11T302-DIA	0.2	3.2	1	○																			
	DCGW11T302-DIA		3.2	1	○																			
	1QP-DCGT11T304-NS	0.4	3	1	○	●																		
	DCMT11T304-DIA		3	1	○		●																	
	DCGW11T304-DIA		3	1	○			●																
	1QP-DCGT11T308-NS	0.8	3	1	○	●																		
	DCGW11T308-DIA		2.7	1	○			●																

● : Line up

DC



**55° Rhombic
Positive 7°
with hole**

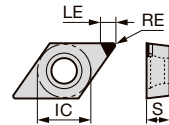

IC : 6.35 mm
S : 2.38 mm

Application	Designation	Dimension (mm)			No. of corners	Chipbreaker																	
		RE	LE																				
Finishing	DCMT070201PBF	0.1	2.3	1	○																		
	DCMT070202PBF	0.2	2.3	1	○																		
	DCMT070201PF	0.1	2.3	1	○																		
	DCMT070202PF	0.2	2.3	1	○																		

● : Line up

DC



**55° Rhombic
Positive 7°
with hole**

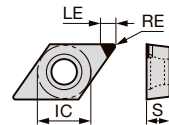

IC : 9.525 mm
S : 3.97 mm

Application	Designation	Dimension (mm)			No. of corners	Chipbreaker																	
		RE	LE																				
Finishing	DCMT11T301PBF	0.1	2.3	1	○																		
	DCMT11T302PBF	0.2	2.3	1	○																		
	DCMT11T304PBF	0.4	2.3	1	○																		
	DCMT11T302PF	0.2	2.3	1	○																		
	DCMT11T304PF	0.4	2.3	1	○																		
	DCMW11T301	0.1	4.3	1	○		●																
	DCMW11T302	0.2	4.3	1	○		●																
	DCMW11T304	0.4	4.0	1	○		●																
DCMW11T308	0.8	3.8	1	○		●																	

● : Line up

Reference pages: External toolholder → 3-37 -, Internal toolholder → 4-15 -

PCD Insert POSITIVE TYPE

- : Continuous cutting
- ◐ : Light interrupted cutting
- ✱ : Heavy interrupted cutting

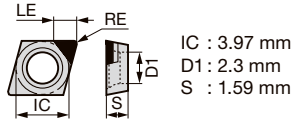
EP

**75° Rhombic
Positive 11°
with hole**

N Non-ferrous

●●

Application	Designation	Dimension (mm)		No. of corners	Chipbreaker	DX140														
		RE	LE																	
Finishing	EPGW040102-DIA	0.2	2	1		●														
	EPGW040104-DIA	0.4	1.9	1		●														

● : Line up

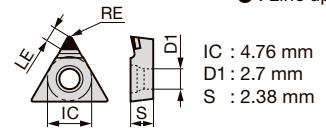
TC

**Triangular
Positive 7°
with hole**

N Non-ferrous

●●

Application	Designation	Dimension (mm)		No. of corners	Chipbreaker	DX120														
		RE	LE																	
Finishing	TCMT080202-DIA	0.2	2.2	1	○	●														
	TCMT080204-DIA	0.4	2	1	○	●														

● : Line up

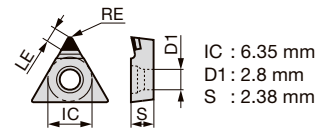
TC

**Triangular
Positive 7°
with hole**

N Non-ferrous

●●

Application	Designation	Dimension (mm)		No. of corners	Chipbreaker	DX120														
		RE	LE																	
Finishing	TCMT110202-DIA	0.2	2.4	1	○	●														
	TCMT110204-DIA	0.4	2.2	1	○	●														

● : Line up

Reference pages: EP: Internal toolholder → 4-9 -

TC: External toolholder → 3-63, Internal toolholder → 4-21 -

TC



Triangular Positive 7° with hole

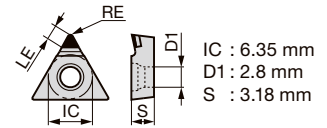

Application	Designation	Dimension (mm)		No. of corners	Chipbreaker																	
		RE	LE			N Non-ferrous ● ●																
Finishing	TCMT110302-DIA	0.2	2.4	1	○	●	●															
	1QP-TCMT110304	0.4	2.2	1	○	●																
	TCMT110304-DIA		2.2	1	○	●																

TP



Triangular Positive 11° with hole

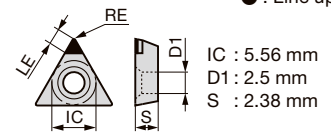

Application	Designation	Dimension (mm)		No. of corners	Chipbreaker																	
		RE	LE			N Non-ferrous ● ●																
Finishing	TPGA090202-DIA	0.2	2.4	1	○	●																
	TPGA090204-DIA	0.4	2.2	1	○	●																

Tungaloy's standard hole specification (ISO non-compliant)

TP



Triangular Positive 11° with hole

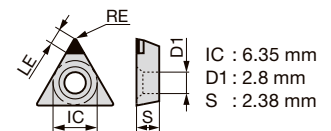

Application	Designation	Dimension (mm)		No. of corners	Chipbreaker																	
		RE	LE			N Non-ferrous ● ●																
Finishing	TPGA110202-DIA	0.2	2.4	1	○	●																
	TPGA110204-DIA	0.4	2.2	1	○	●																

Tungaloy's standard hole specification (ISO non-compliant)

PCD Insert POSITIVE TYPE

- : Continuous cutting
- : Light interrupted cutting
- : Heavy interrupted cutting

TP

**Triangular
Positive 11°
with hole**

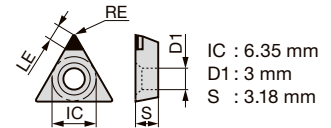

Application	Designation	Dimension (mm)		No. of corners	Chipbreaker	DX140														
		RE	LE																	
Finishing	TPGA110302-DIA	0.2	2.4	1		●●														
	TPGA110304-DIA	0.4	2.2	1		●●														
	TPGA110308-DIA	0.8	2.9	1		●●														

Tungaloy's standard hole specification (ISO non-compliant)

● : Line up

TP

**Triangular
Positive 11°
with hole**

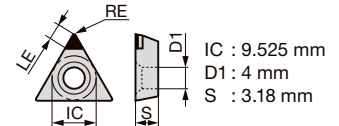

Application	Designation	Dimension (mm)		No. of corners	Chipbreaker	DX140															
		RE	LE																		
Finishing	TPGA160302-DIA	0.2	3.3	1		●●															
	TPGA160304-DIA	0.4	3.2	1		●●															
	TPGA160308-DIA	0.8	2.9	1		●●															

Tungaloy's standard hole specification (ISO non-compliant)

● : Line up

TP

**Triangular
Positive 11°
with hole**

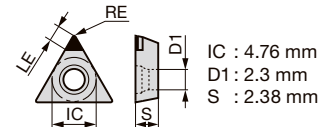

Application	Designation	Dimension (mm)		No. of corners	Chipbreaker	DX140															
		RE	LE																		
Finishing	TPGW080202-DIA	0.2	2.4	1		●●															
	TPGW080204-DIA	0.4	2.3	1		●●															

● : Line up

Reference pages: Internal toolholder → 4-22 -

TP



Triangular Positive 11° with hole

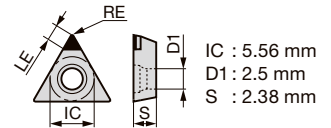

Application	Designation	Dimension (mm)		No. of corners	Chipbreaker	Material														
		RE	LE			N Non-ferrous	●	●												
Finishing	TPGW090202-DIA	0.2	2.4	1		●	●													
	TPGW090204-DIA	0.4	2.2	1			●													

● : Line up

TP



Triangular Positive 11° with hole

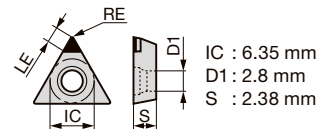

Application	Designation	Dimension (mm)		No. of corners	Chipbreaker	Material														
		RE	LE			N Non-ferrous	●	●												
Finishing	TPGW110202-DIA	0.2	2.4	1		●	●													
	TPGW110204-DIA	0.4	2.2	1			●													

● : Line up

TP



Triangular Positive 11° with hole

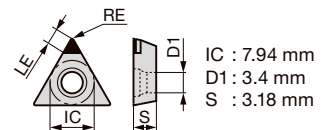

Application	Designation	Dimension (mm)		No. of corners	Chipbreaker	Material														
		RE	LE			N Non-ferrous	●	●												
Finishing	TPGW130302-DIA	0.2	3.3	1		●	●													
	TPGW130304-DIA	0.4	3.2	1			●													

● : Line up

Positive
Negative
CBN
PCD
C
D
E
F
G
T
V
W
Y
OTHERS

PCD Insert POSITIVE TYPE

- : Continuous cutting
- ◐ : Light interrupted cutting
- ✱ : Heavy interrupted cutting

TP



Triangular Positive 11° with hole

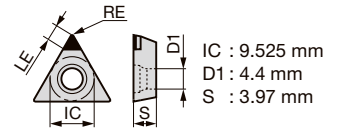

IC : 9.525 mm
D1 : 4.4 mm
S : 3.97 mm

Application	Designation	Dimension (mm)		No. of corners	Chipbreaker	Cutting Conditions	Material
		RE	LE				
Finishing	TPGW16T302-DIA	0.2	3.3	1	DX140	●	N Non-ferrous
	TPGW16T304-DIA	0.4	3.2	1		●	
	TPGW16T308-DIA	0.8	2.9	1		●	

● : Line up

TP



60° Rhombic Positive 11° with hole

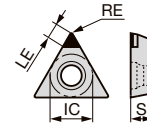

IC : 5.56 mm
S : 2.38mm

Application	Designation	Dimension (mm)		No. of corners	Chipbreaker	Cutting Conditions	Material
		RE	LE				
Finishing	TPMT090201PBF	0.1	2.3	1	PD1	●	N Non-ferrous
	TPMT090202PBF	0.2	2.3	1	PD2	●	
	TPMT090204PBF	0.4	2.3	1		●	
	TPMT090202PF	0.2	2.3	1		●	
	TPMT090204PF	0.4	2.3	1		●	

● : Line up

TP



60° Rhombic Positive 11° with hole

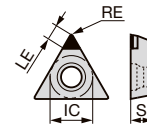

IC : 6.35 mm
S : 3.18mm

Application	Designation	Dimension (mm)		No. of corners	Chipbreaker	Cutting Conditions	Material
		RE	LE				
Finishing	TPMT110301PBF	0.1	2.3	1	PD1	●	N Non-ferrous
	TPMT110302PBF	0.2	2.3	1	PD2	●	
	TPMT110304PBF	0.4	2.3	1		●	
	TPMT110302PF	0.2	2.3	1		●	
	TPMT110304PF	0.4	2.3	1		●	

● : Line up

Reference pages: Internal toolholder → 4-22 -

VC

 **35° Rhombic Positive 7° with hole**

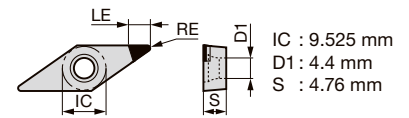

Application	Designation	Dimension (mm)		No. of corners	Chipbreaker	Material															
		RE	LE			1	2	3	4	5	6	7	8	9	10						
Finishing	VCMT160402-DIA	0.2	4.8	1	○	●	●	●													
	VCGW160402-DIA		4.8	1	○		●	●													
	1QP-VCGT160404-NS	0.4	3	1	○	●															
	VCMT160404-DIA		4.4	1	○		●	●													
	VCGW160404-DIA		4.4	1	○			●	●												
	1QP-VCGT160408-NS		0.8	3	1	○	●														

● : Line up

VC

 **35° Rhombic Positive 7° with hole**

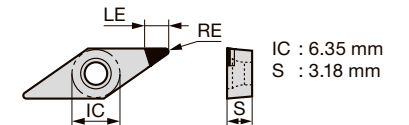

Application	Designation	Dimension (mm)		No. of corners	Chipbreaker	Material															
		RE	LE			1	2	3	4	5	6	7	8	9	10						
Finishing	VCMW110301	0.1	3.0	1		●															
	VCMW110302	0.2	3.3	1		●															
	VCMW110304	0.4	3.3	1		●															

● : Line up

VB

 **35° Rhombic Positive 5° with hole**

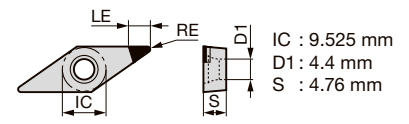

Application	Designation	Dimension (mm)		No. of corners	Chipbreaker	Material															
		RE	LE			1	2	3	4	5	6	7	8	9	10						
Finishing	1QP-VBGT160404-NS	0.4	3	1	○	●															
	1QP-VBGT160408-NS	0.8	3	1	○	●															

● : Line up

Positive

Negative

CBN

PCD

PCD Insert NEGATIVE TYPE

- : Continuous cutting
- ◐ : Light interrupted cutting
- ✱ : Heavy interrupted cutting

CN

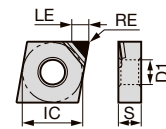
**80° Rhombic
with hole**IC : 12.7 mm
D1 : 5.16 mm
S : 4.76 mm

Application	Designation	Dimension (mm)		No. of corners	Chipbreaker	Material			Cutting Conditions																
		RE	LE			N	Non-ferrous	●	◐	✱	1	2	3	4	5	6	7	8	9	10	11	12			
Finishing	1QP-CNMM120402	0.2	2.8	1	○	●	●	●																	
	CNMM120402-DIA		3.5	1	○	●																			
	1QP-CNMM120404	0.4	2.8	1	○	●																			
	CNMM120404-DIA		3.5	1	○	●																			
	CNGA120404-DIA		3.5	1																					
	CNGA120408-DIA	0.8	2.8	1																					

● : Line up

CN

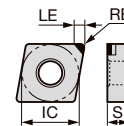
**80° Rhombic
with hole**IC : 12.7 mm
S : 4.76 mm

Application	Designation	Dimension (mm)		No. of corners	Chipbreaker	Material			Cutting Conditions																
		RE	LE			N	Non-ferrous	●	◐	✱	1	2	3	4	5	6	7	8	9	10	11	12			
Finishing	CNMX120404PF	0.4	3.4	1		●	●																		
	CNMX120408PF	0.8	3.4	1		●																			

● : Line up

DN

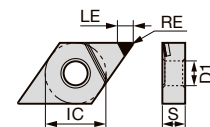
**55° Rhombic
with hole**IC : 12.7 mm
D1 : 5.16 mm
S : 4.76 mm

Application	Designation	Dimension (mm)		No. of corners	Chipbreaker	Material			Cutting Conditions																
		RE	LE			N	Non-ferrous	●	◐	✱	1	2	3	4	5	6	7	8	9	10	11	12			
Finishing	DNMM150402-DIA	0.2	3.3	1	○	●																			
	DNMM150404-DIA	0.4	3.1	1	○	●																			
	DNGA150404-DIA		3.1	1			●	●																	
	DNGA150408-DIA	0.8	2.8	1			●																		

● : Line up

Reference pages: CN: External toolholder → **3-81 -**
DN: External toolholder → **3-83 -**

DN

 **55° Rhombic with hole**

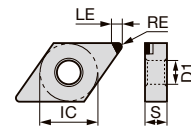

IC : 12.7 mm
 S : 4.76 mm

Application	Designation	Dimension (mm)		No. of corners	Chipbreaker															
		RE	LE			PD1	PD2													
		Finishing	DNMX150404PF			0.4	4.5	1		●	●									
	DNMX150408PF	0.8	4.5	1			●													

● : Line up

TN

 **Triangular with hole**

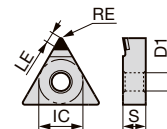

IC : 9.525 mm
 D1 : 3.81 mm
 S : 4.76 mm

Application	Designation	Dimension (mm)		No. of corners	Chipbreaker															
		RE	LE			DX110	DX120	DX140	DX160											
		Finishing	1QP-TNMM160402			0.2	2.7	1	○	●										
	TNMM160402-DIA		3.3	1	○		●													
	1QP-TNMM160404	0.4	2.6	1	○	●														
	TNMM160404-DIA		3.2	1	○		●													
	TNGA160404-DIA		3.2	1				●	●											
	TNGA160408-DIA	0.8	2.9	1				●	●											

● : Line up

TN

 **60° Rhombic with hole**

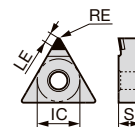

IC : 9.525 mm
 S : 4.76mm

Application	Designation	Dimension (mm)		No. of corners	Chipbreaker															
		RE	LE			PD1	PD2													
		Finishing	TNMX160404PF			0.4	3.0	1			●									
	TNMX160408PF	0.8	3.0	1			●													

● : Line up

Positive

Negative

CBN

PCD

C

D

E

F

G

T

V

W

Y

OTHERS

PCD Insert **NEGATIVE TYPE**

- : Continuous cutting
- ◐ : Light interrupted cutting
- ✱ : Heavy interrupted cutting

VN**35° Rhombic
with hole****N** Non-ferrous

●◐

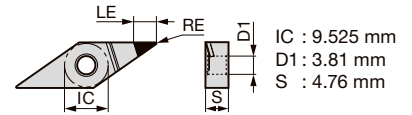

Application	Designation	Dimension (mm)		No. of corners	Chipbreaker	DX120														
		RE	LE																	
Finishing	VNMM160402-DIA	0.2	4.8	1	○	●														
	VNMM160404-DIA	0.4	4.4	1	○	●														
	VNMM160408-DIA	0.8	3.6	1	○	●														

● : Line up

3. External Toolholders



Main products

	<p>MINIFORCE MINI FTURN Economical double-sided inserts with excellent sharpness</p> 	<p>DXGU 3-66 - WXGU 3-64 - VXGU 3-70 -</p>
	<p>MINIFORCE MINI FTURN / J-SERIES Stepped-head off-set toolholder</p> 	<p>DC** 3-40 CC** 3-33 VB** 3-52 -</p>
	<p>MINIFORCE MINI FTURN / J-SERIES Round shank toolholder series</p>	<p>DC** 3-45 - DXGU 3-68 - VXGU 3-72 -</p>
	<p>MODUM INI TURN Interchangeable head toolholder</p> 	<p>DC** 3-37 - WXGU 3-64 DXGU 3-66 - VB** 3-51 - CC** 3-29 - VXGU 3-70 - Shank 3-120</p>
	<p>J-SERIES Back turning toolholder</p>	<p>3-98</p>
	<p>Y-axis holder Series  Solves chip evacuation problems using gravity</p>	<p>3-42 -</p>
	<p>TFX Series  Maximum depth of cut 5.0 mm</p>	<p>3-92 -</p>
	<p>DS-ACH Instantly adjust cutting edge height, reducing time</p>	<p>3-34 -</p>
	<p>TBP  High rigidity with vertically mounted inserts and screw clamps for back turning</p>	<p>3-101 -</p>

Quick Guide

CC** inserts

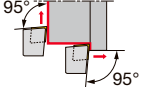
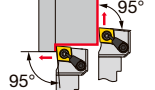
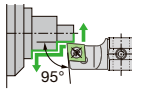
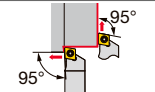
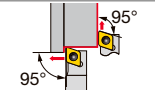
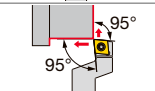
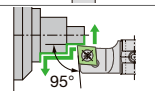
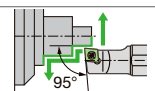
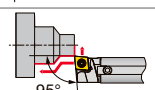
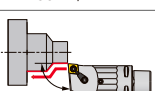

Cutting edge angle	Application	Designation	Insert	Square shank (height x width)													
				8 x 8	10 x 10	10 x 12	10 x 14	10 x 15	10 x 20	12 x 12	12 x 14	12 x 16	12 x 18	12 x 24	16 x 16	16 x 20	20 x 20
95°		QC-JSCL2CR-Y-CHP	CC**09								●		●			●	●
		QC-JSCL2CR-CHP	CC**06/09			●					●		●			●	●
		SCLCR/L-OH	CC**09			●	●					●				●	
		JSCL2CR/L SCLCR/L-N	CC**06/09	●	●						●					●	
		JTCL2CR/L	CC**06/09		●						●					●	
		JSCLCR-F15 SCLCR-F	CC**09					●	●			●	●	●		●	
		DS-SCLL-ACH	CC**09														
		DS-SCLL	CC**06/09														
		QR-SCLCL-CHP	CC**09														
		C3SCLCL-CHP	CC**09														

* When using stepped-head shank, the "Offset" will be "with".

	Cylindrical shank (shank dia.)									Tung Cap	Holder			Clamping style		Offset	Page
	ø14	ø15.875	ø16	ø19.05	ø20	ø22	ø25	ø25.4	ø32		C3	Modular head	Y-axis feed	Through-coolant	Screw-on		
											●	●	●	✓		without*	3-29
											●		●	✓		without*	3-29
													●	✓		with	3-30 3-31
														✓		without	3-30 3-32
														✓		without	3-32
														✓		with	3-33
			●	●	●	●	●	●						✓		-	3-34
	●	●	●	●	●	●	●	●						✓		-	3-35
		●	●	●							●		●	✓		-	3-36
									●			●	✓			-	3-36

Quick Guide

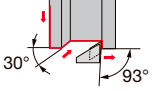
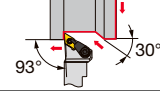
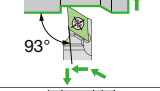
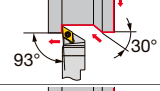
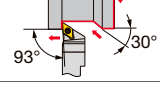
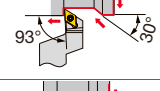
DC** inserts

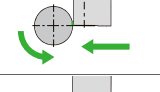
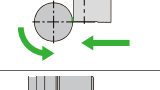
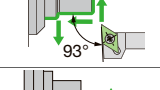
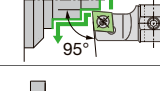
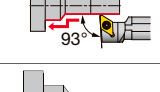
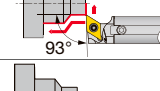
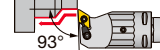

Cutting edge angle	Application	Designation	Insert	Square shank (height x width)														
				8 x 8	10 x 10	10 x 12	10 x 14	10 x 15	10 x 20	10 x 16	12 x 10	12 x 12	12 x 14	12 x 16	12 x 18	12 x 24		
93°		QC-JSDJ2CR-Y-CHP	DC**11									●		●				
		QC-JSDJ2CR-CHP	DC**07/11			●						●		●				
		SDJCR-OH	DC**11				●						●					
		JSDJ2CR/L SDJCR/L-N	DC**07/11	●	●								●					
		JTDJ2CR/L	DC**07/11		●								●					
		JSDJCR-F15 SDJCR-F	DC**07/11						●	●	●				●	●	●	
		JSDJCR/L	DC**07/11	●	●								●					
		Y-SDJCR-OH	DC**11										●					
		Y-SDJCR	DC**07/11		●								●					
		CH-SDUCL	DC**11		●								●					
		DS-SDUL-ACH	DC**11															
		JS-SDUCL DS-SDUL	DC**07/11															
		QR-SDUCL-CHP	DC**11															
		C3SDUCL-CHP	DC**11															

* When using stepped-head shank, the "Offset" will be "with".

	Cylindrical shank (shank dia.)				Tung Cap	Holder			Clamping style		Offset	Page									
	16 x 16	16 x 20	16 x 28	20 x 20		ø14	ø15.875	ø16	ø19.05	ø20			ø22	ø25	ø25.4	ø32	C3	Modular head	Y-axis feed	Through-coolant	Screw-on
●	●														●	●	●	✓		without*	3-37
●	●														●		●	✓		without*	3-37
●																	●	✓		with	3-38
●																		✓		without	3-39
●																			✓	without	3-40
	●	●																✓		with	3-40 3-41
●																		✓		with	3-41
●																●	●	✓		without	3-42
●																●		✓		without	3-43
●			●															✓		-	3-43
							●	●	●	●	●	●						✓		-	3-44
						●	●	●	●	●	●	●						✓		-	3-45
							●	●	●							●		✓		-	3-46
														●			✓		-	3-46	

Quick Guide

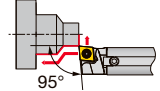
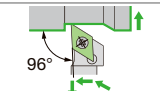
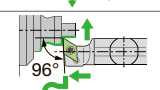
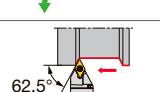
DC** inserts

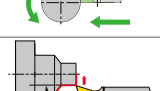
Cutting edge angle	Application	Designation	Insert	Square shank (height x width)																	
				8 x 8	10 x 10	10 x 12	10 x 14	10 x 15	10 x 20	10 x 16	12 x 10	12 x 12	12 x 14	12 x 16	12 x 18	12 x 24					
95°		QR-SDLCL-CHP	DC**11																		
96°		SDXCR-N	DC**11		●										●						
		DS-SDXL	DC**11																		
62.5°		JSDNCN SDNCN	DC**07/11	●	●										●						
		Y-SDNCR	DC**11												●						
107.5°		QR-SDQCL-CHP	DC**11																		

VB** inserts

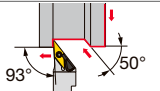
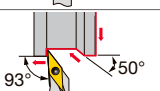
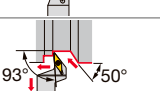
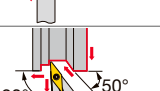
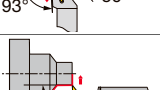
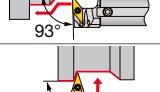
Cutting edge angle	Application	Designation	Insert	Square shank (height x width)					Cylindrical shank (shank dia.)			Holder		Clamping style		Offset	Page	
				10 x 10	12 x 12	12 x 16	16 x 16	16 x 20	ø16	ø19.05	ø20	Modular head	Through-coolant	Screw-on	Back-clamp			
93°		QC-JSVJ2BR-CHP	VB**11		●	●	●	●					●	●	✓		without*	3-51
		JSVJ2BR/L	VB**11	●	●		●								✓		without	3-51
		JSVJBR-F15	VB**11			●		●							✓		with	3-52
		JSVJBR/L	VB**11	●	●		●								✓		with	3-52
		QR-SVUBL-CHP	VB**11							●	●	●	●	●	✓		-	3-53
72.5°		JSVNBN	VB**11	●	●		●								✓		with	3-53

* When using stepped-head shank, the "Offset" will be "with".

	Cylindrical shank (shank dia.)				Tung Cap	Holder			Clamping style		Offset	Page									
	16 x 16	16 x 20	16 x 28	20 x 20		ø14	ø15.875	ø16	ø19.05	ø20			ø22	ø25	ø25.4	ø32	C3	Modular head	Y-axis feed	Through-coolant	Screw-on
							●	●	●						●		●	✓		-	3-47
	●																	✓		without	3-47
								●	●		●							✓		-	3-48
	●			●														✓		with	3-48 3-49
	●															●		✓		without	3-49
							●	●	●						●		●	✓		-	3-50

Quick Guide

VC** inserts

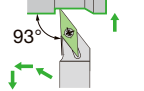
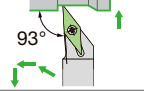
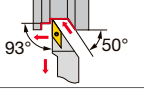
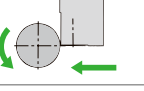
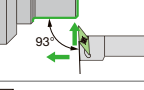
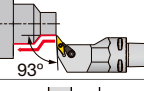
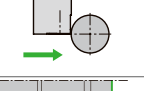
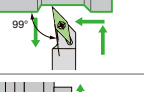
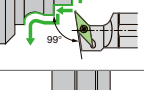
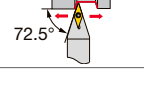
Cutting edge angle	Application	Designation	Insert	Square shank (height x width)							Cylindrical shank (shank dia.)						
				8 x 8	10 x 10	10 x 12	10 x 14	12 x 12	12 x 14	16 x 16	20 x 20	ø14	ø15.875	ø16	ø19.05	ø20	
93°		SVJCR-OH	VC**1103				●		●	●							
		SVJCR/L	VC**1103	●	●			●		●							
		SVJCR/L	VC**1604								●	●					
		Y-SVJCR-OH	VC**1103						●		●						
		CH-SVUCL	VC**1103		●				●		●	●					
		C3SVUCL-CHP	VC**1103														
95°		Y-SVXCL	VC**1103						●								
99°		SVXCR/L-N	VC**1103			●		●									
		DS-SVXL	VC**1103									●	●	●	●		
72.5°		SVVCN	VC**1103	●	●			●		●	●						

* When using stepped-head shank, the "Offset" will be "with".

	ø22	ø25	ø25.4	Tung Cap	Holder		Clamping style		Offset	Page
					Y-axis feed	Through-coolant	Screw-on	Back-clamp		
				C3		●	✓		without	3-54
							✓		without	3-54
							✓		with	3-55
					●	●	✓		without	3-55
							✓		-	3-56
				●	●		✓		-	3-56
					●		✓		without	3-57
							✓		without	3-57
	●	●	●				✓		-	3-58
							✓		with	3-58 3-59

Grade

1

Insert

2

Ext. Toolholder

3

Int. Toolholder

4

Threading

5

Grooving

6

Shaper

7

Endmill

8

Drilling Tool

9

Technical Reference

10

Quick Guide

VP** inserts

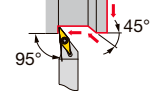
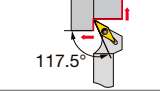
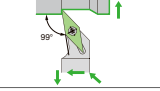
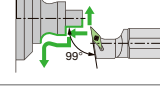
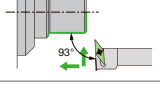
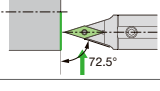
Cutting edge angle	Application	Designation	Insert	Square shank (height x width)				Cylindrical shank (shank dia.)					Clamping style		Offset	Page
				10 x 10	10 x 12	12 x 12	16 x 16	ø16	ø19.05	ø20	ø22	ø25.4	Screw-on	Back-clamp		
95°		JSVL2PR/L	VP**08/11	●		●	●						✓		without	3-60
117.5°		JSV2PR/L	VP**08/11	●		●	●						✓		without	3-60
99°		SVXPR/L	VP**11		●	●							✓		without	3-61
93°		DS-SVXP	VP**08						●	●	●	●	✓		-	3-61
93°		CH-SVUPL	VP**08	●		●							✓		-	3-62
72.5°		DS-SWPN-ACH	VP**11					●	●	●	●	●	✓		-	3-62

TC** inserts

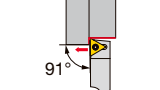
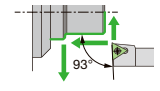
Cutting edge angle	Application	Designation	Insert	Square shank (height x width)					Clamping style		Offset	Page	
				8 x 8	8 x 10	10 x 10	12 x 12	16 x 16	Screw-on	Back-clamp			
91°		JSTACR/L	TC**08/11	●		●	●	●		✓		without	3-63
93°		CH-STUCL	TC**09			●	●			✓		-	3-63



WXGU inserts

Cutting edge angle	Application	Designation	Insert	Square shank (height x width)							Holder			Clamping style		Offset	Page	
				10 x 10	10 x 12	10 x 16	12 x 12	12 x 16	16 x 16	16 x 20	20 x 20	Modular head	Y-axis feed	Through-coolant	Screw-on			Back-clamp
95°		QC-JSWL2XR-Y-CHP	WXGU				●	●	●	●		●	●	●	✓		without*	3-64
		QC-JSWL2XR-CHP	WXGU		●		●	●	●	●		●		●	✓		without*	3-64
		JSWL2XR/L	WXGU	●			●		●		●				✓		without	3-65
		JPWL2XR/L	WXGU	●			●		●							✓	without	3-65

* When using stepped-head shank, the "Offset" will be "with".

Grade

Insert

Ext. Toolholder

Int. Toolholder

Threading

Grooving

Shaper

Endmill

Drilling Tool

Technical Reference

Quick Guide

DX*U inserts

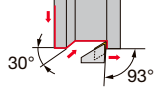
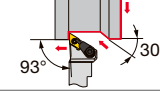
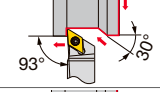
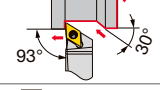
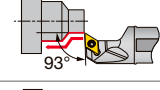
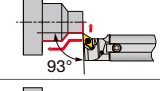
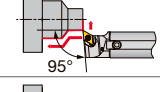
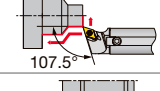
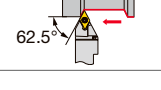
Cutting edge angle	Application	Designation	Insert	Square shank (height x width)						Cylindrical shank (shank dia.)							
				10 x 10	10 x 12	10 x 16	12 x 12	12 x 16	16 x 16	16 x 20	20 x 20	ø14	ø15.875	ø16	ø19.05	ø20	
		QC-JSDJ2XR-Y-CHP	DX*U				●	●	●	●							
		QC-JSDJ2XR-CHP	DX*U		●		●	●	●	●							
93°		JSDJ2XR/L	DX*U	●			●		●		●						
		JPDJ2XR/L	DX*U	●			●		●								
		JS-SDUXL	DX*U									●	●	●	●	●	
		QR-SDUXL-CHP	DX*U											●	●	●	
95°		QR-SDLXL-CHP	DX*U											●	●	●	
107.5°		QR-SDQXL-CHP	DX*U											●	●	●	
62.5°		QC-JSDNXR-CHP	DX*U		●		●	●	●	●							

* When using stepped-head shank, the "Offset" will be "with".

	ø22	ø25	ø25.4	Holder			Clamping style		Offset	Page
				Modular head	Y-axis feed	Through-coolant	Screw-on	Back-clamp		
				●	●	●	✓		without*	3-66
				●		●	✓		without*	3-66
							✓		without	3-67
								✓	without	3-67
	●	●	●				✓		-	3-68
				●		●	✓		-	3-68
				●		●	✓		-	3-68
				●		●	✓		-	3-69
				●		●	✓		with	3-70

Grade

1

Insert

2

Ext. Toolholder

3

Int. Toolholder

4

Threading

5

Grooving

6

Shaper

7

Endmill

8

Drilling Tool

9

Technical Reference

10

Quick Guide

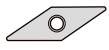

VXGU inserts

Cutting edge angle	Application	Designation	Insert	Square shank (height x width)						Cylindrical shank (shank dia.)					
				10 x 10	10 x 12	10 x 16	12 x 12	12 x 16	16 x 16	16 x 20	20 x 20	ø15.875	ø16	ø19.05	ø20
93°		QC-JSVJ2XR-CHP	VXGU		●		●	●	●	●					
		JSVJ2XR/L	VXGU	●			●		●		●				
		JPVJ2XR/L	VXGU	●			●		●						
		JS***-SVUXL	VXGU									●	●	●	●
117.5°		QR-SVUXL-CHP	VXGU									●	●	●	
		QR-SVQXL-CHP	VXGU									●	●	●	
72.5°		QC12-JSVVXR-CHP	VXGU		●		●	●	●	●					

* When using stepped-head shank, the "Offset" will be "with".

			Holder		Clamping style		Offset	Page
	ø25	ø25.4	Modular head	Through-coolant	Screw-on	Back-clamp		
			●	●	✓		without*	3-70
					✓		without	3-71
						✓	without	3-71
	●	●			✓		-	3-72
			●	●	✓		-	3-72
			●	●	✓		-	3-73
			●	●	✓		with	3-73

Grade

1

Insert

2

Ext. Toolholder

3

Int. Toolholder

4

Threading

5

Grooving

6

Shaper

7

Endmill

8

Drilling Tool

9

Technical Reference

10

Quick Guide



TN** inserts

Cutting edge angle	Application	Designation	Insert	Square shank (height x width)					Cylindrical shank (shank dia.)						Tung Cap	
				10 x 16	12 x 16	16 x 16	16 x 20	20 x 20	ø16	ø19.05	ø20	ø22	ø25	ø25.4		
95°		QC-PTL2NR-Y-CHP	TN**1604			●	●									
		QC-PTL2NR-CHP	TN**1604			●	●									
91°		JTTLNR/L	TN**1604		●	●										
		PTGNR/L	TN**1104/ 1604			●		●								
		PTGNR/L -CHP	TN**1104/ 1604					●								
100°		PTFNR/L	TN**1104/ 1604			●		●								
		PTXNR-N-OH	TN**1604	●	●	●										
		PTXNR-N	TN**1604	●	●	●		●								
		DS-PTXL-ACH	TN**1604						●	●	●	●	●	●		
93°		DS-PTXL	TN**1604						●	●	●	●		●		
		C3PTUNL	TN**1604													●
105°		ATQNR/L	TN**1604					●								

	Holder			Clamping style				Offset	Page
	Modular head	Y-axis feed	Through-coolant	Lever-lock	Back-clamp	Double-clamp	Screw-on		
	●	●	●	✓				without	3-74
	●		●	✓				without	3-74
					✓			without	3-75
				✓				with	3-75
			●	✓				with	3-76
				✓				with	3-76
			●	✓				without	3-77
				✓				without	3-78
				✓				-	3-79
				✓				-	3-79
			●	✓				-	3-80
						✓		with	3-80

Grade

1

Insert

2

Ext. Toolholder

3

Int. Toolholder

4

Threading

5

Grooving

6

Shaper

7

Endmill

8

Drilling Tool



9

Technical Reference

10

Quick Guide

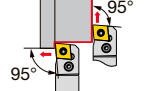
CN** inserts

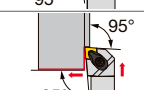
Cutting edge angle	Application	Designation	Insert	Square shank (height x width)			Holder	Clamping style			Offset	Page
				16 x 16	16 x 20	20 x 20		Through-coolant	Lever-lock	Double-clamp		
95°		PCL2NR PCLNR-N	CN**1204		●	●			✓		without	3-81
		PCLNR/L	CN**0904/ 1204	●		●			✓		with	3-82
		PCLNR/L-CHP	CN**0904/ 1204			●	●		✓		with	3-82

DN** inserts

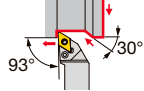
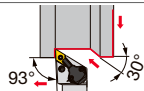
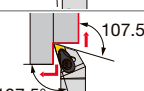
Cutting edge angle	Application	Designation	Insert	Square shank (height x width)			Holder	Clamping style		Offset	Page
				16 x 16	16 x 25	20 x 20		Through-coolant	Lever-lock		
93°		PDJNR/L	DN**1104/ 1504/1506	●		●			✓	with	3-83
		PDJNR/L-CHP	DN**1104/ 1504			●	●		✓	with	3-84
107.5°		ADQNR/L	DN**1104/ 1504/1506			●			✓	with	3-84

V/YN** inserts

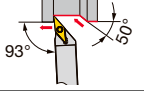
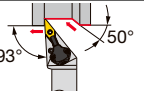
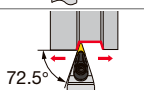
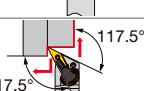
Cutting edge angle	Application	Designation	Insert	Square shank (height x width)			Holder	Clamping style			Offset	Page
				12 x 12	16 x 16	20 x 20		Through-coolant	Lever-lock	Back-clamp		
93°		JPVJ2NR/L	VN**1204	●	●				✓		without	3-85
		PVJNR/L-CHP	VN**1204 V/YN**1604			●	●		✓		with	3-85
72.5°		AVVNN	VN**1204 V/YN**1604			●				✓	with	3-86
117.5°		PVQNR/L-CHP	V/YN**1604			●	●		✓		with	3-86

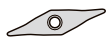

YWMT inserts

Cutting edge angle	Application	Designation	Insert	Square shank (height x width)		Clamping style		Offset	Page
				20 x 20		Screw-on	Back-clamp		
93°		SYJBR/L	YWMT16	●		✓		with	3-87
100°		SYHBR/L	YWMT16	●		✓		with	3-87
77.5°		SYIBN	YWMT16	●		✓		with	3-87
122.5°		SYQBR/L	YWMT16	●		✓		with	3-88



JV*N inserts

Cutting edge angle	Application	Designation	Insert	Square shank (height x width)				Clamping style		Offset	Page
				6 x 6	7 x 7	8 x 8	10 x 10	Screw-on	Back-clamp		
Front turning		JSXXR/L05	JVFN45R/L	●	●	●	●	✓		without	3-89

CSVF inserts

Cutting edge angle	Application	Designation	Insert	Square shank (height x width)					Clamping style		Offset	Page
				7 x 7	8 x 8	9.5 x 9.5	10 x 10	12 x 12	Screw-on	Back-clamp		
91°		CSVRL	CSVF	●	●	●	●	●	✓		with	3-90

CSVB inserts

Cutting edge angle	Application	Designation	Insert	Square shank (height x width)					Cutting edge effective length	Cutting depth maximum	Clamping style		Offset	Page
				7 x 7	8 x 8	9.5 x 9.5	10 x 10	12 x 12			Screw-on	Back-clamp		
Back turning		CSVRL	CSVB	●	●	●	●	●	0.7 mm - 1 mm	2 mm	✓		with	3-95

Grade

Insert

Ext. Toolholder

Int. Toolholder

Threading

Grooving

Shaper



Endmill

Drilling Tool

Technical Reference

Quick Guide

TF** inserts

Cutting edge angle	Application	Designation	Insert	Square shank (height x width)						Holder	Clamping style		Offset	Page	
				10 x 10	10 x 14	12 x 12	12 x 14	16 x 16	20 x 20		Through-coolant	Screw-on			Back-clamp
93°		TFTR-OH	TFX33/TF33		●		●	●		●		✓		with	3-92
		TFTR	TFX33/TF33	●		●		●	●			✓		without	3-93

TBP inserts

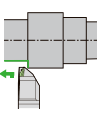
Cutting edge angle	Application	Designation	Insert	Square shank (height x width)						Cylindrical shank (shank dia.)			Holder			
				8 x 8	10 x 10	10 x 12	12 x 12	13 x 13	16 x 16	ø19.05	ø20	ø25.4	Y-axis feed	Through-coolant		
Back turning		TBPR-OH / OH2	TBP			●	●			●				●		
		TBPR/L	TBP	●	●		●			●						
		Y-TBPR-OH	TBP				●			●				●	●	
		Y-TBPR	TBP		●		●								●	
		DS-TBPL	TBP								●	●	●			

TBPA inserts

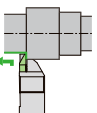
Cutting edge angle	Application	Designation	Insert	Square shank (height x width)				Holder	Cutting edge effective length	Cutting depth maximum	Clamping style		Offset	Page
				10 x 10	12 x 12	16 x 16	20 x 20				Through-coolant	Screw-on		
Back turning		TBPAR-OH	TBPA		●	●	●	●	4.5 mm - 6.3 mm	5.3 mm - 6.8 mm	✓		-	3-106
		CTPAR/L-OH / OH2	TBPA		●	●		●	4.5 mm - 6.3 mm	5.3 mm - 6.8 mm	✓		-	3-106 3-107
		CTPAR/L	TBPA	●	●	●	●		4.5 mm - 6.3 mm	5.3 mm - 6.8 mm	✓		-	3-107
		CH-TBPAL	TBPA			●	●			4.5 mm - 6.3 mm	5.3 mm - 6.8 mm	✓		-

	Cutting edge effective length	Cutting depth maximum	Clamping style		Offset	Page
			Screw-on	Back-clamp		
	3 mm - 4.8 mm	5.3 mm	✓		-	3-101 3-102
	3 mm - 4.8 mm	5.3 mm	✓		-	3-102
	3 mm - 4.8 mm	-	✓		-	3-103
	3 mm - 4.8 mm	-	✓		-	3-103
	3 mm - 4.8 mm	5.3 mm	✓		-	3-103

Grade

1

Insert

2

Ext. Toolholder

3

Int. Toolholder

4

Threading

5

Grooving

6

Shaper

7

Endmill

8

Drilling Tool

9

Technical Reference

10

Quick Guide



J10E inserts

Cutting edge angle	Application	Designation	Insert	Square shank (height x width)						Holder		Cutting edge effective length	Cutting depth maximum	Clamping style		Page
				10 x 10	10 x 12	12 x 12	12 x 16	16 x 16	16 x 20	Modular head	Through-coolant			Screw-on	Back-clamp	
Back turning		QC-JSEGR-CHP	J10ER		●	●	●	●	●	●	●	3 mm	3.3 mm	✓		3-98
		JSEGR/L	J10ER/L	●		●		●				3 mm	3.3 mm	✓		3-98

* When using stepped-head shank, the "Offset" will be "with".

TBVC inserts

Cutting edge angle	Application	Designation	Insert	Square shank (height x width)				Cutting edge effective length	Cutting depth maximum	Clamping style		Offset	Page
				10 x 10	12 x 12	16 x 16	20 x 20			Screw-on	Back-clamp		
Back turning		TBVCR-F	TBVC VC..1103..	●	●	●	●	7 mm	8.5 mm	✓		-	3-111

TBMH inserts

Cutting edge angle	Application	Designation	Insert	Square shank (height x width)						Cylindrical shank (shank dia.)									
				8 x 8	8 x 10	10 x 10	10 x 12	12 x 12	16 x 16	20 x 20	ø14	ø15.875	ø16	ø19.05	ø20	ø22			
Back turning		GTR-OH	TBMH				●	●	●										
		GTR	TBMH	●		●		●	●	●									
		Y-GTR-OH	TBMH					●	●										
		Y-GTR	TBMH			●		●											
		DS-GTTL	TBMH								●	●	●	●	●	●	●	●	●
		CH-GTTL	TBMH			●		●	●										

VC.. inserts

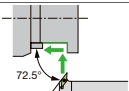
Cutting edge angle	Application	Designation	Insert	Square shank (height x width)		Cutting edge effective length	Cutting depth maximum	Clamping style		Offset	Page
				16 x 16	20 x 20			Screw-on	Back-clamp		
Back turning 		CH-SVXCL	VC..1103..	●	●	7 mm	7 mm	✓		-	3-112

TBDP inserts

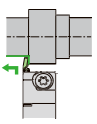
Cutting edge angle	Application	Designation	Insert	Square shank (height x width)				Holder	Cutting edge effective length	Cutting depth maximum	Clamping style			Offset	Page
				10 x 10	12 x 12	16 x 16	20 x 20				Clamp-on	Screw-on	Back-clamp		
Back turning 		TBDPR/L	TBDP	●	●	●	●		3.5 mm	3 mm - 5 mm	✓			-	3-110
		Y-TBDPR	TBDP		●			●	3.5 mm	5 mm	✓			-	3-110

	ø25	ø25.4	ø32	Holder		Cutting edge effective length	Cutting depth maximum	Clamping style		Offset	Page
				Y-axis feed	Through-coolant			Screw-on	Back-clamp		
				●		0.3 mm - 1.3 mm	1.6 mm	✓		-	3-113 3-114
						0.3 mm - 1.3 mm	1.6 mm - 2.7 mm	✓		-	3-115
				●	●	0.3 mm - 1.3 mm	1.6 mm	✓		-	3-116
				●		0.3 mm - 1.3 mm	1.6 mm	✓		-	3-116
	●	●	●			0.3 mm - 1.3 mm	1.6 mm	✓		-	3-117
						0.3 mm - 1.3 mm	1.5 mm	✓		-	3-117

TMV Chipbreaker

For front turning | Specially designed for vibration cutting on automatic lathes

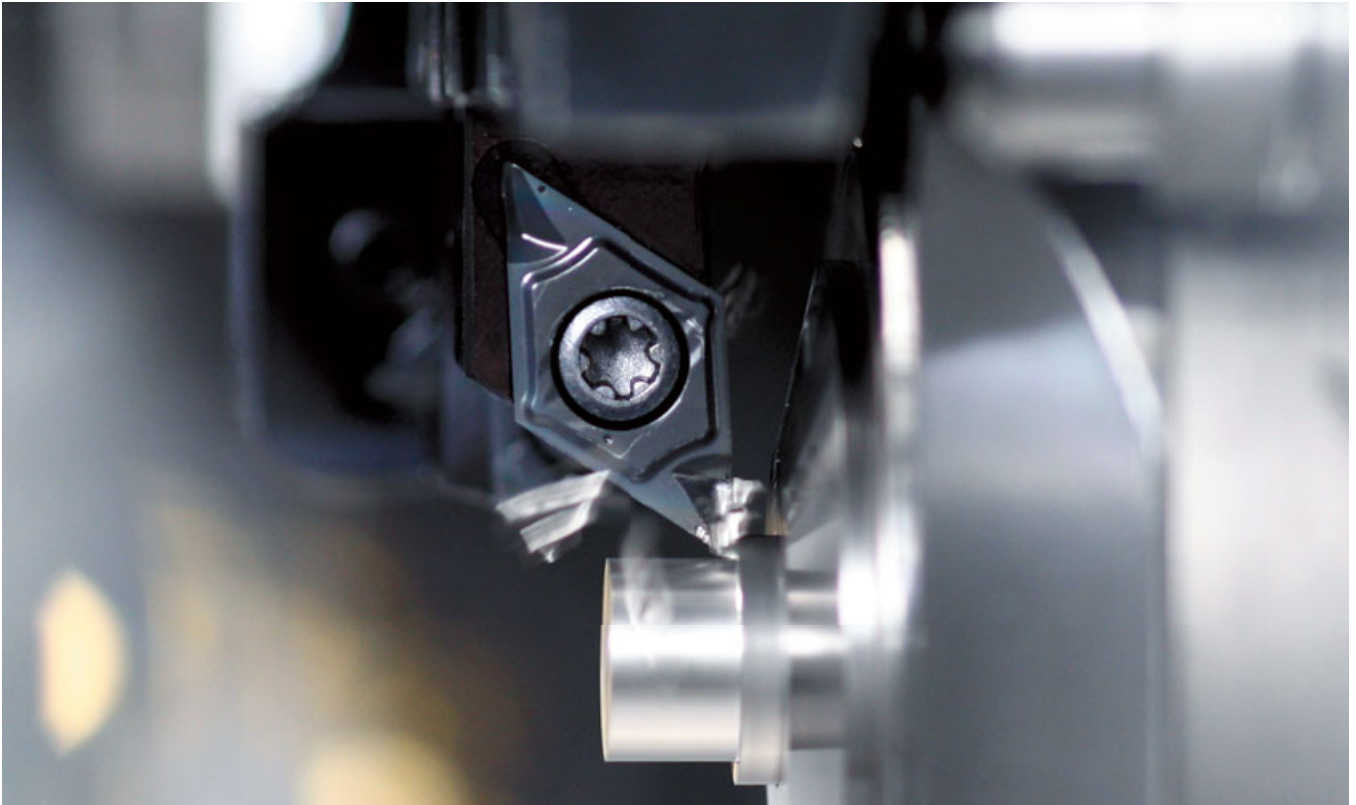

N°1 Chipbreaker for vibration machining

Reliably long tool life and stable chip evacuation during vibration cutting

Performance

- **Significantly reducing damage of cutting edge**
Extended lifespan can be expected even in the machining of difficult-to-cut materials
- **More stable of chip control**
Stable chip formation during vibration cutting

What is the unique point?

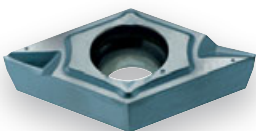

Controls chip flow reliably

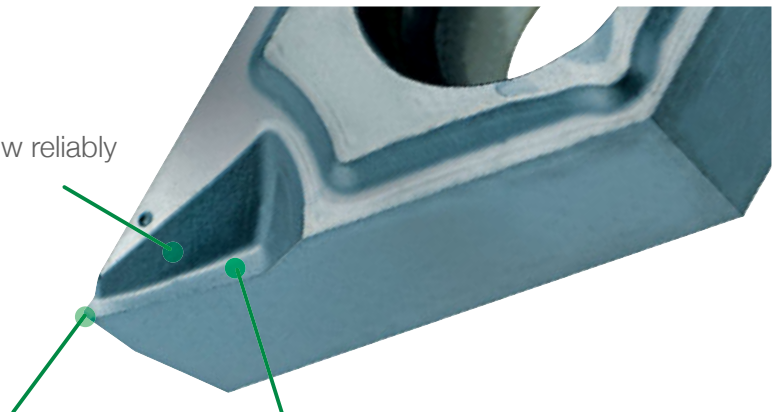

Shape to prevent cutting edge damage from chipping

Rake face shape to withstand high cutting feeds

Achieving extended tool life and stable cutting performance in vibration cutting

TMV Chipbreaker

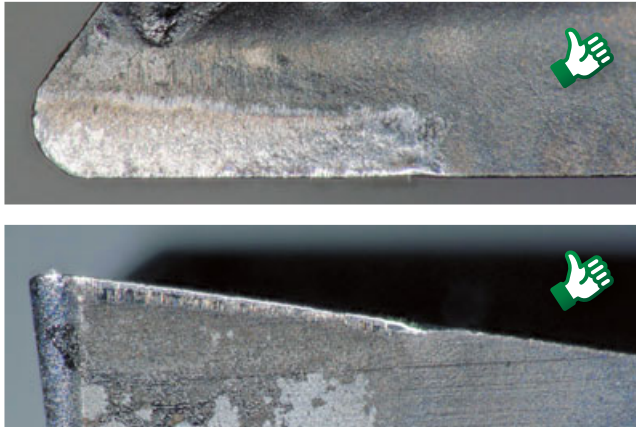

conventional

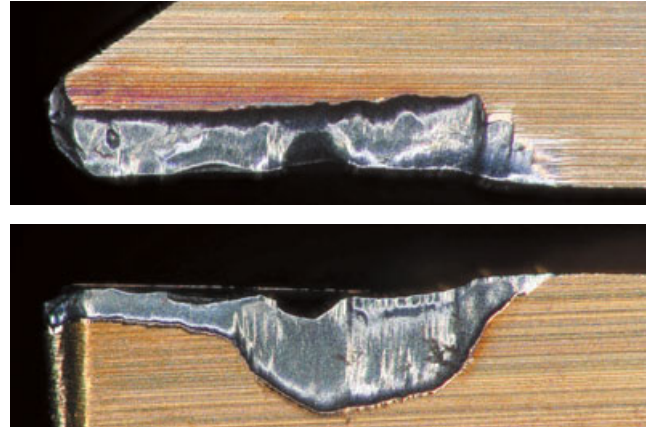

Cutting conditions

Grade	Work materials	Operation	Cutting conditions		
			Cutting speed (m/min)	Feed (mm/rev)	D.O.C. (mm)
ST4	Austenitic stainless steel (SUS304 / SUS316 etc)	Front turning	40 - 100	0.02 - 0.06	0.5 - 2.0
DM4	Carbon steel / Alloy steel (S45C / SCM435 etc)		50 - 120		
TM4	Non-ferrous (Aluminum / Titanium etc)		60 - 150		

Vibration condition

CITIZEN MACHINERY CO., LTD. (LFV)		
P	Q	D
Mode 1	0.5	0.5

* Our products are designed with a low cutting edge, please use them after aligning with the center.

* When using insert radius R0.08, please set the feed rate to 0.02 mm/rev or less.

If you want to increase the feed rate beyond 0.02 mm/rev. we recommend using the [Mode 2 / E4.0 / R0.5]

Star precision Co., Ltd. (Step Cycle Pro)	
A (Chip length factor)	D (Amplitude factor)
More than 2.0	More than 2.0

* Our products are designed with a low cutting edge, please use them after aligning with the center.

* When using insert radius R0.08, please set the feed rate to 0.02 mm/rev or less.

Grade
1
Insert
2
Ext. Toolholder
3
Int. Toolholder
4
Threading
5
Grooving
6
Shaper
7
Endmill
8
Drilling Tool
9
Technical Reference
10

The Front Max

For front turning | Swiss CNC Lathes

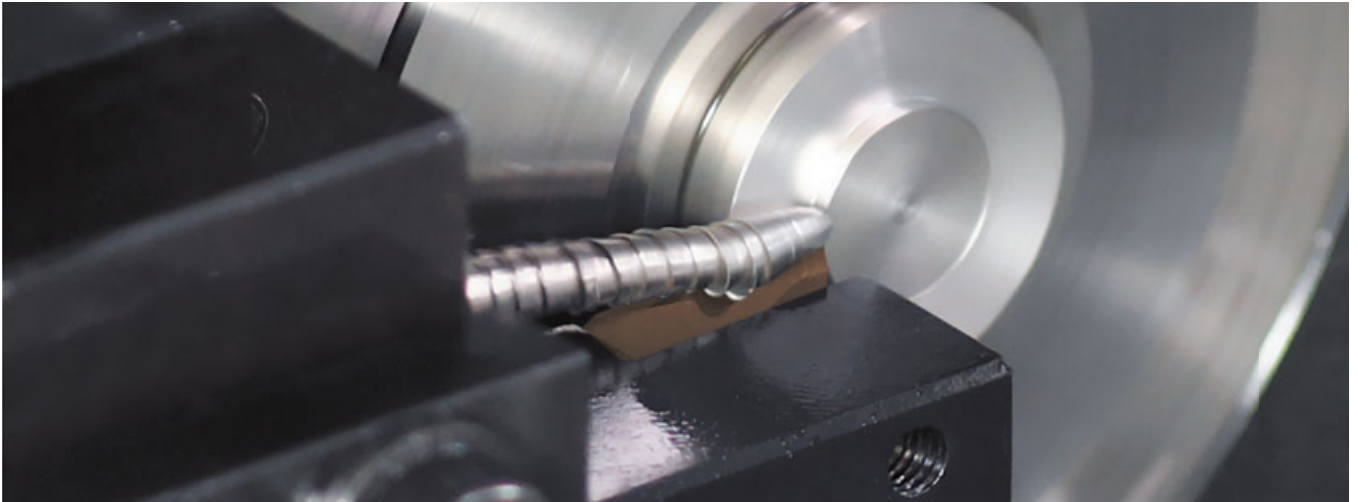

Maximum depth of cut 5.0 mm
Single pass machining reduces cycle time

Fewer machining passes reduce insert wear. Tool life can be extended.

Uniquely Designed Chipbreaker Achieves Excellent Chip Control And Machined Surfaces.

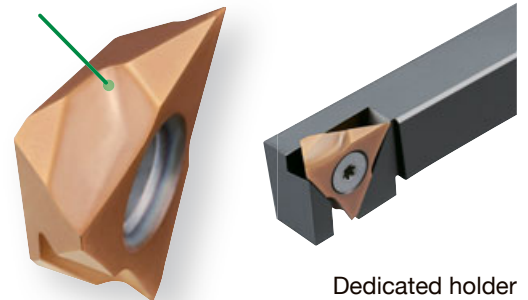
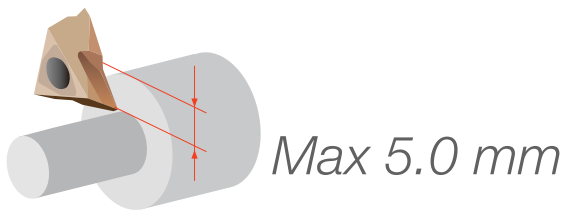

Case study

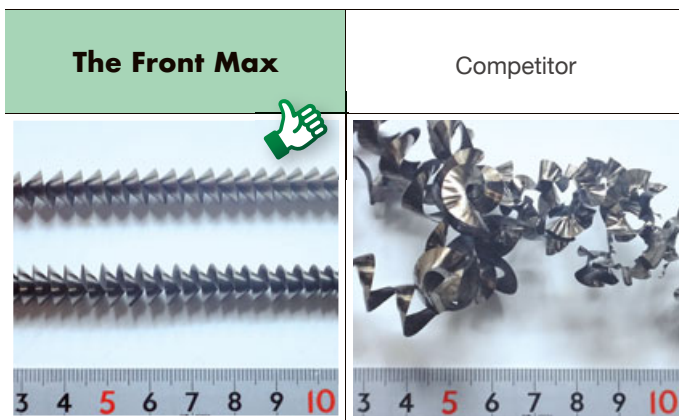

material: AISI304
ap 5.0mm vc=80m/min f=0.03mm/rev WET

Functioning range

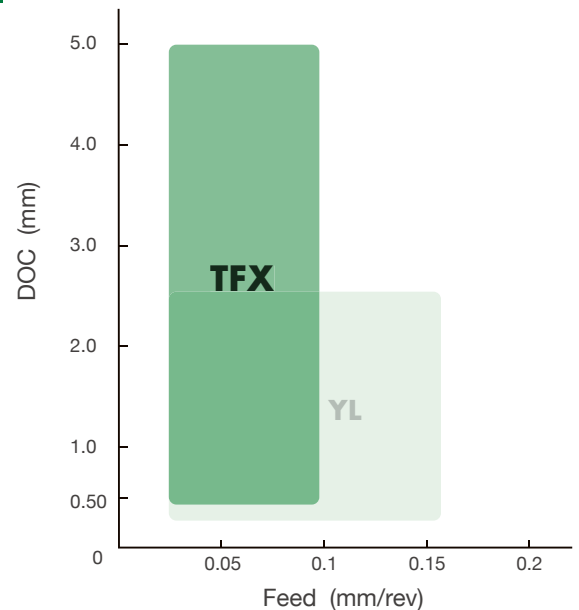

Adjustable centerline height DS tool holders

For front turning | Swiss CNC Lathes

Instantly adjust cutting edge height, reducing time and elevating quality



Angle of rotation	Increase cutting edge height
180°	0.05
360°	0.10
540°	0.20
720°	0.30

* The amount of cutting edge height increase differs depending on the model number.

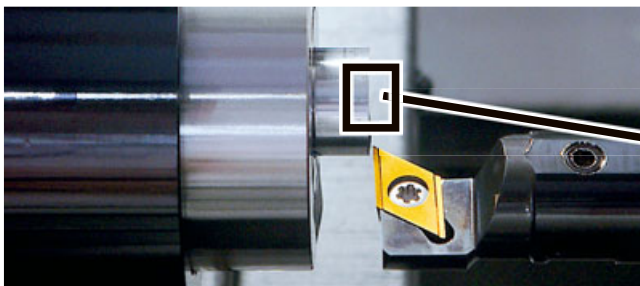

1. Take a facing test cut slightly below centerline

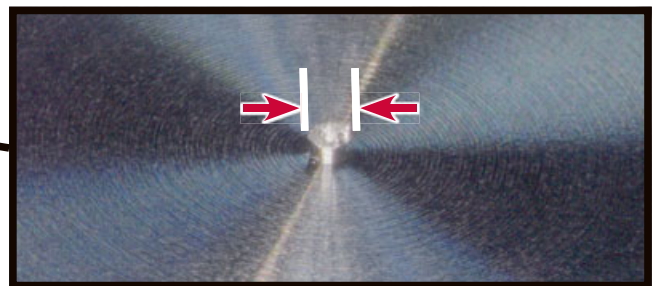

2. Measure the dia. of center boss

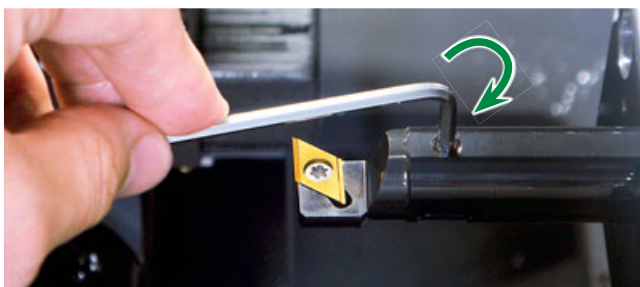

3. Raise the center height by one half of the dia. of the boss.

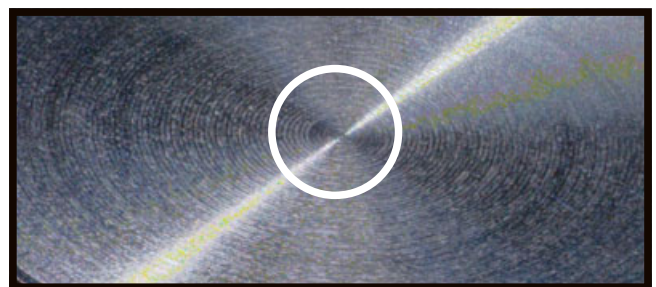

4. Re-machine the end face

Grade

Insert

Ext. Toolholder

Int. Toolholder

Threading

Grooving

Shaper

Endmill

Drilling Tool

Technical Reference

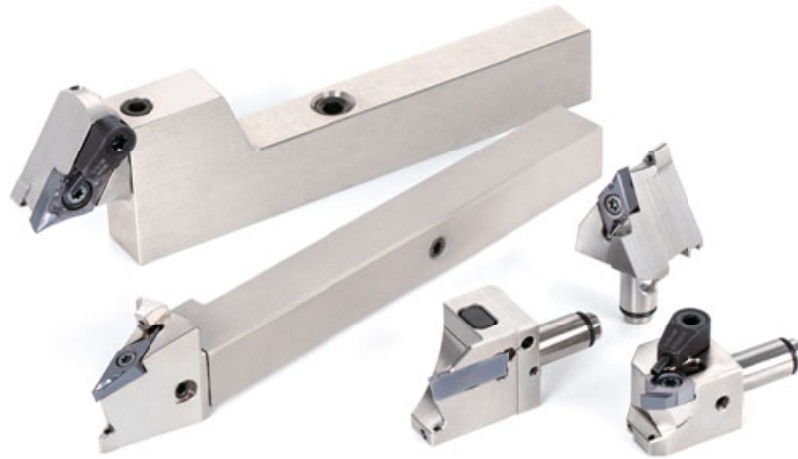

Modular style Swiss turning tool system facilitates tool changes with high repeatability

Unique coupling design

Simply loosen the clamping screw for easy tool exchanges. Unique coupling design allows extremely high repeatability.

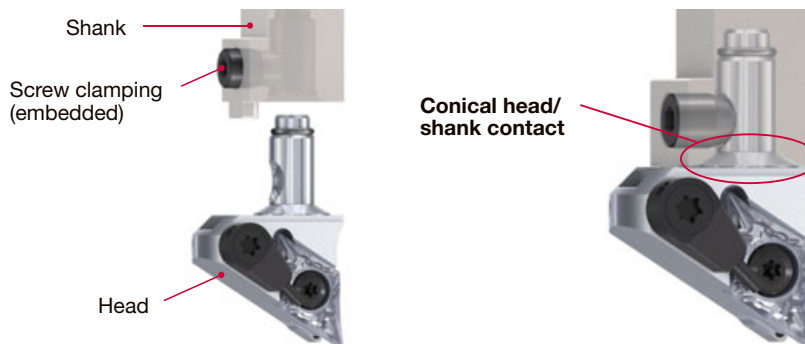

Benefits of Y-axis feed

Designed with common functional lengths (LF), the cutting heads allow easy tool changes without removing the shank from the tool post.

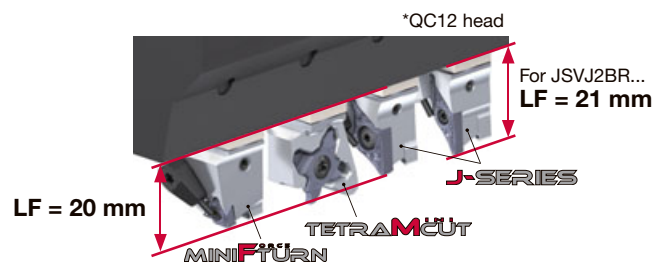

Benefits of Y-axis feed

No chip entanglements — Chips are directed downward and away from the cutting zone

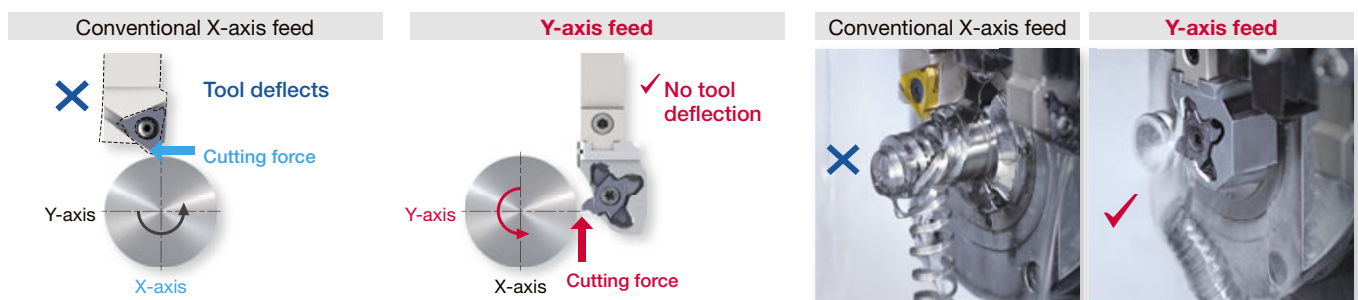

CC



**Rhombic, 80°
with hole
Positive 7°**

MODUM^{INI}TURN

QC12-JSCL2CR-Y-CHP

Screw-on Y-axis turning modular head with 95° approach angle, for positive 80° rhombic inserts, with high pressure coolant capability

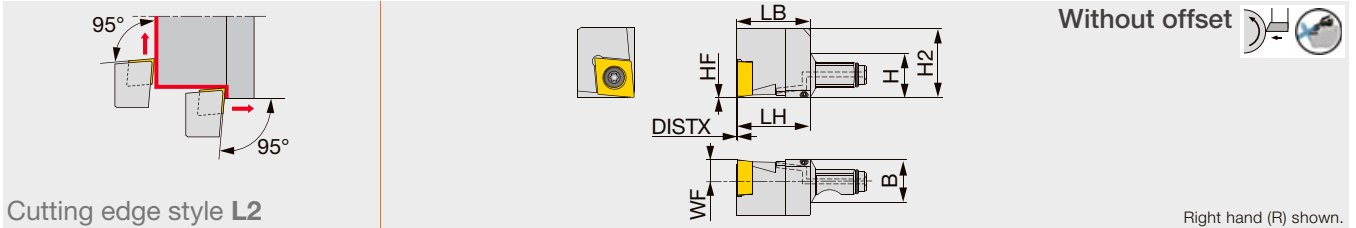

Designation	H	B	LH	HF	WF	LB	H2	DISTX	RE**	Insert	Torque*
QC12-JSCL2CR09-Y-CHP	12	12	19.5	0	6	19.8	18.6	0.3	0.2	CC**09T3...	1.2
QC16-JSCL2CR09-Y-CHP	16	16	21	0	8	21.3	16	0.3	0.2	CC**09T3...	1.2

Torque*: Recommended clamping torque (N·m)
RE**: Standard corner radius

SPARE PARTS

Designation	Clamping screw	Wrench	O-ring
QC**-JSCL2CR09-Y-CHP	CSTB-4SD	T-8F	ORSS-0454.5X1.0NBR70

QC12-JSCL2CR-CHP

Screw-on modular head with 95° approach angle, for positive 80° rhombic inserts, with high pressure coolant capability

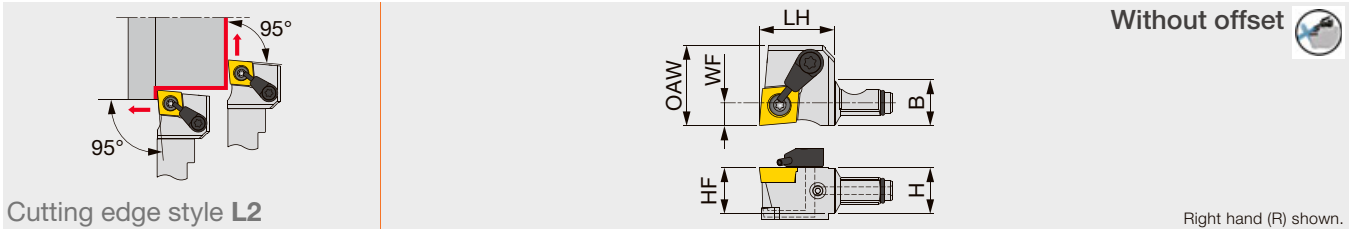

Designation	H	B	LH	HF	WF	OAW	RE**	Insert	Torque*
QC10-JSCL2CR06-CHP	10	10	17	10	5	13	0.2	CC**0602...	1.2
QC12-JSCL2CR09-CHP	12	12	19.5	12	6	21	0.2	CC**09T3...	1.2
QC16-JSCL2CR09-CHP	16	16	21	16	8	20	0.2	CC**09T3...	1.2

Torque*: Recommended clamping torque (N·m)
RE**: Standard corner radius

SPARE PARTS

Designation	Clamping screw	Coolant unit	Wrench	O-ring
QC10-JSCL2CR09-CHP	CSTB-2.5	-	T-8F	ORSS-0353.5X1.0NBR70
QC12-JSCL2CR09-CHP	CSTB-4SD	S-CU-CHP	T-8F	ORSS-0454.5X1.0NBR70
QC16-JSCL2CR09-CHP	CSTB-4SD	S-CU-CHP	T-8F	ORSS-0757.5X1.0NBR70

CC



**Rhombic, 80°
with hole
Positive 7°**

J-SERIES JSCL2CR/L

Screw-on toolholder with 95° approach angle, for positive 80° rhombic inserts

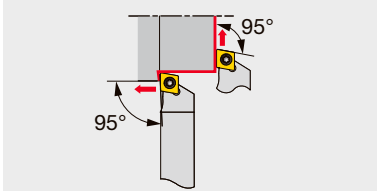

Cutting edge style **L2**

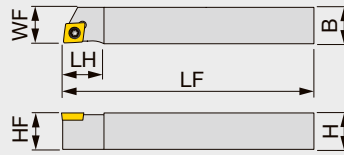

Without offset

Right hand (R) shown.

Designation	H	B	LF	LH	HF	WF	RE**	Insert	Torque*
JSCL2CR/L1010X06	10	10	120	12	10	10	0.2	CC**0602...	1.2
JSCL2CR/L1212F06	12	12	85	12	12	12	0.2	CC**0602...	1.2
JSCL2CR/L1212X06	12	12	120	12	12	12	0.2	CC**0602...	1.2
JSCL2CR/L1212F09	12	12	85	16	12	12	0.2	CC**09T3...	1.2
JSCL2CR/L1212X09	12	12	120	16	12	12	0.2	CC**09T3...	1.2
JSCL2CR/L1616X09	16	16	120	16	16	16	0.2	CC**09T3...	1.2

Torque*: Recommended clamping torque (N-m)

RE**: Standard corner radius

SPARE PARTS



Designation	Clamping screw	Wrench 1	Wrench 2 (Optional)
JSCL2CR/L**06	CSTB-2.5	T-8F	(T-8L)
JSCL2CR/L**09	CSTB-4SD	T-8F	(T-8L)

SCLC-N-OH3

Screw-on toolholder with 95° approach angle, for positive 80° rhombic inserts, with high pressure coolant capability

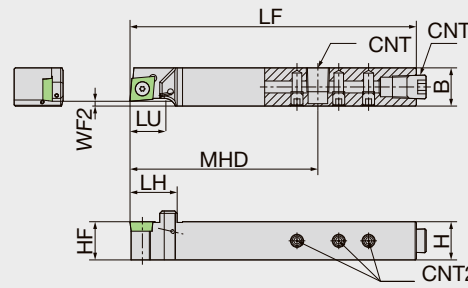
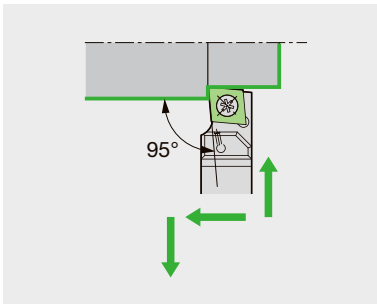

Right hand (R) shown.

Designation	H	B	LF	LH	HF	LU	MHD	WF2	CNT	CNT2	Insert
SCLCR1012H09N-OH3	10	12	100	17	10	12	62.5	0	M6*1	M5	CC..09T3..
SCLCR1616X09N-F02OH3	16	16	120	20	16	17.7	78.75	2	Rc1/8	M5	CC..09T3..

NOTE: Reference Chart of OH3 Hole Position → 10-1

SPARE PARTS



Designation	Clamp screw	Screw (for CNT)	SCREW (FOR CNT2)	Wrench (for Clamp screw)	Wrench (for CNT2)
SCLCR1012H09N-OH3	LRIS-4*10	SS0605SC	SS0505SC	LLR-25S	LW-2.5
SCLCR1616X09N-F02OH3	LRIS-4*10	SPR1/8	SS0505SC	LLR-25S	LW-2.5

Reference pages : Inserts → 2-11 -, CBN → 2-87 -, PCD → 2-119 -

SCLC-N-OH2

Screw-on toolholder with 95° approach angle, for positive 80° rhombic inserts, with high pressure coolant capability

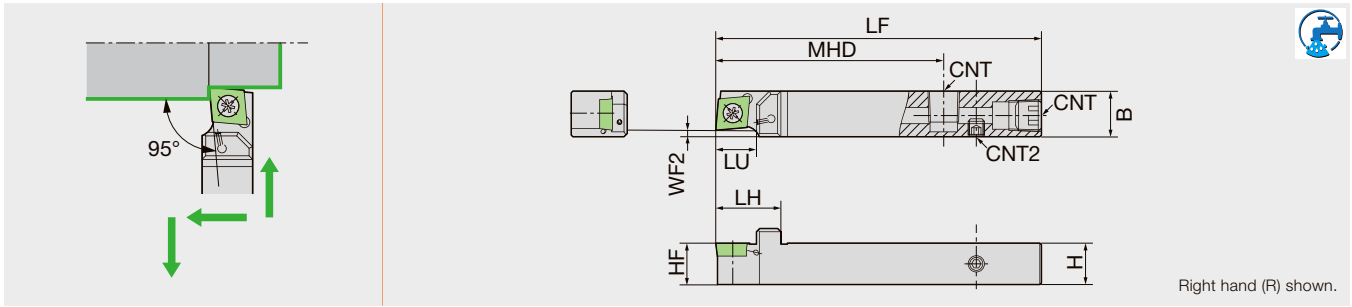

Designation	H	B	LF	LH	HF	LU	MHD	WF2	CNT	CNT2	Insert
SCLCR1214H09N-F02OH2	12	14	100	19.5	12	12	70	2	Rc1/8	M5	CC..09T3..
SCLCR1616X09N-F02OH2	16	16	120	19.5	16	17.7	70	2	Rc1/8	M5	CC..09T3..

SPARE PARTS

Designation	Clamp screw	Screw (for CNT)	Screw (for CNT2)	Wrench (for Clamp screw)	Wrench (for CNT2)
SCLCR**09N-F02OH2	LRIS-4*10	SPR1/8	SS0505SC	LLR-25S	LW-2.5

SCLC-N-OH

Screw-on toolholder with 95° approach angle, for positive 80° rhombic inserts, with high pressure coolant capability

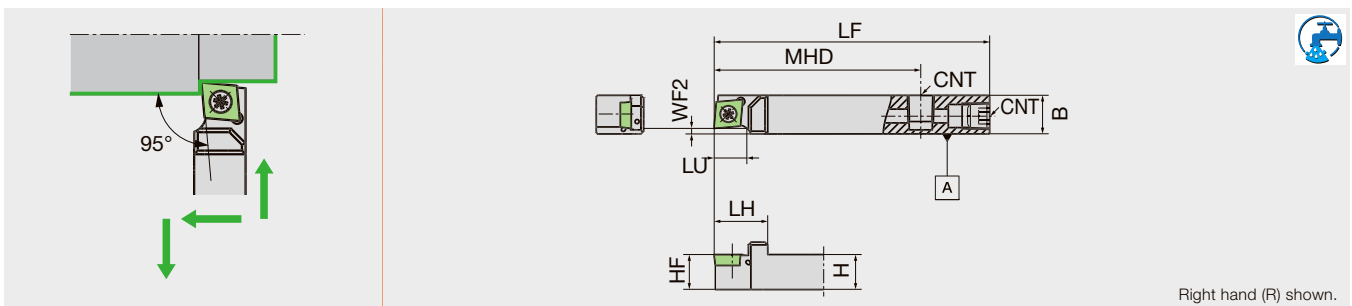

Designation	H	B	LF	LH	HF	LU	MHD	WF2	CNT	Insert
SCLCR1014F09N-F02OH	10	14	80	19.5	10	12	55	2	M6*1	CC..09T3..
SCLCR1214H09N-F02OH	12	14	100	19.5	12	12	75	2	Rc1/8	CC..09T3..
SCLCR1616H09N-F02OH	16	16	100	19.5	16	17.7	75	2	Rc1/8	CC..09T3..

SPARE PARTS

Designation	Clamp screw	Screw (for CNT)	Wrench (for Clamp screw)	Wrench (for CNT)
SCLCR1014F09N-F02OH	LRIS-4*10	SS0605SC	LLR-25S	LW-3
SCLCR**H09N-F02OH	LRIS-4*10	SPR1/8	LLR-25S	-

Reference pages : Inserts → 2-11 -, CBN → 2-87 -, PCD → 2-119 -

Grade
Insert
Ext. Toolholder
Int. Toolholder
Threading
Grooving
Shaper
Endmill
Drilling Tool
Technical Reference

CC



Rhombic, 80° with hole Positive 7°

SCLC-N

Screw-on toolholder with 95° approach angle, for positive 80° rhombic inserts

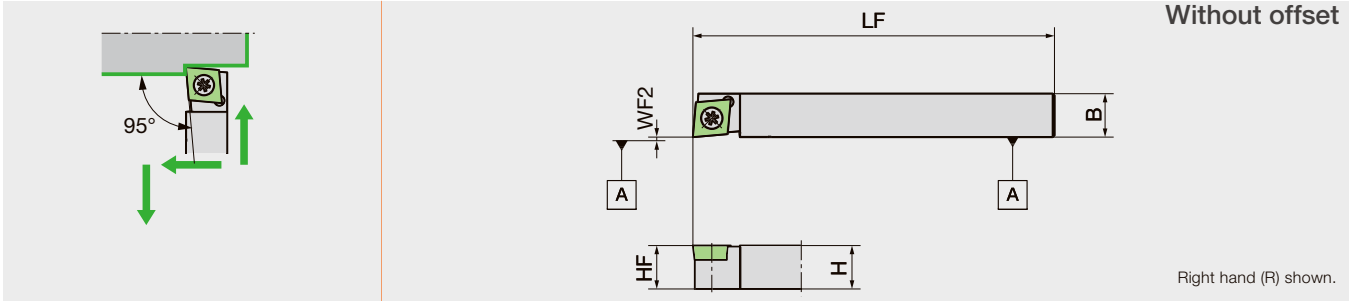

Designation	H	B	LF	HF	WF2	Insert
SCLCR0808X06N	8	8	120	8	0	CC..0602..
SCLCL0808X06N	8	8	120	8	0	CC..0602..

SPARE PARTS



Designation	Clamp screw	Wrench (for Clamp screw)
SCLCR0808X06N	LRIS-2.5*7	CLR-15S

J-SERIES

JTCL2CR/L

Back-clamp toolholder with 95° approach angle, for positive 80° rhombic inserts

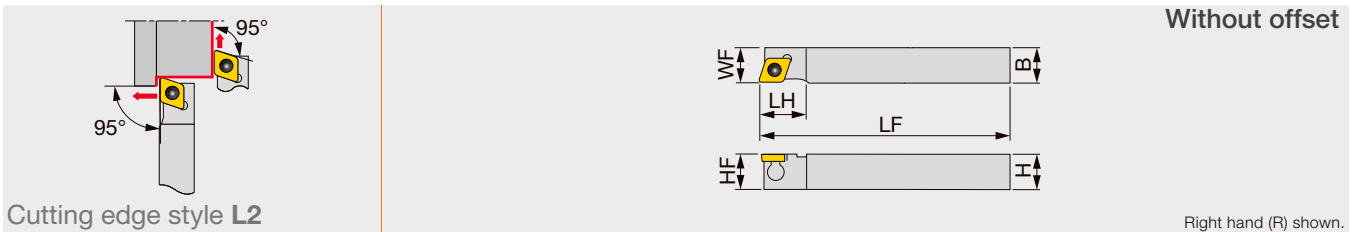

Designation	H	B	LF	LH	HF	WF	RE**	Insert	Torque*
JTCL2CR/L1010X06	10	10	120	12	10	10	0.2	CC**0602...	0.9
JTCL2CR/L1212F09	12	12	85	16	12	12	0.2	CC**09T3...	1.2
JTCL2CR/L1212X09	12	12	120	16	12	12	0.2	CC**09T3...	1.2
JTCL2CR/L1616X09	16	16	120	16	16	16	0.2	CC**09T3...	1.2

Torque*: Recommended clamping torque (N-m)
RE**: Standard corner radius

SPARE PARTS



Designation	Clamping screw	Clamp	Clamping screw	Wrench	Wrench 1	Wrench 2 (Optional)
JTCL2CR/L**06	-	JCP-2	JDS-3525	P-2F	-	-
JTCL2CR/L**09	-	JCP-3	JDS-5040	P-2.5F	-	-

Reference pages : Inserts → 2-11 -, CBN → 2-87 -, PCD → 2-119 -

Screw-on stepped-head toolholder with 95° approach angle, for positive 80° rhombic inserts

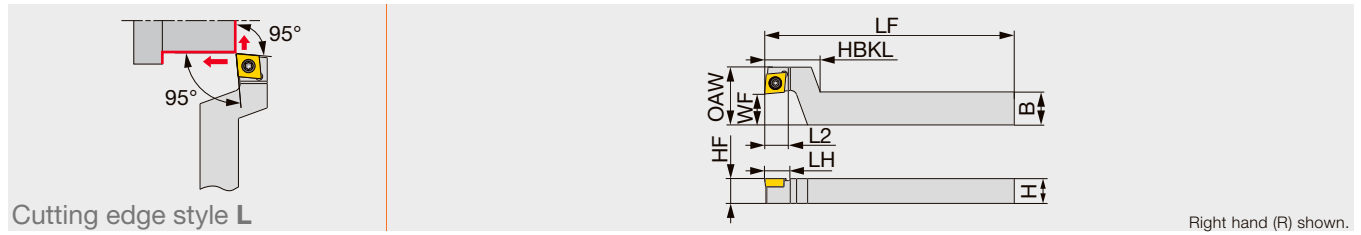

Cutting edge style L

Right hand (R) shown.

Designation	H	B	LF	L2	HBKL	LH	HF	WF	OAW	RE**	Insert	Torque*
JSCLCR1216F09-F15	12	16	85	12	27	12.5	12	15	28	0.2	CC**09T3...	1.2
JSCLCR1216X09-F15	12	16	120	12	27	12.5	12	15	28	0.2	CC**09T3...	1.2
JSCLCR1620X09-F15	16	20	120	12	27	12.5	16	15	28	0.2	CC**09T3...	1.2

Torque*: Recommended clamping torque (N·m)

RE**: Standard corner radius

SPARE PARTS

Designation	Clamping screw	Wrench 1	Wrench 2 (Optional)
JSCLCR**F15	CSTB-4SD	T-8F	(T-8L)

SCLC-N-F

Screw-on stepped-head toolholder with 95° approach angle, for positive 80° rhombic inserts

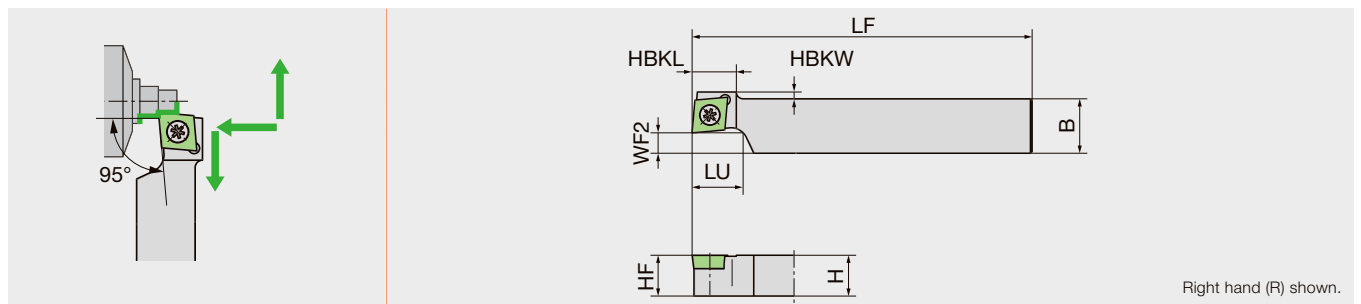

Right hand (R) shown.

Designation	H	B	LF	HBKW	HBKL	HF	LU	WF2	Insert
SCLCR1015X09N-F05	10	15	120	2	13	10	12	5	CC..09T3..
SCLCR1020X09N-F10	10	20	120	2	13	10	12	10	CC..09T3..
SCLCR1218X09N-F06	12	18	120	-	13	12	12	6	CC..09T3..
SCLCR1224X09N-F12	12	24	120	-	13	12	12	12	CC..09T3..

SPARE PARTS

Designation	Clamp screw	Wrench (for Clamp screw)
SCLCR1**	LRIS-4*10	LLR-25S

CC



Rhombic, 80° with hole
Positive 7°

DS-SCL-ACH

Screw-on round-shank toolholder with 95° approach angle, for positive 80° rhombic inserts, with adjustable centerline height capability

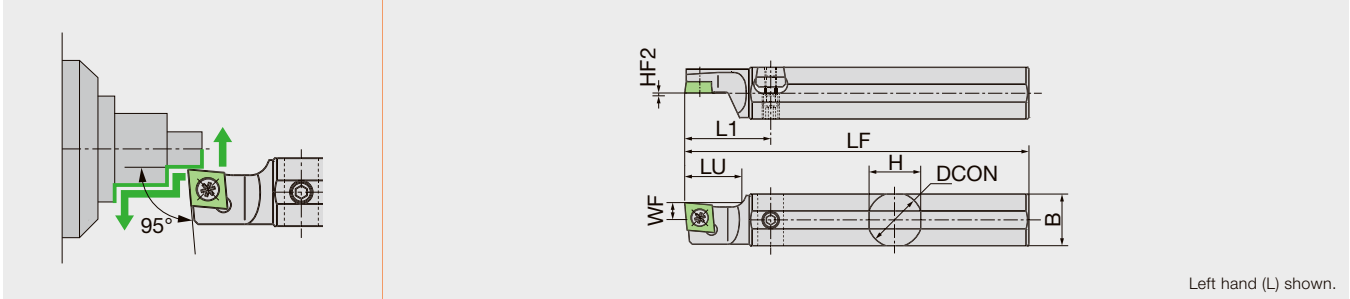

Designation	H	B	LF	DCON	HF2	LU	L1	WF	Insert
DS-SCLL16F-09-ACH	15.5	15.5	80	16	Type B(0~+0.3)	20	30	6	CC..09T3..
DS-SCLL19-09-ACH	18	18	120	19.05	Type A(0~+0.2)	20	30	6	CC..09T3..
DS-SCLL20-09-ACH	19	19	120	20	Type A(0~+0.2)	20	30	6	CC..09T3..
DS-SCLL22-09-ACH	21	21	120	22	Type A(0~+0.2)	20	30	6	CC..09T3..
DS-SCLL25-09-ACH	24	24	150	25.4	Type A(0~+0.2)	20	30	6	CC..09T3..
DS-SCLL25-09MET-ACH	24	24	150	25	Type A(0~+0.2)	20	30	6	CC..09T3..

NOTE: Use a right-handed (R) or non-handed insert.

SPARE PARTS

Designation	Clamp screw	Screw (for Wedge)	Wedge	Wrench (for Clamp screw)	Wrench (for Wedge)
DS-SCLL**-ACH	LRIS-4*8	WS060415-003	ACH-W18	LLR-25S-20*65	LW-3
DS-SCLL25-09**-ACH	LRIS-4*8	WS060419-004	ACH-W24	LLR-25S-20*65	LW-3

DS-SCL

Screw-on round-shank toolholder with 95° approach angle, for positive 80° rhombic inserts

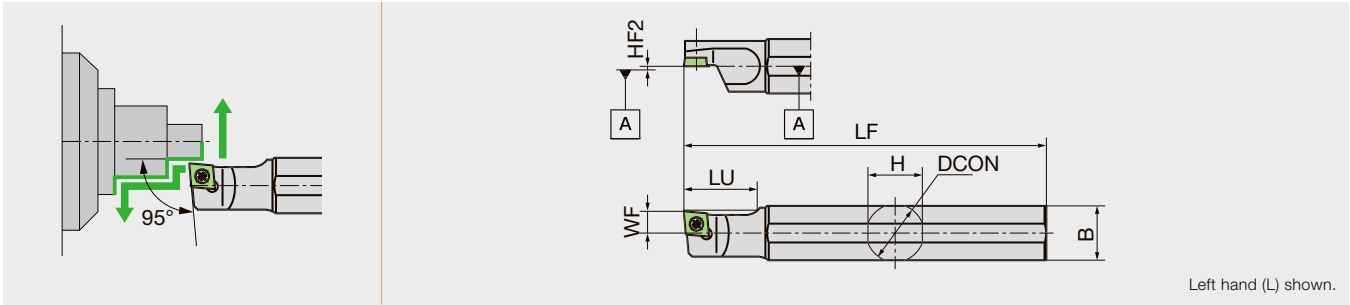

Designation	H	B	LF	DCON	HF2	LU	WF	Insert
DS-SCLL15H-06	15	15	100	15.875	0	20	6	CC..0602..
DS-SCLL15H-09	15	15	100	15.875	0	20	6	CC..09T3..
DS-SCLL16F-06	15	15	80	16	0	20	6	CC..0602..
DS-SCLL16F-09	15	15	80	16	0	20	6	CC..09T3..
DS-SCLL19-06	18	18	120	19.05	0	20	6	CC..0602..
DS-SCLL19-09	18	18	120	19.05	0	20	6	CC..09T3..
DS-SCLL19GX-09	18	18	85	19.05	0	20	6	CC..09T3..
DS-SCLL20-06	19	19	120	20	0	20	6	CC..0602..
DS-SCLL20-09	19	19	120	20	0	20	6	CC..09T3..
DS-SCLL20X-06	19	19	95	20	0	20	6	CC..0602..
DS-SCLL20X-09	19	19	95	20	0	20	6	CC..09T3..
DS-SCLL22-06	21	21	120	22	0	20	6	CC..0602..
DS-SCLL22-09	21	21	120	22	0	20	6	CC..09T3..
DS-SCLL25-06	24	24	120	25.4	0	20	6	CC..0602..
DS-SCLL25-06MET	24	24	120	25	0	20	6	CC..0602..
DS-SCLL25-09	24	24	150	25.4	0	20	6	CC..09T3..
DS-SCLL25-09MET	24	24	120	25	0	20	6	CC..09T3..
DS-SCLL32-09	30	30	150	32	0	20	6	CC..09T3..

NOTE: Use a right-handed (R) or non-handed insert.

SPARE PARTS



Designation	Clamp screw	Wrench (for Clamp screw)
DS-SCLL**06**	LRIS-2.5*7	CLR-15S
DS-SCLL**09**	LRIS-4*8	LLR-25S-20*65

Reference pages : Inserts → 2-11 -, CBN → 2-87 -, PCD → 2-119 -

Grade 1
Insert 2
Ext. Toolholder 3
Int. Toolholder 4
Threading 5
Grooving 6
Shaper 7
Endmill 8
Drilling Tool 9
Technical Reference 10

CC



Rhombic, 80°
with hole
Positive 7°

MODUM^{INI}TURN

QR12-SCLCL-CHP

J-SERIES

Screw-on modular head with 95° approach angle, for positive 80° rhombic inserts, with high pressure coolant capability

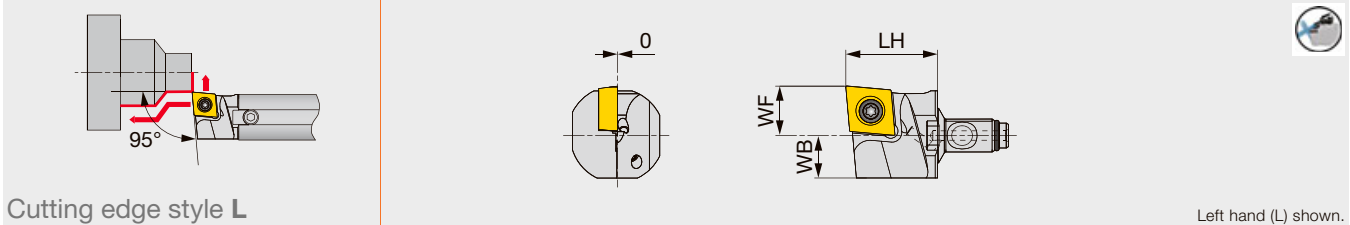

Left hand (L) shown.

Designation	LH	WF	WB	RE**	Insert	Torque*	Shank
QR12C-SCLCL09-CHP	19.5	8.5	8	0.2	CC**09T3...	1.2	A16*-QR12
QR12D-SCLCL09-CHP	19.5	10.5	9	0.2	CC**09T3...	1.2	A19/20*-QR12

Torque*: Recommended clamping torque (N-m)
RE**: Standard corner radius
Assembled dimensions with shank are shown on page 9.

SPARE PARTS

Designation	Clamping screw	Wrench	O-ring
QR12*-SCLCL09-CHP	CSTB-4SD	T-8F	ORSS-0454.5X1.0NBR70

C-SCLCL-CHP

TUNG^{URN}TJET

Screw-on toolholder, with 95° approach angle, for positive 80° rhombic inserts, with high pressure coolant capability

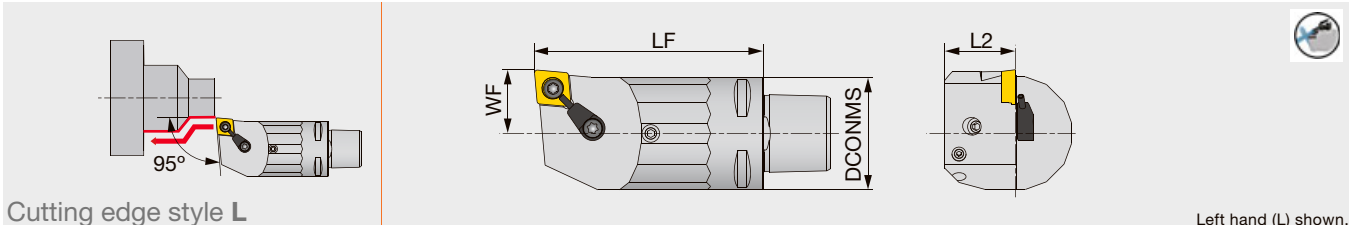

Left hand (L) shown.

Designation	DCONMS	LF	L2	WF	RE	Insert
C3SCLCL18040-09-CHP	32	40	20	18	0.8	CC**09T3...
C3SCLCL18065-09-CHP	32	65	20	18	0.8	CC**09T3...

Applicable for 14 MPa coolant
Cannot be used for boring

SPARE PARTS

Designation	Clamping screw	Coolant unit	Wrench
C3SCLCL...	CSTB-4S	S-CU-CHP	T-15F

DC

 **Rhombic, 55°
with hole
Positive 7°**

MODUM^{INI}TURN

QC12/16-JSDJ2CR-Y-CHP

Screw-on Y-axis turning modular head with 93° approach angle, for positive 55° rhombic inserts, with high pressure coolant capability

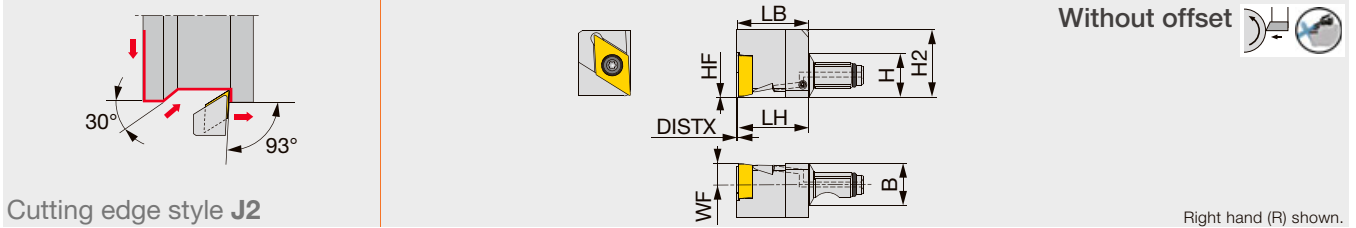

Designation	H	B	LH	HF	WF	LB	H2	DISTX	RE**	Insert	Torque*
QC12-JSDJ2CR11-Y-CHP	12	12	19.5	0	6	19.8	18.7	0.3	0.2	DC**11T3...	1.2
QC16-JSDJ2CR11-Y-CHP	16	16	21	0	8	21.3	18.7	0.3	0.2	DC**11T3...	1.2

Torque*: Recommended clamping torque (N·m)
RE**: Standard corner radius

SPARE PARTS

Designation	Clamping screw	Wrench	O-ring
QC**-JSDJ2CR11-Y-CHP	CSTB-4SD	T-8F	ORSS-0454.5X1.0NBR70

QC12-JSDJ2CR-CHP

Screw-on modular head with 93° approach angle, for positive 55° rhombic inserts, with high pressure coolant capability

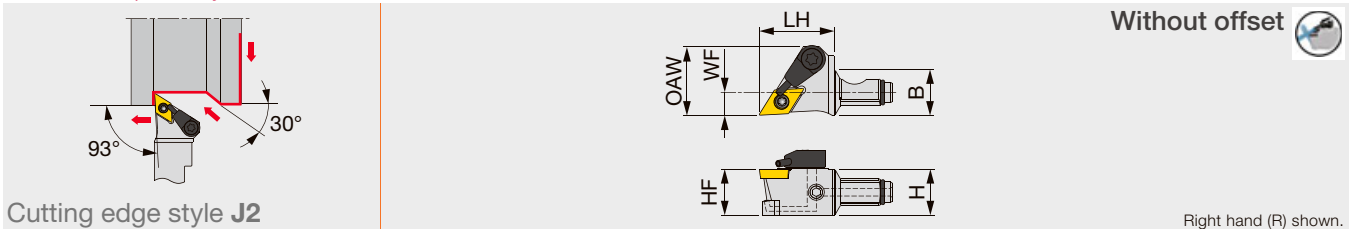

Designation	H	B	LH	HF	WF	OAW	RE**	Insert	Torque*
QC10-JSDJ2CR07-CHP	10	10	17	10	5	13	0.2	DC**0702...	1.2
QC12-JSDJ2CR07-CHP	12	12	19.5	12	6	18	0.2	DC**0702...	1.2
QC12-JSDJ2CR11-CHP	12	12	19.5	12	6	21	0.2	DC**11T3...	1.2
QC16-JSDJ2CR11-CHP	16	16	21	16	8	20	0.2	DC**11T3...	1.2

Torque*: Recommended clamping torque (N·m)
RE**: Standard corner radius

SPARE PARTS

Designation	Clamping screw	Coolant unit	Wrench	O-ring
QC10-JSDJ2CR07-CHP	CSTB-2.5	-	T-8F	ORSS-0353.5X1.0NBR70
QC12-JSDJ2CR07-CHP	CSTB-2.5	S-CU-CHP	T-8F	ORSS-0454.5X1.0NBR70
QC12-JSDJ2CR11-CHP	CSTB-4SD	S-CU-CHP	T-8F	ORSS-0454.5X1.0NBR70
QC16-JSDJ2CR11-CHP	CSTB-4SD	S-CU-CHP	T-8F	ORSS-0757.5X1.0NBR70

Reference pages : Inserts → 2-23 -, CBN → 2-91 -, PCD → 2-120 -, Shank, Accessory → 3-120

Grade
Insert
Ext. Toolholder
Int. Toolholder
Threading
Grooving
Shaper
Endmill
Drilling Tool
Technical Reference

DC

 **Rhombic, 55° with hole**
Positive 7°

SDJC-N-OH3

Screw-on toolholder with 93° approach angle, for positive 55° rhombic inserts, with high pressure coolant capability

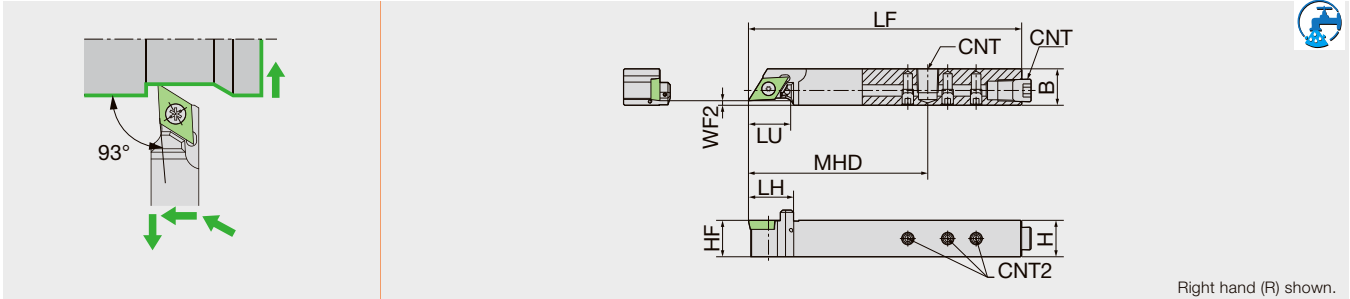

Right hand (R) shown.

Designation	H	B	LF	LH	HF	LU	MHD	WF2	CNT	CNT2	Insert
SDJCR1012H11N-OH3	10	12	100	16.8	10	16	62.5	0	M6*1	M5	DC..11T3.. DC..11T3..WP(TFD11..)
SDJCR1616X11N-F02OH3	16	16	120	19.8	16	18.4	78.75	2	Rc1/8	M5	DC..11T3.. DC..11T3..WP(TFD11..)

NOTE: Reference Chart of OH3 Hole Position → 10-1

SPARE PARTS

Designation	Clamp screw	Screw (for CNT)	Screw (for CNT2)	Wrench (for Clamp screw)	Wrench (for CNT2)
SDJCR1012H11N-OH3	LRIS-4*10	SS0605SC	SS0505SC	LLR-25S	LW-2.5
SDJCR1616X11N-F02OH3	LRIS-4*10	SPR1/8	SS0505SC	LLR-25S	LW-2.5

SDJC-N-OH2

Screw-on toolholder with 93° approach angle, for positive 55° rhombic inserts, with high pressure coolant capability

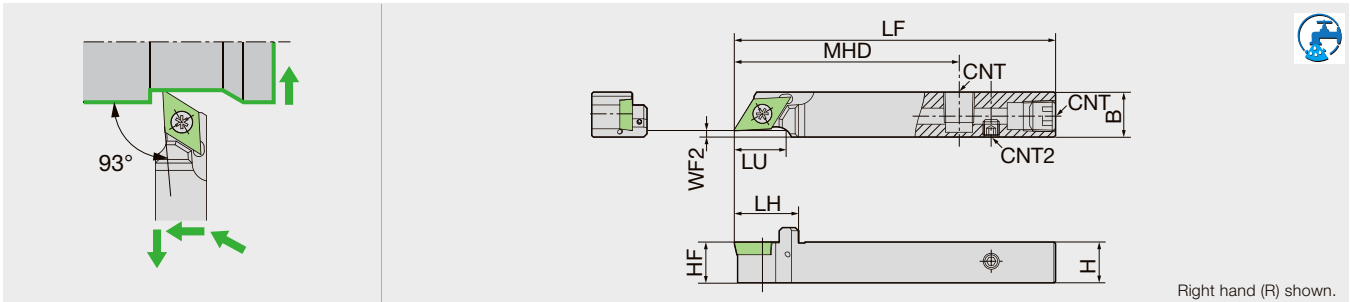

Right hand (R) shown.

Designation	H	B	LF	LH	HF	LU	MHD	WF2	CNT	CNT2	Insert
SDJCR1214H11N-F02OH2	12	14	100	19.5	12	16	70	2	Rc1/8	M5	DC..11T3.. DC..11T3..WP(TFD11..)
SDJCR1616X11N-F02OH2	16	16	120	19.5	16	18.4	70	2	Rc1/8	M5	DC..11T3.. DC..11T3..WP(TFD11..)

SPARE PARTS

Designation	Clamp screw	Screw (for CNT)	Screw (for CNT2)	Wrench (for Clamp screw)	Wrench (for CNT2)
SDJCR1214H11N-F02OH2	LRIS-4*10	SPR1/8	SS0505SC	LLR-25S	LW-2.5
SDJCR1616X11N-F02OH2	LRIS-4*10	SPR1/8L	SS0505SC	LLR-25S	LW-2.5

Reference pages : Inserts → 2-23 -, CBN → 2-91 -, PCD → 2-120 -

SDJC-N-OH

Screw-on toolholder with 93° approach angle, for positive 55° rhombic inserts, with high pressure coolant capability

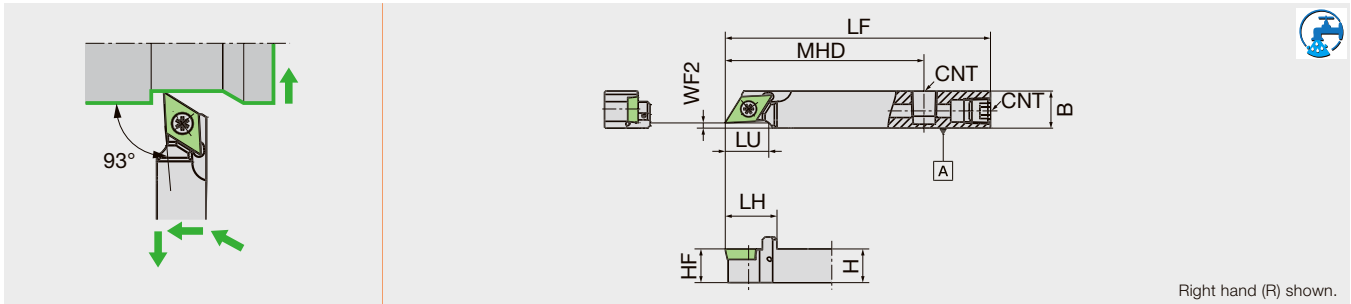

Designation	H	B	LF	LH	HF	LU	MHD	WF2	CNT	Insert
SDJCR1014F11N-F02OH	10	14	80	19.5	10	16	55	2	M6*1	DC..11T3.. WP(TFD11..)
SDJCR1214H11N-F02OH	12	14	100	19.5	12	16	75	2	Rc1/8	DC..11T3.. WP(TFD11..)
SDJCR1616H11N-F02OH	16	16	100	19.5	16	18.4	75	2	Rc1/8	DC..11T3.. WP(TFD11..)

SPARE PARTS

Designation	Clamp screw	Screw (for CNT)	Wrench (for Clamp screw)	Wrench (for CNT2)
SDJCR1014F11N-F02OH	LRIS-4*10	SS0605SC	LLR-25S	LW-3
SDJCR1214H11N-F02OH	LRIS-4*10	SPR1/8	LLR-25S	-
SDJCR1616H11N-F02OH	LRIS-4*10	SPR1/8	LLR-25S	-

J-SERIES

JSDJ2CR/L

Screw-on toolholder with 93° approach angle, for positive 55° rhombic inserts

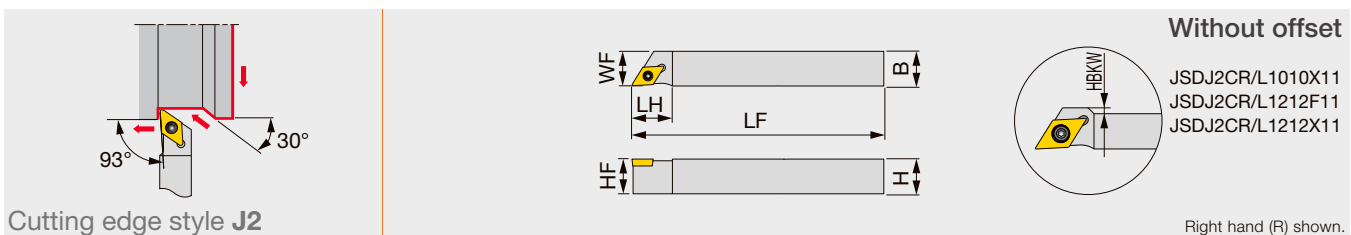

Cutting edge style J2

Designation	H	B	LF	LH	HF	WF	HBKW	RE**	Insert	Torque*
JSDJ2CR/L0808F07	8	8	85	14	8	8	-	0.2	DC**0702...	1.2
JSDJ2CR/L1010X07	10	10	120	14	10	10	-	0.2	DC**0702...	1.2
JSDJ2CR/L1010X11	10	10	120	20	10	10	4	0.2	DC**11T3...	1.2
JSDJ2CR/L1212F07	12	12	85	14	12	12	-	0.2	DC**0702...	1.2
JSDJ2CR/L1212F11	12	12	85	20	12	12	2	0.2	DC**11T3...	1.2
JSDJ2CR/L1212X07	12	12	120	14	12	12	-	0.2	DC**0702...	1.2
JSDJ2CR/L1212X11	12	12	120	20	12	12	2	0.2	DC**11T3...	1.2
JSDJ2CR/L1616X11	16	16	120	20	16	16	-	0.2	DC**11T3...	1.2

Torque*: Recommended clamping torque (N-m)
RE**: Standard corner radius

SPARE PARTS

Designation	Clamping screw	Wrench	Wrench 1 (Optional)
JSDJ2CR/L**07	CSTB-2.5	T-8F	(T-8L)
JSDJ2CR/L**11	CSTB-4SD	T-8F	(T-8L)

Reference pages : Inserts → 2-23 -, CBN → 2-91 -, PCD → 2-120 -

Grade
Insert
Ext. Toolholder
Int. Toolholder
Threading
Grooving
Shaper
Endmill
Drilling Tool
Technical Reference

DC

**Rhombic, 55°
with hole
Positive 7°**

J-SERIES JTDJ2CR/L

Back-clamp toolholder with 93° approach angle, for positive 55° rhombic inserts

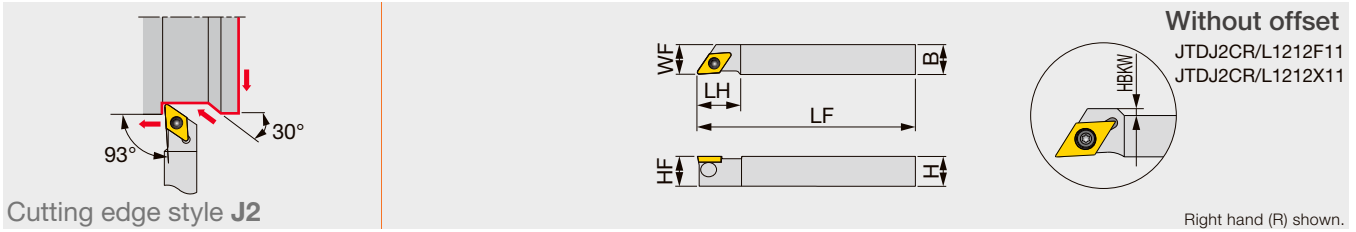

Right hand (R) shown.

Designation	H	B	LF	LH	HF	WF	HBKW	RE**	Insert	Torque*
JTDJ2CR/L1010X07	10	10	120	14	10	10	-	0.2	DC**0702...	0.9
JTDJ2CR/L1212F07	12	12	85	14	12	12	-	0.2	DC**0702...	0.9
JTDJ2CR/L1212X07	12	12	120	14	12	12	-	0.2	DC**0702...	0.9
JTDJ2CR/L1212F11	12	12	85	20	12	12	2	0.2	DC**11T3...	1.2
JTDJ2CR/L1212X11	12	12	120	20	12	12	2	0.2	DC**11T3...	1.2
JTDJ2CR/L1616X11	16	16	120	20	16	16	-	0.2	DC**11T3...	1.2

Torque*: Recommended clamping torque (N-m)

RE**: Standard corner radius

SPARE PARTS

Designation	Clamping screw	Clamp	Clamping screw	Wrench 1	Wrench 2 (Optional)
JTDJ2CR/L**07	JCP-2	JDS-3525	P-2F	-	-
JTDJ2CR/L**11	JCP-3	JDS-5040	P-2.5F	-	-

JSDJCR-F

Screw-on stepped-head toolholder with 93° approach angle, for positive 55° rhombic inserts

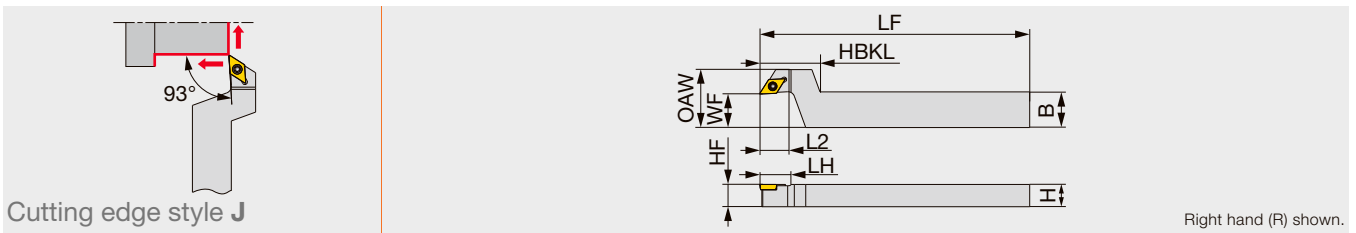

Right hand (R) shown.

Designation	H	B	LF	L2	HBKL	LH	HF	WF	OAW	RE**	Insert	Torque*
JSDJCR1016X07-F15	10	16	120	12.5	27	14	10	15	26	0.2	DC**0702...	1.2
JSDJCR1216F07-F15	12	16	85	12.5	27	14	12	15	26	0.2	DC**0702...	1.2
JSDJCR1216X07-F15	12	16	120	12.5	27	14	12	15	26	0.2	DC**0702...	1.2
JSDJCR1216F11-F15	12	16	85	12.5	27	20	12	15	28	0.2	DC**11T3...	1.2
JSDJCR1216X11-F15	12	16	120	12.5	27	20	12	15	28	0.2	DC**11T3...	1.2
JSDJCR1620X11-F15	16	20	120	12.5	27	20	16	15	28	0.2	DC**11T3...	1.2

Torque*: Recommended clamping torque (N-m)

RE**: Standard corner radius

SPARE PARTS

Designation	Clamping screw	Wrench 1	Wrench 2 (Optional)
JSDJCR**07-F15	CSTB-2.5	T-8F	(T-8L)
JSDJCR**11-F15	CSTB-4SD	T-8F	(T-8L)

Reference pages : Inserts → 2-23 -, CBN → 2-91 -, PCD → 2-120 -

SDJC-N-F

Screw-on stepped-head toolholder with 93° approach angle, for positive 55° rhombic inserts

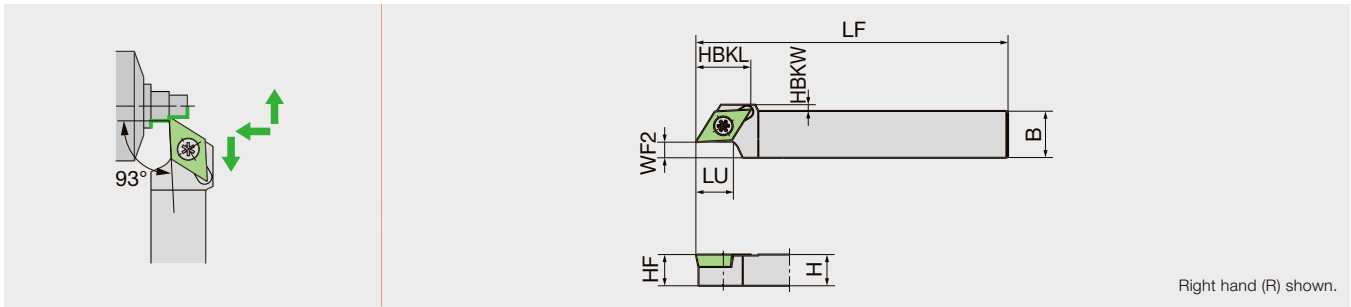

Right hand (R) shown.

Designation	H	B	LF	HBKL	HBKW	HF	LU	WF2	Insert
SDJCR1015X07N-F05	10	15	120	13	0	10	12	5	DC..0702.. WP(TFD07..)
SDJCR1015X11N-F05	10	15	120	19	2	10	12	5	DC..11T3.. WP(TFD11..)
SDJCR1020X07N-F10	10	20	120	13	0	10	12	10	DC..0702.. WP(TFD07..)
SDJCR1020X11N-F10	10	20	120	19	2	10	12	10	DC..11T3.. WP(TFD11..)
SDJCR1218X11N-F06	12	18	120	20	0	12	12	6	DC..11T3.. WP(TFD11..)
SDJCR1224X11N-F12	12	24	120	20	0	12	12	12	DC..11T3.. WP(TFD11..)
SDJCR1620X11N-F08	16	20	120	20	0	16	18.5	8	DC..11T3.. WP(TFD11..)
SDJCR1628X11N-F16	16	28	120	20	0	16	18.5	16	DC..11T3.. WP(TFD11..)

SPARE PARTS



Designation	Clamp screw	Wrench (for Clamp screw)
SDJCR**X07**	LRIS-2.5*7	CLR-15S
SDJCR**X11**	LRIS-4*10	LLR-25S

J-SERIES

JSDJCR/L

Screw-on toolholder with 93° approach angle, for positive 55° rhombic inserts

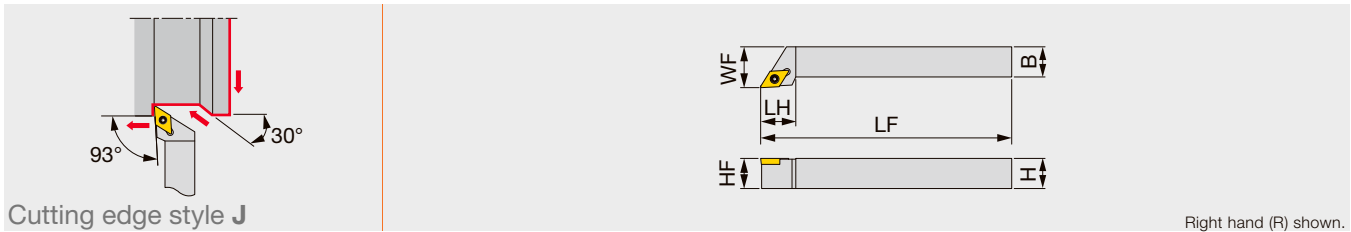

Right hand (R) shown.

Designation	H	B	LF	LH	HF	WF	RE**	Insert	Torque*
JSDJCR/L0808H07	8	8	100	14	8	10	0.4	DC**0702...	1.2
JSDJCR/L1010H11	10	10	100	18	10	12	0.8	DC**11T3...	1.2
JSDJCR/L1212H07	12	12	100	14	12	16	0.4	DC**0702...	1.2
JSDJCR/L1212H11	12	12	100	18	12	16	0.8	DC**11T3...	1.2
JSDJCR/L1616H11	16	16	100	18	16	20	0.8	DC**11T3...	1.2

Torque*: Recommended clamping torque (N-m)

RE**: Standard corner radius

SPARE PARTS



Designation	Clamping screw	Clamp	Clamping screw	Wrench 1	Wrench 2 (Optional)
JSDJ2CR/L**07	CSTB-2.5	-	-	T-8F	(T-8L)
JSDJ2CR/L**11	CSTB-4SD	-	-	T-8F	(T-8L)

Reference pages : Inserts → 2-23 -, CBN → 2-91 -, PCD → 2-120 -

Grade
Insert
Ext. Toolholder
Int. Toolholder
Threading
Grooving
Shaper
Endmill
Drilling Tool
Technical Reference

DC

 **Rhombic, 55° with hole**
Positive 7°

Y-SDJC-N-OH2

Screw-on Y-axis turning toolholder with 93° approach angle, for positive 55° rhombic inserts, with high pressure coolant capability

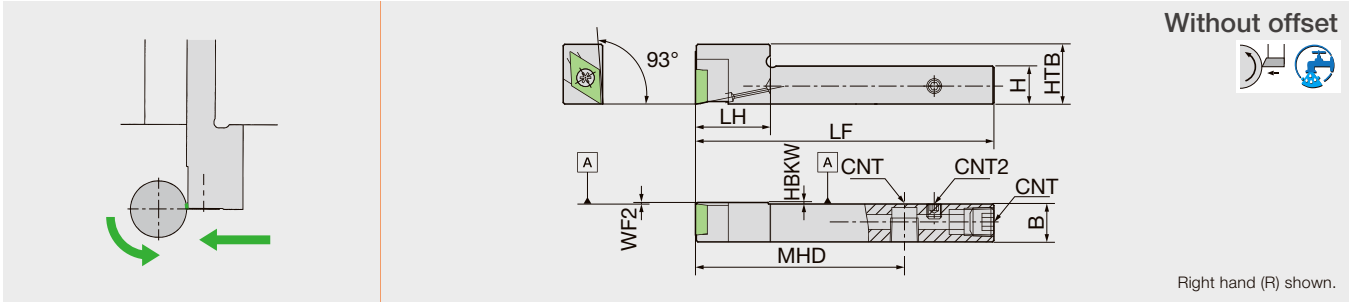

Designation	H	B	LF	LH	HBKW	HTB	MHD	WF2	CNT	CNT2	Insert
Y-SDJCR1212H11S-OH2	12	12	100	20	0.5	20	70	0	Rc1/8	M5	DC..11T3.. DC..11T3..WP(TFD11..)

NOTE: Use a right-handed (R) or non-handed insert.
NOTE: There is a risk of interference with the Y-axis holder depending on the combination of the maximum workpiece diameter and machining diameter.
→10-1

SPARE PARTS

Designation	Clamp screw	Screw (for CNT)	Screw (for CNT2)	Wrench (for Clamp screw)	Wrench (for CNT2)
Y-SDJCR1212H11S-OH2	LRIS-4*10	SPR1/8	SS0505SC	LLR-25S-20*65	LW-2.5

Y-SDJC-N-OH

Screw-on Y-axis turning toolholder with 93° approach angle, for positive 55° rhombic inserts, with high pressure coolant capability

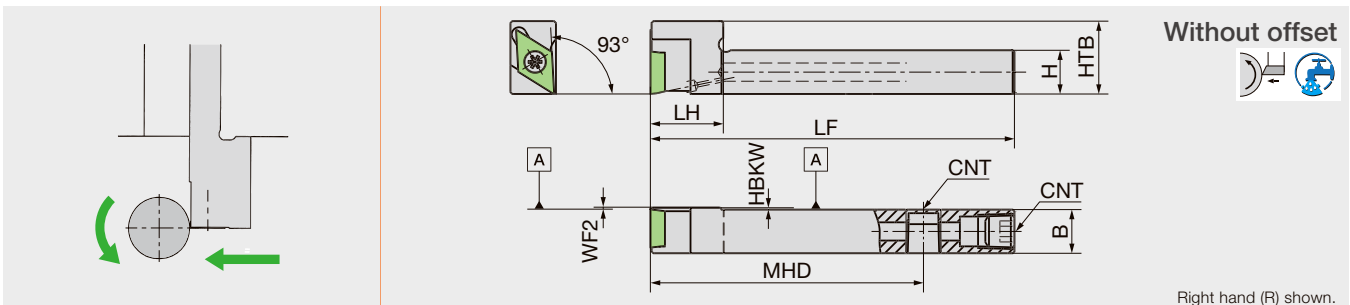

Designation	H	B	LF	LH	HBKW	HTB	MHD	WF2	CNT	Insert
Y-SDJCR1212H11S-OH	12	12	100	20	0.5	20	75	0	Rc1/8	DC..11T3.. DC..11T3..WP(TFD11..)
Y-SDJCR1616H11-OH	16	16	100	25	0.5	20	75	0	Rc1/8	DC..11T3.. DC..11T3..WP(TFD11..)

NOTE: Use a right-handed (R) or non-handed insert.
NOTE: There is a risk of interference with the Y-axis holder depending on the combination of the maximum workpiece diameter and machining diameter.
→10-1

SPARE PARTS

Designation	Clamp screw	Screw (for CNT)	Wrench (for Clamp screw)
Y-SDJCR*-OH	LRIS-4*10	SPR1/8	LLR-25S-20*65

Reference pages : Inserts → 2-23 -, CBN → 2-91 -, PCD → 2-120 -

Y-SDJC

Screw-on Y-axis turning toolholder with 93° approach angle, for positive 55° rhombic inserts

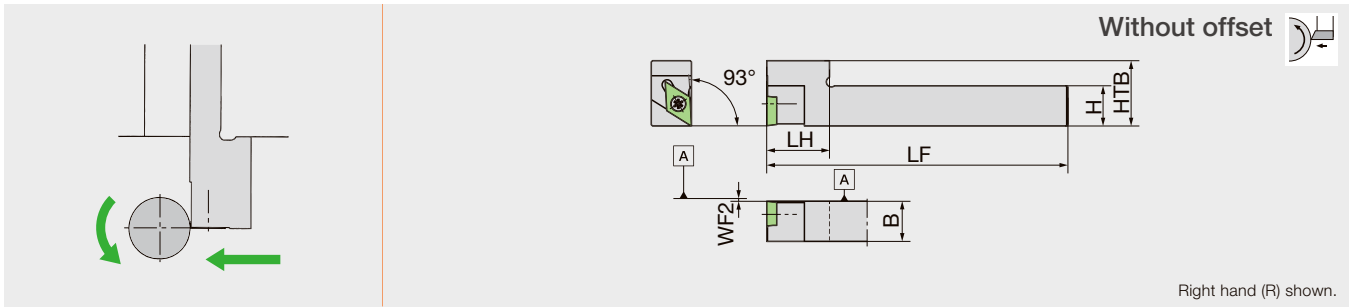

Designation	H	B	LF	LH	HTB	WF2	Insert	
Y-SDJCR10-07S	10	10	120	20	20	0	DC..0702..	DC..0702..WP(TFD07..)
Y-SDJCR10-11MS	10	10	120	22	20	0	DC..11T3..	DC..11T3..WP(TFD11..)
Y-SDJCR10-11S	10	10	120	20	20	0	DC..11T3..	DC..11T3..WP(TFD11..)
Y-SDJCR12-07S	12	12	120	20	20	0	DC..0702..	DC..0702..WP(TFD07..)
Y-SDJCR12-11MS	12	12	120	22	20	0	DC..11T3..	DC..11T3..WP(TFD11..)
Y-SDJCR12-11S	12	12	120	20	20	0	DC..11T3..	DC..11T3..WP(TFD11..)
Y-SDJCR16-11S	16	16	120	20	20	0	DC..11T3..	DC..11T3..WP(TFD11..)

NOTE: Use a right-handed (R) or non-handed insert.

NOTE: There is a risk of interference with the Y-axis holder depending on the combination of the maximum workpiece diameter and machining diameter.

→10-1

SPARE PARTS



Designation	Clamp screw	Wrench (for Clamp screw)
Y-SDJCR**-07S	LRIS-2.5*7	CLR-15S
Y-SDJCR**-11**	LRIS-4*10	LLR-25S-20*65

CH-SDUC

Screw-on toolholder with 93° approach angle, for positive 55° rhombic inserts, for horizontal gang style tool post

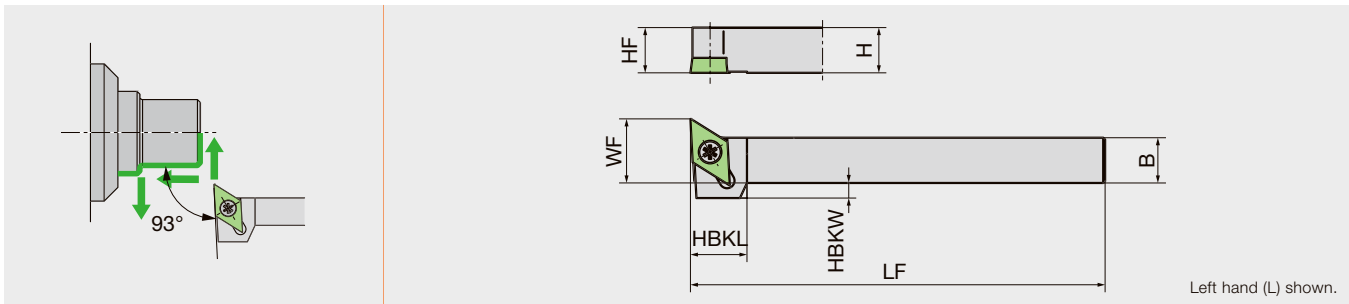

Designation	H	B	LF	HBKL	HBKW	HF	WF	Insert	
CH-SDUCL1010H11	10	10	100	15	6	10	15	DC..11T3..	DC..11T3..WP(TFD11..)
CH-SDUCL1212H11	12	12	100	15	4	12	17	DC..11T3..	DC..11T3..WP(TFD11..)
CH-SDUCL1616H11	16	16	100	-	-	16	21	DC..11T3..	DC..11T3..WP(TFD11..)
CH-SDUCL2020H11	20	20	100	-	-	20	25	DC..11T3..	DC..11T3..WP(TFD11..)

NOTE: Use a right-handed (R) or non-handed insert.

SPARE PARTS



Designation	Clamp screw	Wrench (for Clamp screw)
CH-SDUCL**H11	LRIS-4*12PW	CLR-15S

Reference pages : Inserts → 2-23 -, CBN → 2-91 -, PCD → 2-120 -

DC

Rhombic, 55°
with hole
Positive 7°

DS-SDU-ACH

Screw-on round-shank toolholder with 93° approach angle, for positive 55° rhombic inserts, with adjustable centerline height capability

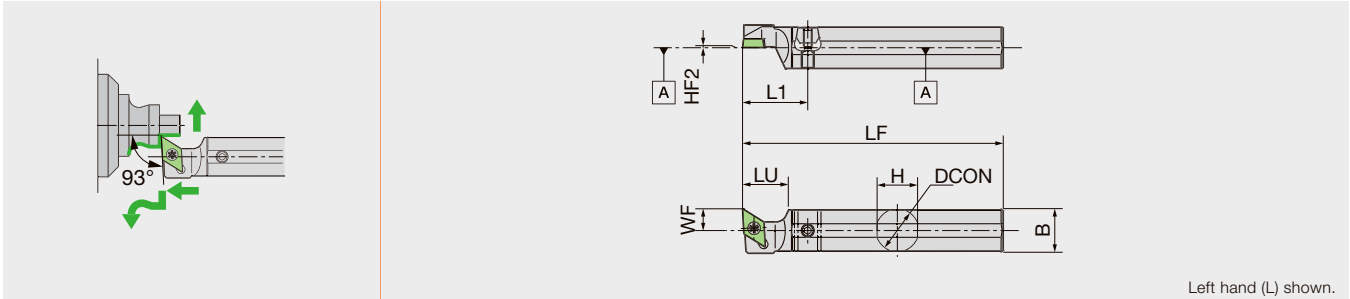

Designation	H	B	LF	DCON	HF2	LU	L1	WF	Insert
DS-SDUL16F-11-ACH	15.5	15.5	80	16	Type B(0~+0.3)	17	30	10	DC..11T3.. DC..11T3..WP(TFD11..)
DS-SDUL19-11-ACH	18	18	120	19.05	Type A(0~+0.2)	20	30	10	DC..11T3.. DC..11T3..WP(TFD11..)
DS-SDUL20-11-ACH	19	19	120	20	Type B(0~+0.3)	20	30	10	DC..11T3.. DC..11T3..WP(TFD11..)
DS-SDUL22-11-ACH	21	21	120	22	Type B(0~+0.3)	20	30	10	DC..11T3.. DC..11T3..WP(TFD11..)
DS-SDUL25-11-ACH	24	24	150	25.4	Type A(0~+0.2)	20	30	10	DC..11T3.. DC..11T3..WP(TFD11..)
DS-SDUL25-11MET-ACH	24	24	150	25	Type A(0~+0.2)	20	30	10	DC..11T3.. DC..11T3..WP(TFD11..)

SPARE PARTS



Designation	Clamp screw	Screw (for Wedge)	Wedge	Wrench (for Clamp screw)	Wrench (for Wedge)
DS-SDUL1**11-ACH	LRIS-4*10	WS060415-003	ACH-W18	LLR-25S-20*65	LW-3
DS-SDUL20-11-ACH	LRIS-4*10	WS060419-004	ACH-W18	LLR-25S-20*65	LW-3
DS-SDUL22-11-ACH	LRIS-4*10	WS060419-004	ACH-W18	LLR-25S-20*65	LW-3
DS-SDUL25-11**-ACH	LRIS-4*10	WS060419-004	ACH-W24	LLR-25S-20*65	LW-3

Screw-on round-shank toolholder with 93° approach angle, for positive 55° rhombic inserts

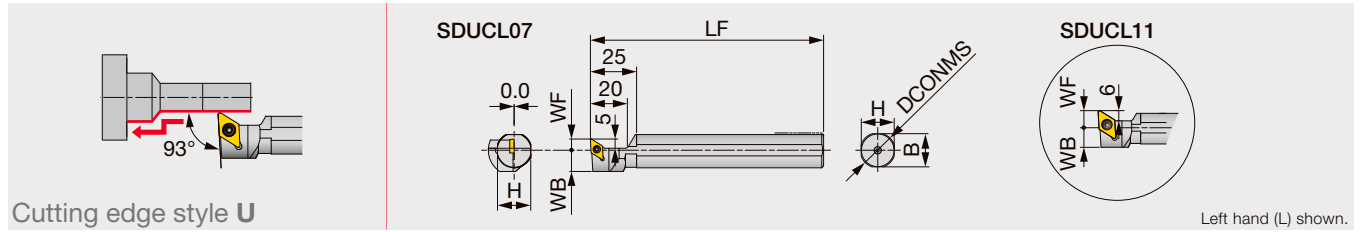

Cutting edge style **U**

Designation	DCONMS	WF	LF	H	B	WB	RE**	Insert	Torque*
JS19K-SDUCL07	19.05	6	125	18	18	11.5	0.4	DC**0702...	1.2
JS20K-SDUCL07	20	6	125	19	19	11.5	0.4	DC**0702...	1.2
JS22K-SDUCL07	22	6	125	21	21	11.5	0.4	DC**0702...	1.2
JS19K-SDUCL11	19.05	10	125	18	18	11.5	0.8	DC**11T3...	1.2
JS20K-SDUCL11	20	10	125	19	19	11.5	0.8	DC**11T3...	1.2
JS22K-SDUCL11	22	11	125	21	21	11.5	0.8	DC**11T3...	1.2
JS25K-SDUCL11	25	12	125	24	24	12.5	0.8	DC**11T3...	1.2
JS254K-SDUCL11	25.4	12	125	24	24	12.7	0.8	DC**11T3...	1.2

Torque*: Recommended clamping torque (N·m)
RE**: Standard corner radius

SPARE PARTS

Designation	Clamping screw	Wrench
JS**K-SDUCL07	CSTB-2.5	T-8F
JS**K-SDUCL11	CSTB-4SD	T-8F

DS-SDU

Screw-on round-shank toolholder with 93° approach angle, for positive 55° rhombic inserts

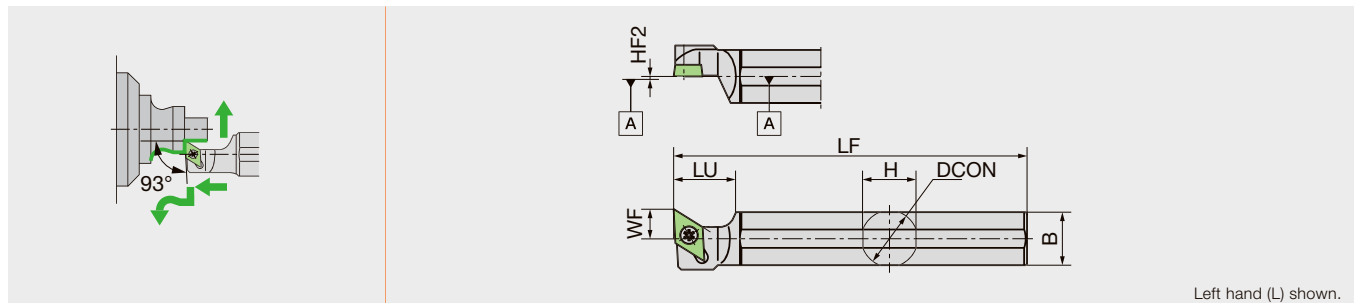

Designation	H	B	LF	DCON	HF2	LU	WF	Insert
DS-SDUL15H-07	15	15	100	15.875	0	20	6	DC..0702.. DC..0702..WP(TFD07..)
DS-SDUL16F-07	15	15	80	16	0	20	6	DC..0702.. DC..0702..WP(TFD07..)
DS-SDUL16F-11	15	15	80	16	0	20	10	DC..11T3.. DC..11T3..WP(TFD11..)
DS-SDUL16X-07	15	15	95	16	0	20	6	DC..0702.. DC..0702..WP(TFD07..)

NOTE: Use a right-handed (R) or non-handed insert.

SPARE PARTS

Designation	Clamp screw	Wrench (for Clamp screw)
DS-SDUL*-07	LRIS-2.5*7	CLR-15S
DS-SDUL16F-11	LRIS-4*10	LLR-25S-20*65

DC

 **Rhombic, 55°
with hole
Positive 7°**

MODUM^{INI}TURN QR12-SDUCL-CHP

Screw-on modular head with 93° approach angle, for positive 55° rhombic inserts, with high pressure coolant capability

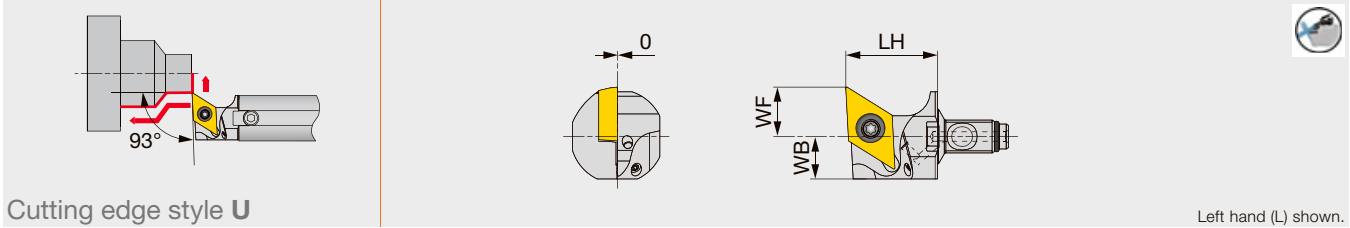

Designation	LH	WF	WB	RE**	Insert	Torque*	Shank
QR12C-SDUCL11-CHP	19.5	8.5	10.7	0.2	DC**11T3...	1.2	A16*-QR12
QR12D-SDUCL11-CHP	19.5	10.5	9	0.2	DC**11T3...	1.2	A19/20*-QR12

Torque*: Recommended clamping torque (N-m)
RE**: Standard corner radius
Assembled dimensions with shank are shown on page 9.

SPARE PARTS

Designation	Clamping screw	Wrench	O-ring
QR12*-SDUCL11-CHP	CSTB-4SD	T-8F	ORSS-0454.5X1.0NBR70

TUNG^{CAP} C-SDUCL-CHP

Screw-on toolholder, with 93° approach angle, for positive 55° rhombic inserts, with high pressure coolant capability

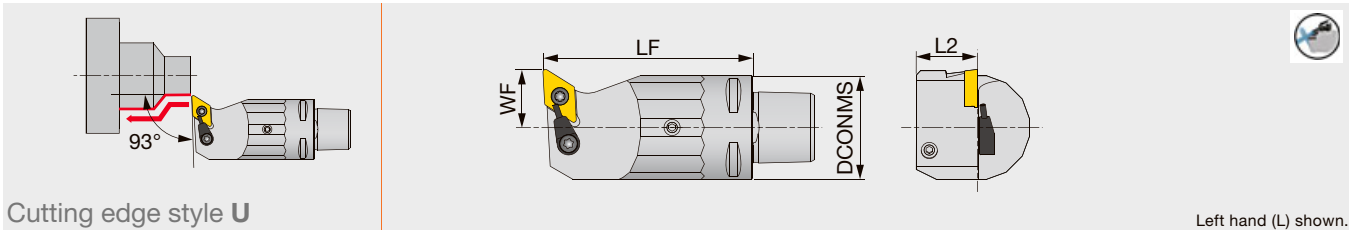

Designation	DCONMS	LF	L2	WF	RE	Insert
C3SDUCL18040-11-CHP	32	40	19	18	0.8	DC**11T3...
C3SDUCL18065-11-CHP	32	65	19	18	0.8	DC**11T3...

Applicable for 14 MPa coolant
Cannot be used for boring

SPARE PARTS

Designation	Clamping screw	Coolant unit	Wrench
C3SDUCL...	CSTB-4S	S-CU-CHP	T-15F

QR12-SDLCL-CHP

Screw-on modular head with 95° approach angle, for positive 55° rhombic inserts, with high pressure coolant capability

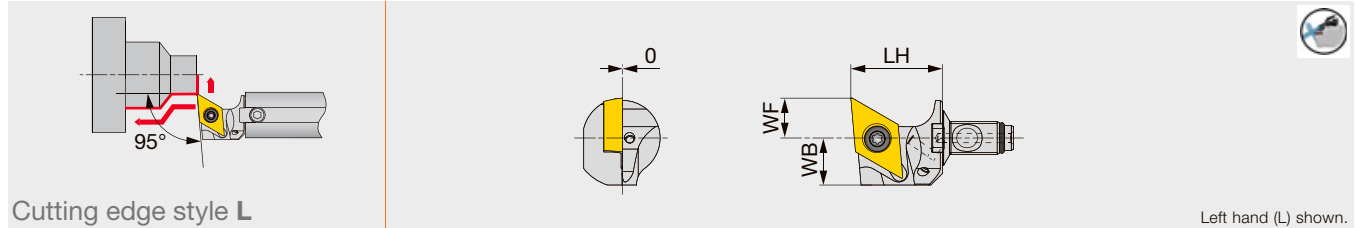

Cutting edge style L

Left hand (L) shown.

Designation	LH	WF	WB	RE**	Insert	Torque*	Shank
QR12C-SDLCL11-CHP	19.5	8.5	10	0.2	DC**11T3...	1.2	A16*-QR12
QR12D-SDLCL11-CHP	19.5	10.5	9	0.2	DC**11T3...	1.2	A19/20*-QR12

Torque*: Recommended clamping torque (N-m)

RE**: Standard corner radius

Assembled dimensions with shank are shown on page 9.

SPARE PARTS

Designation	Clamping screw	Wrench	O-ring
QR12*-SDLCL11-CHP	CSTB-4SD	T-8F	ORSS-0454.5X1.0NBR70

SDXC-N

Screw-on toolholder with 96° approach angle, for positive 55° rhombic inserts

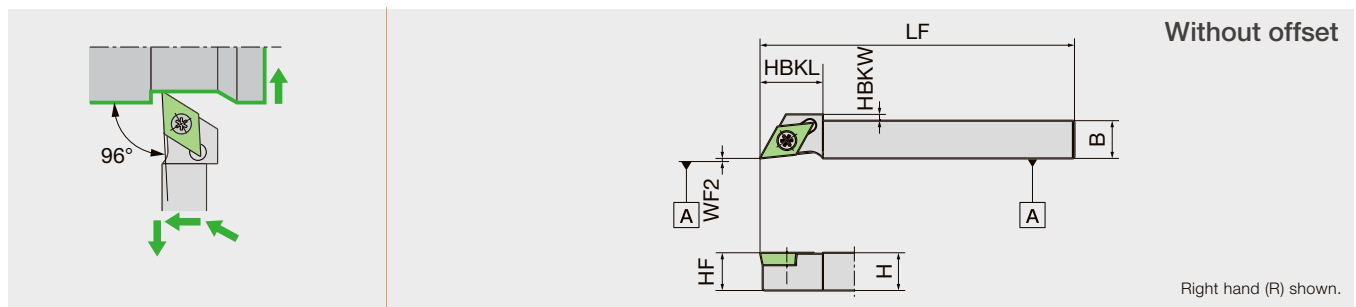

Without offset

Right hand (R) shown.

Designation	H	B	LF	HBKL	HBKW	HF	WF2	Insert
SDXCR1010X11N	10	10	120	20	3	10	0	DC..11T3..
SDXCR1212X11N	12	12	120	20	1	12	0	DC..11T3..
SDXCR1616X11N	16	16	120	-	-	16	0	DC..11T3..

NOTE: Use a right-handed (R) or non-handed insert.

SPARE PARTS

Designation	Clamp screw	Wrench (for Clamp screw)
SDXCR**X11N	LRIS-4*10	LLR-25S

DC

**Rhombic, 55°
with hole
Positive 7°**

DS-SDX

Screw-on round-shank toolholder with 96° approach angle, for positive 55° rhombic inserts

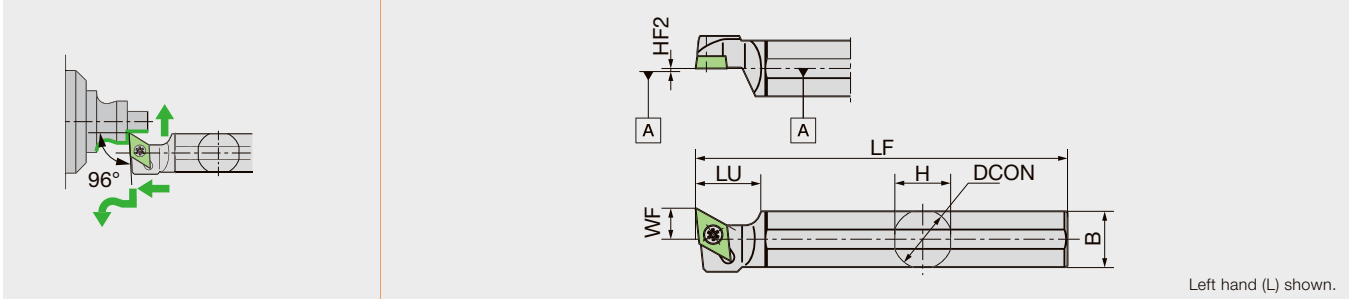

Designation	H	B	LF	DCON	HF2	LU	WF	Insert
DS-SDXL19-11	18	18	120	19.05	0	20	10	DC..11T3..
DS-SDXL20-11	19	19	120	20	0	20	10	DC..11T3..
DS-SDXL20X-11	19	19	95	20	0	20	10	DC..11T3..
DS-SDXL25-11MET	24	24	120	25	0	20	10	DC..11T3..
DS-SDXL32-11	30	30	150	32	0	20	10	DC..11T3..

NOTE: Use a right-handed (R) or non-handed insert.

SPARE PARTS

Designation	Clamp screw	Wrench (for Clamp screw)
DS-SDXL**	LRIS-4*10	LLR-25S

J-SERIES JSDNCN

Screw-on toolholder with 62.5° approach angle, for positive 55° rhombic inserts

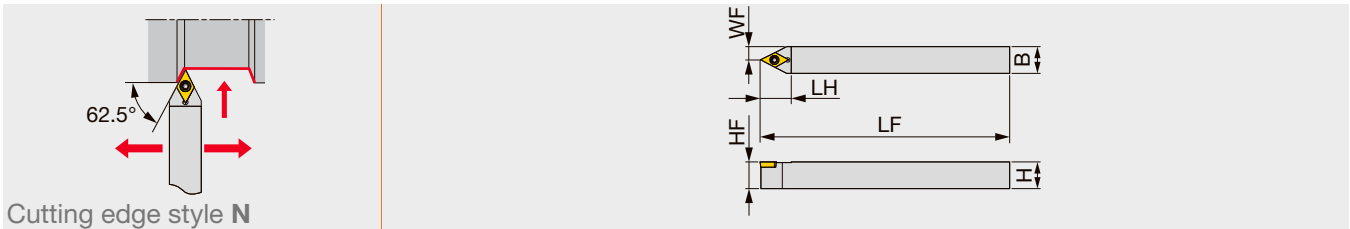

Designation	H	B	LF	LH	HF	WF	RE**	Insert	Torque*
JSDNCN1010X07	10	10	120	15	10	5	0.2	DC**0702...	1.2
JSDNCN1010X11	10	10	120	21	10	5	0.2	DC**11T3...	1.2
JSDNCN1212F07	12	12	85	15	12	6	0.2	DC**0702...	1.2
JSDNCN1212X07	12	12	120	15	12	6	0.2	DC**0702...	1.2
JSDNCN1212F11	12	12	85	21	12	6	0.2	DC**11T3...	1.2
JSDNCN1212X11	12	12	120	21	12	6	0.2	DC**11T3...	1.2
JSDNCN1616X11	16	16	120	21	16	8	0.2	DC**11T3...	1.2

Torque*: Recommended clamping torque (N-m)

RE**: Standard corner radius

SPARE PARTS

Designation	Clamping screw	Wrench 1	Wrench 2 (Optional)
JSDNCN**07	CSTB-2.5	T-8F	(T-8L)
JSDNCN**11	CSTB-4SD	T-8F	(T-8L)

Reference pages : Inserts → **2-23** -, CBN → **2-91** -, PCD → **2-120** -

SDNC

Screw-on toolholder with 62.5° approach angle, for positive 55° rhombic inserts

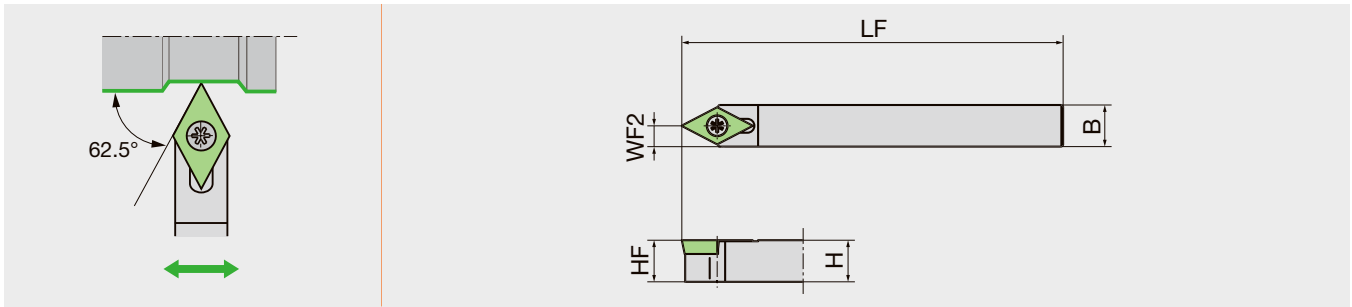

Designation	H	B	LF	HF	WF2	Insert
SDNCN08-X07	8	8	120	8	4	DC..0702..

SPARE PARTS



Designation	Clamp screw	Wrench (for Clamp screw)
SDNCN08-X07	LRIS-2.5*7	CLR-15S

Y-SDNC

Screw-on Y-axis turning toolholder with 62.5° approach angle, for positive 55° rhombic inserts

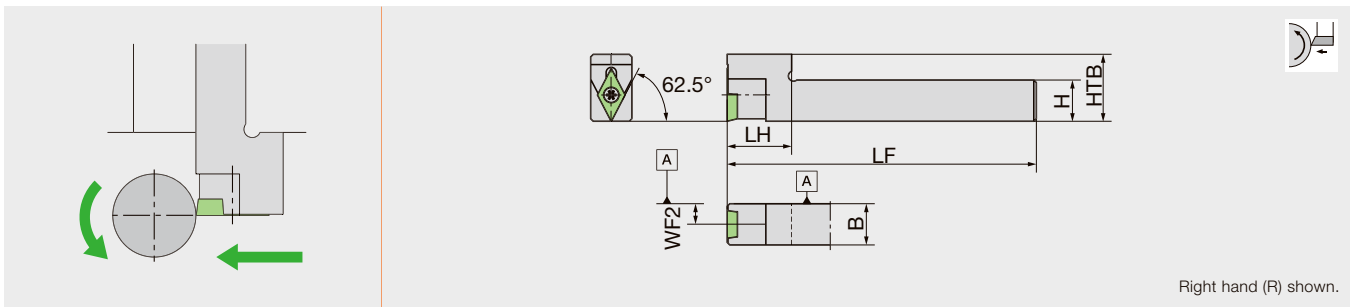

Designation	H	B	LF	LH	HTB	WF2	Insert
Y-SDNCN12-11S	12	12	120	20	21	6	DC..11T3..
Y-SDNCN16-11S	16	16	120	20	21	8	DC..11T3..

NOTE: There is a risk of interference with the Y-axis holder depending on the combination of the maximum workpiece diameter and machining diameter.
→10-1

SPARE PARTS



Designation	Clamp screw	Wrench (for Clamp screw)
Y-SDNCN*-11S	LRIS-4*10	LLR-25S-20*65

Reference pages : Inserts → 2-23 -, CBN → 2-91 -, PCD → 2-120 -

Grade 1
Insert 2
Ext. Toolholder 3
Int. Toolholder 4
Threading 5
Grooving 6
Shaper 7
Endmill 8
Drilling Tool 9
Technical Reference 10

DC

 Rhombic, 55°
with hole
Positive 7°

MODUM^{INI}TURN QR12-SDQCL-CHP

Screw-on modular head with 107.5° approach angle, for positive 55° rhombic inserts, with high pressure coolant capability

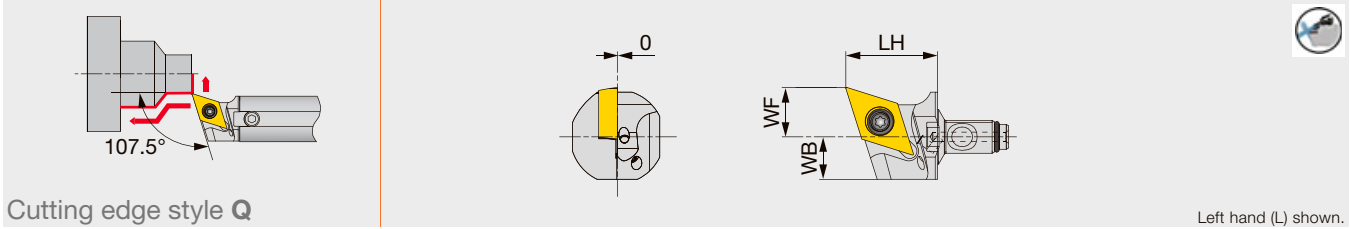

Designation	LH	WF	WB	RE**	Insert	Torque*	Shank
QR12C-SDQCL11-CHP	19.5	8.5	8	0.2	DC**11T3...	1.2	A16*-QR12
QR12D-SDQCL11-CHP	19.5	10.5	9	0.2	DC**11T3...	1.2	A19/20*-QR12

Torque*: Recommended clamping torque (N-m)
RE**: Standard corner radius
Assembled dimensions with shank are shown on page 9.

SPARE PARTS

Designation	Clamping screw	Wrench	O-ring
QR12*-SDQCL11-CHP	CSTB-4SD	T-8F	ORSS-0454.5X1.0NBR70

VB

 **Rhombic, 35°
with hole
Positive 5°**

MODUM^{INI}TURN

QC12-JSVJ2BR-CHP

Screw-on modular head with 93° approach angle, for positive 35° rhombic inserts, with high pressure coolant capability

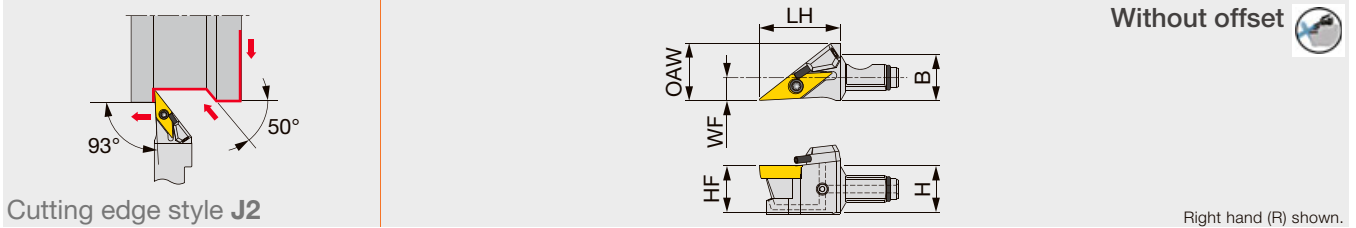

Designation	H	B	LH	HF	WF	OAW	RE**	Insert	Torque*
QC12-JSVJ2BR11-CHP	12	12	21	12	6	15	0.2	VB**1103...	1.2
QC16-JSVJ2BR11-CHP	16	16	21	16	8	20	0.2	VB**1103...	1.2

Torque*: Recommended clamping torque (N-m)
RE**: Standard corner radius

JSVJ2BR/L



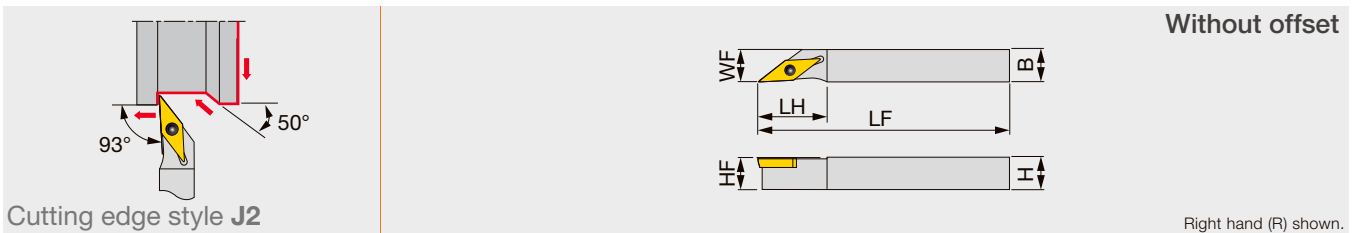

Screw-on toolholder with 93° approach angle, for positive 35° rhombic inserts



Designation	H	B	LF	LH	HF	WF	RE**	Insert	Torque*
JSVJ2BR/L1010X11	10	10	120	21	10	10	0.2	VB**1103...	1.2
JSVJ2BR/L1212F11	12	12	85	21	12	12	0.2	VB**1103...	1.2
JSVJ2BR/L1212X11	12	12	120	21	12	12	0.2	VB**1103...	1.2
JSVJ2BR/L1616X11	16	16	120	21	16	16	0.2	VB**1103...	1.2

Torque*: Recommended clamping torque (N-m)
RE**: Standard corner radius

SPARE PARTS

Designation	 Clamping screw	 Wrench 1	 O-ring	 Coolant nozzle	 Screw	 Wrench 2
QC12-JSVJ2BR11, JSVJ2BR/L...	CSTB-2.5	T-8F	-	-	-	-
QC12-JSVJ2BR11-CHP	CSTB-2.5	T-8F	ORSS-0454.5X1.0NBR70	NZ-1.10-7-CHP	SSHM4-4-TB	P-2
QC16-JSVJ2BR11-CHP	CSTB-2.5	T-8F	ORSS-0757.5X1.0NBR70	NZ-1.10-7-CHP	SSHM3-3	-

Reference pages : Inserts → 2-48 -, CBN → 2-99 -, PCD → 2-127, Shank, Accessory → 3-120

Grade 1
Insert 2
Ext. Toolholder 3
Int. Toolholder 4
Threading 5
Grooving 6
Shaper 7
Endmill 8
Drilling Tool 9
Technical Reference 10

VB



Rhombic, 35° with hole
Positive 5°

JSVJBR-F

Screw-on stepped-head toolholder with 93° approach angle, for positive 35° rhombic inserts

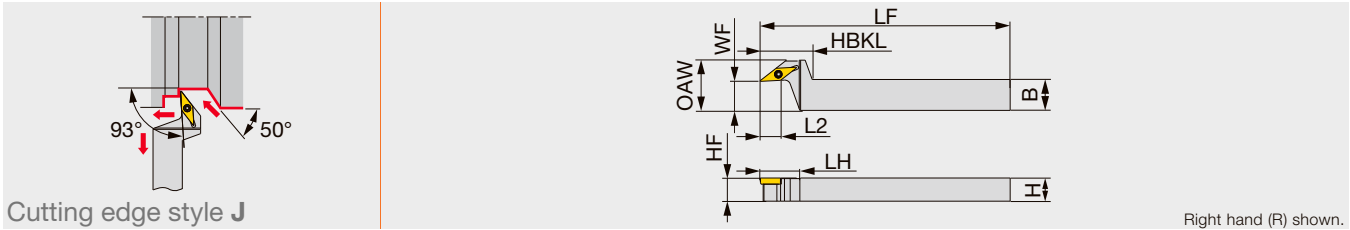

Designation	H	B	LF	L2	HBKL	LH	HF	WF	OAW	RE**	Insert	Torque*
JSVJBR1216F11-F15	12	16	85	12.6	27	21	12	15	26	0.2	VB**1103...	1.2
JSVJBR1216X11-F15	12	16	120	12.6	27	21	12	15	26	0.2	VB**1103...	1.2
JSVJBR1620X11-F15	16	20	120	12.6	27	21	16	15	26	0.2	VB**1103...	1.2

Torque*: Recommended clamping torque (N·m) RE**: Standard corner radius

JSVJBR/L

Screw-on toolholder with 93° approach angle, for positive 35° rhombic inserts

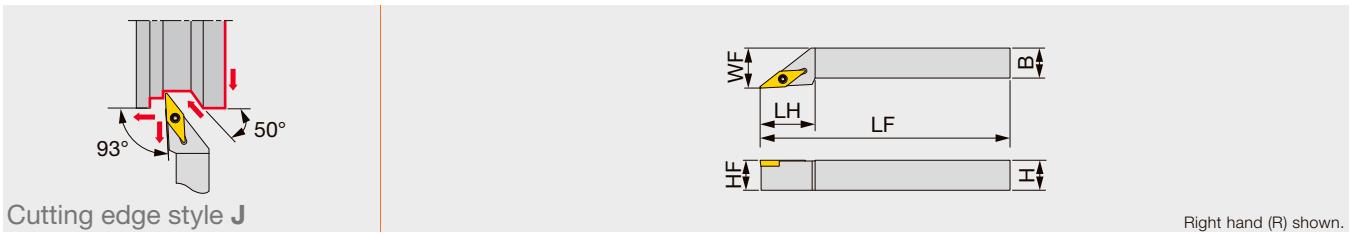

Designation	H	B	LF	LH	HF	WF	RE**	Insert	Torque*
JSVJBR/L1010H11	10	10	100	20	10	12	0.4	VB**1103...	1.2
JSVJBR/L1212H11	12	12	100	22	12	16	0.4	VB**1103...	1.2
JSVJBR/L1616H11	16	16	100	22	16	20	0.4	VB**1103...	1.2

Torque*: Recommended clamping torque (N·m) RE**: Standard corner radius

SPARE PARTS



Designation	Clamping screw	Wrench 1	Wrench 2 (Optional)
JSVJBR**-F15, JSVJBR/L...,	CSTB-2.5	T-8F	(T-8L)

QR12-SVUBL-CHP

Screw-on modular head with 93° approach angle, for positive 35° rhombic inserts, with high pressure coolant capability

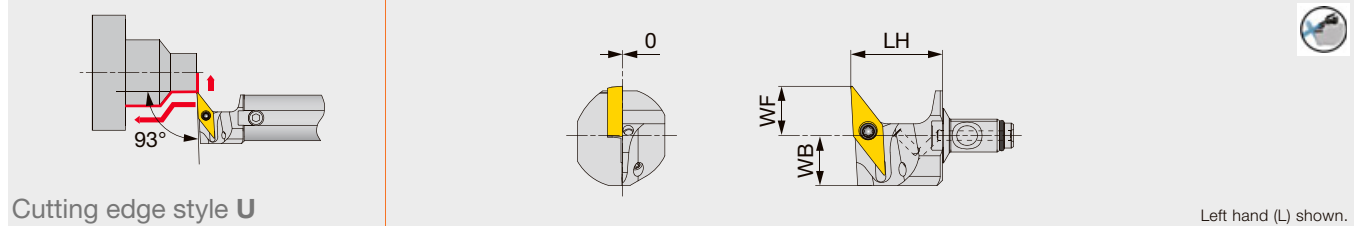

Designation	LH	WF	WB	RE**	Insert	Torque*	Shank
QR12C-SVUBL11-CHP	19.5	8.5	13	0.2	VB**1103...	1.2	A16*-QR12
QR12D-SVUBL11-CHP	19.5	10.5	10.6	0.2	VB**1103...	1.2	A19/20*-QR12

Torque*: Recommended clamping torque (N-m)
 RE**: Standard corner radius
 Assembled dimensions with shank are shown on page 9.

SPARE PARTS

Designation	Clamping screw	Wrench	O-ring
QR12*-SVUBL11-CHP	CSTB-2.5	T-8F	ORSS-0454.5X1.0NBR70

JSVNB

Screw-on toolholder with 72.5° approach angle, for positive 35° rhombic inserts

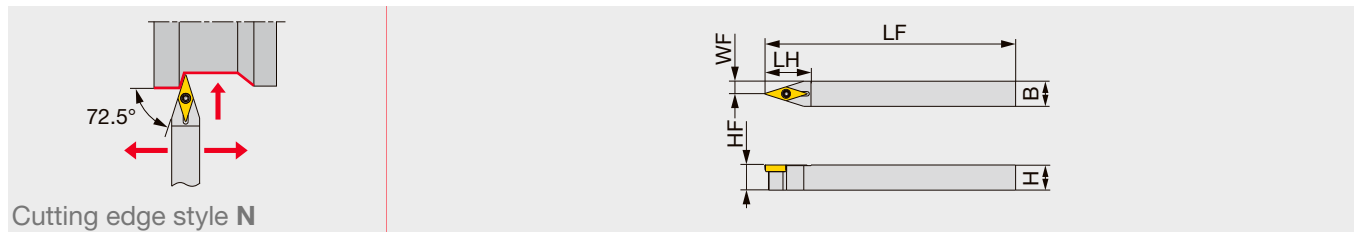

Designation	H	B	LF	LH	HF	WF	RE**	Insert	Torque*
JSVNB1010X11	10	10	120	22	10	5	0.2	VB**1103...	1.2
JSVNB1212F11	12	12	85	22	12	6	0.2	VB**1103...	1.2
JSVNB1212X11	12	12	120	22	12	6	0.2	VB**1103...	1.2
JSVNB1616X11	16	16	120	22	16	8	0.2	VB**1103...	1.2

Torque*: Recommended clamping torque (N-m)
 RE**: Standard corner radius

SPARE PARTS

Designation	Clamping screw	Wrench 1	Wrench 2 (Optional)
JSVNB...	CSTB-2.5	T-8F	(T-8L)

VC



Rhombic, 35° with hole
Positive 7°

SVJC-N-OH

Screw-on toolholder with 93° approach angle, for positive 35° rhombic inserts, with high pressure coolant capability

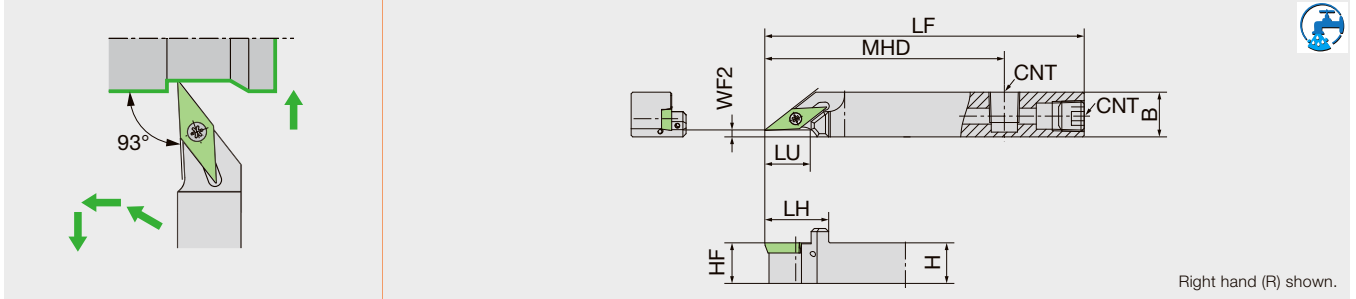

Designation	H	B	LF	LH	HF	LU	MHD	WF2	CNT	Insert
SVJCR1014F11N-F02OH	10	14	80	21	10	18	55	2	M6*1	VC..1103.. VC..1103..WP(TFV11..)
SVJCR1214H11N-F02OH	12	14	100	21	12	18	75	2	Rc1/8	VC..1103.. VC..1103..WP(TFV11..)
SVJCR1616H11N-F02OH	16	16	100	21	16	18	75	2	Rc1/8	VC..1103.. VC..1103..WP(TFV11..)

SPARE PARTS



Designation	Clamp screw	Screw (for CNT)	Wrench (for Clamp screw)	Wrench (for CNT)
SVJCR1014F11N-F02OH	LRIS-2.5*7	SS0605SC	CLR-15S	LW-3
SVJCR1214H11N-F02OH	LRIS-2.5*7	SPR1/8	CLR-15S	-
SVJCR1616H11N-F02OH	LRIS-2.5*7	SPR1/8	CLR-15S	-

SVJC-N

Screw-on toolholder with 93° approach angle, for positive 35° rhombic inserts

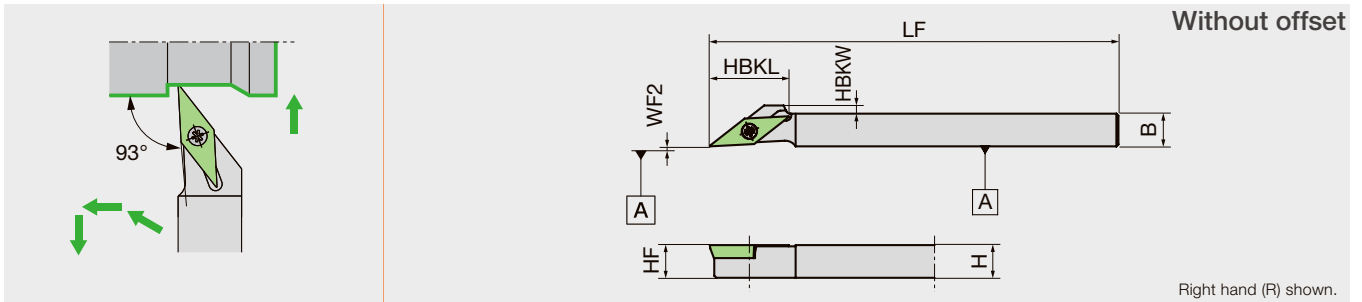

Designation	H	B	LF	HBKL	HBKW	HF	WF2	Insert
SVJCR0808H11N	8	8	100	19	2	8	0	VC..1103.. VC..1103..WP(TFV11..)
SVJCR1010X11N	10	10	120	-	-	10	0	VC..1103.. VC..1103..WP(TFV11..)
SVJCR1212X11N	12	12	120	-	-	12	0	VC..1103.. VC..1103..WP(TFV11..)
SVJCR1616X11N	16	16	120	-	-	16	0	VC..1103.. VC..1103..WP(TFV11..)
SVJCL1010X11N	10	10	120	-	-	10	0	VC..1103.. VC..1103..WP(TFV11..)
SVJCL1212X11N	12	12	120	-	-	12	0	VC..1103.. VC..1103..WP(TFV11..)
SVJCL1616X11N	16	16	120	-	-	16	0	VC..1103.. VC..1103..WP(TFV11..)

SPARE PARTS



Designation	Clamp screw	Wrench (for Clamp screw)
SVJCR**11N	LRIS-2.5*7	CLR-15S

Reference pages : Inserts → 2-50 -, CBN → 2-101, PCD → 2-127

Screw-on toolholder with 93° approach angle, for positive 35° rhombic inserts

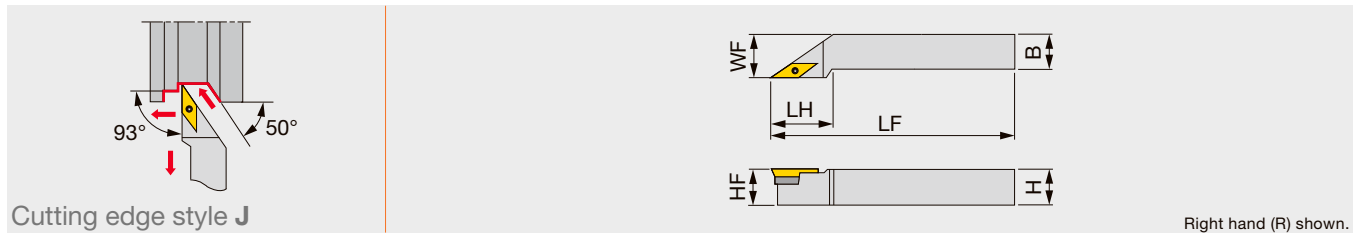

Designation	H	B	LF	LH	HF	WF	RE**	Insert
SVJCR/L1616H16	16	16	100	32	16	20	0.8	VC**1604...
SVJCR/L2020K16	20	20	125	32	20	25	0.8	VC**1604...

**RE: Standard corner radius

SPARE PARTS

Designation	Clamping screw	Shim	Shim screw	Wrench 1	Wrench 2
SVJCR/L...	CSTB-3.5L	SSV32	DTS5-3.5	P-3.5	T-15F

Y-SVJC-OH

Screw-on Y-axis turning toolholder with 93° approach angle, for positive 35° rhombic inserts, with high pressure coolant capability

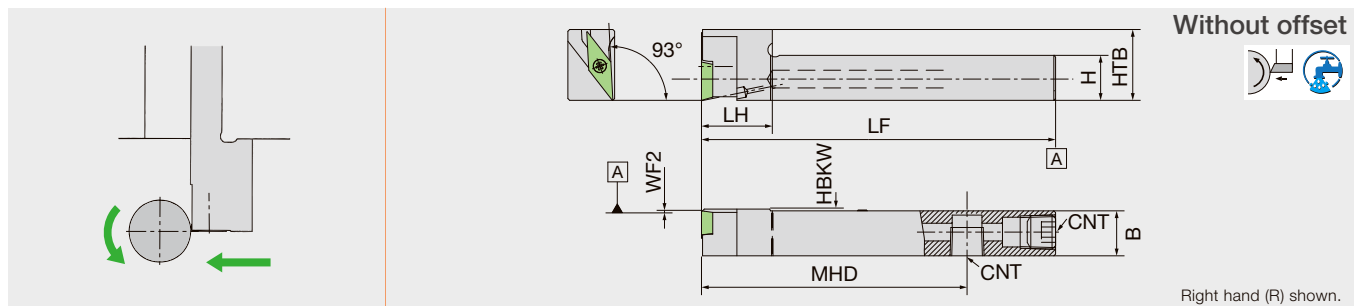

Designation	H	B	LF	LH	HBKW	HTB	MHD	WF2	CNT	Insert
Y-SVJCR1212H11S-OH	12	12	100	20	0.5	20	75	0	Rc1/8	VC..1103.. VC..1103..WP(TFV11..)
Y-SVJCR1616H11S-OH	16	16	100	20	0.5	20	75	0	Rc1/8	VC..1103.. VC..1103..WP(TFV11..)

NOTE: Use a right-handed (R) or non-handed insert.

NOTE: There is a risk of interference with the Y-axis holder depending on the combination of the maximum workpiece diameter and machining diameter.

→A012

SPARE PARTS

Designation	Clamp screw	Screw (for CNT)	Wrench (for Clamp screw)
Y-SVJCR**H11S-OH	LRIS-2.5*7	SPR1/8	CLR-15S

VC

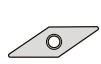

Rhombic, 35° with hole
Positive 7°

CH-SVUC

Screw-on toolholder with 93° approach angle, for positive 35° rhombic inserts, for horizontal gang style tool post

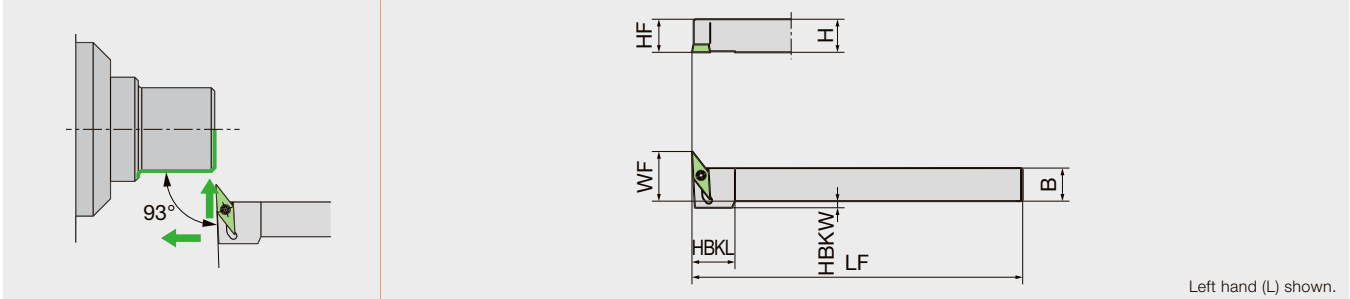

Left hand (L) shown.

Designation	H	B	LF	HBKL	HBKW	HF	KAPR	WF	Insert
CH-SVUCL1010H11	10	10	100	15	2	10	3°	18	VC..1103.. VC..1103..WP(TFV11..)
CH-SVUCL1212H11	12	12	100	-	-	12	3°	20	VC..1103.. VC..1103..WP(TFV11..)
CH-SVUCL1616H11	16	16	100	-	-	16	3°	24	VC..1103.. VC..1103..WP(TFV11..)
CH-SVUCL2020H11	20	20	100	-	-	20	3°	28	VC..1103.. VC..1103..WP(TFV11..)

NOTE: Use a right-handed (R) or non-handed insert.

SPARE PARTS



Designation	Clamp screw	Wrench (for Clamp screw)
CH-SVUCL**H11	LRIS-2.5*7	CLR-15S

TUNG CAP

C-SVUCL-CHP

Screw-on toolholder, with 93° approach angle, for positive 35° rhombic inserts, with high pressure coolant capability

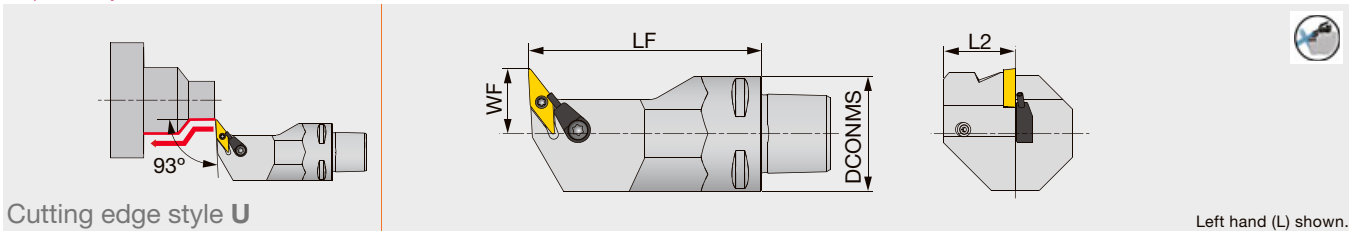

Left hand (L) shown.

Designation	DCONMS	LF	L2	WF	RE	Insert
C3SVUCL18065-11-CHP	32	65	20	18	0.4	VC**1103...

Applicable for 14 MPa coolant
Cannot be used for boring

SPARE PARTS



Designation	Clamping screw	Coolant unit	Wrench
C3SVUCL18065-11-CHP	CSTB-2.5	S-CU-CHP	T-8F

Reference pages : Inserts → 2-50 -, CBN → 2-101, PCD → 2-127

Y-SVXC

Screw-on Y-axis turning toolholder with 95° approach angle, for positive 35° rhombic inserts

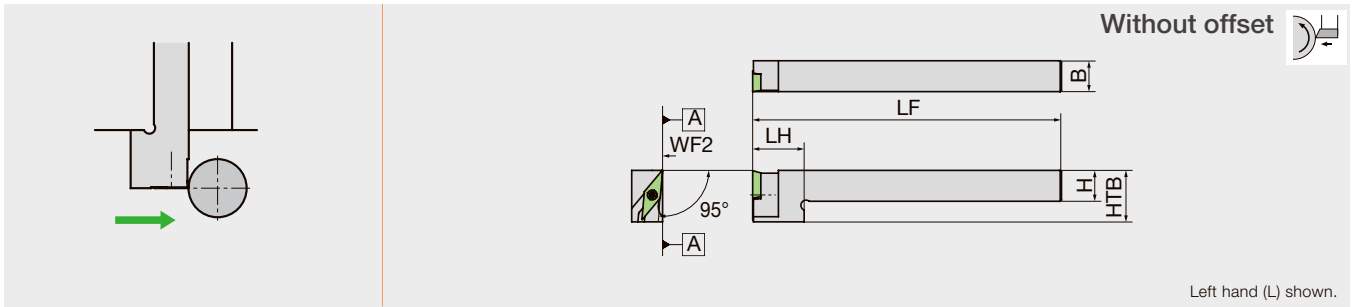

Designation	H	B	LF	LH	WF2	Insert
Y-SVXCL12-11S	12	12	120	20	0	VC..1103..

NOTE: Use a left-handed (L) or non-handed insert.

NOTE: There is a risk of interference with the Y-axis holder depending on the combination of the maximum workpiece diameter and machining diameter.

→A012

SPARE PARTS



Designation	Clamp screw	Wrench (for Clamp screw)
SVACR1010L13NW	LRIS-3*8	RLR-20S

SVXC-N

Screw-on toolholder with 99° approach angle, for positive 35° rhombic inserts

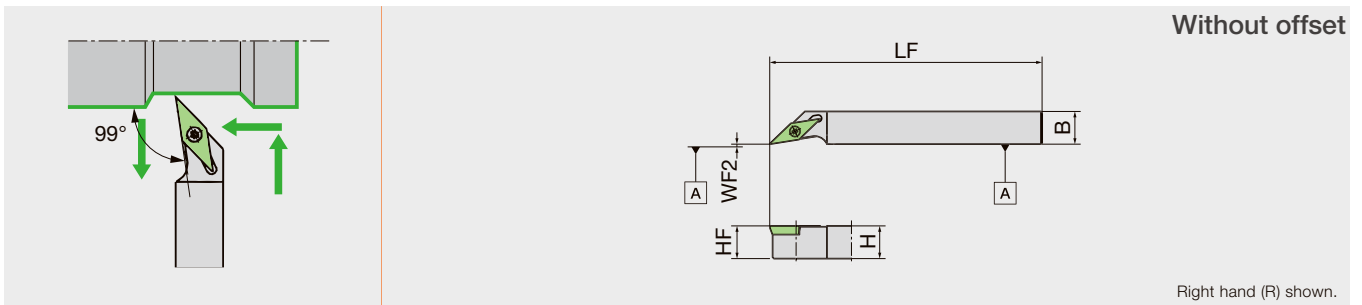

Designation	H	B	LF	HF	WF2	Insert
SVXCR1012X11N	10	12	120	10	0	VC..1103..
SVXCR1212X11N	12	12	120	12	0	VC..1103..
SVXCL1012X11N	10	12	120	10	0	VC..1103..

SPARE PARTS



Designation	Clamp screw	Wrench (for Clamp screw)
SVXCR**X11N	LRIS-2.5*7	CLR-15S

VC



Rhombic, 35° with hole
Positive 7°

DS-SVX

Screw-on round-shank toolholder with 99° approach angle, for positive 35° rhombic inserts

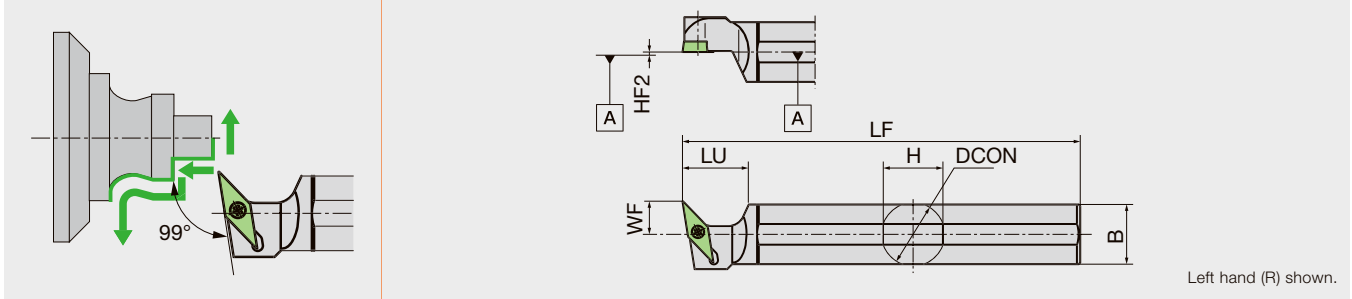

Designation	H	B	LF	DCON	HF2	LU	WF	Insert
DS-SVXL15H-11	15	15	100	15.875	0	20.5	10	VC..1103..
DS-SVXL16F-11	15	15	80	16	0	20.5	10	VC..1103..
DS-SVXL19-11	18	18	120	19.05	0	20	10	VC..1103..
DS-SVXL19-11SPL	18	18	160	19.05	0	20	11	VC..1103..
DS-SVXL20-11	19	19	120	20	0	20	10	VC..1103..
DS-SVXL20X-11	19	19	95	20	0	20	10	VC..1103..
DS-SVXL22-11	21	21	120	22	0	20	10	VC..1103..
DS-SVXL25-11	24	24	150	25.4	0	20	10	VC..1103..
DS-SVXL25-11MET	24	24	150	25	0	20	10	VC..1103..

NOTE: Use a right-handed (R) or non-handed insert.

SPARE PARTS



Designation	Clamp screw	Wrench (for Clamp screw)
DS-SVXL**	LRIS-2.5*7	CLR-15S

SVVC-N

Screw-on toolholder with 72.5° approach angle, for positive 35° rhombic inserts

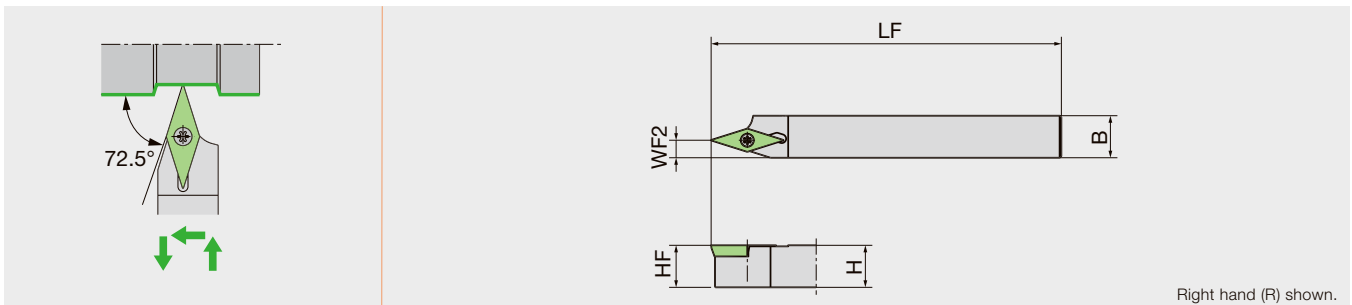

Designation	H	B	LF	HF	WF2	Insert
SVVCR1212X11N	12	12	120	12	5	VC..1103..
SVVCR1616X11N	16	16	120	16	5	VC..1103..

SPARE PARTS



Designation	Clamp screw	Wrench (for Clamp screw)
SVVCR**	LRIS-2.5*7	CLR-15S

Reference pages : Inserts → **2-50** -, CBN → **2-101**, PCD → **2-127**

SVVCN

Screw-on toolholder with 72.5° approach angle, for positive 35° rhombic inserts

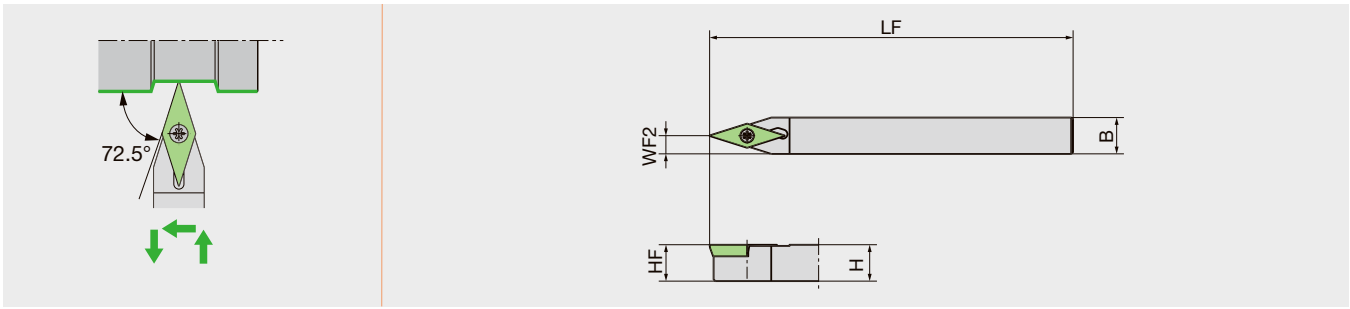

Designation	H	B	LF	HF	WF2	Insert
SVVCN0808H11N	8	8	100	8	4	VC..1103..
SVVCN1010X11N	10	10	120	10	5	VC..1103..
SVVCN20-X11	20	20	120	20	10	VC..1103..

SPARE PARTS



Designation	Clamp screw	Wrench (for Clamp screw)
SVVCN**	LRIS-2.5*7	CLR-15S

- Grade 1
- Insert 2
- Ext. Toolholder 3
- Int. Toolholder 4
- Threading 5
- Grooving 6
- Shaper 7
- Endmill 8
- Drilling Tool 9
- Technical Reference 10

VP

Rhombic, 35°
with hole
Positive 11°

J-SERIES

JSVL2PR/L

Screw-on toolholder with 95° approach angle, for positive 35° rhombic inserts

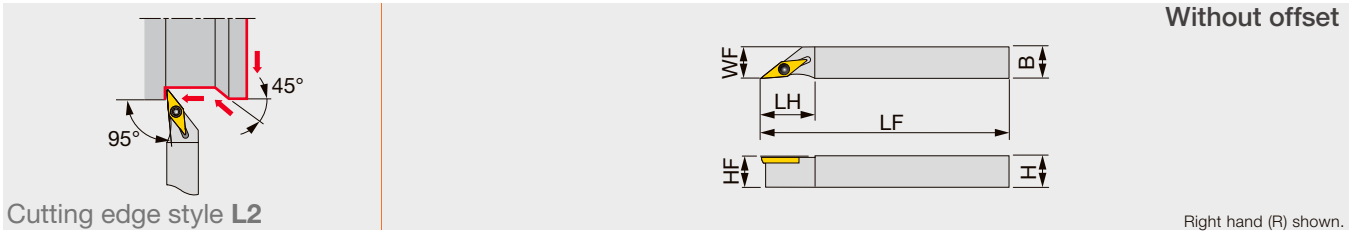

Designation	H	B	LF	LH	HF	WF	RE**	Insert	Torque*
JSVL2PR/L1010X08	10	10	120	16	10	10	0.2	VP**0802...	0.6
JSVL2PR/L1010K08	10	10	125	16	10	10	0.2	VP**0802...	0.6
JSVL2PR/L1212F08	12	12	85	16	12	12	0.2	VP**0802...	0.6
JSVL2PR/L1212F11	12	12	85	21	12	12	0.2	VP**1103...	1.2
JSVL2PR/L1212X08	12	12	120	16	12	12	0.2	VP**0802...	0.6
JSVL2PR/L1212X11	12	12	120	21	12	12	0.2	VP**1103...	1.2
JSVL2PR/L1212K08	12	12	125	16	12	12	0.2	VP**0802...	0.6
JSVL2PR/L1616X08	16	16	120	16	16	16	0.2	VP**0802...	0.6
JSVL2PL1616K08	16	16	125	16	16	16	0.2	VP**0802...	0.6
JSVL2PR/L1616X11	16	16	120	21	16	16	0.2	VP**1103...	1.2

Torque*: Recommended clamping torque (N-m)
RE**: Standard corner radius

SPARE PARTS

Designation	Clamping screw	Wrench 1	Wrench 2 (Optional)
JSVL2PR/L**08	CSTB-2L	T-6F	(T-6L)
JSVL2PR/L**11	CSTB-2.5	T-8F	(T-8L)

JSVP2PR/L

Screw-on toolholder with 117.5° approach angle, for positive 35° rhombic inserts

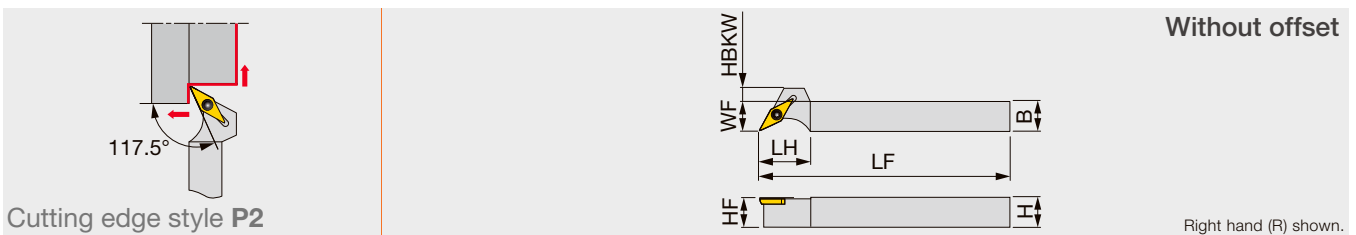

Designation	H	B	LF	LH	HF	WF	HBKW	RE**	Insert	Torque*
JSVP2PR/L1010K08	10	10	125	16	10	10	4	0.2	VP**0802...	0.6
JSVP2PR/L1010K11	10	10	125	20	10	10	8	0.2	VP**1103...	1.2
JSVP2PR/L1212K08	12	12	125	16	12	12	2	0.2	VP**0802...	0.6
JSVP2PR/L1212K11	12	12	125	20	12	12	6	0.2	VP**1103...	1.2
JSVP2PR/L1616K08	16	16	125	16	16	16	2	0.2	VP**0802...	0.6
JSVP2PR/L1616K11	16	16	125	20	16	16	6	0.2	VP**1103...	1.2

Torque*: Recommended clamping torque (N-m)
RE**: Standard corner radius

SPARE PARTS

Designation	Clamping screw	Wrench 1	Wrench 2 (Optional)
JSVP2PR/L**08	CSTB-2L	T-6F	(T-6L)
JSVP2PR/L**11	CSTB-2.5	T-8F	(T-8L)

Reference pages : Inserts → 2-54 -

SVXP-N

Screw-on toolholder with 99° approach angle, for positive 35° rhombic inserts

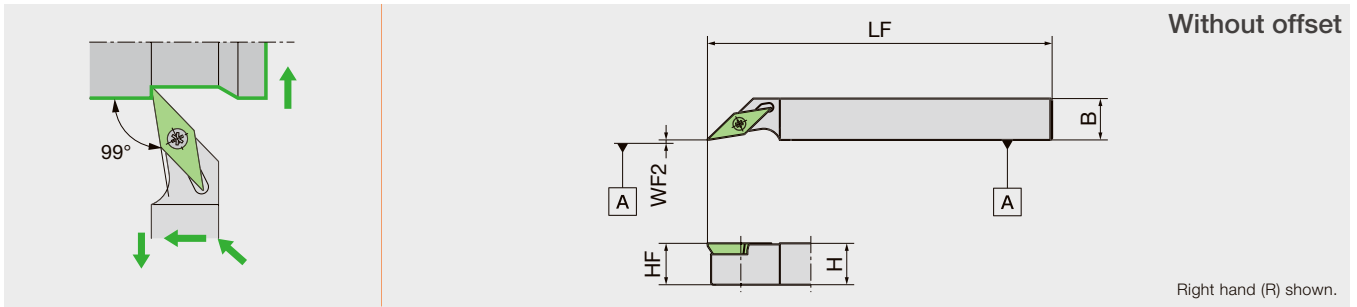

Designation	H	B	LF	HF	WF2	Insert
SVXPR1012X11N	10	12	120	10	0	VP..1103..
SVXPR1212X11N	12	12	120	12	0	VP..1103..
SVXPL1012X11N	10	12	120	10	0	VP..1103..
SVXPL1212X11N	12	12	120	12	0	VP..1103..

SPARE PARTS



Designation	Clamp screw	Wrench (for Clamp screw)
SVXPR**X11N	LRIS-2.5*7	CLR-15S

DS-SVXP

Screw-on round-shank toolholder with 99° approach angle, for positive 35° rhombic inserts

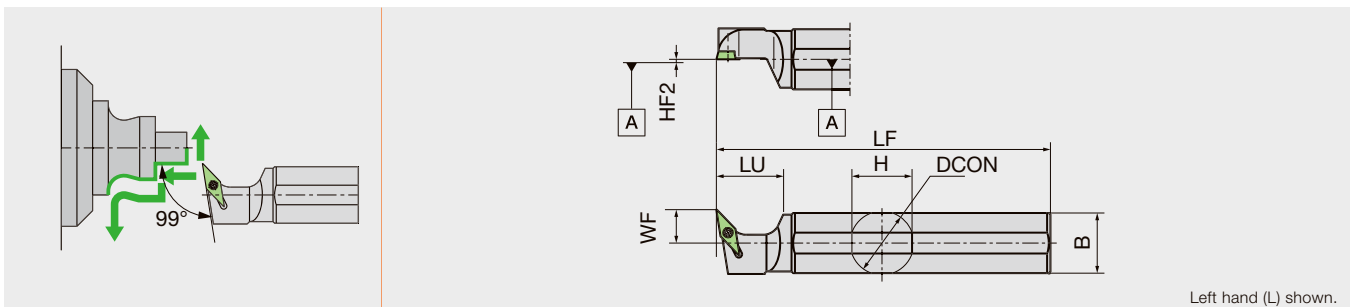

Designation	H	B	LF	DCON	HF2	LU	WF	Insert
DS-SVXPL19-08	18	18	120	19.05	0	20	10	VP..0802..
DS-SVXPL20-08	19	19	120	20	0	20	10	VP..0802..
DS-SVXPL22-08	21	21	120	22	0	20	10	VP..0802..
DS-SVXPL25-08	24	24	150	25.4	0	20	10	VP..0802..

NOTE: Use a right-handed (R) or non-handed insert.

SPARE PARTS



Designation	Clamp screw	Wrench (for Clamp screw)
DS-SVXPL**-08	LRIS-2*6	CLR-13S

Reference pages : Inserts → 2-54 -

Grade 1
Insert 2
Ext. Toolholder 3
Int. Toolholder 4
Threading 5
Grooving 6
Shaper 7
Endmill 8
Drilling Tool 9
Technical Reference 10

VP

 **Rhombic, 35° with hole**
Positive 11°

CH-SVUP

Screw-on toolholder with 93° approach angle, for positive 35° rhombic inserts, for horizontal gang style tool post

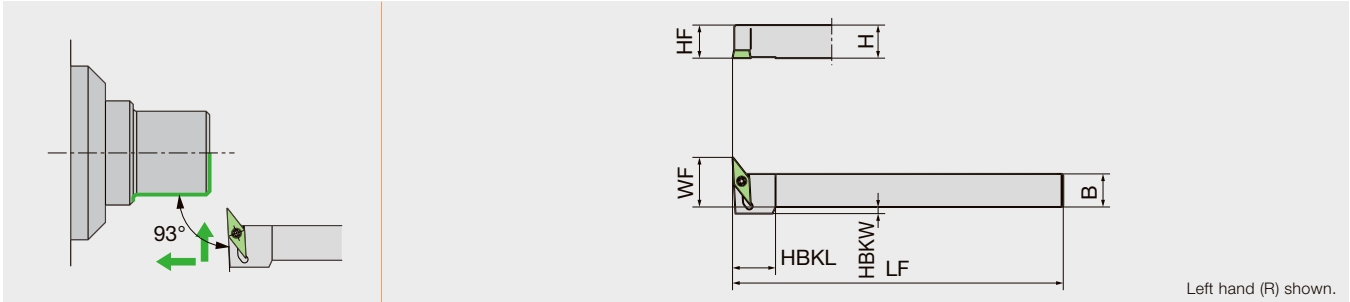

Designation	H	B	LF	HBKL	HBKW	HF	WF	Insert
CH-SVUPL1010H08	10	10	100	13	2	10	15	VP..0802..
CH-SVUPL1212H08	12	12	100	-	-	12	17	VP..0802..

NOTE: Use a right-handed (R) or non-handed insert.

SPARE PARTS



Designation	Clamp screw	Wrench (for Clamp screw)
CH-SVUPL**H08	LRIS-2*6	CLR-13S

DS-SVVPN-ACH

Screw-on round-shank toolholder with 72.5° approach angle, for positive 35° rhombic inserts, with adjustable centerline height capability

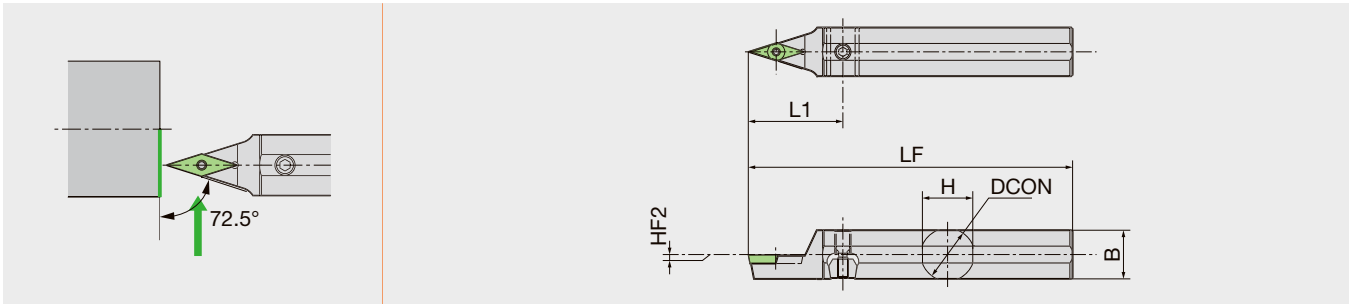

Designation	H	B	LF	DCON	HF2	L1	Insert
DS-SVVPN16-11-ACH	15.5	15	120	16	Type B(0~+0.3)	31	VP..1103..
DS-SVVPN19-11-ACH	18	18	120	19.05	Type B(0~+0.3)	35	VP..1103..
DS-SVVPN20-11-ACH	19	19	120	20	Type B(0~+0.3)	35	VP..1103..
DS-SVVPN22-11-ACH	21	21	120	22	Type A(0~+0.2)	35	VP..1103..
DS-SVVPN25-11-ACH	24	24	150	25.4	Type A(0~+0.2)	35	VP..1103..

SPARE PARTS



Designation	Clamp screw	Screw (for Wedge)	Wedge	Wrench (for Clamp screw)	Wrench (for Wedge)
DS-SVVPN16-11-ACH	LRIS-2.5*7	WS060415-003	ACH-W18	CLR-15S	LW-3
DS-SVVPN19-11-ACH	LRIS-2.5*7	WS060415-003	ACH-W18	CLR-15S	LW-3
DS-SVVPN20-11-ACH	LRIS-2.5*7	WS060419-004	ACH-W18	CLR-15S	LW-3
DS-SVVPN22-11-ACH	LRIS-2.5*7	WS060419-004	ACH-W18	CLR-15S	LW-3
DS-SVVPN25-11-ACH	LRIS-2.5*7	WS060419-004	ACH-W24	CLR-15S	LW-3

Reference pages : Inserts → [2-54](#) -



JSTACR/L

Screw-on toolholder with 91° approach angle, for positive 60° triangular inserts

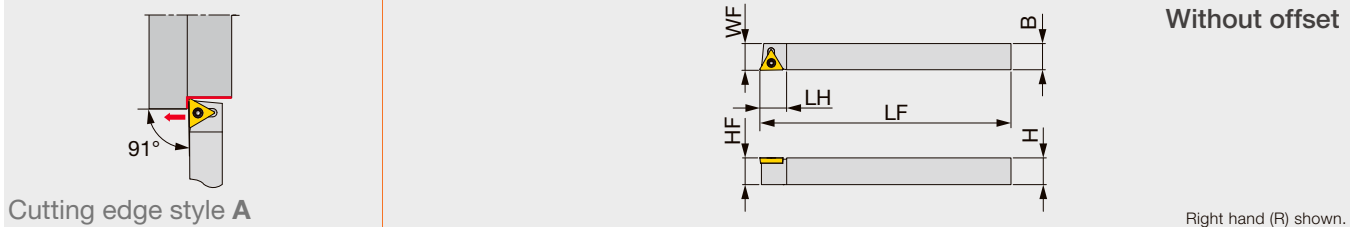

Designation	H	B	LF	LH	HF	WF	RE**	Insert	Torque*
JSTACR/L0808K08	8	8	125	10	8	8	0.2	TC**0802...	0.6
JSTACR/L1010K08	10	10	125	10	10	10	0.2	TC**0802...	0.6
JSTACR/L1212K11	12	12	125	12	12	12	0.4	TC**1102...	1.2
JSTACR/L1616H11	16	16	100	12	16	16	0.4	TC**1102...	1.2

Torque*: Recommended clamping torque (N·m) RE**: Standard corner radius

SPARE PARTS



Designation	Clamping screw	Wrench 1	Wrench 2 (Optional)
JSTACR/L**K08	CSTB-2L	T-6F	(T-6L)
JSTACR/L**11	CSTB-2.5	T-8F	(T-8L)

CH-STUC

Screw-on toolholder with 93° approach angle, for positive 60° rhombic inserts, for horizontal gang style tool post

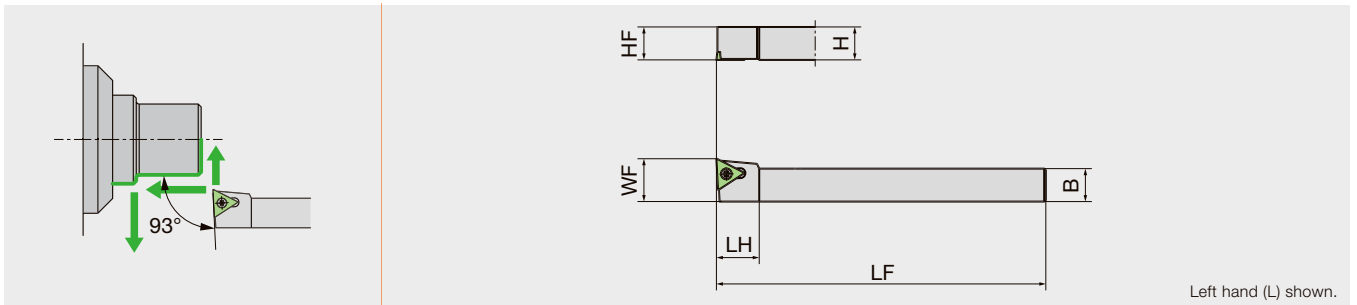

Designation	H	B	LF	LH	HF	WF	Insert
CH-STUCL1010H09	10	10	100	13	10	13	TC..0902..
CH-STUCL1212H09	12	12	100	13	12	15	TC..0902..

NOTE: Use a right-handed (R) or non-handed insert.

SPARE PARTS



Designation	Clamp screw	Wrench (for Clamp screw)
CH-STUCL**H09	LRIS-2.2*6	CLR-13S

WX



**Trigon, 80°
with hole**

MINIFORCE QC12-JSWL2XR-Y-CHP

Screw-on Y-axis turning modular head with 95° approach angle, for WXGU inserts, with high pressure coolant capability

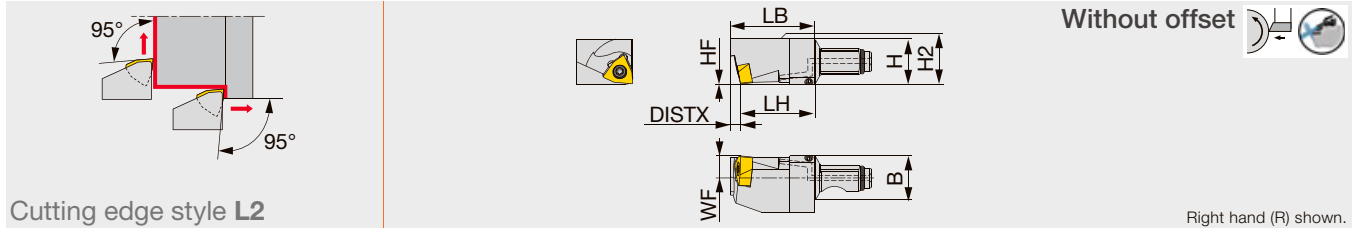

Designation	H	B	LH	HF	WF	LB	H2	DISTX	RE**	Insert	Torque*
QC12-JSWL2XR04-Y-CHP	12	12	19.5	0	6	22.3	12	2.8	0.2	WXGU0403**L...	0.9
QC16-JSWL2XR04-Y-CHP	16	16	21	0	8	23.8	16	2.8	0.2	WXGU0403**L...	0.9

Torque*: Recommended clamping torque (N-m)
RE**: Standard corner radius
Use right-hand toolholders (R) with left-hand inserts (L).

SPARE PARTS

Designation	Clamping screw	Wrench	O-ring
QC12-JSWL2XR04-Y-CHP	SR34-514	T-7F	ORSS-0454.5X1.0NBR70
QC16-JSWL2XR04-Y-CHP	SR34-514	T-7F	ORSS-0757.5X1.0NBR70

QC12-JSWL2XR-CHP

Screw-on modular head with 95° approach angle, for WXGU inserts, with high pressure coolant capability

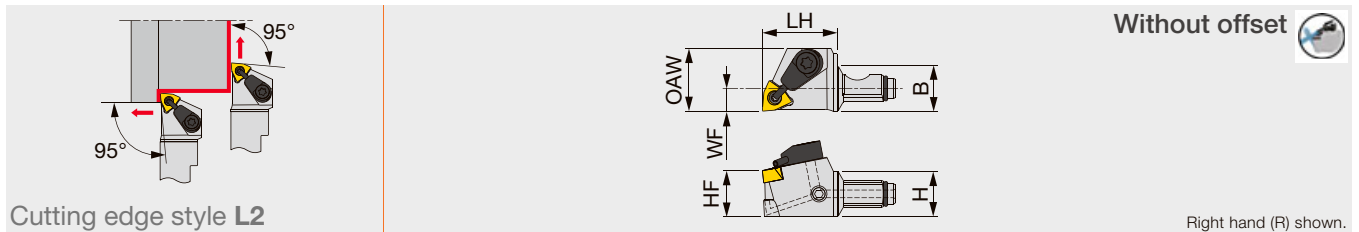

Designation	H	B	LH	HF	WF	OAW	RE**	Insert	Torque*
QC10-JSWL2XR04-CHP	10	10	17	10	5	13	0.2	WXGU0403**L...	0.9
QC12-JSWL2XR04-CHP	12	12	19.5	12	6	16.5	0.2	WXGU0403**L...	0.9
QC16-JSWL2XR04-CHP	16	16	21	16	8	20	0.2	WXGU0403**L...	0.9

Torque*: Recommended clamping torque (N-m)
RE**: Standard corner radius
Use right-hand toolholders (R) with left-hand inserts (L).

SPARE PARTS

Designation	Clamping screw 1	Coolant unit	Wrench 1	O-ring
QC10-JSWL2XR04-CHP	SR34-514	-	T-7F	ORSS-0353.5X1.0NBR70
QC12-JSWL2XR04-CHP	SR34-514	S-CU-CHP	T-7F	ORSS-0454.5X1.0NBR70
QC16-JSWL2XR04-CHP	SR34-514	S-CU-CHP	T-7F	ORSS-0757.5X1.0NBR70

Reference pages : Inserts → 2-58, CBN → 2-102, Shank, Accessory → 3-120

Screw-on toolholder with 95° approach angle, for WXGU inserts

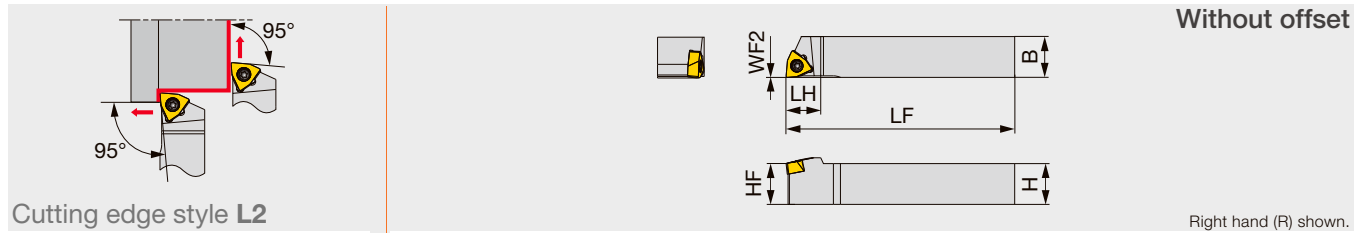

Designation	H	B	LF	LH	HF	WF2	RE**	Insert	Torque*
JSWL2XR/L1010X04	10	10	120	11	10	0	0.2	WXGU0403**L/R...	0.9
JSWL2XR/L1212F04	12	12	85	11	12	0	0.2	WXGU0403**L/R...	0.9
JSWL2XR/L1212X04	12	12	120	11	12	0	0.2	WXGU0403**L/R...	0.9
JSWL2XR/L1616X04	16	16	120	13	16	0	0.2	WXGU0403**L/R...	0.9
JSWL2XR/L2020H04	20	20	100	13	20	0	0.2	WXGU0403**L/R...	0.9

Torque*: Recommended clamping torque (N-m)

RE**: Standard corner radius

Use right-hand toolholders (R) with left-hand inserts (L); and left-hand toolholders (L) with right-hand inserts (R).

SPARE PARTS

Designation	Clamping screw	Wrench
QC12-JSWL2XR04 JSWL2XR/L...	SR34-514	T-7F

JPWL2XR/L

Lever-lock toolholder with 95° approach angle, for WXGU inserts

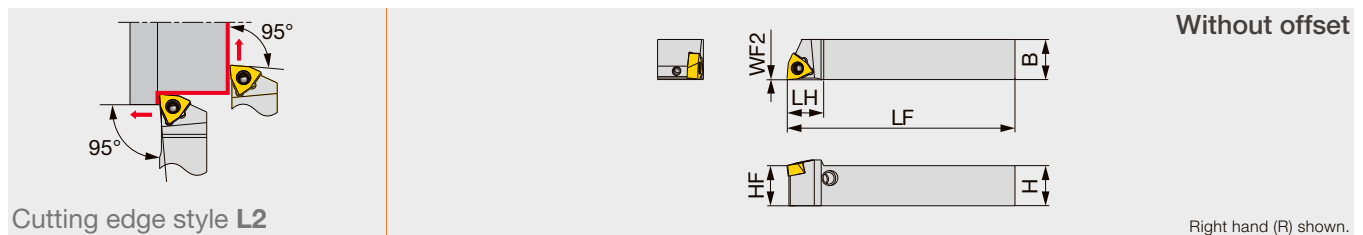

Designation	H	B	LF	LH	HF	WF2	RE**	Insert	Torque*
JPWL2XR/L1010X04	10	10	120	11	10	0	0.2	WXGU0403**L/R...	0.9
JPWL2XR/L1212F04	12	12	85	11	12	0	0.2	WXGU0403**L/R...	0.9
JPWL2XR/L1212X04	12	12	120	11	12	0	0.2	WXGU0403**L/R...	0.9
JPWL2XR/L1616X04	16	16	120	13	16	0	0.2	WXGU0403**L/R...	0.9

Torque*: Recommended clamping torque (N-m)

RE**: Standard corner radius

Use right-hand toolholders (R) with left-hand inserts (L); and left-hand toolholders (L) with right-hand inserts (R).

SPARE PARTS

Designation	Clamping screw 1	Lever	Pin	Clamping screw 2	Wrench 1	Wrench 2
JPWL2XR/L...	-	SLLV-2	SL-PI-2	SR10400611	-	HW2.0/5RED

DX

 **Rhombic, 55° with hole**

MINIFORCE QC12-JSDJ2XR-Y-CHP

Screw-on Y-axis turning modular head with 93° approach angle, for DX*U inserts, with high pressure coolant capability

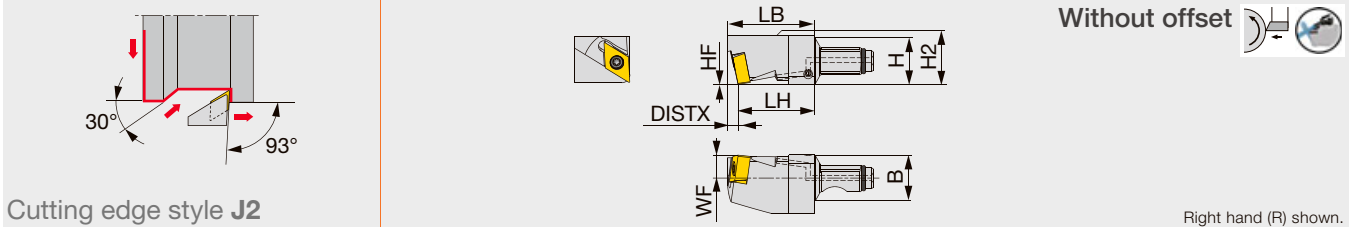

Designation	H	B	LH	HF	WF	LB	H2	DISTX	RE**	Insert	Torque*
QC12-JSDJ2XR07-Y-CHP	12	12	19.5	0	6	22.3	12.5	2.8	0.2	DX*U0703**L...	0.9
QC16-JSDJ2XR07-Y-CHP	16	16	21	0	8	23.8	16	2.8	0.2	DX*U0703**L...	0.9

Torque*: Recommended clamping torque (N·m)
RE**: Standard corner radius
Use right-hand toolholders (R) with left-hand inserts (L).

SPARE PARTS

Designation	Clamping screw	Wrench	O-ring
QC12-JSDJ2XR07-Y-CHP	SR34-514	T-7F	ORSS-0454.5X1.0NBR70

QC12-JSDJ2XR-CHP

Screw-on modular head with 93° approach angle, for DX*U inserts, with high pressure coolant capability

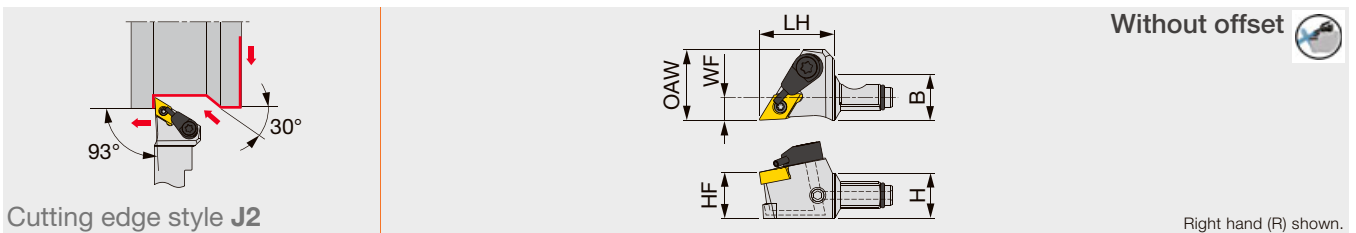

Designation	H	B	LH	HF	WF	OAW	RE**	Insert	Torque*
QC10-JSDJ2XR07-Y-CHP	10	10	17	10	5	13	0.2	DX*U0703**L...	0.9
QC12-JSDJ2XR07-Y-CHP	12	12	19.5	12	6	18.4	0.2	DX*U0703**L...	0.9
QC16-JSDJ2XR07-Y-CHP	16	16	21	16	8	20	0.2	DX*U0703**L...	0.9

Torque*: Recommended clamping torque (N·m)
RE**: Standard corner radius
Use right-hand toolholders (R) with left-hand inserts (L).

SPARE PARTS

Designation	Clamping screw	Wrench	Coolant unit	O-ring
QC10-JSDJ2XR07-Y-CHP	SR34-514	T-7F	-	ORSS-0757.5X1.0NBR70
QC12-JSDJ2XR07-Y-CHP	SR34-514	T-7F	S-CU-CHP	ORSS-0454.5X1.0NBR70
QC16-JSDJ2XR07-Y-CHP	SR34-514	T-7F	S-CU-CHP	ORSS-0757.5X1.0NBR70

Reference pages : Inserts → **2-32** -, Shank, Accessory → **3-120**

JSDJ2XR/L

Screw-on toolholder with 93° approach angle, for DX*U inserts

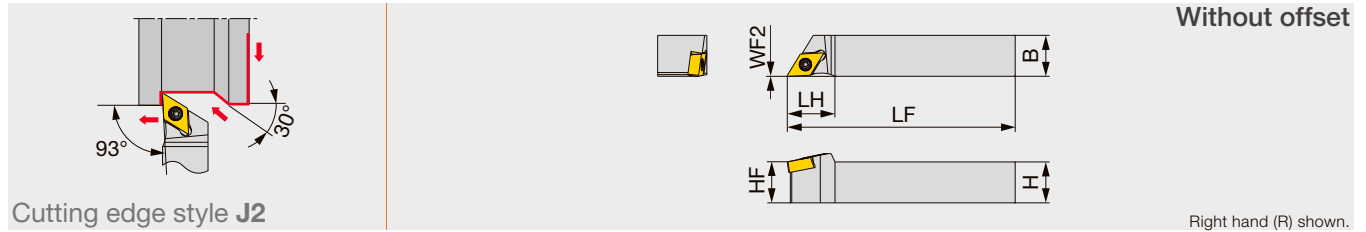

Cutting edge style J2

Designation	H	B	LF	LH	HF	WF2	RE**	Insert	Torque*
JSDJ2XR/L1010X07	10	10	120	14	10	0	0.2	DX*U0703**L/R...	0.9
JSDJ2XR/L1212F07	12	12	85	14	12	0	0.2	DX*U0703**L/R...	0.9
JSDJ2XR/L1212X07	12	12	120	14	12	0	0.2	DX*U0703**L/R...	0.9
JSDJ2XR/L1616X07	16	16	120	18	16	0	0.2	DX*U0703**L/R...	0.9
JSDJ2XR/L2020H07	20	20	100	18	20	0	0.2	DX*U0703**L/R...	0.9

Torque*: Recommended clamping torque (N-m) RE**: Standard corner radius
Use right-hand toolholders (R) with left-hand inserts (L); and left-hand toolholders (L) with right-hand inserts (R).

SPARE PARTS

Designation	Clamping screw	Coolant unit	Wrench	O-ring
QC12-JSDJ2XR07-CHP	SR34-514	S-CU-CHP	T-7F	ORSS-0454.5X1.0NBR70
JSDJ2XR/L...	SR34-514	-	T-7F	-

JPDJ2XR/L

Lever-lock toolholder with 93° approach angle, for DX*U inserts

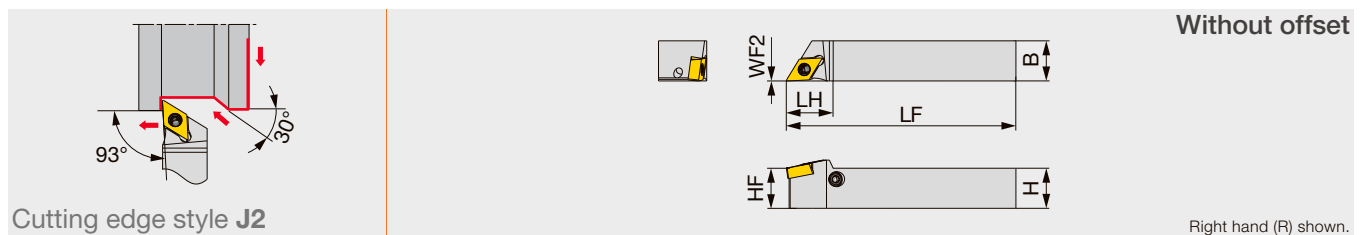

Cutting edge style J2

Designation	H	B	LF	LH	HF	WF2	RE**	Insert	Torque*
JPDJ2XR/L1010X07	10	10	120	14	10	0	0.2	DX*U0703**L/R...	0.9
JPDJ2XR/L1212F07	12	12	85	14	12	0	0.2	DX*U0703**L/R...	0.9
JPDJ2XR/L1212X07	12	12	120	14	12	0	0.2	DX*U0703**L/R...	0.9
JPDJ2XR/L1616X07	16	16	120	18	16	0	0.2	DX*U0703**L/R...	0.9

Torque*: Recommended clamping torque (N-m) RE**: Standard corner radius
Use right-hand toolholders (R) with left-hand inserts (L); and left-hand toolholders (L) with right-hand inserts (R).

SPARE PARTS

Designation	Lever	Pin	Clamping screw 1	Wrench 1	Clamping screw 2	Coolant unit	Wrench 2	Coolant plug	Wrench 3	DirectJet plug	Wrench 4
JPDJ2XR/L*07	SLLV-2	SL-PI-2	SR10400611	HW2.0/5RED	-	-	-	-	-	-	-
JSDJ2XR1012H07-CHP	-	-	-	-	SR34-514	-	T-7F	SR5/16UNFTL360	P-4	SSHM4-6-TB	P-2
JSDJ2XR*07-CHP	-	-	-	-	SR34-514	S-CU-CHP	T-7F	SR5/16UNFTL360	P-4	SSHM4-6-TB	P-2
JSDJ2XR/L1212F07-CHP	-	-	-	-	SR34-514	S-CU-CHP	T-7F	SR5/16UNFTL360	P-4	-	-
JSDJXR**F15	-	-	-	-	SR34-514	-	T-7F	-	-	-	-

Reference pages : Inserts → 2-32 -

Grade
Insert
Ext. Toolholder
Int. Toolholder
Threading
Grooving
Shaper
Endmill
Drilling Tool
Technical Reference

DX

 **Rhombic, 55° with hole**

MINIFORCE TURN JS-SDUXL

Screw-on round-shank toolholder with 93° approach angle, for DX*U inserts

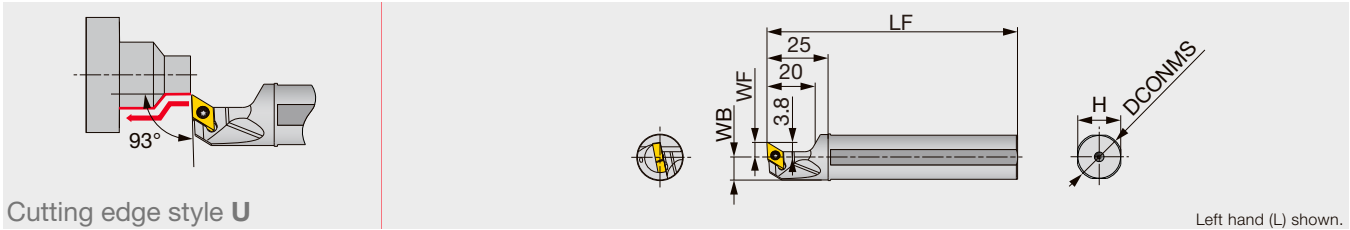

Cutting edge style U

Left hand (L) shown.

Designation	DCONMS	WF	LF	H	WB	RE**	Insert	Torque*
JS14H-SDUXL07	14	6	100	13	6.75	0.2	DX*U0703**L...	0.9
JS159F-SDUXL07	15.875	6	85	15	7.687	0.2	DX*U0703**L...	0.9
JS16F-SDUXL07	16	6	85	15	7.75	0.2	DX*U0703**L...	0.9
JS19G-SDUXL07	19.05	6	90	18	9.275	0.2	DX*U0703**L...	0.9
JS19X-SDUXL07	19.05	6	120	18	9.275	0.2	DX*U0703**L...	0.9
JS20G-SDUXL07	20	6	90	19	9.75	0.2	DX*U0703**L...	0.9
JS20X-SDUXL07	20	6	120	19	9.75	0.2	DX*U0703**L...	0.9
JS22X-SDUXL07	22	10	120	21	10.75	0.2	DX*U0703**L...	0.9
JS25H-SDUXL07	25	10	100	24	12.25	0.2	DX*U0703**L...	0.9
JS254X-SDUXL07	25.4	10	120	24	12.45	0.2	DX*U0703**L...	0.9

SPARE PARTS

Designation	Clamping screw	Wrench
JSDJXR/L..., JSDJXR**F15 JS**-SDUXL07	SR34-514	T-7F

QR12-SDUXL-CHP

Screw-on modular head with 93° approach angle, for DX*U inserts, with high pressure coolant capability

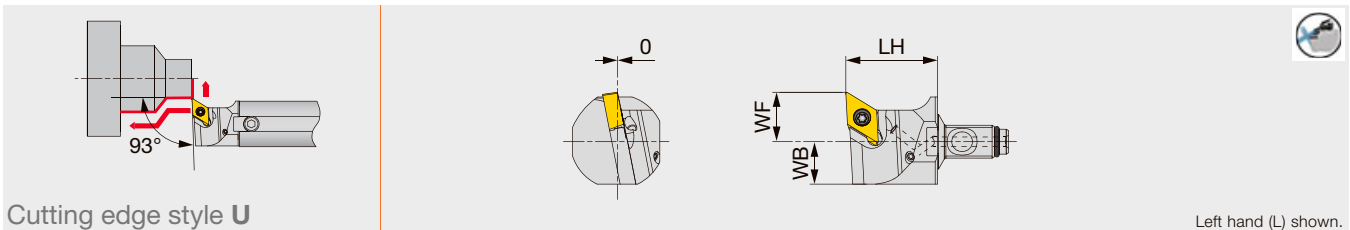

Cutting edge style U

Left hand (L) shown.

Designation	LH	WF	WB	RE**	Insert	Torque*	Shank
QR12C-SDUXL07-CHP	19.5	8.5	8	0.2	DX*U0703**L...	0.9	A16*-QR12
QR12D-SDUXL07-CHP	19.5	10.5	9	0.2	DX*U0703**L...	0.9	A19/20*-QR12

Use left-hand toolholders (L) with left-hand inserts (L).
Torque*: Recommended clamping torque (N·m)
RE**: Standard corner radius
Assembled dimensions with shank are shown on page 9.

SPARE PARTS

Designation	Clamping screw	Wrench	O-ring
QR12*-SDUXL07-CHP	SR 34-514	T-7F	ORSS-0454.5X1.0NBR70

Reference pages : Inserts → 2-32 -, Shank, Accessory → 3-120

QR12-SDLXL-CHP

Screw-on modular head with 95° approach angle, for DX*U inserts, with high pressure coolant capability

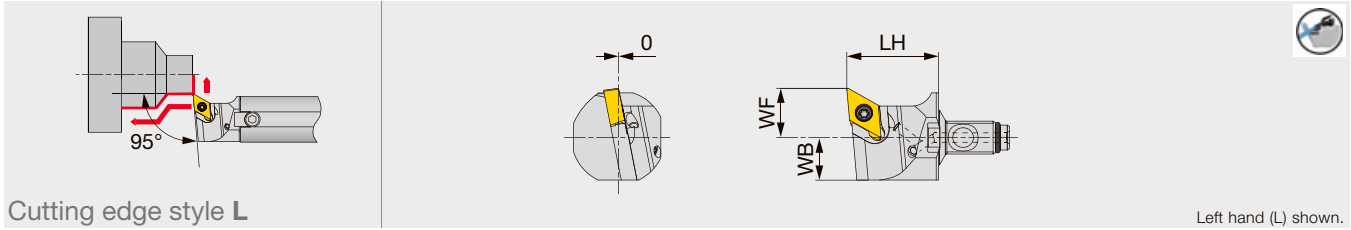

Designation	LH	WF	WB	RE**	Insert	Torque*	Shank
QR12C-SDLXL07-CHP	19.5	8.5	8	0.2	DX*U0703**L...	0.9	A16*-QR12
QR12D-SDLXL07-CHP	19.5	10.5	9	0.2	DX*U0703**L...	0.9	A19/20*-QR12

Use left-hand toolholders (L) with left-hand inserts (L).
 Torque*: Recommended clamping torque (N·m)
 RE**: Standard corner radius
 Assembled dimensions with shank are shown on page 9.

SPARE PARTS

Designation	Clamping screw	Wrench	O-ring
QR12*-SDLXL07-CHP	SR 34-514	T-7F	ORSS-0454.5X1.0NBR70

QR12-SDQXL-CHP

Screw-on modular head with 107.5° approach angle, for DX*U inserts, with high pressure coolant capability

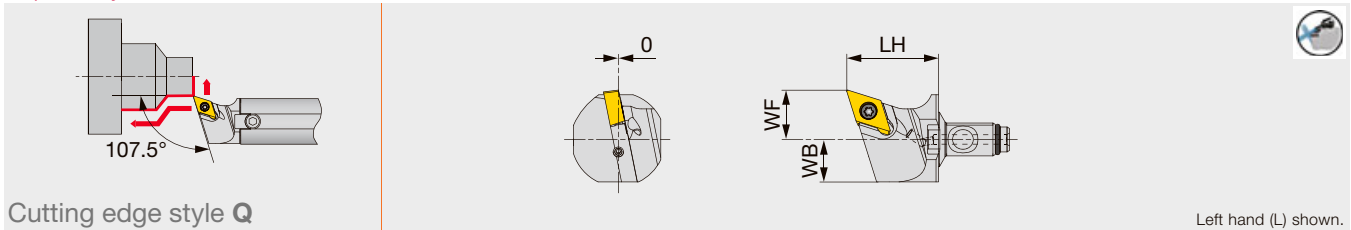

Designation	LH	WF	WB	RE**	Insert	Torque*	Shank
QR12C-SDQXL07-CHP	19.5	8.5	8	0.2	DX*U0703**L...	0.9	A16*-QR12
QR12D-SDQXL07-CHP	19.5	10.5	9	0.2	DX*U0703**L...	0.9	A19/20*-QR12

Use left-hand toolholders (L) with left-hand inserts (L).
 Torque*: Recommended clamping torque (N·m)
 RE**: Standard corner radius
 Assembled dimensions with shank are shown on page 9.

SPARE PARTS

Designation	Clamping screw	Wrench	O-ring
QR12*-SDQXL07-CHP	SR 34-514	T-7F	ORSS-0454.5X1.0NBR70

VX

 **Rhombic, 35° with hole**

MINIFORCE QC12-JSDNXR-CHP

Screw-on modular head with 62.5° approach angle, for DX*U inserts, with high pressure coolant capability

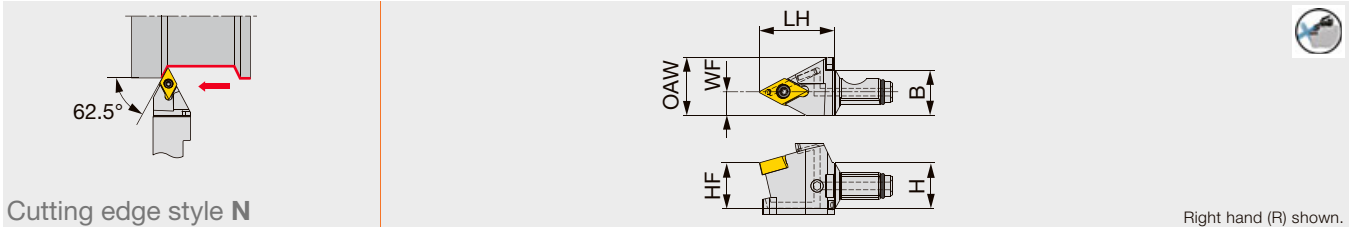

Designation	H	B	LH	HF	WF	OAW	RE**	Insert	Torque*
QC10-JSDNXR07-CHP	10	10	17	10	6	13	0.2	DX*U0703**L...	0.9
QC12-JSDNXR07-CHP	12	12	19.5	12	6	15	0.2	DX*U0703**L...	0.9
QC16-JSDNXR07-CHP	16	16	21	16	6	20	0.2	DX*U0703**L...	0.9

Torque*: Recommended clamping torque (N-m)
RE**: Standard corner radius
Use right-hand toolholders (R) with left-hand inserts (L).

SPARE PARTS

Designation	Clamping screw	Wrench	O-ring
QC10-JSDNXR07-CHP	SR34-514	T-7F	ORSS-0353.5X1.0NBR70
QC12-JSDNXR07-CHP	SR34-508	T-7F	ORSS-0454.5X1.0NBR70
QC16-JSDNXR07-CHP	SR34-514	T-7F	ORSS-0757.5X1.0NBR70

QC12-JSVJ2XR-CHP

Screw-on modular head with 93° approach angle, for VXGU inserts, with high pressure coolant capability

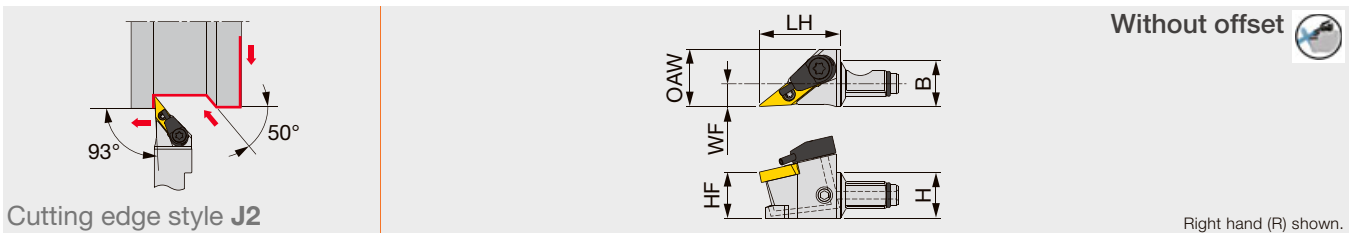

Designation	H	B	LH	HF	WF	OAW	RE**	Insert	Torque*
QC10-JSVJ2XR09-CHP	10	10						VXGU09T2**L...	0.9
QC12-JSVJ2XR09-CHP	12	12	21	12	6	15	0.2	VXGU09T2**L...	0.9
QC16-JSVJ2XR09-CHP	16	16						VXGU09T2**L...	0.9

Torque*: Recommended clamping torque (N-m)
RE**: Standard corner radius
Use right-hand toolholders (R) with left-hand inserts (L).

SPARE PARTS

Designation	Clamping screw	Coolant unit	Wrench	O-ring
QC10-JSVJ2XR09-CHP	SR 34-508	-	T-7F	ORSS-0353.5X1.0NBR70
QC12-JSVJ2XR09-CHP	SR34-508	S-CU-CHP	T-7F	ORSS-0454.5X1.0NBR70
QC16-JSVJ2XR09-CHP	SR34-508	S-CU-CHP	T-7F	ORSS-0757.5X1.0NBR70

Reference pages : QC12-JSDNXR-CHP : Inserts → **2-32** -
QC12-JSVJ2XR-CHP : Inserts → **2-53**
Shank, Accessory → **3-120**

JSVJ2XR/L

Screw-on toolholder with 93° approach angle, for VXGU inserts

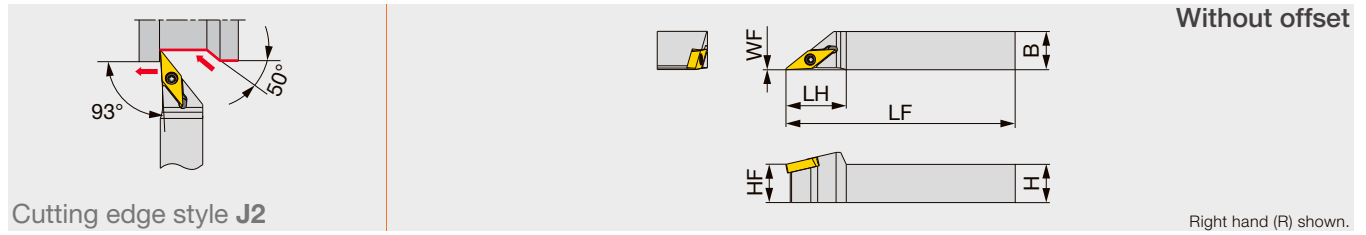

Designation	H	B	LF	LH	HF	WF	RE**	Insert	Torque*
JSVJ2XR/L1010X09	10	10	120	17	10	0	0.2	VXGU09T2**/L...	0.9
JSVJ2XR/L1212F09	12	12	85	19	12	0	0.2	VXGU09T2**/L...	0.9
JSVJ2XR/L1212X09	12	12	120	19	12	0	0.2	VXGU09T2**/L...	0.9
JSVJ2XR/L1616X09	16	16	120	19	16	0	0.2	VXGU09T2**/L...	0.9
JSVJ2XR/L2020H09	20	20	100	19	20	0	0.2	VXGU09T2**/L...	0.9

Torque*: Recommended clamping torque (N-m) RE**: Standard corner radius
 Use right-hand toolholders (R) with left-hand inserts (L).
 Use left-hand toolholders (L) with right-hand inserts (R).

Designation	Clamping screw	Wrench	Lever	Pin	Clamping screw	Wrench
JSVJ2XR/L...	SR34-508	T-7F	-	-	-	-
JPVJ2XR/L...	-	-	SLLV-1	SL-PI-2	SR10400611	HW2.0/5RED

MINIFORCE JPVJ2XR/L

Lever-lock toolholder with 93° approach angle, for VXGU inserts

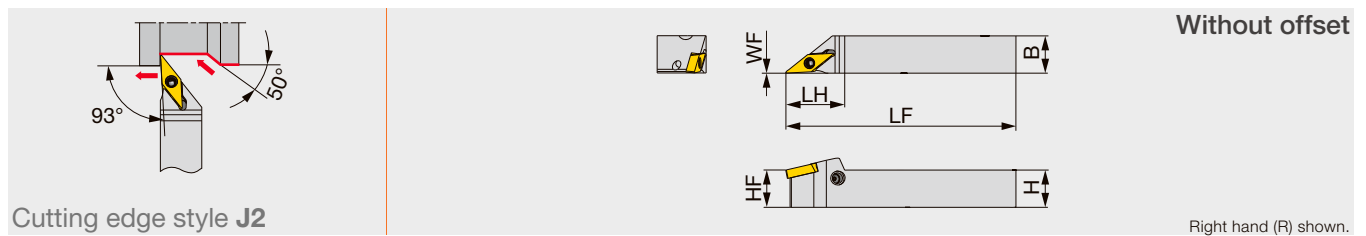

Designation	H	B	LF	LH	HF	WF	RE**	Insert	Torque*
JPVJ2XR/L1010X09	10	10	120	19	10	0	0.2	VXGU09T2**/L...	0.9
JPVJ2XR/L1212F09	12	12	85	19	12	0	0.2	VXGU09T2**/L...	0.9
JPVJ2XR/L1212X09	12	12	120	19	12	0	0.2	VXGU09T2**/L...	0.9
JPVJ2XR/L1616X09	16	16	120	19	16	0	0.2	VXGU09T2**/L...	0.9

Torque*: Recommended clamping torque (N-m) RE**: Standard corner radius
 Use right-hand toolholders (R) with left-hand inserts (L).
 Use left-hand toolholders (L) with right-hand inserts (R).

Designation	Clamping screw	Wrench	Lever	Pin	Clamping screw	Wrench
JSVJ2XR/L...	SR34-508	T-7F	-	-	-	-
JPVJ2XR/L...	-	-	SLLV-1	SL-PI-2	SR10400611	HW2.0/5RED

VX

 **Rhombic, 35° with hole**

JS-SVUXL

Screw-on round-shank toolholder with 93° approach angle, for VXGU inserts

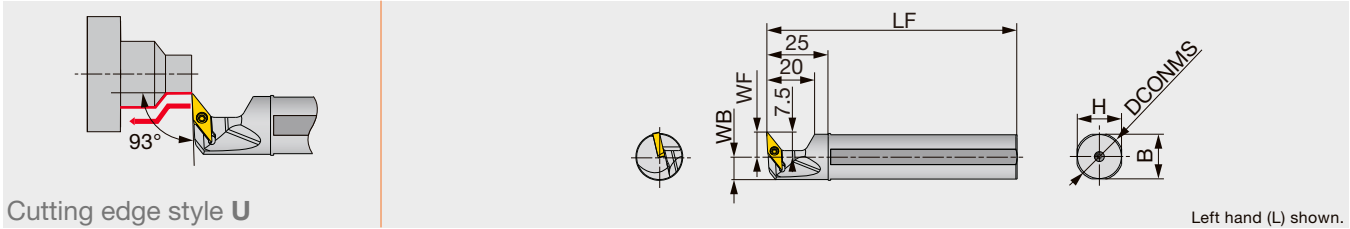

Designation	DCONMS	WF	LF	H	B	WB	RE**	Insert	Torque*
JS159F-SVUXL09	15.875	10	85	15	15	7.7	0.2	VXGU09T2**L...	0.9
JS16F-SVUXL09	16	10	85	15	15	7.7	0.2	VXGU09T2**L...	0.9
JS19G-SVUXL09	19.05	10	90	18	18	9.2	0.2	VXGU09T2**L...	0.9
JS19X-SVUXL09	19.05	10	120	18	18	9.2	0.2	VXGU09T2**L...	0.9
JS20G-SVUXL09	20	10	90	19	19	9.7	0.2	VXGU09T2**L...	0.9
JS20X-SVUXL09	20	10	120	19	19	9.7	0.2	VXGU09T2**L...	0.9
JS22X-SVUXL09	22	10	120	21	21	10.7	0.2	VXGU09T2**L...	0.9
JS25H-SVUXL09	25	10	100	24	24	12.2	0.2	VXGU09T2**L...	0.9
JS254X-SVUXL09	25.4	10	120	24	24	12.4	0.2	VXGU09T2**L...	0.9

*Torque: Recommended clamping torque (N·m) **RE: Standard corner radius
Note: Use left-hand toolholders (L) with left-hand inserts (L).

SPARE PARTS

Designation	Clamping screw	Wrench
JSVJXR/L..., JS**-SVUXL09	SR34-508	T-7F

MODUM^{INI}TURN

QR12-SVUXL-CHP

Screw-on modular head with 93° approach angle, for VXGU inserts, with high pressure coolant capability

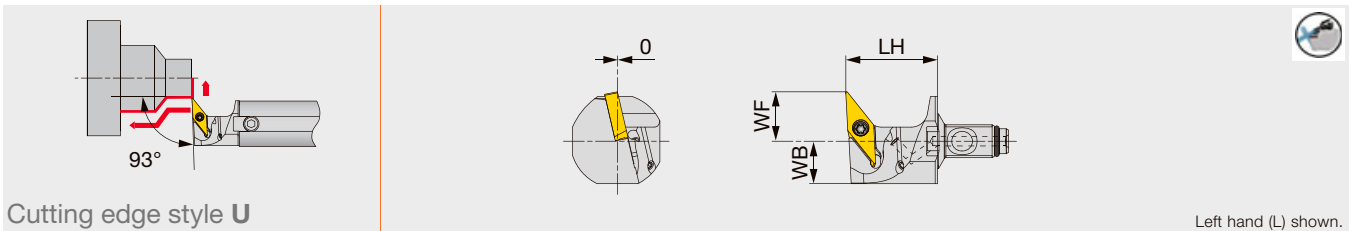

Designation	LH	WF	WB	RE**	Insert	Torque*	Shank
QR12C-SVUXL09-CHP	19.5	8.5	9.5	0.2	VXGU09T2**L...	0.9	A16*-QR12
QR12D-SVUXL09-CHP	19.5	10.5	9	0.2	VXGU09T2**L...	0.9	A19/20*-QR12

Use left-hand toolholders (L) with left-hand inserts (L).
Torque*: Recommended clamping torque (N·m)
RE**: Standard corner radius
Assembled dimensions with shank are shown on page 9.

Reference pages : Inserts → 2-53, Shank, Accessory → 3-120

QR12-SVQXL-CHP

Screw-on modular head with 117.5° approach angle, for VXGU inserts, with high pressure coolant capability

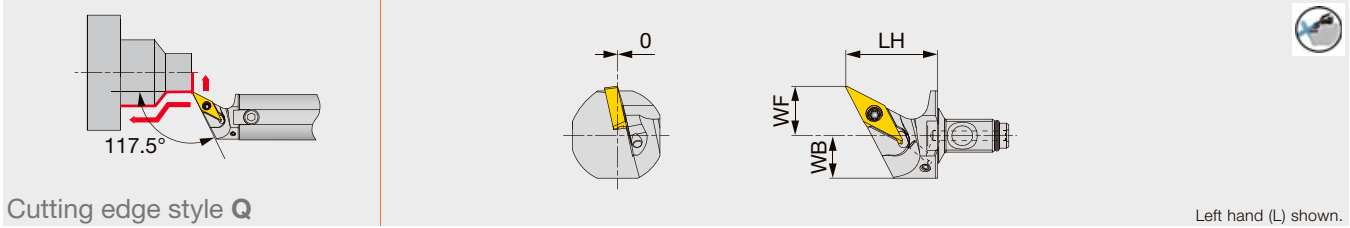

Designation	LH	WF	WB	RE**	Insert	Torque*	Shank
QR12C-SVQXL09-CHP	19.5	8.5	8	0.2	VXGU09T2**L...	0.9	A16*-QR12
QR12D-SVQXL09-CHP	19.5	10.5	9	0.2	VXGU09T2**L...	0.9	A19/20*-QR12

Use left-hand toolholders (L) with left-hand inserts (L).
 Torque*: Recommended clamping torque (N·m)
 RE**: Standard corner radius
 Assembled dimensions with shank are shown on page 9.

SPARE PARTS

Designation	Clamping screw	Wrench	O-ring
QR12*-SVUXL09-CHP	SR 34-508	T-7F	ORSS-0454.5X1.0NBR70
QR12*-SVQXL09-CHP			

MINIFORCE QC12-JSVVXR-CHP

Screw-on modular head with 72.5° approach angle, for VXGU inserts, with high pressure coolant capability

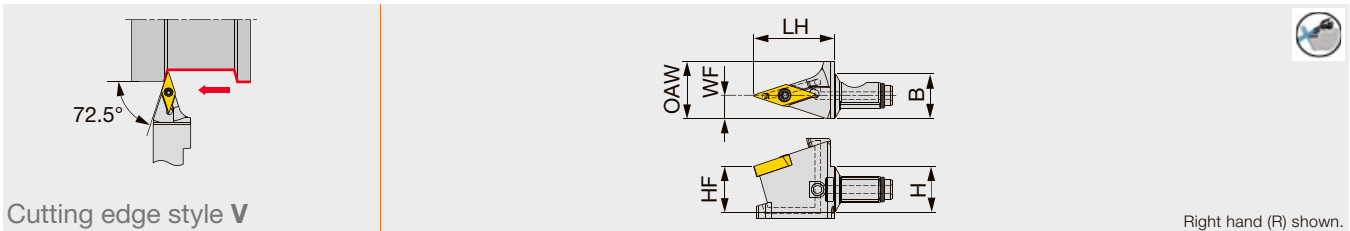

Designation	H	B	LH	HF	WF	OAW	RE**	Insert	Torque*
QC10-JSVVXR09-CHP	10	10	17.5	10	5	13	0.2	VXGU09T2**L...	0.9
QC12-JSVVXR09-CHP	12	12	21	12	6	15	0.2	VXGU09T2**L...	0.9
QC12-JSVVXR09-CHP	16	16	21	16	6	20	0.2	VXGU09T2**L...	0.9

Torque*: Recommended clamping torque (N·m)
 RE**: Standard corner radius
 Use right-hand toolholders (R) with left-hand inserts (L).

SPARE PARTS

Designation	Clamping screw	Wrench	O-ring
QC10-JSVVXR09-CHP	SR34-508	T-7F	ORSS-0353.5X1.0NBR70
QC12-JSVVXR09-CHP	SR34-508	T-7F	ORSS-0454.5X1.0NBR70
QC16-JSVVXR09-CHP	SR34-508	T-7F	ORSS-0757.5X1.0NBR70

TN



Triangular with hole

QC16-PTL2NR-Y-CHP

Lever-lock Y-axis turning modular head with 95° approach angle, for negative 60° triangular inserts, with high pressure coolant capability

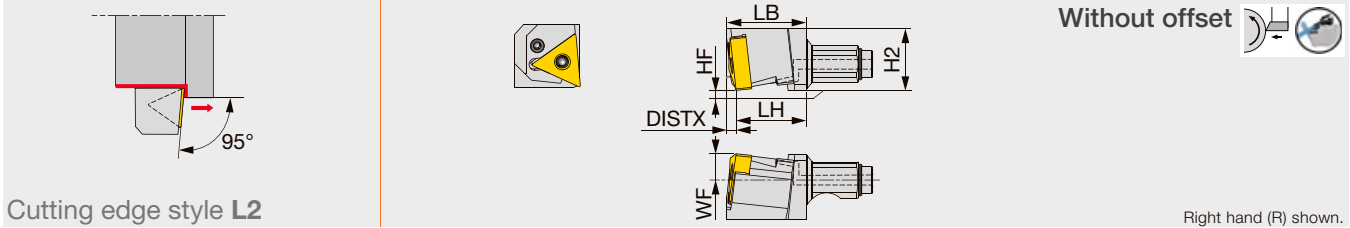

Designation	LH	HF	WF	LB	H2	DISTX	RE**	Insert	Torque*	Shank
QC16-PTL2NR16-Y-CHP	21	0	8	23.8	18.7	2.8	0.4	TN**1604...	1.5	QC-16...

Torque*: Recommended clamping torque (N-m)
RE**: Standard corner radius

QC16-PTL2NR-CHP

Lever-lock modular head with 95° approach angle, for negative 60° triangular inserts, with high pressure coolant capability

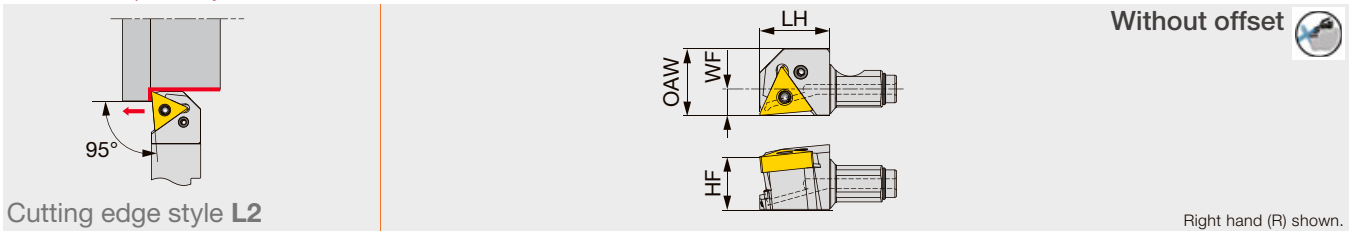

Designation	LH	HF	WF	OAW	RE**	Insert	Torque*	Shank
QC16-PTL2NR16-CHP	21	16	8	20	0.4	TN**1604...	1.5	QC-16...

Torque*: Recommended clamping torque (N-m)
RE**: Standard corner radius

SPARE PARTS

Designation	Clamping screw	Wrench	Lever	O-ring
QC16-PTL2NR16-Y-CHP	LCS33	P-2	LCL33N	ORSS-0757.5X1.0NBR70
QC16-PTL2NR16-CHP	LCS33	P-2	LCL33N	-

JTTLNR/L

Back-clamp toolholder with 95° approach angle, for negative 60° triangular inserts

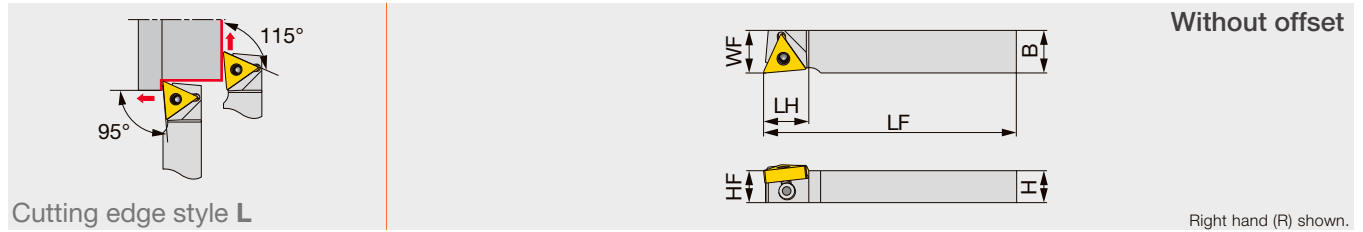

Designation	H	B	LF	LH	HF	WF	RE**	Insert	Torque*
JTTLNR/L1216F16	12	16	85	17	12	16	0.4	TN**1604...	1
JTTLNR/L1216X16	12	16	120	17	12	16	0.4	TN**1604...	1
JTTLNR/L1616X16	16	16	120	17	16	16	0.4	TN**1604...	1

Torque*: Recommended clamping torque (N-m)

RE**: Standard corner radius

SPARE PARTS

Designation	Clamp	Shim	Clamping screw	Clamping screw 1	Wrench	Wrench 1	Spring pin	Lever
PTL2NR/L...	-	LST317 D30	-	LCS3	-	P-2.5	LSP3	LCL3
JTTLNR/L...	JCP-3N	-	JDS-5040	-	P-2.5F	-	-	-

PTGNR/L

Lever-lock toolholder with 91° approach angle, for negative triangular inserts

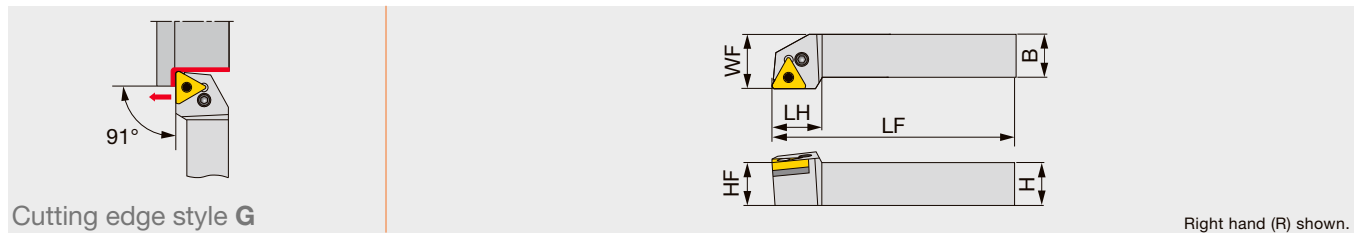

Designation	H	B	LF	LH	HF	WF	RE**	Insert	Torque*
PTGNR/L1616	16	16	100	22	16	20	0.8	TN**1604...	2
PTGNR/L2020K1104	20	20	125	20	20	25	0.8	TN**1104...	2
PTGNR/L2020	20	20	125	22	20	25	0.8	TN**1604...	2

*Torque: Recommended clamping torque (N-m) **RE: Standard corner radius

SPARE PARTS

Designation	Shim	Clamping screw	Wrench	Spring pin	Lever
PTGNR/L1616, 2020	LST317	LCS3	P-2.5	LSP3	LCL3
PTGNR/L2020K1104	-	LCS23A	P-2.5	-	LCL23

TN



TUNG T^{URN} JET PTGNR/L-CHP

Tube connection

Lever lock toolholders – 91° approach angle.
For negative triangle insert. High-pressure coolant capability.

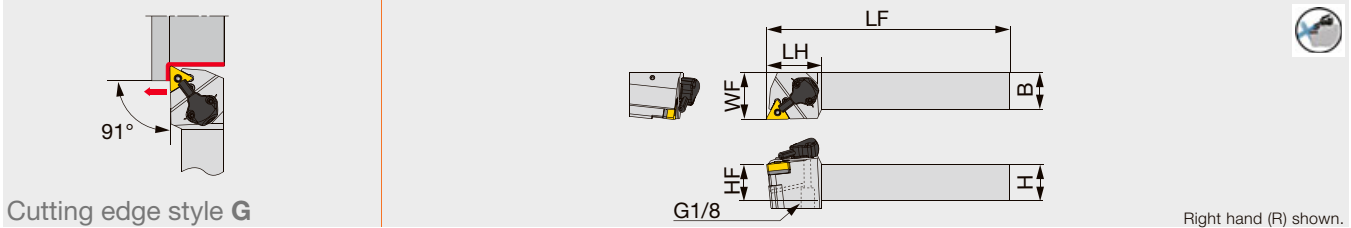

Designation	H	B	LF	LH	HF	WF	RE**	Insert	Torque*
PTGNR/L2020K1104-CHP	20	20	125	38	20	32	0.8	TN**1104...	2
PTGNR/L2020K16-CHP	20	20	125	38	20	32	0.8	TN**1604...	2

*Torque: Recommended torque (N-m) for clamping
**RE: Standard corner radius

SPARE PARTS

Designation	Shim	Clamping screw	Wrench 1	Spring pin	Lever
PTGNR/L2020K1104-CHP	-	LCS23A	P-2.5	LSP3	LCL23
PTGNR/L2020K16-CHP	LST317	LCS3	P-2.5	LSP3	LCL3

SPARE PARTS

Designation	Coolant unit	Mounting screw	Wrench 2	O-ring	Coolant screw	Wrench 3
PTGNR/L2020K1104-CHP	CU-CW-CHP	SRM3	T-8F	OR6.4X0.9N	SRM4X4TL360	P-2
PTGNR/L2020K16-CHP	CU-CW-CHP	SRM3	T-8F	OR6.4X0.9N	SRM4X4TL360	P-2

TURNING^A PTFNR/L

Lever-lock toolholder with 91° approach angle, for negative triangular inserts

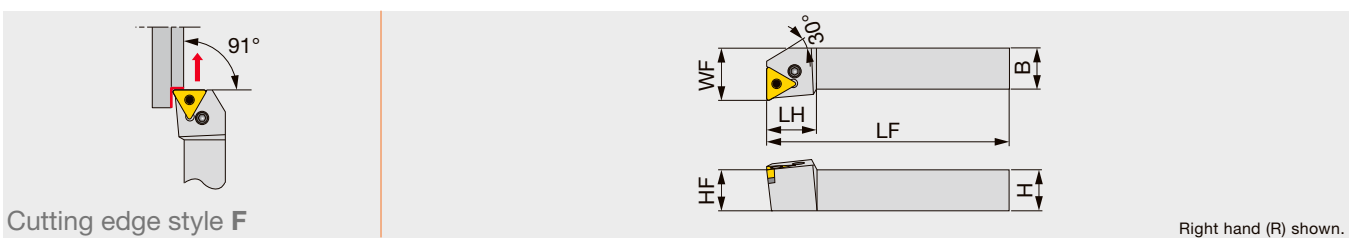

Designation	H	B	LF	LH	HF	WF	RE**	Insert	Torque*
PTFNR/L1616	16	16	100	22	16	20	0.8	TN**1604...	2
PTFNR/L2020K1104	20	20	125	16	20	25	0.8	TN**1104...	2
PTFNR/L2020	20	20	125	22	20	25	0.8	TN**1604...	2

*Torque: Recommended clamping torque (N-m)
**RE : Standard corner radius

SPARE PARTS

Designation	Shim	Clamping screw 1	Clamping screw 2	Wrench	Spring pin	Lever
PTFNR/L1616, 2020	LST317	-	LCS3	P-2.5	LSP3	LCL3
PTFNR/L**1104	-	LCS23A	-	P-2.5	-	LCL23

Reference pages : Inserts → 2-75 -, CBN → 2-113 -, PCD → 2-129

PTXN-OH3

Lever-lock toolholder with 100° approach angle, for negative 60° rhombic inserts, with high pressure coolant capability

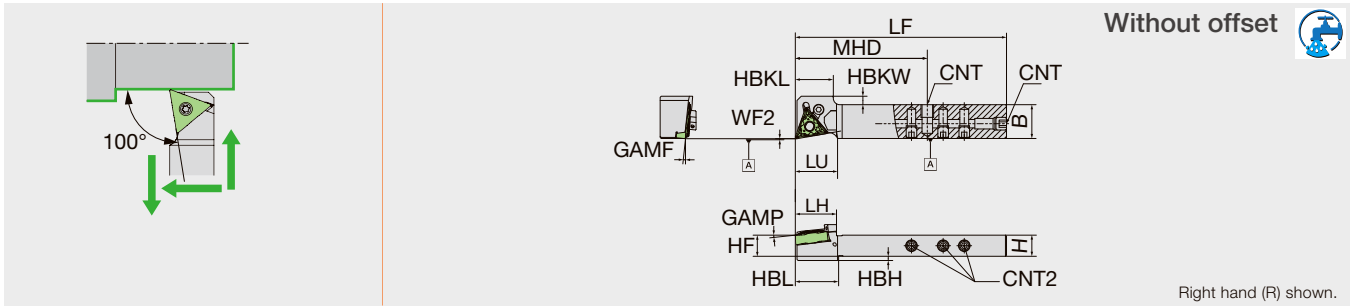

Designation	H	B	LF	LH	GAMF	GAMP	GAMP	HBKL	HBKW	HBL	HF	LU	MHD	WF2	CNT	CNT2	Insert
PTXNR1016X33N-OH3	10	16	100	19.5	6°	6°	2	18	4	20.5	10	20	62.5	0	M6*1	M5	TN..1604..
PTXNR1616X33N-OH3	16	16	120	19.5	6°	6°	-	18	4	-	16	20	78.75	0	Rc1/8	M5	TN..1604..

NOTE: Reference Chart of OH3 Hole Position → 10-1

SPARE PARTS

Designation	Clamp screw	Lever	Screw (for CNT)	Screw (for CNT2)	Wrench (for Clamp screw)
PTXNR**X33N-OH3	LCS33	LCL33N	SS0605SC	SS0505SC	LW-2.5

PTXN-OH2

Lever-lock toolholder with 100° approach angle, for negative 60° rhombic inserts, with high pressure coolant capability

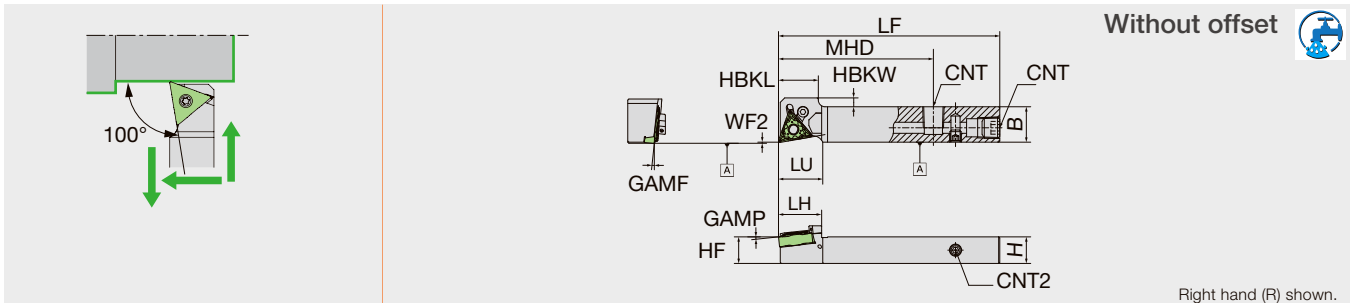

Designation	H	B	LF	LH	GAMF	GAMP	HBKL	HBKW	HF	LU	MHD	WF2	CNT	CNT2	Insert
PTXNR1216X33N-OH2	12	16	100	19.5	6°	6°	18	4	12	20	70	0	Rc1/8	M5	TN..1604..

SPARE PARTS

Designation	Clamp screw	Lever	Screw (for CNT)	Screw (for CNT2)	Wrench (for Clamp screw)
PTXNR1216X33N-OH2	LCS33	LCL33N	SPR1/8	SS0505SC	LW-2.5

Reference pages : Inserts → 2-75 -, CBN → 2-113 -, PCD → 2-129

Grade
Insert
Ext. Toolholder
Int. Toolholder
Threading
Grooving
Shaper
Endmill
Drilling Tool
Technical Reference

TN



PTXN-N

Lever-lock toolholder with 100° approach angle, for negative 60° rhombic inserts

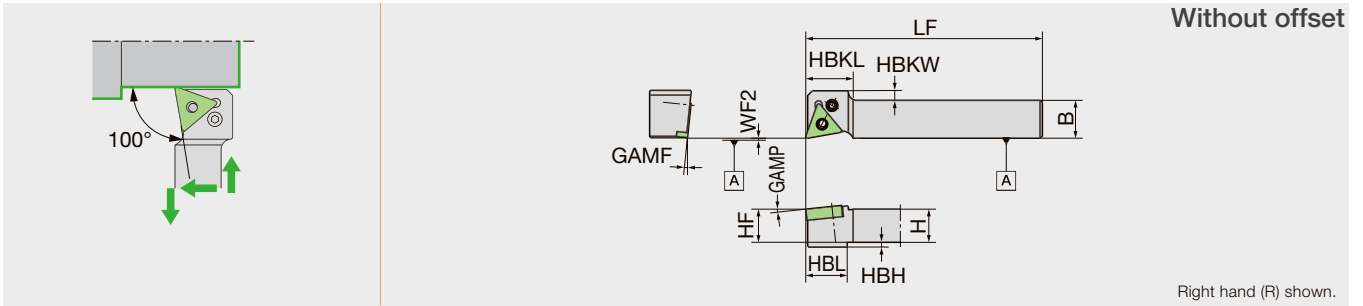

Designation	H	B	LF	GAMF	GAMP	HBH	HBKL	HBKW	HBL	HF	WF2	Insert
PTXNR1016X33N	10	16	120	6°	6°	2	18	4	17.5	10	0	TN..1604..
PTXNR1216X33N	12	16	120	6°	6°	-	18	4	-	12	0	TN..1604..
PTXNR1216X33NGX	12	16	85	6°	6°	-	18	4	-	12	0	TN..1604..
PTXNR1616X33N	16	16	120	6°	6°	-	18	4	-	16	0	TN..1604..
PTXNR2020X33N	20	20	120	6°	6°	-	18	-	-	20	0	TN..1604..

SPARE PARTS



Designation	Clamp screw	Lever	Wrench (for Clamp screw)
PTXNR**	LCS33	LCL33N	LW-2

DS-PTX-ACH

Lever-lock round-shank toolholder with 100° approach angle, for negative 60° rhombic inserts, with adjustable centerline height capability

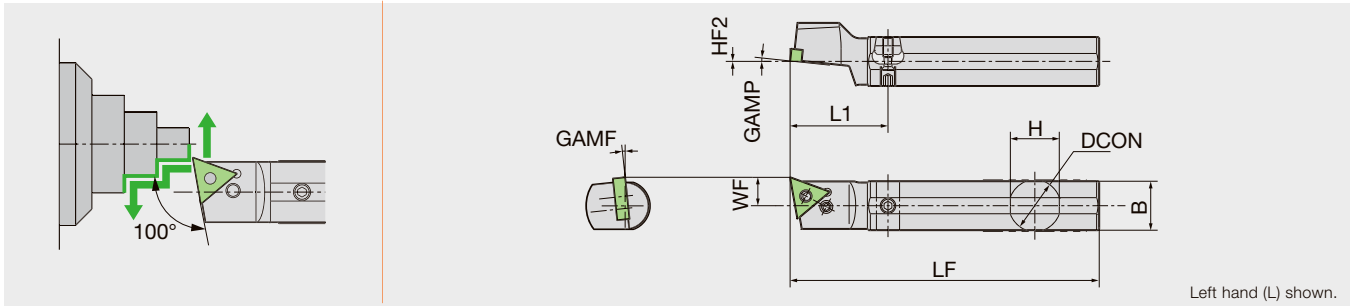

Designation	H	B	LF	DCON	GAMF	GAMP	HF2	L1	WF	Insert
DS-PTXL16-33-ACH	15.5	15	120	16	6°	6°	Type B(0~+0.3)	38	11	TN..1604..
DS-PTXL19-33-ACH	18	18	120	19.05	6°	6°	Type B(0~+0.3)	38	11	TN..1604..
DS-PTXL20-33-ACH	19	19	120	20	6°	6°	Type B(0~+0.3)	38	11	TN..1604..
DS-PTXL22-33-ACH	21	21	120	22	6°	6°	Type B(0~+0.3)	38	12	TN..1604..
DS-PTXL25-33-ACH	24	24	150	25.4	6°	6°	Type A(0~+0.2)	38	13	TN..1604..
DS-PTXL25-33MET-ACH	24	24	150	25	6°	6°	Type A(0~+0.2)	38	13	TN..1604..

NOTE: Use a right-handed (R) or non-handed insert.

SPARE PARTS



Designation	Clamp screw	Screw (for Wedge)	Lever	Wedge	Wrench (for Wedge)
DS-PTXL16-33-ACH	LCS33	WS060415-003	LCL33N	ACH-W18	LW-2
DS-PTXL19-33-ACH	LCS33	WS060415-003	LCL33N	ACH-W18	LW-2
DS-PTXL20-33-ACH	LCS33	WS060419-004	LCL33N	ACH-W18	LW-2
DS-PTXL22-33-ACH	LCS33	WS060419-004	LCL33N	ACH-W18	LW-2
DS-PTXL25-33**	LCS33	WS060419-004	LCL33N	ACH-W24	LW-2

DS-PTX

Lever-lock round-shank toolholder with 100° approach angle, for negative 60° rhombic inserts

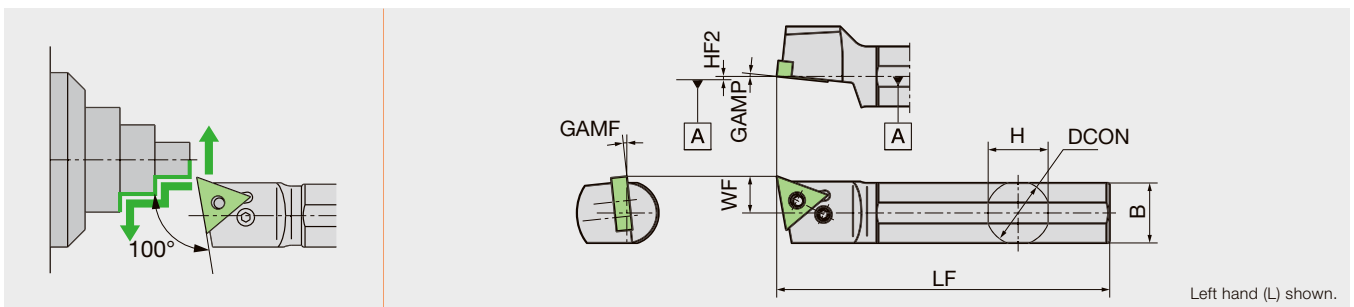

Designation	H	B	LF	DCON	GAMF	GAMP	HF2	L1	WF	Insert
DS-PTXL16-33	15	15	120	16	6°	6°	0	-	11	TN..1604..
DS-PTXL19-33	18	18	120	19.05	6°	6°	0	-	11	TN..1604..
DS-PTXL20-33	19	19	120	20	6°	6°	0	-	11	TN..1604..
DS-PTXL22-33	21	21	120	22	6°	6°	0	-	12	TN..1604..
DS-PTXL25M-33	24	24	150	25.4	6°	6°	0	-	13	TN..1604..

NOTE: Use a right-handed (R) or non-handed insert.

SPARE PARTS



Designation	Clamp screw	Lever	Wrench (for Clamp screw)
DS-PTXL**	LCS33	LCL33N	LW-2

Reference pages : Inserts → 2-75 -, CBN → 2-113 -, PCD → 2-129

Grade
Insert
Ext. Toolholder
Int. Toolholder
Threading
Grooving
Shaper
Endmill
Drilling Tool
Technical Reference

TN



Triangular with hole

C-PTUNL-CHP

Lever-lock toolholder, with 93° approach angle, for negative 60° triangular inserts, with high pressure coolant capability

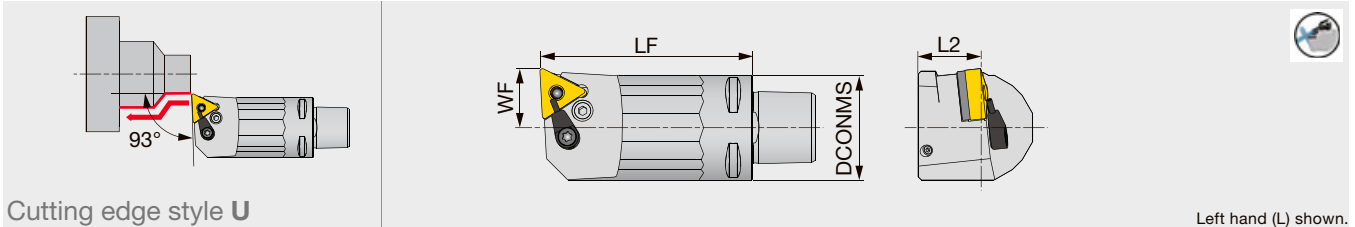

Left hand (L) shown.

Designation	DCONMS	LF	L2	WF	RE	Insert
C3PTUNL18040-16-CHP	32	40	19	18	0.8	TN**1604...
C3PTUNL18065-16-CHP	32	65	19	18	0.8	TN**1604...

Applicable for 14 MPa coolant
Cannot be used for boring

SPARE PARTS

Designation	Coolant unit	Shim	Lever	Clamping screw	Spring pin	Wrench
C3PTUNL...	S-CU-CHP	LST317	LCL3	LCS3	LSP3	P-2.5

TURNING

ATQNR/L

Double-clamp toolholder with 105° approach angle, for negative 60° triangular inserts

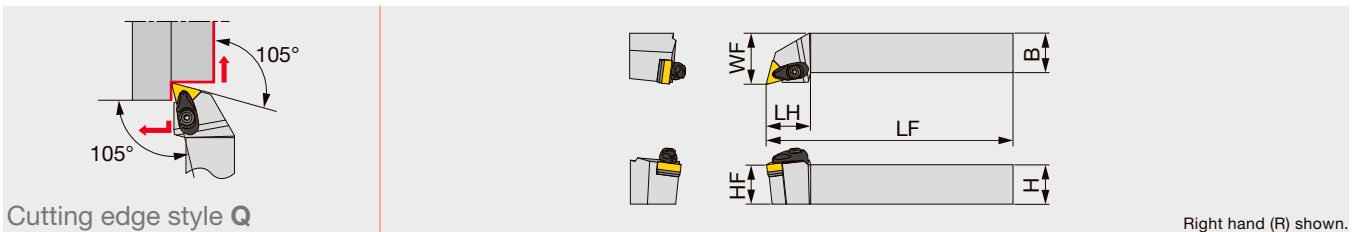

Right hand (R) shown.

Designation	H	B	LF	LH	HF	WF	RE**	Insert	Torque*
ATQNR/L2020K16-A	20	20	125	28	20	25	0.8	TN**1604...	3

*Torque: Recommended clamping torque (N·m)

**RE : Standard corner radius

SPARE PARTS

Designation	Clamp	Clamp screw	Spring	Spring pin	Shim	Shim screw	Wrench
ATQNR/L**16-A	ACP3S	ACS-5W	BP-7	SP-2.5	AST322	CSTB-3.5	T-15F



Rhombic, 80° with hole

PCL2NR

Lever-lock toolholder with 95° approach angle, for negative 80° rhombic inserts

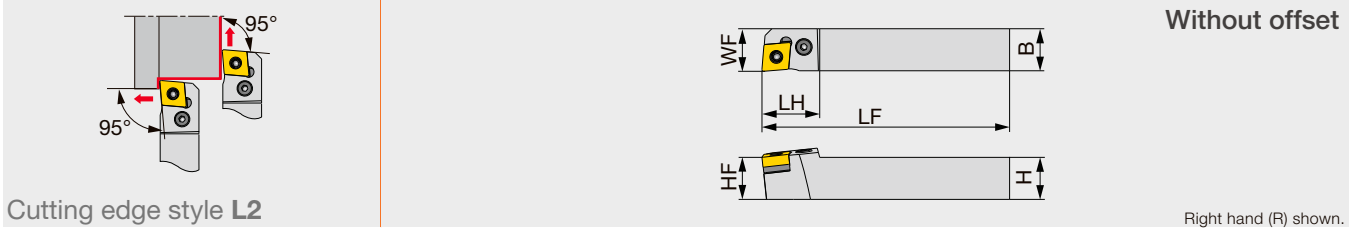

Designation	H	B	LF	LH	HF	WF	RE**	Insert	Torque*
PCL2NR2020H12	20	20	100	26	20	20	0.8	CN/GN**1204...	3

Torque*: Recommended clamping torque (N·m)
RE**: Standard corner radius

SPARE PARTS

Designation	Shim	Clamping screw	Lever	Spring pin	Wrench
PCL2NR2020H12	LSC42	LCS4	LCL4	LSP4	P-3

PCLN-N

Lever-lock toolholder with 95° approach angle, for negative 80° rhombic inserts

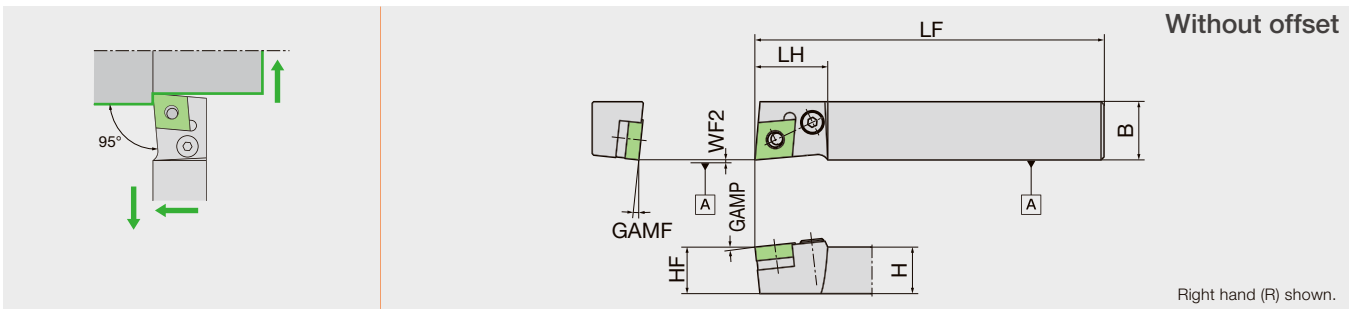

Designation	H	B	LF	LH	GAMP	GAMP	HF	WF2	Insert
PCLNR1620X43N	16	20	120	25	6°	6°	16	0	CN..1204..

SPARE PARTS

Designation	Shim seat	Clamp screw	Lever	Spring	Wrench (for Clamp screw)
PCLNR1620X43N	LSC42	LCS4CA	LCL4	LSP4	LW-3

CN



Rhombic, 80° with hole

PCLNR/L

Lever-lock toolholder with 95° approach angle, for negative 80°/70° rhombic inserts

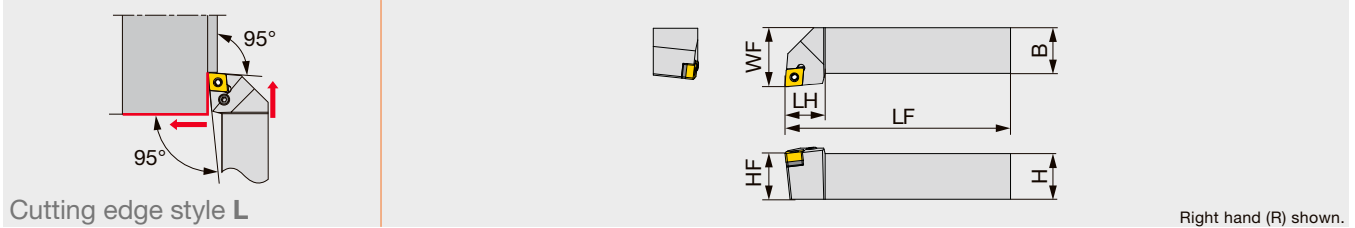

Designation	H	B	LF	LH	HF	WF	RE**	Insert	Torque*
PCLNR/L1616H09	16	16	100	20	16	20	0.8	CN**0903...	2
PCLNR/L1616	16	16	100	26	16	20	0.8	CN**/GNGA1204...	3
PCLNR/L1616H12E	16	16	100	26	16	20	0.8	CN**/GNGA1204...	3
PCLNR/L2020K09	20	20	125	20	20	25	0.8	CN**0903...	2
PCLNR/L2020K0904	20	20	125	20	20	25	0.8	CN**/GNMG0904...	2
PCLNR/L2020	20	20	125	28	20	25	0.8	CN**/GNGA1204...	3
PCLNR/L2020K12E	20	20	125	28	20	25	0.8	CN**/GNGA1204...	3

*Torque: Recommended clamping torque (N·m)

**RE: Standard corner radius

SPARE PARTS

Designation	Shim	Clamping screw	Wrench	Spring pin	Lever
PCLNR/L**09	ELSC32	LCS3	P-2.5	LSP3L	LCL33
PCLNR/L1616	LSC42	LCS4CA	P-3	LSP4	LCL4
PCLNR/L1616H12E	ELSC42	LCS4CA	P-3	LSP4S	LCL43S
PCLNR/L**0904	LSC317	LCS3	P-2.5	LSP3	LCL33
PCLNR/L2020	LSC42	LCS4	P-3	LSP4	LCL4
PCLNR/L2020K12E	ELSC42	LCS4	P-3	LSP4S	LCL43M

PCLNR/L-CHP

Tube connection

Lever lock toolholders – 95° approach angle.
For negative 80°/70° rhombic insert. High-pressure coolant capability.

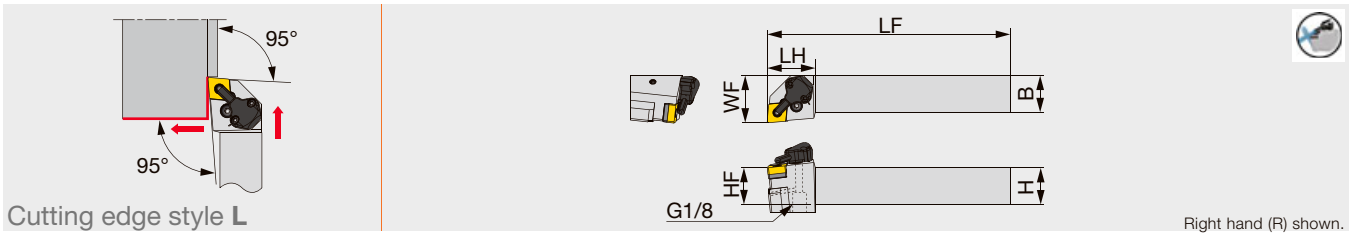

Designation	H	B	LF	LH	HF	WF	RE**	Insert	Torque*
PCLNR/L2020K0904-CHP	20	20	125	33	20	32	0.8	CN**/GNMG0904...	2
PCLNR/L2020K12-CHP	20	20	125	33	20	32	0.8	CN**/GNGA1204...	3

*Torque: Recommended torque (N·m) for clamping

**RE: Standard corner radius

SPARE PARTS

Designation	Shim	Clamping screw	Wrench 1	Spring pin	Lever
PCLNR/L**0904-CHP	LSC317	LCS3	P-2.5	LSP3	LCL33
PCLNR/L**12-CHP	LSC42	LCS4	P-3	LSP4	LCL4

SPARE PARTS

Designation	Coolant unit	Mounting screw	Wrench 2	O-ring	Coolant screw	Wrench 3
PCLNR/L**0904-CHP	CU-CW-CHP	SRM3	T-8F	OR6.4X0.9N	SRM4X4TL360	P-2
PCLNR/L**12-CHP	CU-CW-CHP	SRM3	T-8F	OR6.4X0.9N	SRM4X4TL360	P-2

Reference pages : Inserts → 2-60 -, CBN → 2-103 -, PCD → 2-128

DN

 **Rhombic, 55° with hole**

PDJNR/L

Lever-lock toolholder with 93° approach angle, for negative 55° rhombic inserts

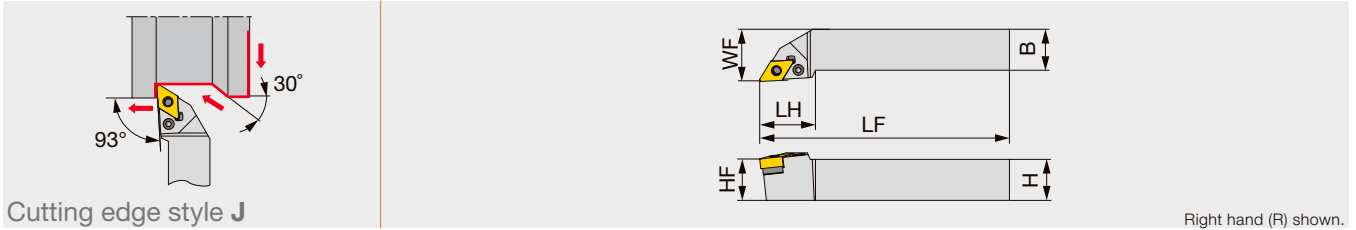

Designation	H	B	LF	LH	HF	WF	RE**	Insert	Torque*
PDJNR2020H15	20	20	100	32	20	25	0.8	DN**1504...	3

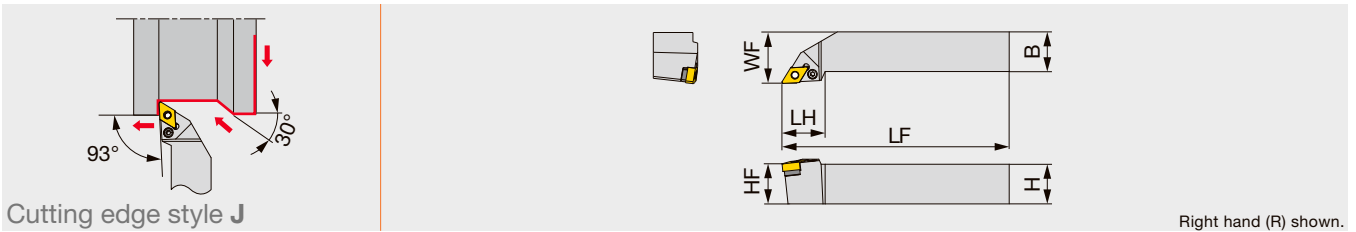





Designation	H	B	LF	LH	HF	WF	RE**	Insert	Torque*
PDJNR/L1616H1104	16	16	100	27	16	20	0.8	DN**/FNMG1104...	2
PDJNR/L1616H11	16	16	100	27	16	20	0.8	DN**/FNMG1104...	2
PDJNR/L2020K1104	20	20	125	27	20	25	0.8	DN**/FNMG1104...	2
PDJNR/L2020K11	20	20	125	27	20	25	0.8	DN**/FNMG1104...	2
PDJNR/L2020	20	20	125	34	20	25	0.8	DN**/FNGA1504...	3
PDJNR2020K15E	20	20	125	36	20	25	0.8	DN**/FNGA1506...	3
PDJNR/L2520	25	20	150	34	25	25	0.8	DN**/FNGA1504...	3

*Torque: Recommended clamping torque (N·m)

**RE: Standard corner radius

SPARE PARTS

Designation	 Shim	 Clamping screw	 Wrench	 Spring pin	 Lever
PDJNR2020H15	LSD42	LCS4	P-3	LSP4	LCL4
PDJNR/L****11/1104	ELSD32	LCS3	P-2.5	LSP3	LCL33L
PDJNR/L2020	LSD42	LCS4	P-3	LSP4	LCL4
PDJNR2020K15E	ELSD42	ELCS4	P-3	LSP4S	LCL44

Reference pages : Inserts → 2-67 -, 2-74, CBN → 2-106 -, 2-110 -, PCD → 2-128 -

Grade 1
Insert 2
Ext. Toolholder 3
Int. Toolholder 4
Threading 5
Grooving 6
Shaper 7
Endmill 8
Drilling Tool 9
Technical Reference 10

DN

 Rhombic, 55° with hole

TUNG T^{URN} JET

PDJNR/L-CHP

Tube connection

Lever lock toolholders – 93° approach angle.
For negative 55°/45° rhombic insert. High-pressure coolant capability.

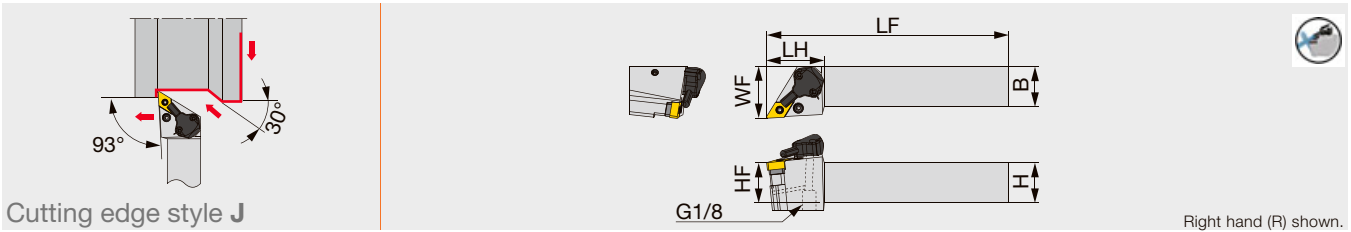

Designation	H	B	LF	LH	HF	WF	RE**	Insert	Torque*
PDJNR/L2020K1104-CHP	20	20	125	36	20	32	0.8	DN**/FNMG1104...	2
PDJNR/L2020K15-CHP	20	20	125	36	20	32	0.8	DN**/FNGA1504...	3

*Torque: Recommended torque (N-m) for clamping
**RE: Standard corner radius

SPARE PARTS

Designation	Shim	Clamping screw	Wrench 1	Spring pin	Lever
PDJNR/L**1104-CHP	ELSD32	LCS3	P-2.5	LSP3	LCL33L
PDJNR/L**15-CHP	LSD43A	LCS4	P-3	LSP4	LCL4

SPARE PARTS

Designation	Coolant unit	Mounting screw	Wrench 2	O-ring	Coolant screw	Wrench 3
PDJNR/L**1104-CHP	CU-D-CHP	SRM3	T-8F	OR6.4X0.9N	SRM4X4TL360	P-2
PDJNR/L**15-CHP	CU-D-CHP	SRM3	T-8F	OR6.4X0.9N	SRM4X4TL360	P-2

TURNING A

ADQNR/L

Double-clamp toolholder with 107.5° approach angle, for negative 55°/45° rhombic inserts

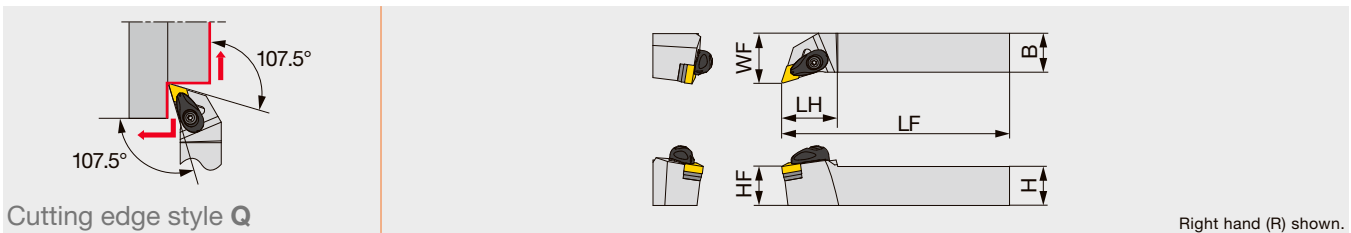

Designation	H	B	LF	LH	HF	WF	RE**	Insert	Torque*
ADQNR/L2020K1104-A	20	20	125	30	20	25	0.8	DN**/FNMG1104...	3
ADQNR/L2020K15-A	20	20	125	32	20	25	0.8	DN**/FNGA1504...	3
ADQNR/L2020K1506-A	20	20	125	32	20	25	0.8	DN**/FNGA1506...	3

*Torque: Recommended clamping torque (N-m)
**RE : Standard corner radius

VN

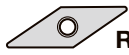

Rhombic, 35°
with hole

ISO ETURN

JPVJ2NR/L-Eco

Back-clamp toolholder with 93° approach angle, for negative 35° rhombic inserts

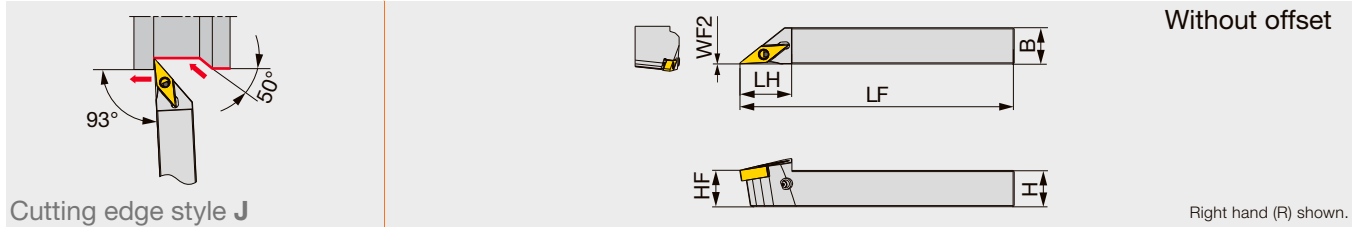

Cutting edge style J

Without offset

Right hand (R) shown.

Designation	H	B	LF	LH	HF	WF2	RE**	Insert	Torque*
JPVJ2NR/L1212X1204	12	12	120	23	12	0	0.2	VN**1204...	0.9
JPVJ2NR/L1616X1204	16	16	120	23	16	0	0.2	VN**1204...	0.9

Torque*: Recommended clamping torque (N-m)

RE**: The holder measurements are true with this insert radius

SPARE PARTS

Designation	Lever	Pin	Clamping screw	Wrench
JPVJ2NR/L**1204	SLLV-4	SL-PI-2	SR10400611	HW2.0/5RED

TUNG TJET

PVJNR/L-CHP

Tube connection

Lever lock toolholders – 93° approach angle.
For negative 35°/25° rhombic insert. High-pressure coolant capability.

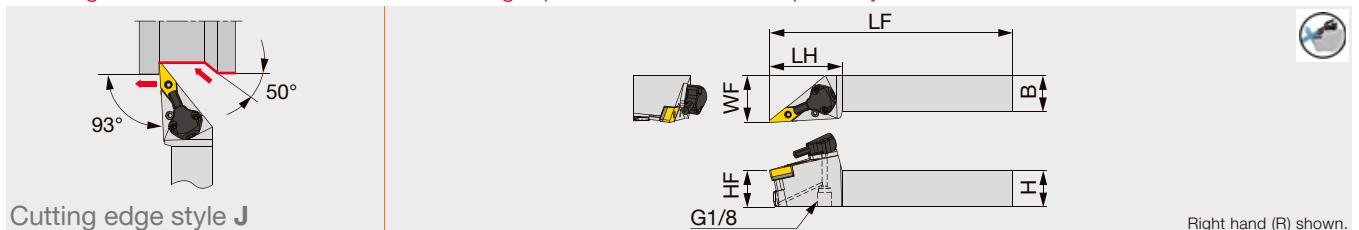

Cutting edge style J

Right hand (R) shown.

Designation	H	B	LF	LH	HF	WF	RE**	Insert	Torque*
PVJNR/L2020K1204-CHP	20	20	125	50	20	32	0.8	VN**1204...	2
PVJNR/L2020K16-CHP	20	20	125	50	20	32	0.8	VN**/YN**1604...	2

*Torque: Recommended torque (N-m) for clamping

**RE: Standard corner radius

SPARE PARTS

Designation	Shim	Clamping screw	Wrench 1	Spring pin	Lever
PVJNR/L**1204-CHP	LSV212	LCS3V	P-2.5	LSP3	LCL3V
PVJNR/L**16-CHP	LSV317	LCS3V	P-2.5	LSP3	LCL3V

SPARE PARTS

Designation	Coolant unit	Mounting screw	Wrench 2	O-ring	Coolant screw	Wrench 3
PVJNR/L**1204-CHP	CU-V-CHP	SRM3	T-8F	OR6.4X0.9N	SRM4X4TL360	P-2
PVJNR/L**16-CHP	CU-V-CHP	SRM3	T-8F	OR6.4X0.9N	SRM4X4TL360	P-2

Reference pages : Inserts → 2-83 -, 2-86, CBN → 2-116 -, 2-117 -, PCD → 2-130

Grade
Insert
Ext. Toolholder
Int. Toolholder
Threading
Grooving
Shaper
Endmill
Drilling Tool
Technical Reference

VN

Rhombic, 35° with hole

TURNINGA

AVVNN

Double-clamp toolholder with 72.5° approach angle, for negative 35°/25° rhombic inserts

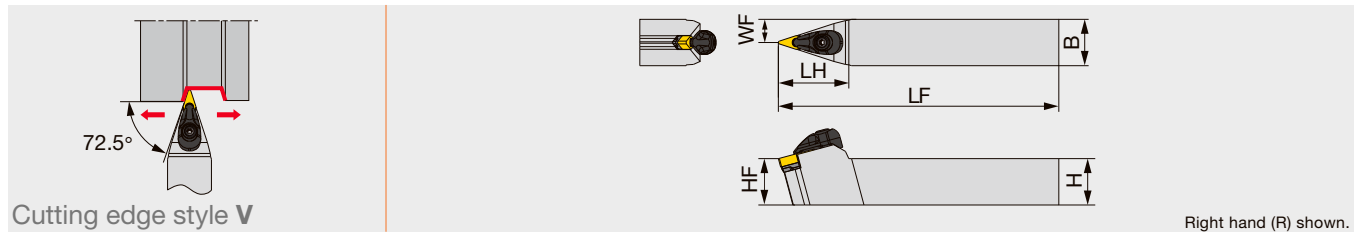

Right hand (R) shown.

Designation	H	B	LF	LH	HF	WF	RE**	Insert	Torque*
AVVNN2020K1204-A	20	20	125	38	20	10	0.8	VN**1204...	3
AVVNN2020K16-A	20	20	125	46	20	10	0.8	VN**/YN**1604...	3

*Torque: Recommended clamping torque (N-m) **RE: Standard corner radius

SPARE PARTS							
Designation	Clamp	Clamp screw	Spring	Spring pin	Shim	Shim screw	Wrench
AVVNN**1204-A	ACP3L-E	ACS-5W	BP-7	SP-2.5	ASV222	CSTB-3.0	T-15F
AVVNN**16-A	ACP3L	ACS-5W	BP-7	SP-2.5	ASV322	CSTB-3.5	T-15F

TUNG T^{URN}JET

PVQNR/L-CHP

Tube connection

Lever lock toolholders – 117.5° approach angle.
For negative 35°/25° rhombic insert. High-pressure coolant capability.

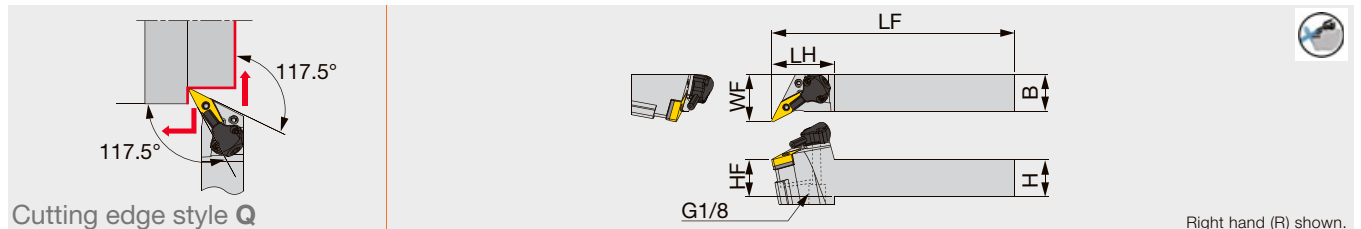

Right hand (R) shown.

Designation	H	B	LF	LH	HF	WF	RE**	Insert	Torque*
PVQNR/L2020K16-CHP	20	20	125	42.5	20	32	0.8	VN**/YN**1604...	2

*Torque: Recommended torque (N-m) for clamping
**RE: Standard corner radius

SPARE PARTS					
Designation	Shim	Clamping screw	Wrench 1	Spring pin	Lever
PVQNR/L**16-CHP	LSV317	LCS3V	P-2.5	LSP3	LCL3V

SPARE PARTS						
Designation	Coolant unit	Mounting screw	Wrench 2	O-ring	Coolant screw	Wrench 3
PVQNR/L**16-CHP	CU-V-CHP	SRM3	T-8F	OR6.4X0.9N	SRM4X4TL360	P-2

Reference pages : Inserts → 2-83 -, 2-86, CBN → 2-116 -, 2-117 -, PCD → 2-130

YW

Rhombic, 25°
with hole
Positive 7°

Y-PRO SERIES

SYJBR/L

Screw-on toolholder with 93° approach angle, for positive 25° rhombic inserts

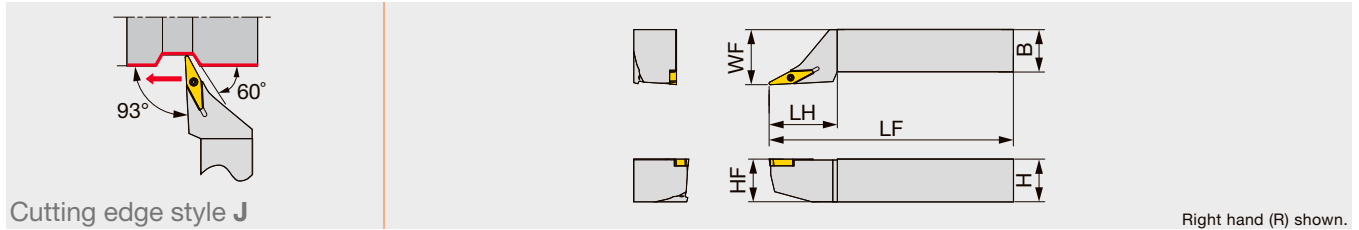

Designation	H	B	LF	LH	HF	WF	RE**	Insert
SYJBR/L2020K16	20	20	125	35	20	25	0.8	YWMT16T3...

**RE: Standard corner radius

SYHBR/L

Screw-on toolholder with 100° approach angle, for positive 25° rhombic inserts

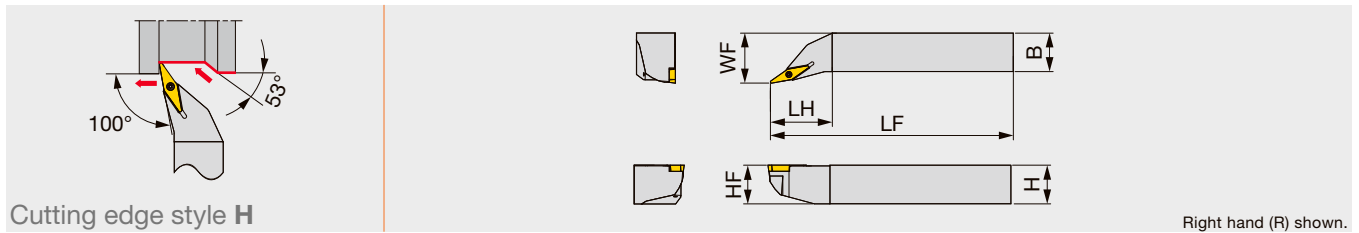

Designation	H	B	LF	LH	HF	WF	RE**	Insert
SYHBR/L2020K16	20	20	125	35	20	27	0.8	YWMT16T3...

**RE : Standard corner radius

SPARE PARTS

Designation	Clamping screw	Wrench
SYJBR/L..., SYHBR/L...,	CSTB-2.5L080	T-8F

SYIBN

Screw-on toolholder with 77.5° approach angle, for positive 25° rhombic inserts

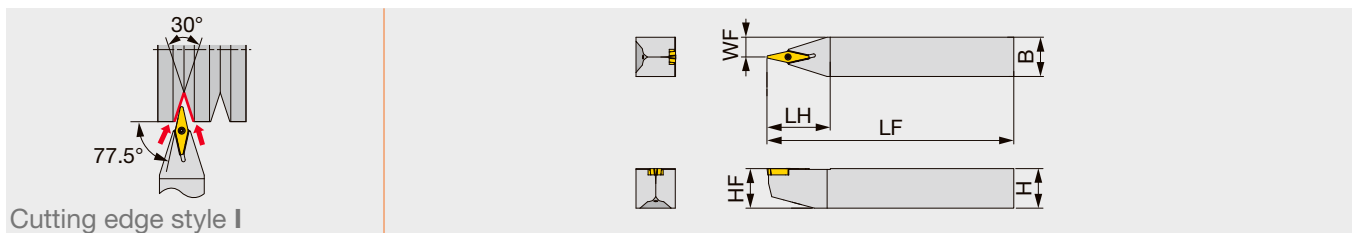

Designation	H	B	LF	LH	HF	WF	RE**	Insert
SYIBN2020K16	20	20	125	32	20	10	0.8	YWMT16T3...

**RE : Standard corner radius

Reference pages : Inserts → 2-59

Grade

Insert

Ext. Toolholder

Int. Toolholder

Threading

Grooving

Shaper

Endmill

Drilling Tool

Technical Reference

YW



Rhombic, 25°
with hole
Positive 7°

SYQBR/L

Screw-on toolholder with 122.5° approach angle, for positive 25° rhombic inserts

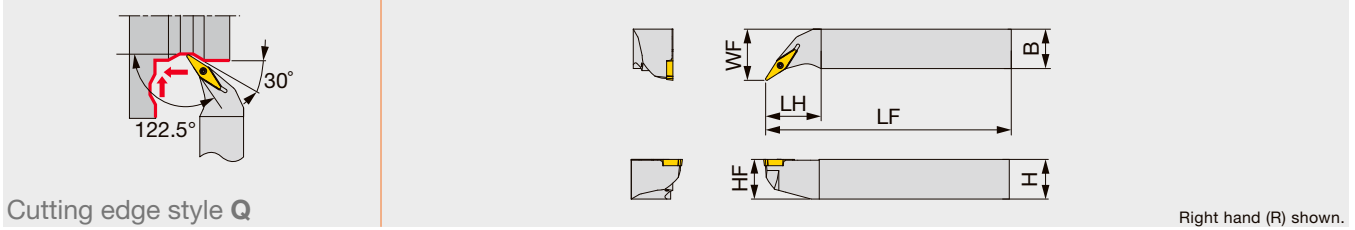

Designation	H	B	LF	LH	HF	WF	RE**	Insert
SYQBR/L2020K16	20	20	125	35	20	27	0.8	YWMT16T3...

**RE : Standard corner radius

SPARE PARTS



Designation	Clamping screw	Wrench
SYIBN..., SYQBR/L...	CSTB-2.5L080	T-8F

Parting-off and front turning toolholders

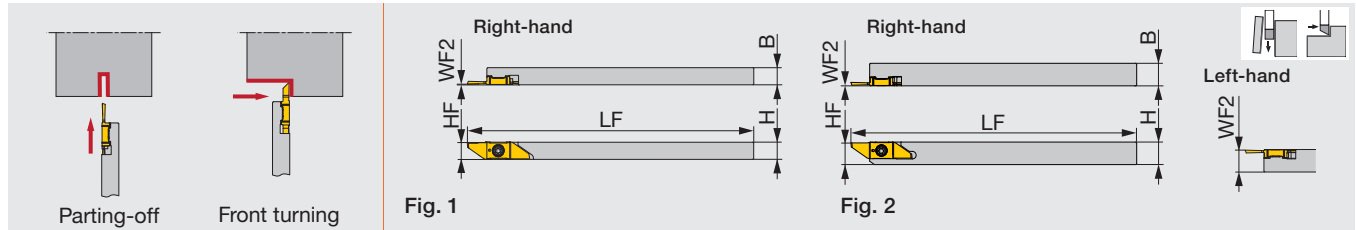

Designation	H	B	LF	HF	WF2 ⁽¹⁾	Insert	Torque*	Fig.
JSXXL0606X05	6	6	120	5.6	5.8	JV*N..., JVN...	1.3	1
JSXXR/L0707X05	7	7	120	6.6	0.2/6.8	JV*N..., JVN...	1.3	1
JSXXR/L0808F05	8	8	85	7.7	0.2/7.8	JV*N..., JVN...	1.3	2
JSXXR/L0808H05	8	8	100	7.7	0.2/7.8	JV*N..., JVN...	1.3	2
JSXXR/L1010H05	10	10	100	9.7	0.2/9.8	JV*N..., JVN...	1.3	2

Torque*: Recommended clamping torque (N·m)

(1) The first value before “/” indicates the WF for the right-hand holder and the second value after “/” for the left-hand holder.

Use the right-hand insert (JV****R...) for a right-hand holder (JSXXR...); the left-hand insert (JV****L...) for a left-hand holder (JSXXL...).

SPARE PARTS



Designation	Clamping screw	Wrench
JSXXR...05	CSTB-2.5L054DL	T-7F
JSXXL...05	CSTB-2.5L054DR	T-7F

INSERT

JVFN45R/L (For front turning)

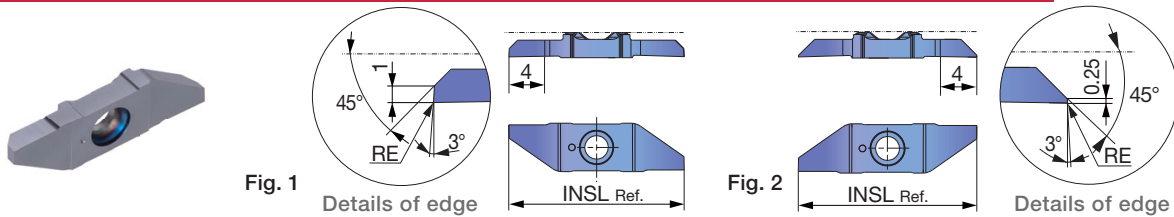

	P	M	K	N	S	H
Steel	★					
Stainless	★					
Cast iron						
Non-ferrous	★					
Superalloys	★					
Hard materials						

★ : First choice

Designation	HAND	RE	Coated					INSL	Fig.
			SH725						
JVFN45R0310F	R	0	●					21	1
JVFN45L0302FL	L	0	●					21	2

● : Line up

CSVF.. series/Toolholder

CSV

Screw-on toolholder for front turning

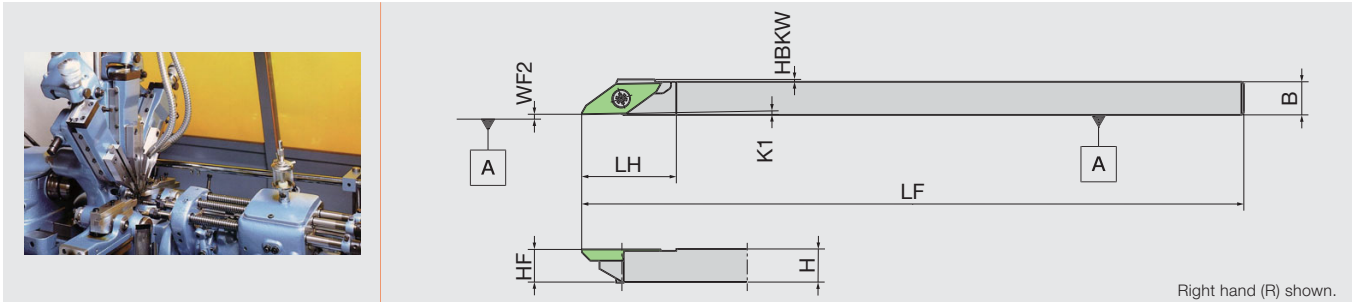

Designation	H	B	LF	LH	HBKW	HF	K1	WF2	Insert
CSVR07	7	7	140	20	0.5	7	1°	0.1	CSV series, CSVF../CSVB../CSV..../CSVG../CSV..
CSVR07GX	7	7	85	20	0.5	7	1°	0.1	CSV series, CSVF../CSVB../CSV..../CSVG../CSV..
CSVR08	8	8	140	20	0	8	1°	0.1	CSV series, CSVF../CSVB../CSV..../CSVG../CSV..
CSVR08GX	8	8	85	20	0	8	1°	0.1	CSV series, CSVF../CSVB../CSV..../CSVG../CSV..
CSVR095	9.5	9.5	140	20	0	9.5	1°	0.1	CSV series, CSVF../CSVB../CSV..../CSVG../CSV..
CSVR10	10	10	140	20	0	10	1°	0.1	CSV series, CSVF../CSVB../CSV..../CSVG../CSV..
CSVR12	12	12	140	20	0	12	1°	0.1	CSV series, CSVF../CSVB../CSV..../CSVG../CSV..
CSVR12GX	12	12	85	20	0	12	1°	0.1	CSV series, CSVF../CSVB../CSV..../CSVG../CSV..
CSVL07	7	7	140	20	0.5	7	1°	0.1	CSV series, CSVF../CSVB../CSV..../CSVG../CSV..
CSVL08	8	8	140	20	0	8	1°	0.1	CSV series, CSVF../CSVB../CSV..../CSVG../CSV..
CSVL10	10	10	140	20	0	10	1°	0.1	CSV series, CSVF../CSVB../CSV..../CSVG../CSV..

SPARE PARTS



Designation	Clamp screw	Wrench (for Clamp screw)
CSVR/L*	LRIS-2.5*7	CLR-15S

INSERT

CSVF-V without chipbreaker (For front turning)

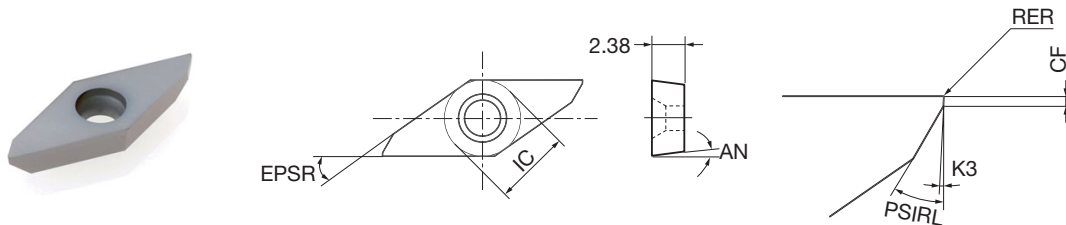

P Steel	☆	★	☆
M Stainless	★	☆	☆
N Non-ferrous	☆	☆	☆
S Superalloys	★	☆	★
H Hard materials	★	☆	☆

★ : First choice
☆ : Second choice

Designation	HAND	Coated			APMX	IC	AN	EPSR	CF	K3	PSIRL	RER	
		DT4	VM1	ZM3									
CSVF11FRV	R	●	●	●	(M)	-	6.35	7°	35°	0.3	5°	30°	0
CSVF11FRV-A	R	●	●	●	(M)	-	6.35	7°	35°	0.3	2°	30°	0
CSVF11FRV-C	R	●	●	●	(M)	-	6.35	7°	35°	0.15	5°	30°	0
CSVF11FRV-M	R	●	●	●	(M)	-	6.35	7°	35°	0.15	2°	30°	0
CSVF11FLV	L	●	●	●	(M)	-	6.35	7°	35°	0.3	5°	30°	0
CSVF11FLV-M	L	●	●	●	(M)	-	6.35	7°	35°	0.15	2°	30°	0

All angles shown are obtained when insert is set in the holder.

● : Line up

CSVF-VB with chipbreaker (For front turning)

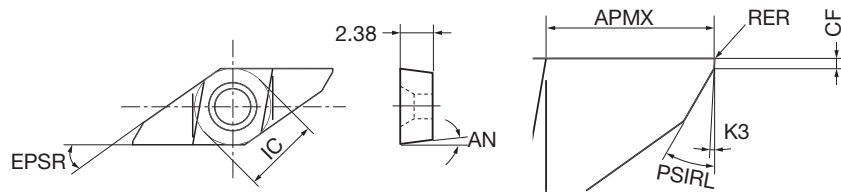

Right hand (R) shown.

P	Steel	☆	★	☆
M	Stainless	★	☆	☆
N	Non-ferrous	☆	☆	★
S	Superalloys	★	☆	☆
H	Hard materials	★	☆	☆

★ : First choice
☆ : Second choice

Designation	HAND	Coated			APMX	IC	AN	EPSR	CF	K3	PSIRL	RER	
		DT4	VM1	ZM3									
CSVF11FRVB	R		●		(M)	3	6.35	7°	35°	0.3	5°	30°	0
CSVF11FRVB-A	R		●		(M)	3	6.35	7°	35°	0.3	2°	30°	0
CSVF11FRVB-C	R		●		(M)	3	6.35	7°	35°	0.15	5°	30°	0
CSVF11FRVB-M	R	●	●	●	(M)	3	6.35	7°	35°	0.15	2°	30°	0
CSVF11FLVB	L		●		(M)	3	6.35	7°	35°	0.3	5°	30°	0
CSVF11FLVB-M	L		●		(M)	3	6.35	7°	35°	0.15	2°	30°	0

All angles shown are obtained when insert is set in the holder.

● : Line up

CSVF-VX without chipbreaker (For front turning)

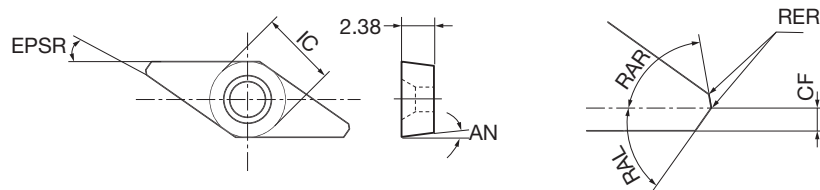
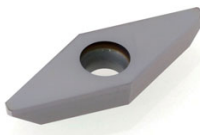

Left hand (L) shown.

P	Steel	★
M	Stainless	☆
N	Non-ferrous	☆
S	Superalloys	☆
H	Hard materials	☆

★ : First choice
☆ : Second choice

Designation	HAND	Coated		APMX	IC	AN	EPSR	CF	RAL	RAR	RER
		VM1	(M)								
CSVF11FRVX	L	●	(M)	-	6.35	7°	35°	0.7	45°	80°	0

All angles shown are obtained when insert is set in the holder.

● : Line up

Grade
Insert
Ext. Toolholder
Int. Toolholder
Threading
Grooving
Shaper
Endmill
Drilling Tool
Technical Reference

TFT-OH3

Screw-on toolholder for front turning, with high pressure coolant capability

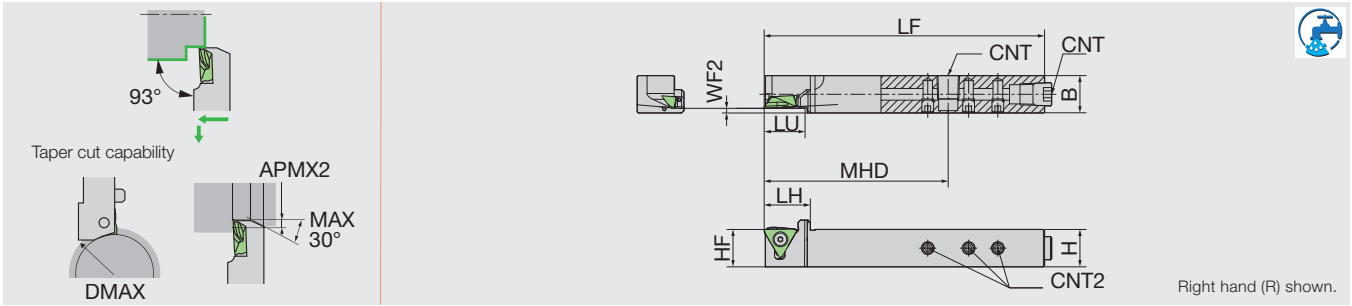

Designation	DMAX	APMX2	H	B	LF	LH	HF	LU	MHD	WF2	CNT	CNT2	Insert
TFTR1616X-OH3	40	2.5	16	16	120	19.75	16	18	78.75	2	Rc1/8	M5	TFX33.. TF33..

[Workpiece shape restrictions during machining]

DMAX: Max. bar stock diameter during APMX2 max DOC

APMX2: Max depth of cut

NOTE: Reference Chart of OH3 Hole Position → 10-1

SPARE PARTS

Designation	Clamp screw	Screw (for CNT)	Screw (for CNT2)	Wrench (for Clamp screw)	Wrench (for CNT2)
TFTR1616X-OH3	LR-S-4*10PW	SPR1/8L	SS0505SC	CLR-15S	LW-2.5

TFT-OH2

Screw-on toolholder for front turning, with high pressure coolant capability

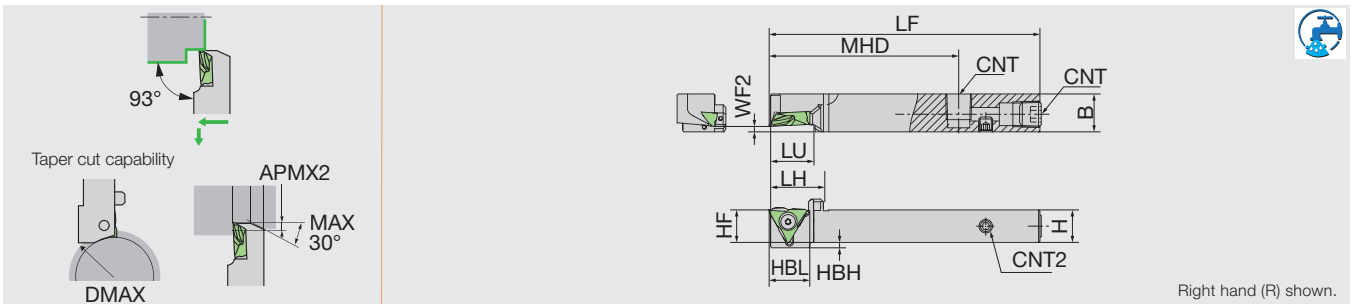

Designation	DMAX	APMX2	H	B	LF	LH	HBH	HBL	HF	LU	MHD	WF2	CNT	CNT2	Insert
TFTR1014H-OH2	20	2.5	10	14	100	20	4	15	10	15	70	2	M6*1	M5	TFX33.. TF33..
TFTR1214H-OH2	30	2.5	12	14	120	20	2	15	12	15	70	2	Rc1/8	M5	TFX33.. TF33..
TFTR1616X-OH2	40	2.5	16	16	120	20	-	-	16	17.5	70	2	Rc1/8	M5	TFX33.. TF33..

[Workpiece shape restrictions during machining]

DMAX: Max. bar stock diameter during APMX2 max DOC

APMX2: Max depth of cut

SPARE PARTS

Designation	Clamp screw	Screw (for CNT)	Screw (for CNT2)	Wrench (for Clamp screw)	Wrench (for CNT2)
TFTR1014H-OH2	LR-S-4*10PW	SS0605SC	SS0505SC	CLR-15S	LW-2.5
TFTR1214H-OH2	LR-S-4*10PW	SPR1/8	SS0505SC	CLR-15S	LW-2.5
TFTR1616X-OH2	LR-S-4*10PW	SPR1/8L	SS0505SC	CLR-15S	LW-2.5

Reference pages : Inserts → 3-94

TFT

Screw-on toolholder for front turning

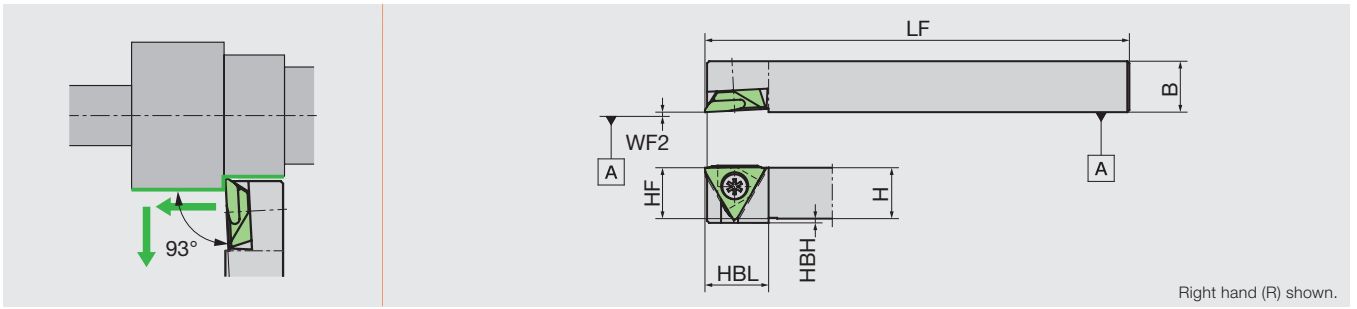

Designation	H	B	LF	HBH	HBL	HF	WF2	Insert	
TFTR10	10	10	120	3	15	10	0	TFX33..	TF33..
TFTR12	12	12	120	1	15	12	0	TFX33..	TF33..
TFTR16	16	16	120	-	-	16	0	TFX33..	TF33..
TFTR20	20	20	120	-	-	20	0	TFX33..	TF33..

SPARE PARTS



Designation	Clamp screw	Wrench (for Clamp screw)
TFTR**	LR-S-4*10PW	CLR-15S

Grade

Insert

Ext. Toolholder

Int. Toolholder

Threading

Grooving

Shaper

Endmill

Drilling Tool

Technical Reference

INSERT
TFX The Front Max

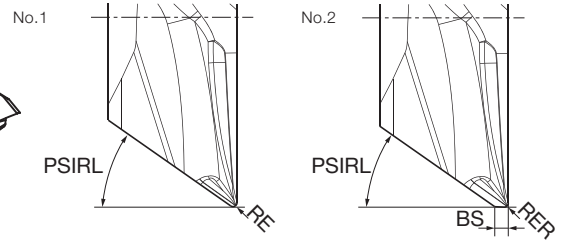
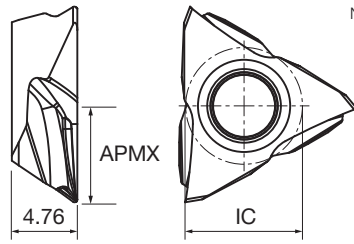

Right hand (R) shown.

P	Steel	★	☆
M	Stainless	☆	★
N	Non-ferrous		
S	Superalloys	★	
H	Hard materials	★	

★ : First choice
☆ : Second choice

Designation	Coated		Wiper	APMX	IC	BS	PSIRL	RE	RER	Figure
	DM4	ST4								
TFX3301MR	●	●	No	5	9.525	-	32°	0.08	-	1
TFX3302MR	●	●	No	5	9.525	-	32°	0.18	-	1
TFX3304MR	●	●	No	5	9.525	-	32°	0.38	-	1
TFX3301MRW	●	●	Straight	5	9.525	0.5	32°	-	0.08	2
TFX3302MRW	●	●	Straight	5	9.525	0.5	32°	-	0.18	2
TFX3304MRW	●	●	Straight	5	9.525	0.5	32°	-	0.38	2

All angles shown are obtained when insert is set in the holder.

● : Line up

TF

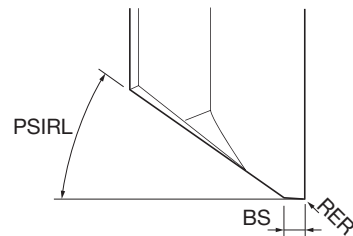
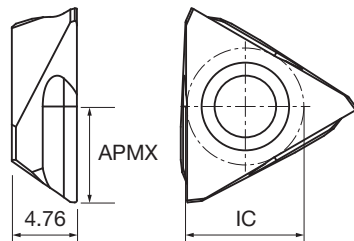

Right hand (R) shown.

P	Steel	★
M	Stainless	★
N	Non-ferrous	★
S	Superalloys	
H	Hard materials	

★ : First choice
☆ : Second choice

Designation	Coated		Wiper	APMX	IC	BS	PSIRL	RER
	ZM3							
TF3300R	●		Straight	4	9.525	0.5	32°	0
TF3305R	●		Straight	4	9.525	0.5	32°	0.05
TF3315R	●		Straight	4	9.525	0.5	32°	0.15
TF3320R	●		Straight	4	9.525	0.5	32°	0.2

All angles shown are obtained when insert is set in the holder.

● : Line up

CSV

Screw-on toolholder for back turning

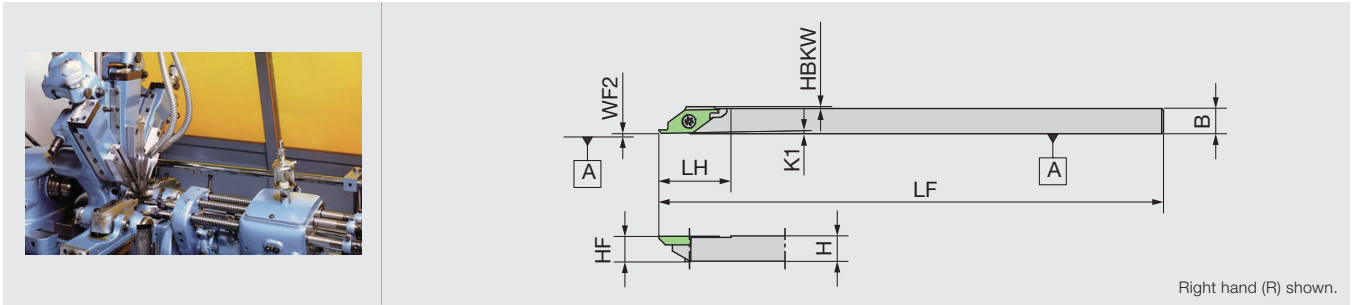

Designation	H	B	LF	LH	HBKW	HF	K1	WF2	Insert
CSVR07	7	7	140	20	0.5	7	1°	0.1	CSV series, CSVF./CSVB../CSVC../CSVG../CSVT..
CSVR07GX	7	7	85	20	0.5	7	1°	0.1	CSV series, CSVF./CSVB../CSVC../CSVG../CSVT..
CSVR08	8	8	140	20	0	8	1°	0.1	CSV series, CSVF./CSVB../CSVC../CSVG../CSVT..
CSVR08GX	8	8	85	20	0	8	1°	0.1	CSV series, CSVF./CSVB../CSVC../CSVG../CSVT..
CSVR095	9.5	9.5	140	20	0	9.5	1°	0.1	CSV series, CSVF./CSVB../CSVC../CSVG../CSVT..
CSVR10	10	10	140	20	0	10	1°	0.1	CSV series, CSVF./CSVB../CSVC../CSVG../CSVT..
CSVR12	12	12	140	20	0	12	1°	0.1	CSV series, CSVF./CSVB../CSVC../CSVG../CSVT..
CSVR12GX	12	12	85	20	0	12	1°	0.1	CSV series, CSVF./CSVB../CSVC../CSVG../CSVT..
CSVL07	7	7	140	20	0.5	7	1°	0.1	CSV series, CSVF./CSVB../CSVC../CSVG../CSVT..
CSVL08	8	8	140	20	0	8	1°	0.1	CSV series, CSVF./CSVB../CSVC../CSVG../CSVT..
CSVL10	10	10	140	20	0	10	1°	0.1	CSV series, CSVF./CSVB../CSVC../CSVG../CSVT..

SPARE PARTS



Designation	Clamp screw	Wrench (for Clamp screw)
CSVR/L**	LRIS-2.5*7	CLR-15S

INSERT

CSVB-V without chipbreaker (For back turning)

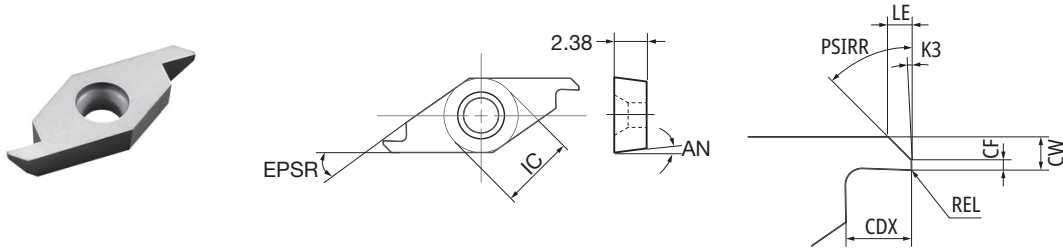

Right hand (R) shown.

P	Steel	☆	★	☆
M	Stainless	★	☆	☆
N	Non-ferrous			★
S	Superalloys	★		
H	Hard materials	★		

★ : First choice
☆ : Second choice

Designation	HAND	Coated			LE	CDX	IC	AN	EPSR	CF	CW	K3	PSIRR	REL
		DT4	VM1	ZM3										
CSVB11FRV	R		●		0.7	2	6.35	7°	35°	0.3	1	5°	45°	0
CSVB11FRV12	R		●		0.8	2	6.35	7°	35°	0.3	1.2	5°	45°	0
CSVB11FRV14	R		●		1	2	6.35	7°	35°	0.3	1.4	5°	45°	0
CSVB11FRV-A	R		●		0.7	2	6.35	7°	35°	0.3	1	2°	45°	0
CSVB11FRV-C	R		●		0.7	2	6.35	7°	35°	0.15	1	5°	45°	0
CSVB11FRV-M	R	●	●	●	0.7	2	6.35	7°	35°	0.15	1	2°	45°	0
CSVB11FLV	L		●		0.7	2	6.35	7°	35°	0.3	1	5°	45°	0
CSVB11FLV-M	L		●		0.7	2	6.35	7°	35°	0.15	1	2°	45°	0

All angles shown are obtained when insert is set in the holder.

● : Line up

CSVB-VB with chipbreaker (For back turning)

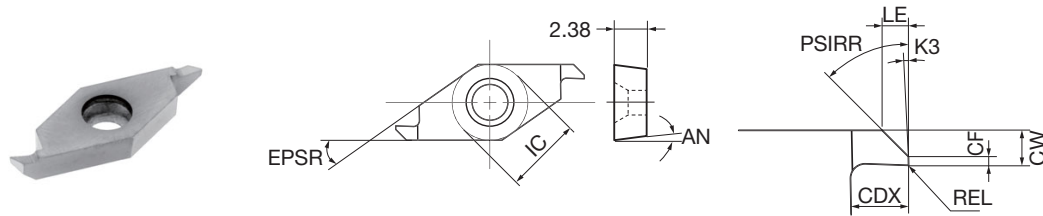

Right hand (R) shown.

P	Steel	☆	★	☆
M	Stainless	★	☆	☆
N	Non-ferrous			★
S	Superalloys	★		
H	Hard materials	★		

★ : First choice
☆ : Second choice

Designation	HAND	Coated			LE	CDX	IC	AN	EPSR	CF	CW	K3	PSIRR	REL
		DT4	VM1	ZM3										
CSVB11FRVB	R		●		0.7	2	6.35	7°	35°	0.3	1	5°	45°	0
CSVB11FRVB12	R		●		0.8	2	6.35	7°	35°	0.3	1.2	5°	45°	0
CSVB11FRVB14	R		●		1	2	6.35	7°	35°	0.3	1.4	5°	45°	0
CSVB11FRVB-A	R		●		0.7	2	6.35	7°	35°	0.3	1	2°	45°	0
CSVB11FRVB-C	R		●		0.7	2	6.35	7°	35°	0.15	1	5°	45°	0
CSVB11FRVB-M	R	●	●	●	0.7	2	6.35	7°	35°	0.15	1	2°	45°	0
CSVB11FLVB-M	L		●		0.7	2	6.35	7°	35°	0.15	1	2°	45°	0

All angles shown are obtained when insert is set in the holder.

● : Line up

CSVB-VX without chipbreaker (For back turning)

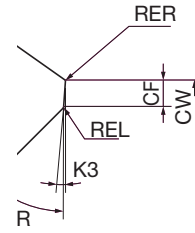
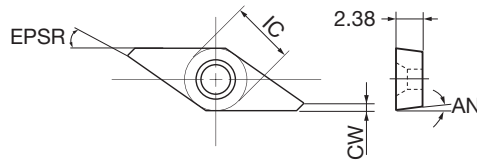
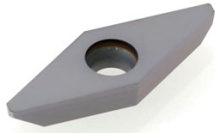

Left hand (L) shown.

P	Steel	★
M	Stainless	☆
N	Non-ferrous	
S	Superalloys	
H	Hard materials	

★ : First choice
☆ : Second choice

Designation	HAND	Coated		IC	AN	EPSR	CF	CW	K3	PSIRL	REL	RER
		VM1										
CSVB11FLVX	L	●	Ⓜ	6.35	7°	35°	0.035	0.7	5°	45°	0	0

All angles shown are obtained when insert is set in the holder.

● : Line up

- Grade 1
- Insert 2
- Ext. Toolholder 3
- Int. Toolholder 4
- Threading 5
- Grooving 6
- Shaper 7
- Endmill 8
- Drilling Tool 9
- Technical Reference 10

J-SERIES

QC12-JSEGR-CHP

Screw-on modular head for back turning, with high pressure coolant capability

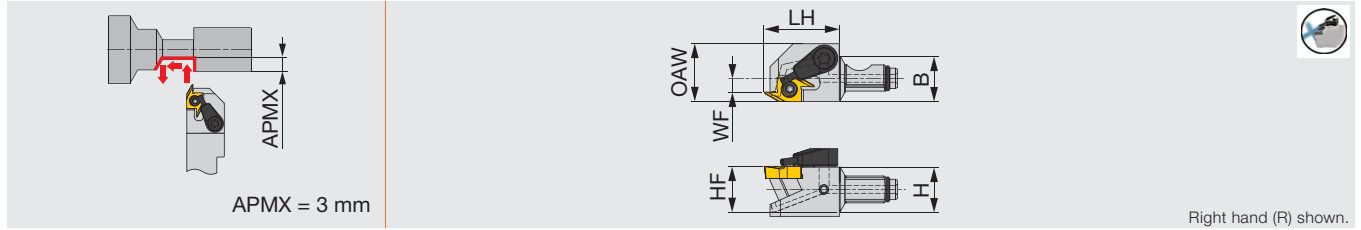

Designation	H	B	LH	HF	WF	OAW	Insert	Torque*
QC10-JSEGR10-CHP	10	10	17	10	2.5	13	J10ER...	1.2
QC12-JSEGR10-CHP	12	12	19.5	12	3.5	15	J10ER...	1.2
QC16-JSEGR10-CHP	16	16	21	16	5.5	20	J10ER...	1.2

Torque*: Recommended clamping torque (N·m)

JSEGR/L

Screw-on toolholder for back turning

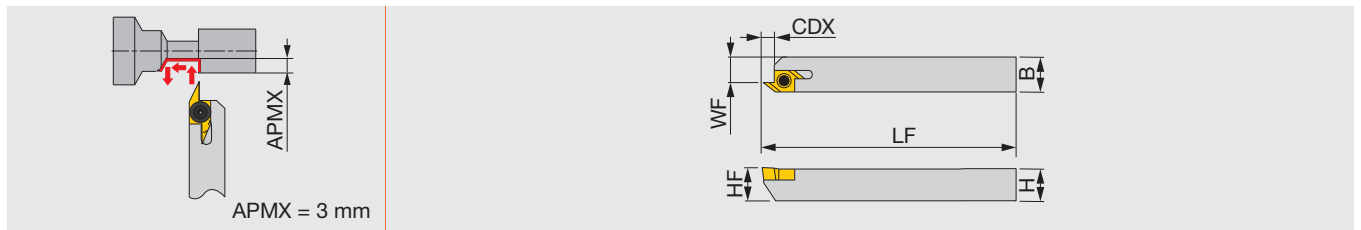

Designation	H	B	LF	CDX	HF	WF	Insert	Torque*
JSEGR/L1010K10	10	10	125	3.3	10	7.5	J10ER/L...	1.2
JSEGR/L1212K10	12	12	125	3.3	12	9.5	J10ER/L...	1.2
JSEGR/L1616K10	16	16	125	3.3	16	13.5	J10ER/L...	1.2

Torque*: Recommended clamping torque (N·m)

SPARE PARTS



Designation	Clamping screw	Coolant unit	Wrench	Wrench 2 (Optional)	O-ring
QC10-JSEGR10-CHP	CSTB-2.5	-	T-8F	-	ORSS-0353.5X1.0NBR70
QC12-JSEGR10-CHP	CSTB-2.5	S-CU-CHP	T-8F	-	ORSS-0454.5X1.0NBR70
QC16-JSEGR10-CHP	CSTB-2.5	S-CU-CHP	T-8F	-	ORSS-0757.5X1.0NBR70
JSEGR/L...	CSTB-2.5		T-8F	(T-8L)	

INSERT

J10E (Sharp edge)

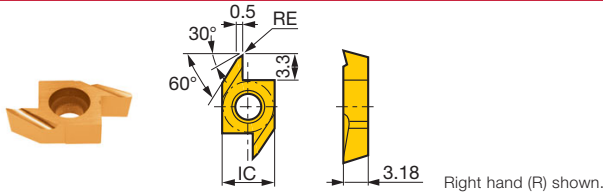

P	Steel	★	☆		★															
M	Stainless	★	☆																	
K	Cast iron	★			☆				☆											
N	Non-ferrous									★										
S	Superalloys	☆								★										
H	Hard materials									★										

★ : First choice
☆ : Second choice

Designation	HAND	RE	Coated		Cermet	Uncoated		IC	Max. depth of cut
			SH725	J740	NS9530	TH10			
J10ER/L005BF	R	0.05	●	●			●	6.35	3
J10ER/L005BF	L	0.05	●	●			●	6.35	3
J10ER/L010BF	R	0.1	●	●			●	6.35	3
J10ER/L010BF	L	0.1	●	●			●	6.35	3
J10ER/L015BF	R	0.15	●		●			6.35	3
J10ER/L015BF	L	0.15	●		●			6.35	3

● : Line up

J10E (Honed edge)

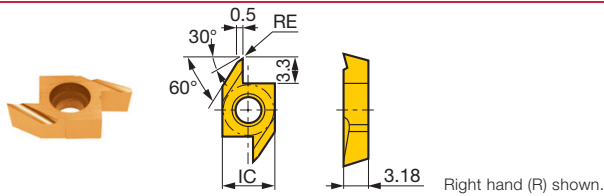

P	Steel	★			★															
M	Stainless	★																		
K	Cast iron	★			☆															
N	Non-ferrous																			
S	Superalloys	☆																		
H	Hard materials																			

★ : First choice
☆ : Second choice

Designation	HAND	RE	Coated		Coated cermet			IC	Max. depth of cut
			J740	J9530					
J10ER005B	R	0.05	●		●			6.35	3
J10EL005B	L	0.05	●					6.35	3
J10ER010B	R	0.1	●		●			6.35	3
J10EL010B	L	0.1	●					6.35	3

● : Line up

Grade
Insert
Ext. Toolholder
Int. Toolholder
Threading
Grooving
Shaper
Endmill
Drilling Tool
Technical Reference



STANDARD CUTTING CONDITIONS (J10E type insert)

ISO	Workpiece material	Grade	Cutting speed Vc (m/min)	Feed f (mm/rev)
P	Steel S45C, etc. C45, etc.	SH725	50 - 200	0.01 - 0.1
		J740	10 - 100	0.01 - 0.1
		NS9530	50 - 150	0.01 - 0.1
		J9530	50 - 150	0.01 - 0.1
	Free-cutting steel SUM22, etc. 11SMn28, etc.	SH725	50 - 200	0.01 - 0.1
		J740	10 - 100	0.01 - 0.1
M	Stainless steel SUS303, SUS304 etc. X10CrNiS18-9, etc.	SH725	50 - 200	0.01 - 0.1
		J740	10 - 100	0.01 - 0.1
		NS9530	50 - 150	0.01 - 0.1
		J9530	50 - 150	0.01 - 0.1
N	Aluminium alloys, Brass Si < 12% C3604B, etc. CW614N, etc.	TH10	10 - 200	0.01 - 0.1
S	Difficult-to-machine material, Titanium alloys Ti-6Al-4V, etc.	TH10	10 - 30	0.01 - 0.1

INSERT

10E (Insert blank)

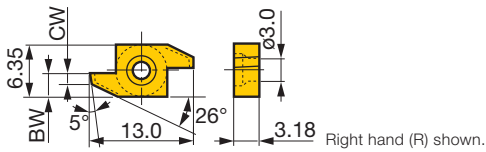

Designation	HAND	Uncoated		
		TH10		
10ER100B	R	●		
10EL100B	L	●		
10ER150B	R	●		
10EL150B	L	●		

● : Line up

Note: Right hand holder (JSEGR...) use right hand insert (10ER...) and left hand holder (JSEGL...) use left hand insert (10EL...)

10E (Insert blank)

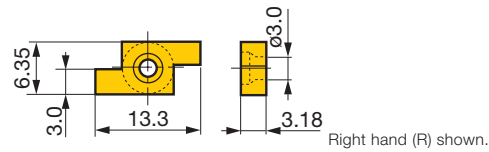

Designation	HAND	Uncoated		
		TH10		
10ER300	R	●		
10EL300	L	●		

● : Line up

Note: Right hand holder (JSEGR...) use right hand insert (10ER...) and left hand holder (JSEGL...) use left hand insert (10EL...)

Formed examples of insert blanks

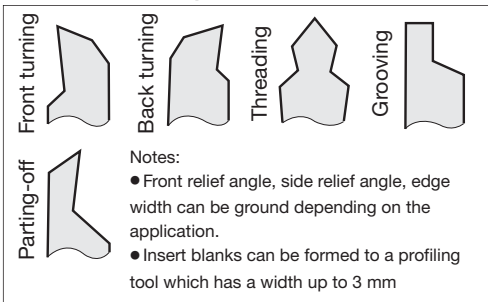

Standard cutting conditions

Operations		Workpiece material	Carbon steels	Stainless steels	Brass
Lateral feed (external turning)	Cutting speed (m/min)		~ 100	~ 50	~ 200
	Feed (mm/rev)	Roughing	~ 0.06	~ 0.03	~ 0.1
		Medium	~ 0.03	~ 0.025	~ 0.06
	Finishing	~ 0.02	~ 0.015	~ 0.04	
Parting-off Grooving Forming	Cutting speed (m/min)		~ 80	~ 30	~ 150
	Feed (mm/rev)	Roughing	~ 0.02	~ 0.015	~ 0.05
		Medium	~ 0.015	~ 0.01	~ 0.03
	Finishing	~ 0.01	~ 0.008	~ 0.015	

TBP-OH3

Screw-on toolholder for back turning, with high pressure coolant capability

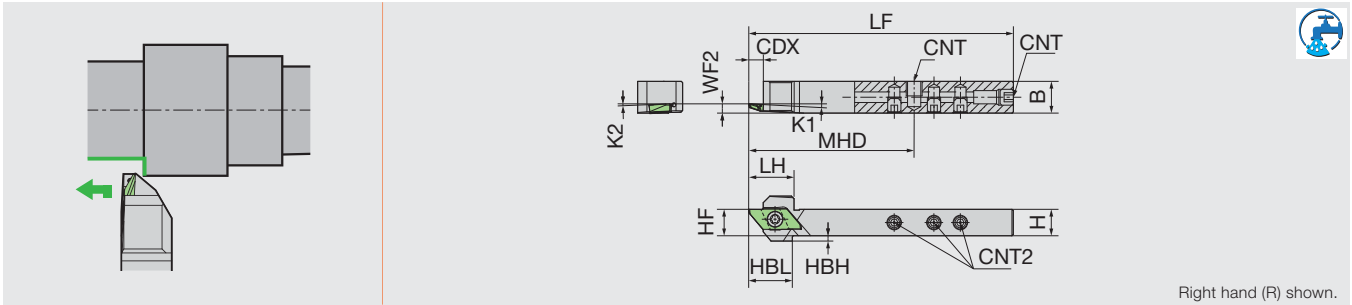

Designation	H	B	LF	LH	CDX	HBH	HBL	HF	K1	K2	MHD	WF2	CNT	CNT2	Insert
TBPR1012H-OH3	10	12	100	17.33	5.5	2	16.5	10	3°	2°	62.5	3.5	M6*1	M5	TBP..
TBPR16X-OH3	16	16	120	20	5.5	-	-	16	3°	2°	78.75	3.5	Rc1/8	M5	TBP..

NOTE: Reference Chart of OH3 Hole Position → 10-1

SPARE PARTS

Designation	Clamp screw	Screw (for CNT)	Screw (for CNT2)	Wrench (for Clamp screw)	Wrench (for CNT2)
TBPR1012H-OH3	LRIS-4*10PW	SS0605SC	SS0505SC	CLR-15S	LW-2.5
TBPR16X-OH3	LRIS-4*12PW	SPR1/8	SS0505SC	CLR-15S	LW-2.5

TBP-OH2

Screw-on toolholder for back turning, with high pressure coolant capability

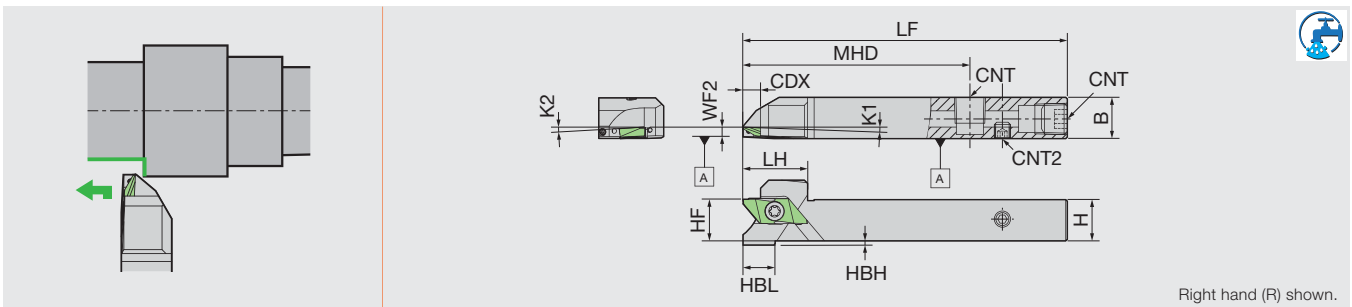

Designation	H	B	LF	LH	CDX	HBH	HBL	HF	K1	K2	MHD	WF2	CNT	CNT2	Insert
TBPR12H-OH2	12	12	100	19.5	5.5	2	10	12	3°	2°	70	3.5	Rc1/8	M5	TBP..
TBPR16X-OH2	16	16	120	19.5	5.5	-	-	16	3°	2°	70	3.5	Rc1/8	M5	TBP..

NOTE: Use a right-handed (R) or non-handed insert.

SPARE PARTS

Designation	Clamp screw	Screw (for CNT)	Screw (for CNT2)	Wrench (for Clamp screw)	Wrench (for CNT2)
TBPR**-OH2	LRIS-4*12PW	SPR1/8	SS0505SC	CLR-15S	LW-2.5

Reference pages : Inserts → 3-104 -

Grade 1
Insert 2
Ext. Toolholder 3
Int. Toolholder 4
Threading 5
Grooving 6
Shaper 7
Endmill 8
Drilling Tool 9
Technical Reference 10

TBP-OH

Screw-on toolholder for back turning, with high pressure coolant capability

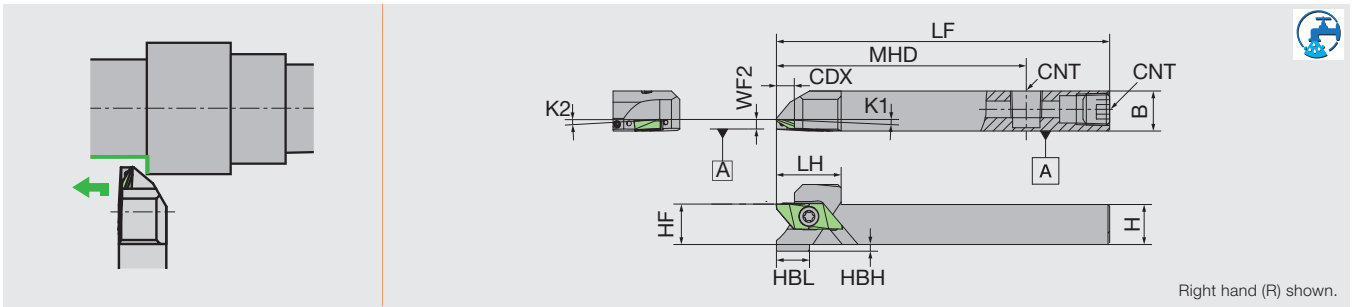

Designation	H	B	LF	HBH	HBL	HF	K1	K2	MHD	WF2	CDX	CNT	Insert
TBPR1012H-OH	10	12	100	4	19	10	3°	2°	75	3.5	5.5	M6*1	TBP..
TBPR12H-OH	12	12	100	2	10	12	3°	2°	75	3.5	5.5	Rc1/8	TBP..
TBPR16H-OH	16	16	100	-	-	16	3°	2°	75	3.5	5.5	Rc1/8	TBP..

SPARE PARTS



Designation	Clamp screw	Screw (for CNT)	Wrench (for Clamp screw)
TBPR1012H-OH	LRIS-4*10PW	SS0605SC	CLR-15S
TBPR12H-OH	LRIS-4*12PW	SPR1/8	CLR-15S
TBPR16H-OH	LRIS-4*12PW	SPR1/8	CLR-15S

TBP

Screw-on toolholder for back turning

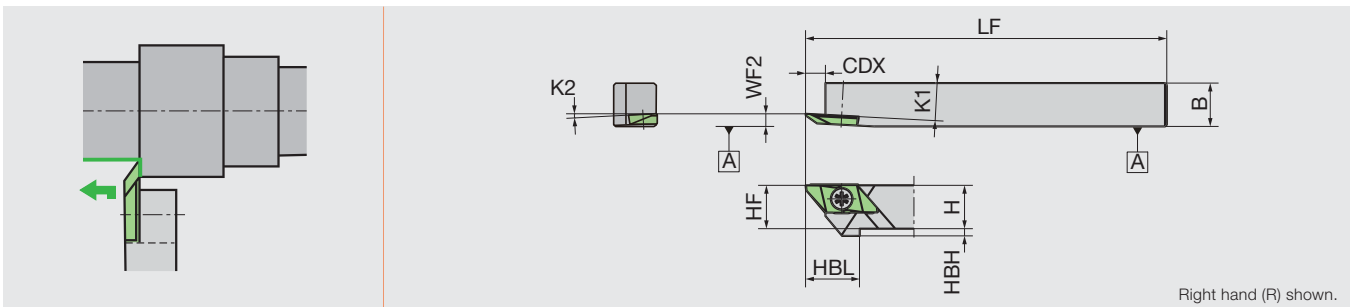

Designation	H	B	LF	HBH	HBL	HF	K1	K2	WF2	CDX	Insert
TBPR08	8	10	120	4	15	8	3°	2°	3.5	5.5	TBP..
TBPR10	10	10	120	2	15	10	3°	2°	3.5	5.5	TBP..
TBPR10H	10	10	100	2	15	10	3°	2°	3.5	5.5	TBP..
TBPR12	12	12	120	-	-	12	3°	2°	3.5	5.5	TBP..
TBPR12GX	12	12	85	-	-	12	3°	2°	3.5	5.5	TBP..
TBPR16	16	16	120	-	-	16	3°	2°	3.5	5.5	TBP..
TBPR16H	16	16	100	-	-	16	3°	2°	3.5	5.5	TBP..
TBPL08	8	10	120	4	15	8	3°	2°	3.5	5.5	TBP..
TBPL10	10	10	120	2	15	10	3°	2°	3.5	5.5	TBP..
TBPL12	12	12	120	-	-	12	3°	2°	3.5	5.5	TBP..
TBPL16	16	16	120	-	-	16	3°	2°	3.5	5.5	TBP..

SPARE PARTS



Designation	Clamp screw	Wrench (for Clamp screw)
TBPR/L08	LRIS-4*10PW	CLR-15S
TBPR/L10**	LRIS-4*10PW	CLR-15S
TBPR/L12**	LRIS-4*12PW	CLR-15S
TBPR/L16**	LRIS-4*12PW	CLR-15S

Reference pages : Inserts → 3-104 -

Y-TBP-OH

Screw-on Y-axis turning toolholder for back turning, with high pressure coolant capability

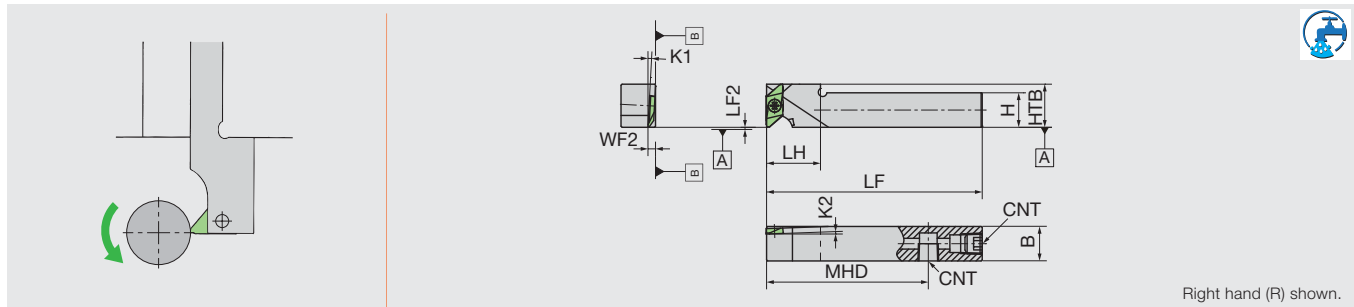

Designation	H	B	LF	LH	HTB	K1	K2	LF2	MHD	WF2	CNT	Insert
Y-TBPR12HS-OH	12	12	100	20	20	3°	2°	0	75	3.5	Rc1/8	TBP..
Y-TBPR16H-OH	16	16	100	25	20	3°	2°	0	75	3.5	Rc1/8	TBP..

NOTE: Use a right-handed (R) insert.

NOTE: There is a risk of interference with the Y-axis holder depending on the combination of the maximum workpiece diameter and machining diameter. →10-1

Y-TBP

Screw-on Y-axis turning toolholder for back turning

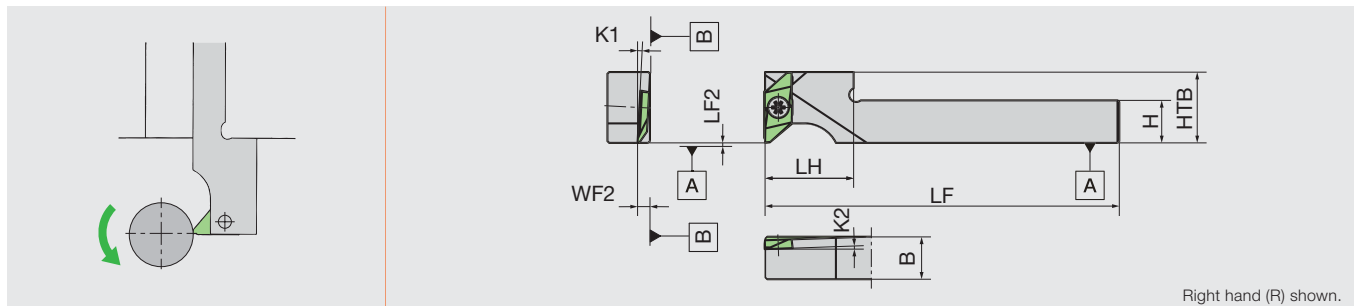

Designation	H	B	LF	LH	HTB	K1	K2	LF2	WF2	Insert
Y-TBPR10MS	10	10	120	22	20	3°	2°	0	3.5	TBP..
Y-TBPR10S	10	10	120	20	20	3°	2°	0	3.5	TBP..
Y-TBPR12MS	12	12	120	22	20	3°	2°	0	3.5	TBP..
Y-TBPR12S	12	12	120	20	20	3°	2°	0	3.5	TBP..

NOTE: Use a right-handed (R) insert.

NOTE: There is a risk of interference with the Y-axis holder depending on the combination of the maximum workpiece diameter and machining diameter. →10-1

DS-TBP

DS Toolholders / For sleeve tool post

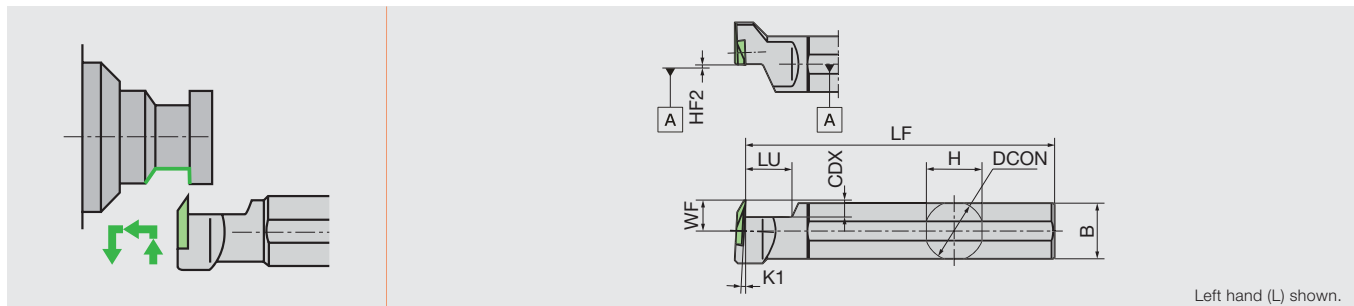

Designation	H	B	LF	CDX	DCON	HF2	K1	K2	LU	WF	Insert
DS-TBPL19	18	18	120	5.5	19.05	0	3°	2°	14	10	TBP..
DS-TBPL20	19	19	120	5.5	20	0	3°	2°	14	10	TBP..
DS-TBPL25	24	24	150	5.5	25.4	0	3°	2°	14	10	TBP..

NOTE: Use a right-handed (R) insert.

SPARE PARTS

Designation	Clamp screw	Clamp screw 1	Screw (for CNT)	Wrench (for Clamp screw)	Wrench 1 (for Clamp screw)
Y-TBPR** -OH	LRIS-4*12PW	-	SPR1/8	CLR-15S	-
Y-TBPR10**, Y-TBPR12MS	LRIS-4*10PW	-	-	CLR-15S	-
Y-TBPR12S	LRIS-4*12PW	-	-	CLR-15S	-
DS-TBPL**	-	LRIS-4*10	-	-	LLR-25S-20*65

Reference pages : Inserts → 3-104 -

Grade

Insert

Ext. Toolholder

Int. Toolholder

Threading

Grooving

Shaper

Endmill

Drilling Tool

Technical Reference

INSERT TBP with BM-Chipbreaker

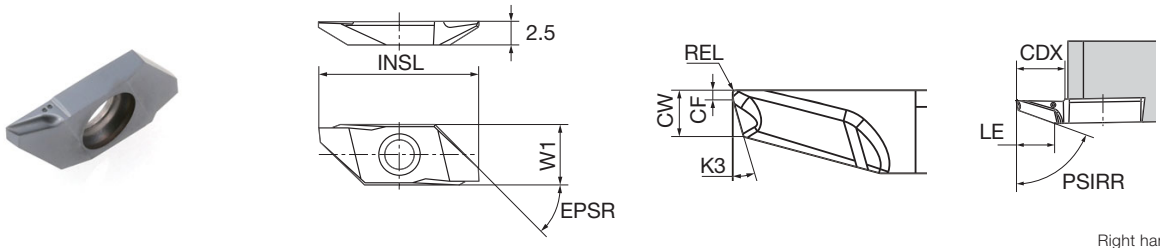

Right hand (R) shown.

P	Steel	★	☆	☆
M	Stainless	☆	★	☆
N	Non-ferrous	☆	☆	★
S	Superalloys	★	☆	☆
H	Hard materials	★	☆	☆

★ : First choice
☆ : Second choice

Designation	HAND	Coated			LE	CDX	INSL	W1	EPSR	CF	CW	K3	PSIRR	REL
		DM4	ST4	TM4										
TBP72FR05-BM	R	●	●	●	3.5	5.3	20	8	50°	0.3	1.4	16°	72°	0.05
TBP72FR10M-BM	R	●	●	●	3.5	5.3	20	8	50°	0.3	1.4	16°	72°	0.08
TBP72FR20M-BM	R	●	●	●	3.5	5.3	20	8	50°	0.3	1.4	16°	72°	0.18

● : Line up

TBP with Chipbreaker

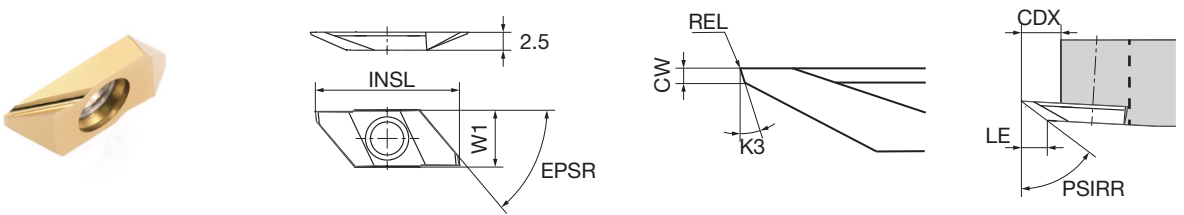

Right hand (R) shown.

P	Steel	★	☆	☆	★	☆
M	Stainless	☆	★	★	☆	☆
N	Non-ferrous	☆	☆	★	☆	★
S	Superalloys	☆	★	☆	☆	☆
H	Hard materials	★	☆	☆	☆	☆

★ : First choice
☆ : Second choice

Designation	HAND	Coated					LE	CDX	INSL	W1	EPSR	CF	CW	K3	PSIRR	REL
		QM3	DT4	TM4	VM1	ZM3										
TBP55FR00	R				●	●	3	5.3	20	8	50°	-	0.5	15°	55°	0
TBP55FR10	R				●	●	3	5.3	20	8	50°	-	0.5	15°	55°	0.1
TBP60FR00	R	●	●	●	●	●	3.7	5.3	20	8	50°	-	0.5	15°	60°	0
TBP60FR10	R	●		●	●	●	3.7	5.3	20	8	50°	-	0.5	15°	60°	0.1
TBP60FR10M	R	●	●		●		3.7	5.3	20	8	50°	-	0.5	15°	60°	0.08
TBP60FR20	R			●			3.7	5.3	20	8	50°	-	0.5	15°	60°	0.2
TBP55FL00	L					●	3	5.3	20	8	50°	-	0.5	15°	55°	0
TBP55FL10	L					●	3	5.3	20	8	50°	-	0.5	15°	55°	0.1
TBP60FL00	L					●	3.7	5.3	20	8	50°	-	0.5	15°	60°	0
TBP60FL10	L					●	3.7	5.3	20	8	50°	-	0.5	15°	60°	0.1

● : Line up

TBP-V without Chipbreaker

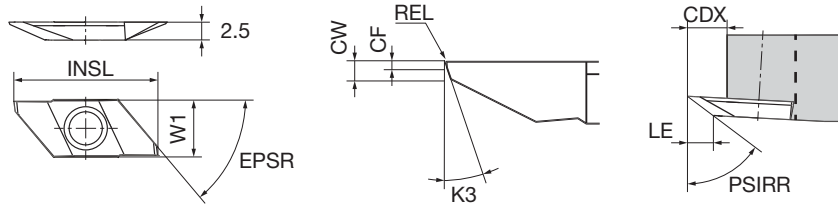

P	Steel	★	☆	
M	Stainless	☆	★	
N	Non-ferrous		☆	★
S	Superalloys			
H	Hard materials			

★ : First choice
☆ : Second choice

Designation	HAND	Coated			M	LE	CDX	INSL	W1	EPSR	CF	CW	K3	PSIRR	REL
		VM1	ZM3	KM1											
TBP60FRV	R	●	●	●	Ⓜ	4.8	5.3	20	8	50°	0.2	0.7	15°	60°	0
TBP60FRV05	R	●		●	Ⓜ	4.8	5.3	20	8	50°	0.2	0.7	15°	60°	0.05
TBP60FRV10	R	●	●	●	Ⓜ	4.8	5.3	20	8	50°	0.2	0.7	15°	60°	0.1
TBP60FLV	L	●			Ⓜ	4.8	5.3	20	8	50°	0.2	0.7	15°	60°	0

● : Line up

TBP-P PCD tipped

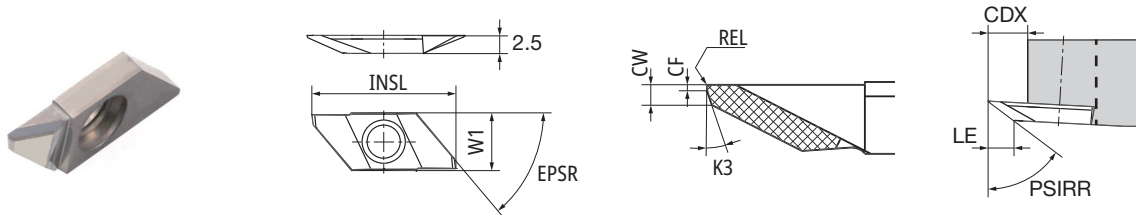

P	Steel	
M	Stainless	
N	Non-ferrous	★
S	Superalloys	
H	Hard materials	

★ : First choice
☆ : Second choice

Designation	HAND	PCD	LE	CDX	INSL	W1	EPSR	CF	CW	K3	PSIRR	REL
		PD1										
TBP60FRV00-P	R	●	4	5.3	20	8	50°	0.2	0.7	15°	60°	0
TBP60FRV10-P	R	●	4	5.3	20	8	50°	0.2	0.7	15°	60°	0.1

● : Line up

Grade
Insert
Ext. Toolholder
Int. Toolholder
Threading
Grooving
Shaper
Endmill
Drilling Tool
Technical Reference

1
2
3
4
5
6
7
8
9
10

TBPA-OH

Screw-on toolholder for back turning, with high pressure coolant capability

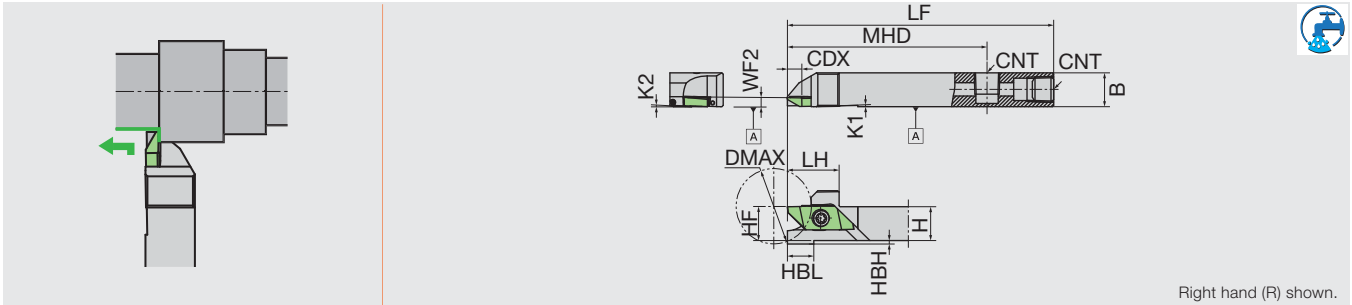

Designation	DMAX	H	B	LF	LH	CDX	HBH	HBL	HF	K1	K2	MHD	WF2	CNT	Insert
TBPAR12H-OH	25	12	12	100	19.5	6.8	4	10	12	1°	2°	75	-3.4	Rc1/8	TBPA..
TBPAR16H-OH	35	16	16	100	19.5	6.8	2	10	16	1°	2°	75	-3.4	Rc1/8	TBPA..
TBPAR20H-OH	50	20	20	100	19.5	6.8	-	-	20	1°	2°	75	-3.4	Rc1/8	TBPA..

SPARE PARTS



Designation	Clamp screw	Screw (for CNT)	Wrench (for Clamp screw)
TBPAR**-OH	LRIS-4*12PW	SPR1/8	CLR-15S

CTPA-OH2

Screw-on toolholder for back turning, with high pressure coolant capability

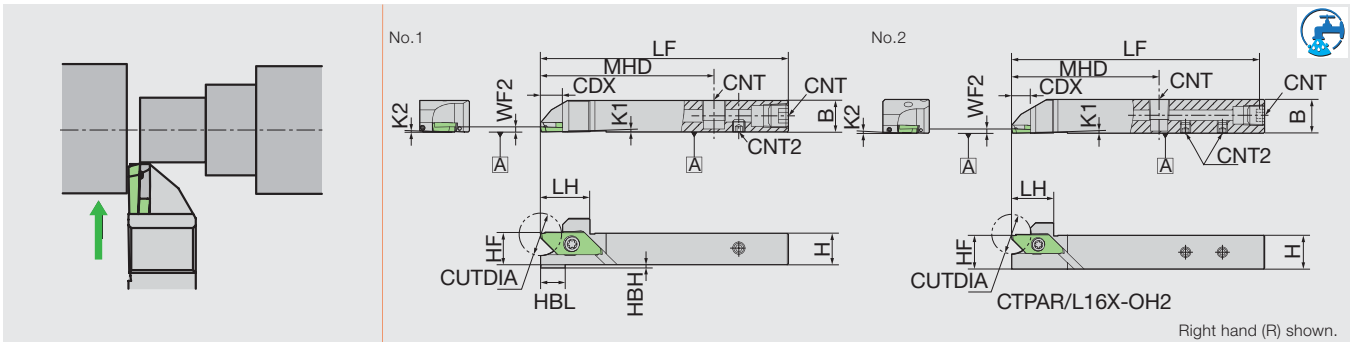

Designation	CUTDIA	H	B	LF	LH	HBH	HBL	HF	K1	K2	MHD	WF2	CNT	CNT2	Insert	Figure
CTPAR12H-OH2	16	12	12	100	19.5	2	10	12	1°	2°	70	2	Rc1/8	M5	CTPA.. TBPA..	1
CTPAR16X-OH2	16	16	16	120	19.5	-	-	16	1°	2°	70	2	Rc1/8	M5	CTPA.. TBPA..	2
CTPAL12H-OH2	16	12	12	100	19.5	2	10	12	1°	2°	70	2	Rc1/8	M5	CTPA.. TBPA..	1
CTPAL16X-OH2	16	16	16	120	19.5	-	-	16	1°	2°	70	2	Rc1/8	M5	CTPA.. TBPA..	2

SPARE PARTS



Designation	Clamp screw	Screw (for CNT)	Screw (for CNT2)	Wrench (for Clamp screw)	Wrench (for CNT2)
CTPAR**-OH2	LRIS-4*12PW	SPR1/8	SS0505SC	CLR-15S	LW-2.5

Reference pages : Inserts → **3-108 -**

CTPA-OH

Screw-on toolholder for back turning, with high pressure coolant capability

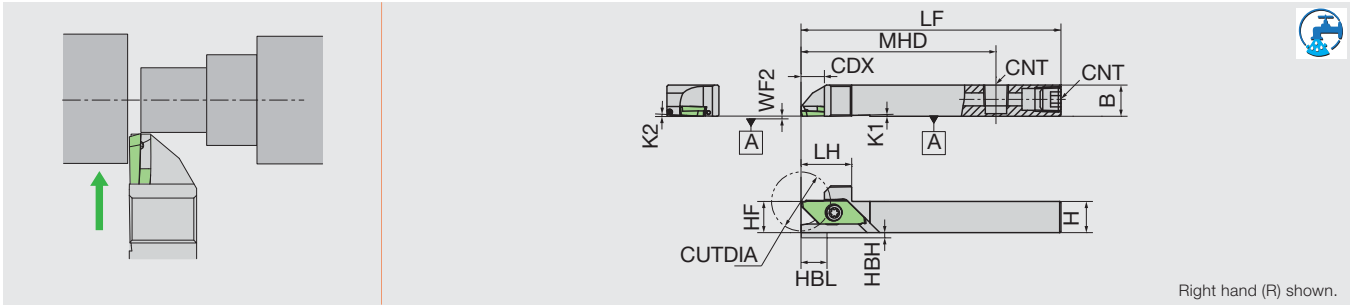

Designation	CUTDIA	H	B	LF	LH	HBH	HBL	HF	K1	K2	MHD	WF2	CNT	Insert	
CTPAL12H-OH	16	12	12	100	19.5	2	10	12	1°	2°	75	0	Rc1/8	CTPA..	TBPA..
CTPAL16H-OH	16	16	16	100	19.5	-	-	16	1°	2°	75	0	Rc1/8	CTPA..	TBPA..

SPARE PARTS



Designation	Clamp screw	Wrench (for Clamp screw)
CTPAL**OH	LRIS-4*12PW	CLR-15S

CTPA

Screw-on toolholder for back turning

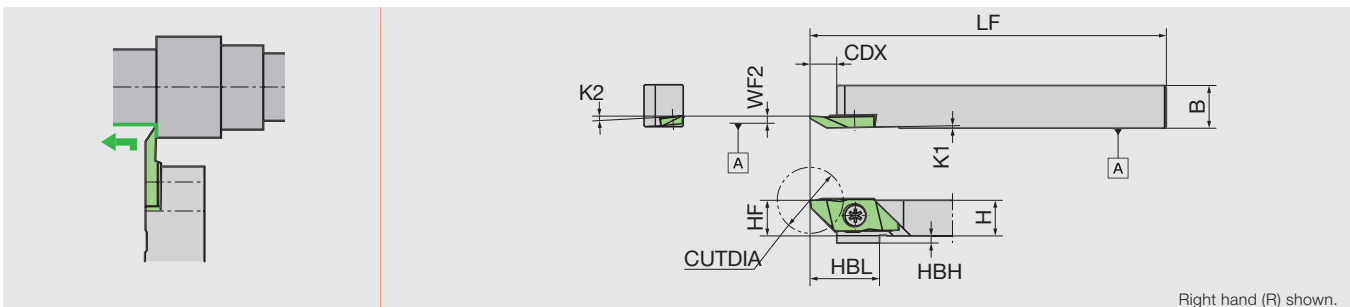

Designation	CUTDIA	H	B	LF	CDX	HBH	HBL	HF	K1	K2	WF2	Insert	
CTPAR10	16	10	10	120	7.5	2	19.5	10	1°	2°	0	CTPA..	TBPA..
CTPAR12	16	12	12	120	7.5	-	-	12	1°	2°	0	CTPA..	TBPA..
CTPAR12GX	16	12	12	85	7.5	-	-	12	1°	2°	0	CTPA..	TBPA..
CTPAR16	16	16	16	120	7.5	-	-	16	1°	2°	0	CTPA..	TBPA..
CTPAR20F	16	20	20	80	7.5	-	-	20	1°	2°	0	CTPA..	TBPA..
CTPAL10	16	10	10	120	7.5	2	19.5	10	1°	2°	0	CTPA..	TBPA..
CTPAL12	16	12	12	120	7.5	-	-	12	1°	2°	0	CTPA..	TBPA..
CTPAL12GX	16	12	12	85	7.5	-	-	12	1°	2°	0	CTPA..	TBPA..
CTPAL16	16	16	16	120	7.5	-	-	16	1°	2°	0	CTPA..	TBPA..
CTPAL20F	16	20	20	80	7.5	-	-	20	1°	2°	0	CTPA..	TBPA..

SPARE PARTS



Designation	Clamp screw	Wrench (for Clamp screw)
CTPAR/L10	LRIS-4*10PW	CLR-15S
CTPAR/L112**	LRIS-4*12PW	CLR-15S
CTPAR/L116	LRIS-4*12PW	CLR-15S
CTPAR/L120F	LRIS-4*10	LLR-25S

Reference pages : Inserts → 3-108 -

Grade
Insert
Ext. Toolholder
Int. Toolholder
Threading
Grooving
Shaper
Endmill
Drilling Tool
Technical Reference

CH-TBPA

Screw-on toolholder for back turning for horizontal gang style tool post

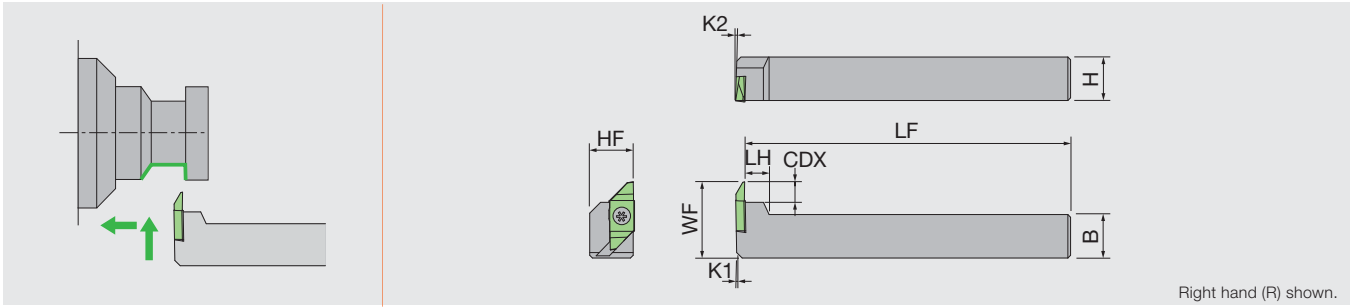

Designation	H	B	LF	LH	CDX	HF	K1	K2	WF	Insert
CH-TBPAL16	16	16	120	9	7.5	16	1°	2°	28	TBPA..
CH-TBPAL20	20	20	120	9	7.5	20	1°	2°	32	TBPA..

NOTE: Use a right-handed insert.

SPARE PARTS



Designation	Clamp screw	Wrench (for Clamp screw)
CH-TBPAL**	LRIS-4*10	LLR-25S

INSERT

TBPA with BM-Chipbreaker

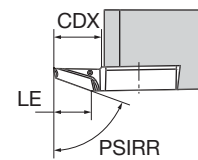
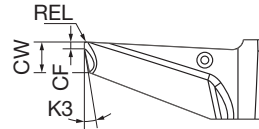
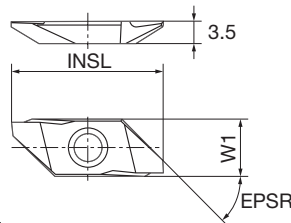

Right hand (R) shown.

P	Steel	★	☆	☆
M	Stainless	☆	★	☆
N	Non-ferrous	☆	☆	★
S	Superalloys	★	☆	☆
H	Hard materials	★	☆	☆

★ : First choice
☆ : Second choice

Designation	HAND	Coated			LE	CDX	INSL	W1	EPSR	CF	CW	K3	PSIRR	REL
		DM4	ST4	TM4										
TBPA70FR05-BM	R	●	●	●	5.5	6.5	25	9.4	45°	0.3	1.35	12°	70°	0.05
TBPA70FR10M-BM	R	●	●	●	5.5	6.5	25	9.4	45°	0.3	1.35	12°	70°	0.08
TBPA70FR20M-BM	R	●	●	●	5.5	6.5	25	9.4	45°	0.3	1.35	12°	70°	0.18

● : Line up

TBPA with Chipbreaker

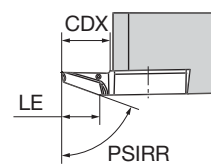
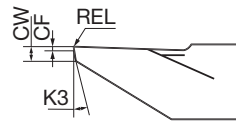
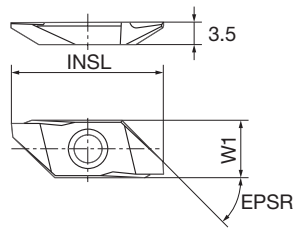
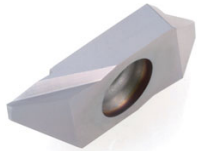

Right hand (R) shown.

P	Steel	★	☆	★	☆
M	Stainless	☆	★	☆	☆
N	Non-ferrous				★
S	Superalloys	☆	★		
H	Hard materials	★	☆		

★ : First choice
☆ : Second choice

Designation	HAND	Coated					LE	CDX	INSL	W1	EPSR	CF	CW	K3	PSIRR	REL
		QM3	DT4	VM1	ZM3											
TBPA60FR10M	R	●				Ⓜ	4.5	5.3	25	9.4	45°	0.3	0.7	15°	60°	0.08
TBPA60FRPB10	R			●	●	Ⓜ	4.5	5.3	25	9.4	45°	0.3	0.7	15°	60°	0.1
TBPA60FRPB10M	R		●	●		Ⓜ	4.5	5.3	25	9.4	45°	0.3	0.7	15°	60°	0.08
TBPA60FRPB20M	R		●	●		Ⓜ	4.5	5.3	25	9.4	45°	0.3	0.7	15°	60°	0.18
TBPA60FRVB	R		●	●	●	Ⓜ	4.5	5.3	25	9.4	45°	0.2	0.7	15°	60°	0
TBPA60FLPB10	L				●	Ⓜ	4.5	5.3	25	9.4	45°	0.3	0.7	15°	60°	0.1
TBPA60FLVB	L				●	Ⓜ	4.5	5.3	25	9.4	45°	0.2	0.7	15°	60°	0

● : Line up

TBPA-V without Chipbreaker

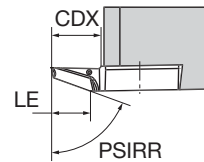
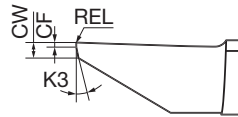
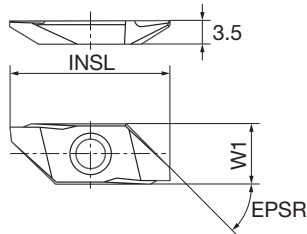

Left hand (L) shown.

P	Steel	★	★
M	Stainless	☆	★
N	Non-ferrous		★
S	Superalloys		
H	Hard materials		

★ : First choice
☆ : Second choice

Designation	HAND	Coated			LE	CDX	INSL	W1	EPSR	CF	CW	K3	PSIRR	REL
		VM1	ZM3											
TBPA60FRV	R	●	●	Ⓜ	6.3	6.8	25	9.4	45°	0.2	0.7	15°	60°	0
TBPA60FLV	L		●	Ⓜ	6.3	6.8	25	9.4	45°	0.2	0.7	15°	60°	0

● : Line up

Grade
Insert
Ext. Toolholder
Int. Toolholder
Threading
Grooving
Shaper
Endmill
Drilling Tool
Technical Reference

TBDP

Screw-on toolholder for back turning

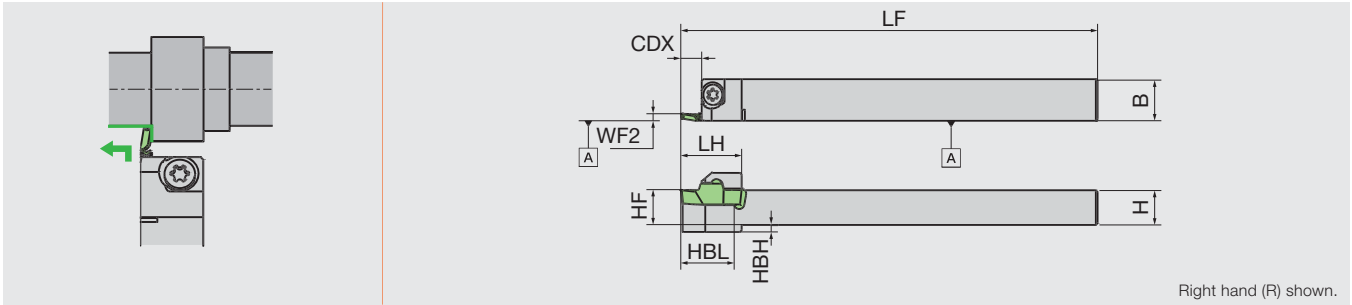

Designation	H	B	LF	LH	CDX	HBH	HBL	HF	WF2	Insert
TBDPR1012	10	12	120	15	3	2	14.5	10	2.05	TBDP..
TBDPR1012H	10	12	100	15	3	2	14.5	10	2.05	TBDP..
TBDPR12	12	12	120	18	5	-	-	12	2.05	TBDP..
TBDPR16	16	16	120	19.5	5	-	-	16	2.05	TBDP..
TBDPR20	20	20	120	19.5	5	-	-	20	2.05	TBDP..
TBDPL1012	10	12	120	15	3	2	14.5	10	2.05	TBDP..
TBDPL12	12	12	120	18	5	-	-	12	2.05	TBDP..
TBDPL16	16	16	120	19.5	5	-	-	16	2.05	TBDP..

SPARE PARTS



Designation	Clamp screw	Wrench (for Clamp screw)
TBDPR**	LRIS-4*12	LLR-25S

Y-TBDP

Screw-on Y-axis turning toolholder for back turning

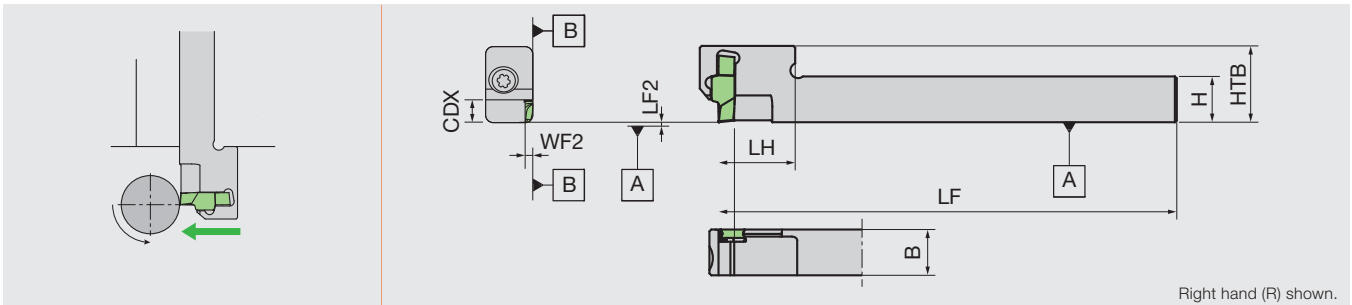

Designation	H	B	LF	LH	CDX	HTB	LF2	WF2	Insert
Y-TBDPR12S	12	12	120	20	5	20	0	2.05	TBDP..

NOTE: Use a right-handed (R) insert.

NOTE: There is a risk of interference with the Y-axis holder depending on the combination of the maximum workpiece diameter and machining diameter.

→10-1

SPARE PARTS



Designation	Clamp screw	Wrench (for Clamp screw)
Y-TBDPR12S	LRIS-4*12	LLR-25S

INSERT

TBDP

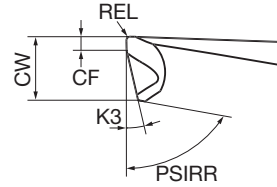
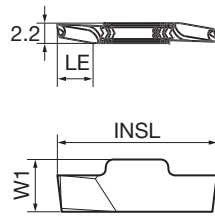

Right hand (R) shown.

P	Steel		☆	★	★
M	Stainless	★	★	☆	☆
N	Non-ferrous			☆	★
S	Superalloys		★	☆	
H	Hard materials		☆	★	

★ : First choice
☆ : Second choice

Designation	HAND	Coated				LE	INSL	W1	CF	CW	K3	PSIRR	REL
		ST4	DM4	QM3	TM4								
TBDP22005R	R	●	●	●	●	3.5	17.48	6	0.3	1.4	13°	80°	0.05
TBDP2201MR	R	●	●	●	●	3.5	17.48	6	0.3	1.4	13°	80°	0.08
TBDP2202MR	R	●	●	●	●	3.5	17.48	6	0.3	1.4	13°	80°	0.18

● : Line up

TBVC-F

Screw-on toolholder for back turning

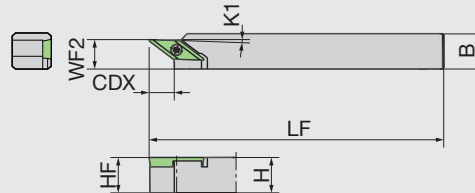
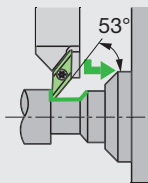

Right hand (R) shown.

Designation	H	B	LF	CDX	HF	KAPR	K1	WF2	Insert	
TBVC10-F10	10	10	120	8.5	10	53°	2°	10	TBVC11FR..	VC..1103..
TBVC12-F10	12	12	120	8.5	12	53°	2°	10	TBVC11FR..	VC..1103..
TBVC12GX-F10	12	12	85	8.5	12	53°	2°	10	TBVC11FR..	VC..1103..
TBVC16-F10	16	16	120	8.5	16	53°	2°	10	TBVC11FR..	VC..1103..
TBVC16H-F10	16	16	100	8.5	16	53°	2°	10	TBVC11FR..	VC..1103..
TBVC20F-F10	20	20	80	8.5	20	53°	2°	10	TBVC11FR..	VC..1103..

SPARE PARTS



Designation	Clamp screw	Wrench (for Clamp screw)
TBVC**	LRIS-2.5*7	CLR-15S

Reference pages : Inserts → **3-112 -**

Grade 1
Insert 2
Ext. Toolholder 3
Int. Toolholder 4
Threading 5
Grooving 6
Shaper 7
Endmill 8
Drilling Tool 9
Technical Reference 10

INSERT

TBVC..

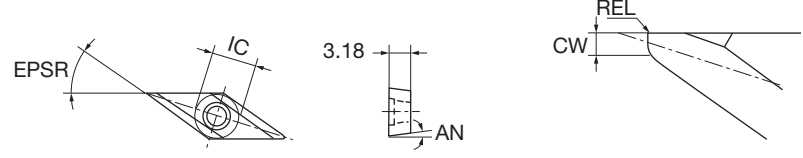

Right hand (R) shown.

P	Steel	★	★
M	Stainless	☆	★
N	Non-ferrous		★
S	Superalloys		
H	Hard materials		

★ : First choice
☆ : Second choice

Designation	HAND	Coated		IC	AN	EPSR	CW	REL
		VM1	ZM3					
TBVC11FR05U	R		●	6.35	7°	35°	0.5	0.05
TBVC11FR10S	R		●	6.35	7°	35°	0.5	0.1
TBVC11FR10U	R	●	●	6.35	7°	35°	0.5	0.1

● : Line up

CH-SVXC

Screw-on toolholder for back turning for horizontal gang style tool post

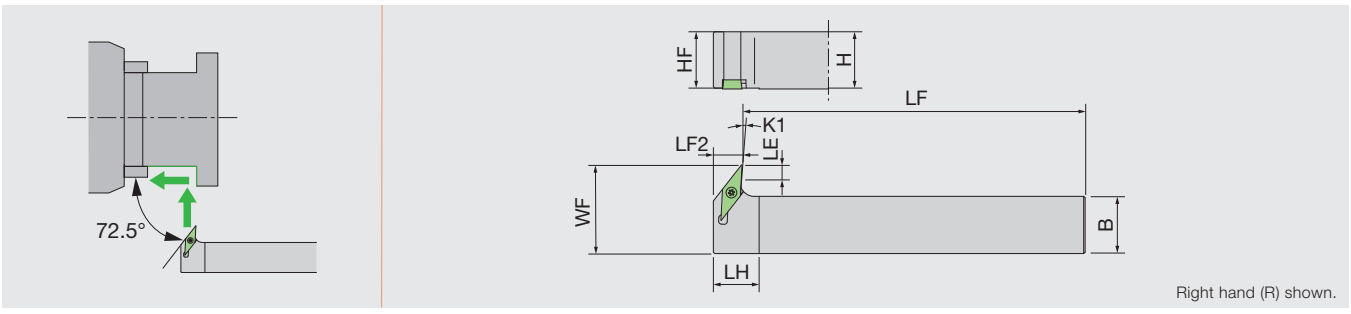

Right hand (R) shown.

Designation	H	B	LF	LH	HF	K1	LE	LF2	WF	Insert
CH-SVXCL1616X11	16	16	120	16	16	3°	7	10	27	VC..1103..
CH-SVXCL2020X11	20	20	120	16	20	3°	7	10	31	VC..1103..

SPARE PARTS



Designation	Clamp screw	Wrench (for Clamp screw)
CH-SVXCL**X11	LRIS-2.5*7	CLR-15S

Reference pages : Inserts → **3-118 -**

GTT-OH3

Screw-on toolholder for back turning, with high pressure coolant capability

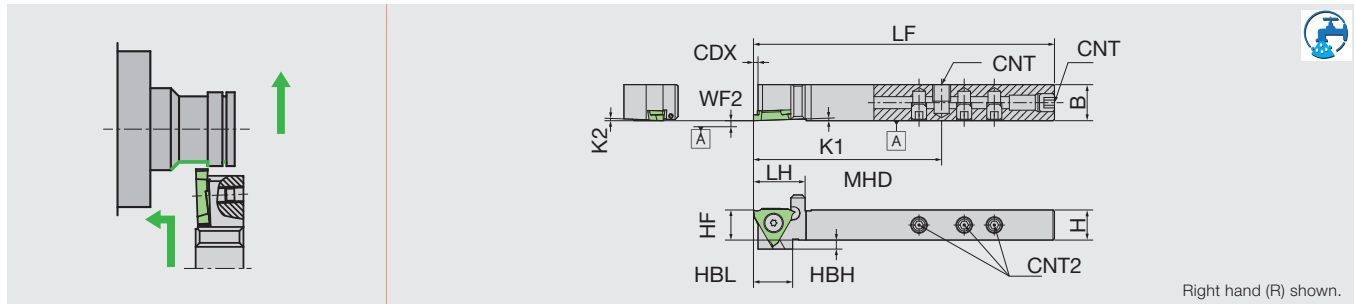

Designation	H	B	LF	LH	CDX	CW	HBH	HBL	HF	K1	K2	MHD	WF2	CNT	CNT2	Insert
GTR1012H00-OH3	10	12	100	17.15	3	0.3 - 3	3	13	10°	2°	2	62.5	0	Rc1/8	M5	GT..32.. TBMH32..
GTR16X00-OH3	16	16	120	20	3.65	0.3 - 3	-	-	16°	2°	2	78.75	0	Rc1/8	M5	GT..32.. TBMH32..

NOTE: Reference Chart of OH3 Hole Position → 10-1

SPARE PARTS

Designation	Clamp screw	Screw (for CNT)	SCREW (FOR CNT2)	Wrench (for Clamp screw)	Wrench (for CNT2)
GTR1012H00-OH3	LR-S-4*10PW	SS0605SC	SS0505SC	CLR-15S	LW-2.5
GTR16X00-OH3	LR-S-4*10PW	SPR1/8	SS0505SC	CLR-15S	LW-2.5

GTT-OH2

Screw-on toolholder for back turning, with high pressure coolant capability

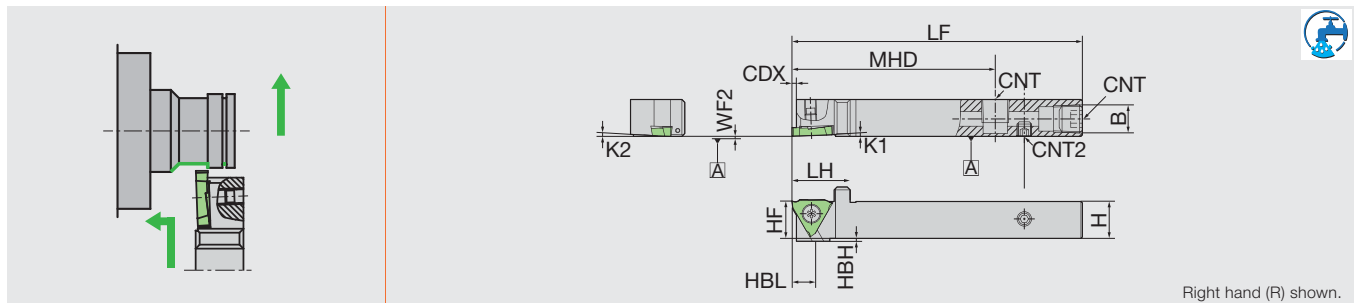

Designation	H	B	LF	LH	CDX	HBH	HBL	HF	K1	K2	MHD	WF2	CNT	CNT2	Insert
GTR12H00-OH2	12	12	100	19.5	1.6	1	13	12	2°	2°	70	0	Rc1/8	M5	GT..32.. TBMH32..
GTR16X00-OH2	16	16	120	19.5	1.6	-	-	16	2°	2°	70	0	Rc1/8	M5	GT..32.. TBMH32..

SPARE PARTS

Designation	Clamp screw	Screw (for CNT)	SCREW (FOR CNT2)	Wrench (for Clamp screw)	Wrench (for CNT2)
GTR**H00-OH2	LR-S-4*10PW	SPR1/8	SS0505SC	CLR-15S	LW-2.5

Reference pages : Inserts → 3-118 -

Grade
Insert
Ext. Toolholder
Int. Toolholder
Threading
Grooving
Shaper
Endmill
Drilling Tool
Technical Reference

GTT-OH

Screw-on toolholder for back turning, with high pressure coolant capability

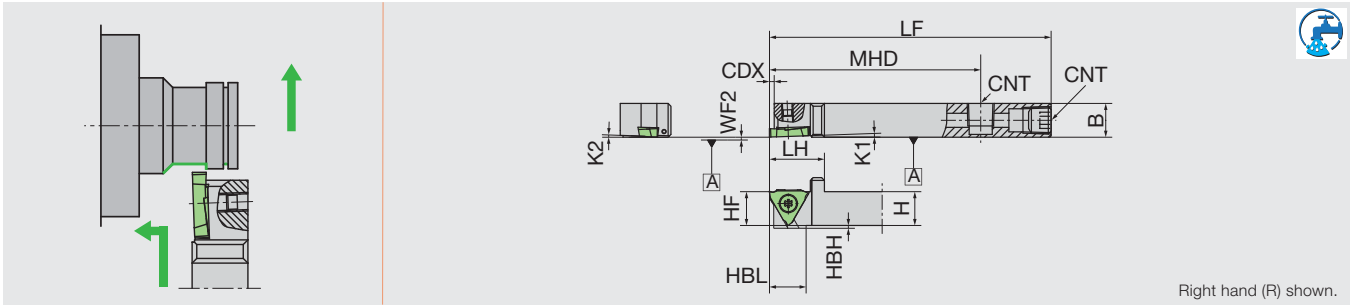

Right hand (R) shown.

Designation	H	B	LF	LH	CDX	HBH	HBL	HF	K1	K2	MHD	WF2	CNT	Insert
GTTR1012H00-OH	10	12	100	19.5	1.6	1	13	10	2°	2°	70	0	M6*1	GT..32.. TBMH32..
GTTR12H00-OH	12	12	100	19.5	1.6	1	13	12	2°	2°	70	0	Rc1/8	GT..32.. TBMH32..
GTTR16H00-OH	16	16	100	19.5	1.6	-	-	16	2°	2°	70	0	Rc1/8	GT..32.. TBMH32..

SPARE PARTS



Designation	Clamp screw	Screw (for CNT)	Wrench (for Clamp screw)
GTTR1012H00-OH	LR-S-4*10PW	SS0605SC	CLR-15S
GTTR12H00-OH	LR-S-4*10PW	SPR1/8	CLR-15S
GTTR16H00-OH	LR-S-4*10PW	SPR1/8	CLR-15S

GTT

Screw-on toolholder for back turning

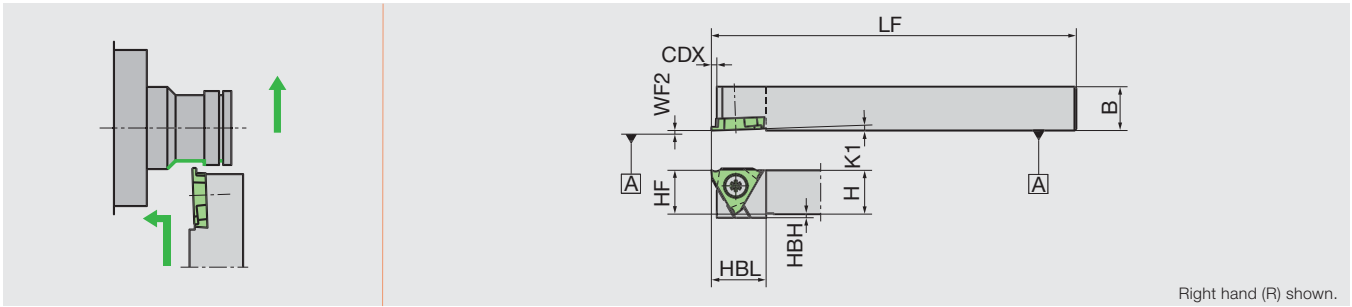

Right hand (R) shown.

Designation	H	B	LF	CDX	HBH	HBL	HF	K1	K2	WF2	Insert	
GTTR08F00	8	8	80	1.6	5	15	8	2°	2°	0	GT..32..	TBMH32..
GTTR08K00	8	8	120	1.6	5	15	8	2°	2°	0	GT..32..	TBMH32..
GTTR10F00	10	10	80	1.6	3	15	10	2°	2°	0	GT..32..	TBMH32..
GTTR10F15	10	10	80	2.7	3	15	10	2°	2°	0	GT..32..	TBMH32..
GTTR10F25	10	10	80	2.7	3	15	10	2°	2°	0	GT..32..	TBMH32..
GTTR10K00	10	10	120	1.6	3	15	10	2°	2°	0	GT..32..	TBMH32..
GTTR10K15	10	10	120	2.7	3	15	10	2°	2°	0	GT..32..	TBMH32..
GTTR10K25	10	10	120	2.7	3	15	10	2°	2°	0	GT..32..	TBMH32..
GTTR12F00	12	12	80	1.6	1	15	12	2°	2°	0	GT..32..	TBMH32..
GTTR12F15	12	12	80	2.7	1	15	12	2°	2°	0	GT..32..	TBMH32..
GTTR12F25	12	12	80	2.7	1	15	12	2°	2°	0	GT..32..	TBMH32..
GTTR12K00	12	12	120	1.6	1	15	12	2°	2°	0	GT..32..	TBMH32..
GTTR12K15	12	12	120	2.7	1	15	12	2°	2°	0	GT..32..	TBMH32..
GTTR12K25	12	12	120	2.7	1	15	12	2°	2°	0	GT..32..	TBMH32..
GTTR16H00	16	16	100	1.6	-	-	16	2°	2°	0	GT..32..	TBMH32..
GTTR16H15	16	16	100	2.7	-	-	16	2°	2°	0	GT..32..	TBMH32..
GTTR16H25	16	16	100	2.7	-	-	16	2°	2°	0	GT..32..	TBMH32..
GTTR16K00	16	16	120	1.6	-	-	16	2°	2°	0	GT..32..	TBMH32..
GTTR16K15	16	16	120	2.7	-	-	16	2°	2°	0	GT..32..	TBMH32..
GTTR16K25	16	16	120	2.7	-	-	16	2°	2°	0	GT..32..	TBMH32..
GTTR20K00	20	20	125	2.7	-	-	20	2°	2°	0	GT..32..	TBMH32..
GTTR25M00	25	25	150	2.7	-	-	25	2°	2°	0	GT..32..	TBMH32..

SPARE PARTS



Designation	Clamp screw	Wrench (for Clamp screw)
GTTR**	LR-S-4*10PW	CLR-15S

Y-GTT-OH

Screw-on Y-axis turning toolholder for back turning, with high pressure coolant capability

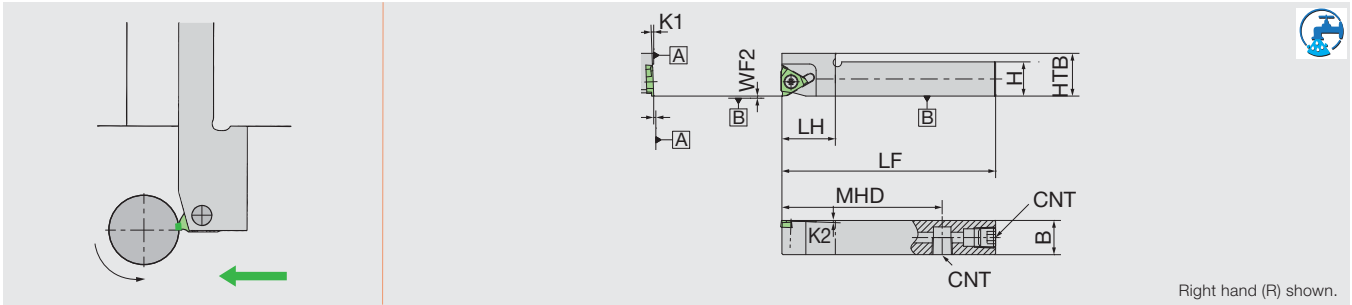

Right hand (R) shown.

Designation	H	B	LF	LH	HTB	K1	K2	LF2	MHD	WF2	CNT	Insert
Y-GTTR12H00S-OH	12	12	100	20	20	2°	2°	0	75	0	Rc1/8	GT..32.. TBMH32..
Y-GTTR16H00-OH	16	16	100	25	20	2°	2°	0	75	0	Rc1/8	GT..32.. TBMH32..

NOTE: Use a right-handed (R) insert.

NOTE: There is a risk of interference with the Y-axis holder depending on the combination of the maximum workpiece diameter and machining diameter.

→10-1

SPARE PARTS



Designation	Clamp screw	Screw (for CNT)	Wrench (for Clamp screw)
Y-GTTR**OH	LR-S-4*10PW	SPR1/8	CLR-15S

Y-GTT

Screw-on Y-axis turning toolholder for back turning

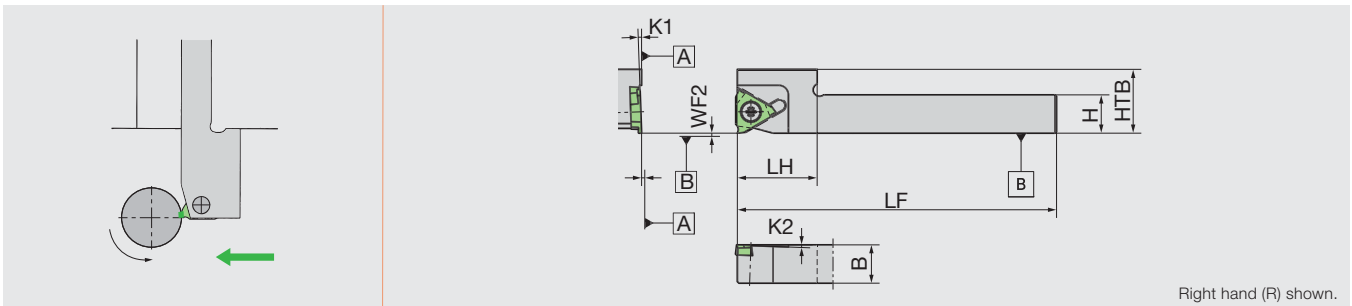

Right hand (R) shown.

Designation	H	B	LF	LH	HTB	K1	K2	LF2	WF2	Insert
Y-GTTR10MS	10	10	120	22	20	2°	2°	0	0	GT..32.. TBMH32..
Y-GTTR10S	10	10	120	20	20	2°	2°	0	0	GT..32.. TBMH32..
Y-GTTR12MS	12	12	120	22	20	2°	2°	0	0	GT..32.. TBMH32..
Y-GTTR12S	12	12	120	20	20	2°	2°	0	0	GT..32.. TBMH32..

NOTE: Use a right-handed (R) insert.

NOTE: There is a risk of interference with the Y-axis holder depending on the combination of the maximum workpiece diameter and machining diameter.

→10-1

SPARE PARTS



Designation	Clamp screw	Wrench (for Clamp screw)
Y-GTTR**	LR-S-4*10PW	CLR-15S

Reference pages : Inserts → 3-118 -

DS-GTT

Screw-on round-shank toolholder for back turning

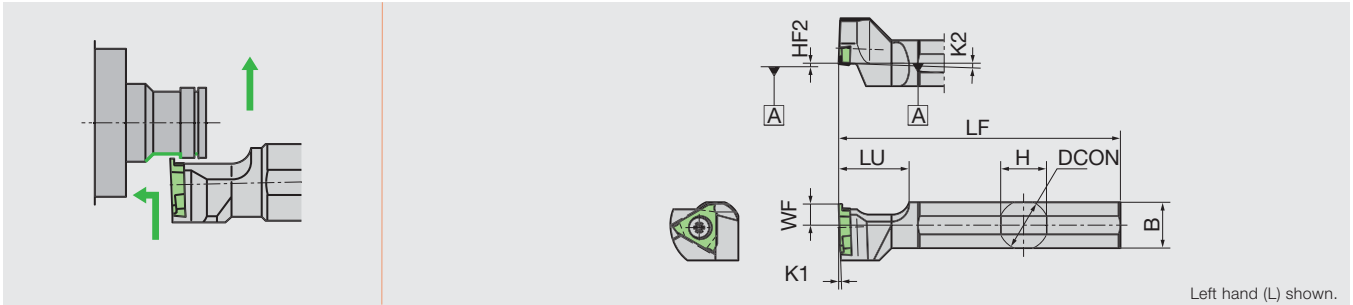

Designation	H	B	LF	DCON	HF2	K1	K2	LU	WF	Insert
DS-GTTL14F	13	13	80	14	0	2°	2°	19	6	GT..32.. TBMH32..
DS-GTTL15H	15	15	100	15.875	0	2°	2°	19	6	GT..32.. TBMH32..
DS-GTTL16X	15	15	95	16	0	2°	2°	19	6	GT..32.. TBMH32..
DS-GTTL19	18	18	120	19.05	0	2°	2°	19	6	GT..32.. TBMH32..
DS-GTTL20	19	19	120	20	0	2°	2°	19	6	GT..32.. TBMH32..
DS-GTTL22	21	21	120	22	0	2°	2°	19	6	GT..32.. TBMH32..
DS-GTTL25	24	24	120	25.4	0	2°	2°	19	10	GT..32.. TBMH32..
DS-GTTL25-MET	24	24	150	25	0	2°	2°	19	10	GT..32.. TBMH32..
DS-GTTL32	30	30	150	32	0	2°	2°	19	10	GT..32.. TBMH32..

NOTE: Use a right-handed (R) insert.

SPARE PARTS



Designation	Clamp screw	Wrench (for Clamp screw)
DS-GTTL**	LR-S-4*9	RLR-20S

CH-GTT

Screw-on toolholder for back turning for horizontal gang style tool post

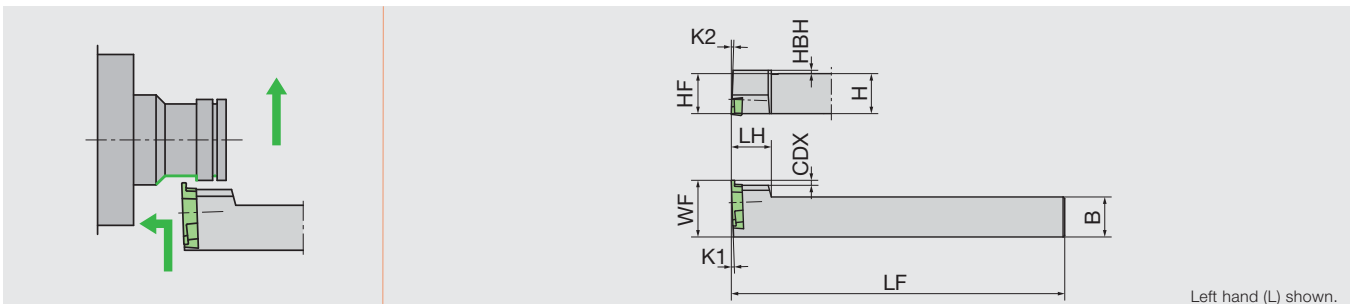

Designation	H	B	LF	LH	CDX	HBH	HF	K1	K2	WF	Insert
CH-GTTL10H00	10	10	100	12	1.5	3	10	2°	2°	15	GT..32.. TBMH32..
CH-GTTL12H00	12	12	100	12	1.5	1	12	2°	2°	17	GT..32.. TBMH32..
CH-GTTL16H00	16	16	100	12	1.5	-	16	2°	2°	21	GT..32.. TBMH32..

NOTE: Use a right-handed (R) insert.

SPARE PARTS



Designation	Clamp screw	Wrench (for Clamp screw)
CH-GTTL**H00	LR-S-4*9	RLR-20S

Reference pages : Inserts → 3-118 -

Grade

Insert

Ext. Toolholder

Int. Toolholder

Threading

Grooving

Shaper

Endmill

Drilling Tool

Technical Reference

INSERT
TBMH with Chipbreaker

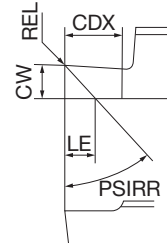
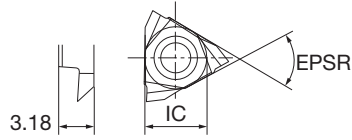
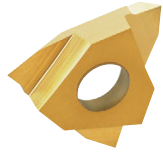

Right hand (R) shown.

P	Steel	★
M	Stainless	★
N	Non-ferrous	★
S	Superalloys	☆
H	Hard materials	☆

★ : First choice
☆ : Second choice

Designation	HAND	Coated		LE	CDX	IC	EPSR	CW	PSIRR	REL
		ZM3								
TBMH32100R05-22	R	●		0.3	1.8	9.525	60°	1	22°	0.05
TBMH32100R05-45	R	●		0.9	1.8	9.525	60°	1	45°	0.05
TBMH32150R05-22	R	●		0.5	2.7	9.525	60°	1.5	22°	0.05
TBMH32150R05-45	R	●		1.3	2.6	9.525	60°	1.5	45°	0.05

● : Line up

Technical Guide

MINIFORCE STANDARD CUTTING CONDITIONS FOR EXTERNAL TURNING

Applications	ISO	Workpiece material	Priority	Chip breaker	Grade	Cutting speed Vc (m/min)	Depth of cut ap (mm)	Feed f (mm/rev)
For swiss type automatic lathes	P	Low carbon steel SS400, etc. E275A, etc. Carbon steel S45C, etc. C45, etc. Low alloy steel SCM415, etc. 18CrMo4, etc. Alloy steel SCM440, etc. 42CrMo4, etc.	First choice	JS	SH725	50 - 180	0.1 - 3	0.03 - 0.1
			With high sharpness	JSS	SH725	50 - 180	0.1 - 1.5	0.03 - 0.1
	M	Stainless steel (Austenitic) SUS304, etc. X5CrNi18-9, etc. Stainless steel (Martensitic and ferritic) SUS430, etc. X6Cr17, etc. Stainless steel (Precipitation hardened) SUS630, etc. X5CrNiCuNb16-4, etc.	First choice	JS	SH725	50 - 180	0.1 - 1.25	0.03 - 0.1
			With high sharpness	JSS	SH725	50 - 180	0.1 - 1.5	0.03 - 0.1
For small size CNC lathes	P	Low carbon steel SS400, etc. E275A, etc. Carbon steel S45C, etc. C45, etc. Low alloy steel SCM415, etc. 18CrMo4, etc. Alloy steel SCM440, etc. 42CrMo4, etc.	First choice	SS	AH725	50 - 180	0.15 - 1.5	0.05 - 0.2
				TS	AH725	50 - 180	0.3 - 2	0.08 - 0.3
			For improved surface finish	SS	NS9530	50 - 200	0.15 - 1.5	0.05 - 0.2
				TS	NS9530	50 - 200	0.3 - 2	0.08 - 0.3
		For wear resistance	SS	GT9530	50 - 250	0.15 - 1.5	0.05 - 0.2	
		TS	GT9530	50 - 250	0.3 - 2	0.08 - 0.3		
	M	Stainless steel (Austenitic) SUS304, etc. X5CrNi18-9, etc. Stainless steel (Martensitic and ferritic) SUS430, etc. X6Cr17, etc. Stainless steel (Precipitation hardened) SUS630, etc. X5CrNiCuNb16-4, etc.	First choice	SS	AH8015	50 - 150	0.15 - 1.5	0.05 - 0.2
For impact resistance			TS	AH8015	50 - 150	0.3 - 2	0.08 - 0.3	

J-SERIES STANDARD CUTTING CONDITIONS

ISO	Workpiece material	Priority	Grade	Cutting speed Vc (m/min)	Feed f (mm/rev)
P	Low carbon steel SS400, etc. E275A, etc. Carbon steel S45C, etc. C45, etc. Low alloy steel SCM415, etc. 18CrMo4, etc. Alloy steel SCM440, etc. 42CrMo4, etc.	First choice	SH725	50 - 200	0.01 - 0.2
		For impact resistance	AH725	50 - 200	0.01 - 0.2
M	Stainless steel (Austenitic) SUS304, etc. X5CrNi18-9, etc. Stainless steel (Martensitic and ferritic) SUS430, etc. X6Cr17, etc. Stainless steel (Precipitation hardened) SUS630, etc. X5CrNiCuNb16-4, etc.	First choice	SH725	50 - 200	0.01 - 0.2
		For impact resistance	AH725	50 - 200	0.01 - 0.2
S	Titanium alloys Ti-6Al-4V, etc. Superalloys Inconel718, etc.	First choice	SH725	20 - 80	0.01 - 0.2
		For impact resistance	AH725	20 - 80	0.01 - 0.2

Grade

Insert

Ext. Toolholder

Int. Toolholder

Threading

Grooving

Shaper

Endmill

Drilling Tool

Technical Reference

SHANK

MODUM^{INI}TURN QC-1212

Shank for modular heads

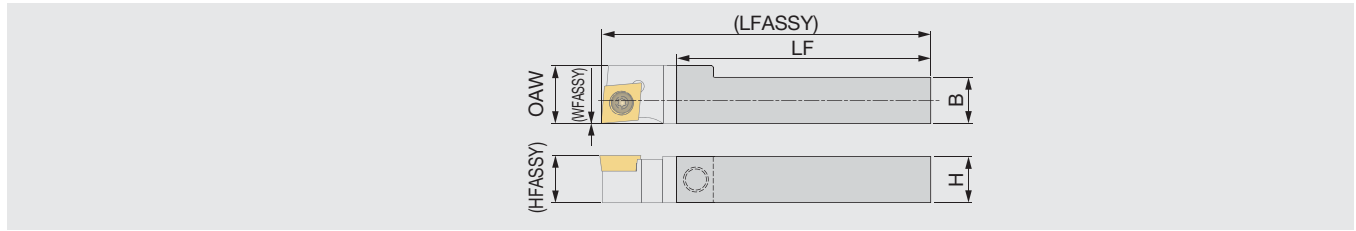

Designation	H	B	WFASSY	LF	OAW	HFASSY	LFASSY ⁽¹⁾	Torque*
QC-1212F	12	12	0	65	15	12	85	3
QC-1212X	12	12	0	100	15	12	120	3

Torque* : Recommended clamping torque (N·m)
(1) The size is true when the modular head with LH = 19,5 mm is mounted.

QC-1012/1212/1616-CHP

Shank for modular heads, with high pressure coolant capability

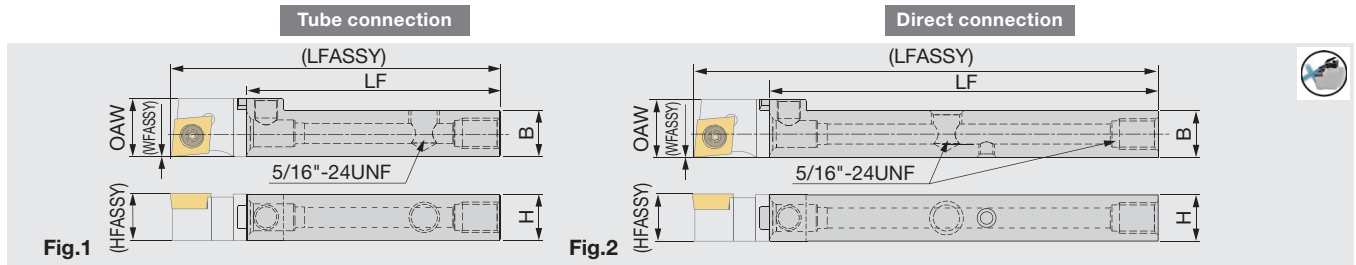

Designation	H	B	LF	WFASSY	OAW	HFASSY	LFASSY ⁽¹⁾	Torque*	Fig.
QC-1212F-CHP	12	12	65	0	15	12	85	3	1
QC-1212X-CHP ^(*)	12	12	100	0	15	12	120	3	2
QC-1012H-CHP ^(*)	10	12	83	0	13	10	100	2.5	2
QC-1616X-CHP ^(*)	16	16	99	0	20	16	120	8.5	2

Torque* : Recommended clamping torque (N·m)
Through-coolant shank
(*) : Compatible to the direct internal coolant supply system without the use of external coolant hose.
(1) The size is true when the modular head with LH = 19,5 mm is mounted.

QC-1216/1620-F15-CHP

Stepped-head shank for modular heads, with high pressure coolant capability

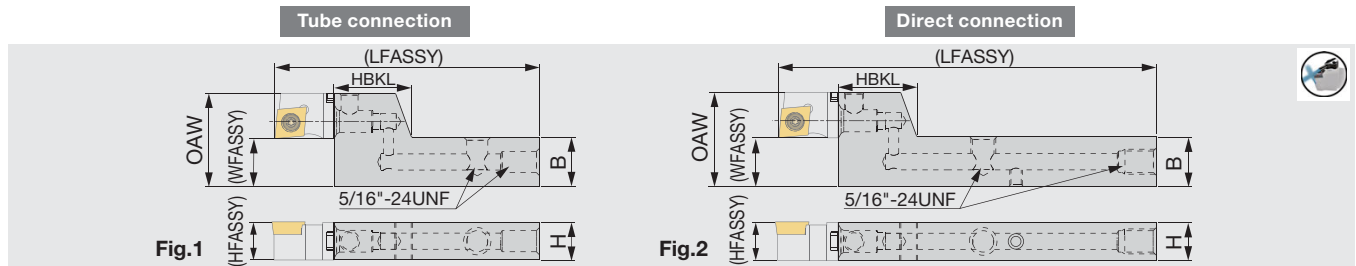

Designation	H	B	LF	OAW	WFASSY	HFASSY	LFASSY ⁽¹⁾	HBKL	Torque*	Fig.
QC-1216F-F15-CHP	12	16	65	30	15	12	85	25	3	1
QC-1216X-F15-CHP ⁽¹⁾	12	16	100	30	15	12	120	25	3	2
QC-1620X-F15-CHP	16	20	99	35	15	16	120	30	8.5	2

Torque* : Recommended clamping torque (N·m)
QC12 heads only can be mounted on these shanks.
(*) : Compatible to the direct internal coolant supply system without the use of external coolant hose.
(1) The size is true when the modular head with LH = 19,5 mm is mounted.

SPARE PARTS

Designation	Clamping screw	Wrench	Coolant plug	Wrench	DirectJet plug	Wrench
QC-1212*	SRM6X0.5-26977	P-3	-	-	-	-
QC-1212F-CHP, QC-1216F-F15-CHP	SRM6X0.5-26977	P-3	SR5/16UNF TL360	P-4	-	-
QC-1012H-CHP	SRM5X0.5	P-2.5	SR 5/16UNF TL360	P-4	SSHM4-4-TB	P-2
QC-1212X-CHP, QC-1216X-F15-CHP	SRM6X0.5-26977	P-3	SR5/16UNF TL360	P-4	SSHM4-6-TB	P-2
QC-1616X-CHP, QC-1620X-F15-CHP	SRM8X0.5	P-5	SR 5/16UNF TL360	P-4	SSHM4-6-TB	P-2

ACCESSORY

MODUMINI^{INI}TURN

QC-10/12/16D28EXC

Modular head holder for insert change

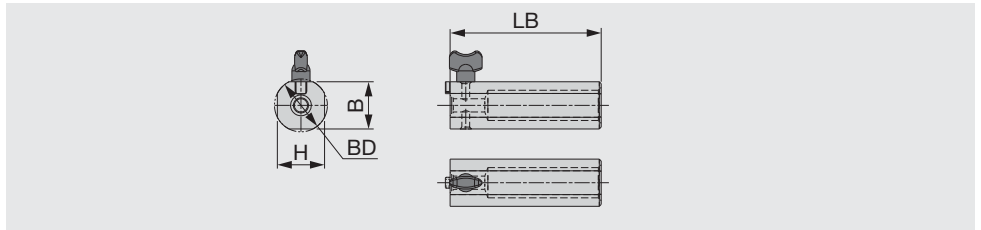

Designation	BD	LB	H	B
QC-10D28EXC	27	80	24	24
QC-12D28EXC	28	80	25	25
QC-16D28EXC	28	80	25	25

Note: This is a dedicated modular-head holder designed to facilitate insert changes. Do not use this holder for machining as it may cause damages to tool, workpiece, machine, and possible human injury.

SPARE PARTS



Designation	Fixing screw
QC-**D28EXC	KNOBM5X10

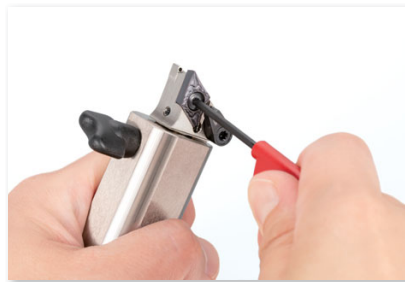

ModuMini-Turn modular heads are small. When it is difficult to change inserts while holding the modular head with fingers, use the dedicated holder to facilitate insert changes.

QC12-STOPPER

Protective plug for shank

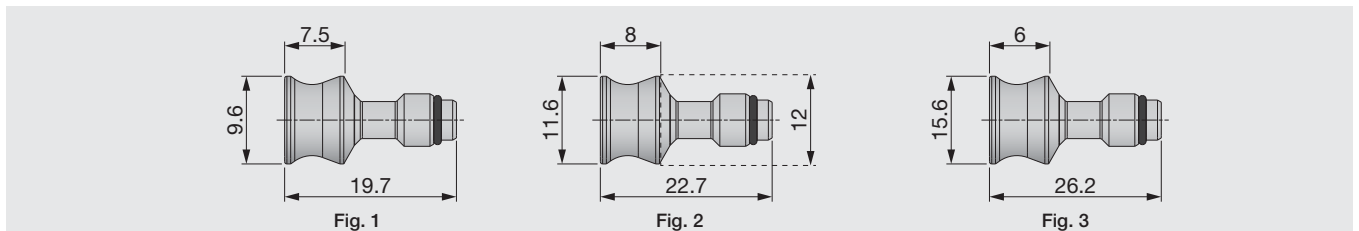

Designation	Fig.
QC10-STOPPER	1
QC12-STOPPER	2
QC16-STOPPER	3

SPARE PARTS



Designation	O-ring
QC10-STOPPER	ORSS-0353.5X1.0NBR70
QC12-STOPPER	ORSS-0454.5X1.0NBR70
QC16-STOPPER	ORSS-0757.5X1.0NBR70



The cutting head located in the feed direction of the Y-axis tool can be removed to make room for machining larger-sized barstock. If this is the case, attach the plug to the shank to protect the coupling surface from chips, as well as prevent coolant leakage during machining.

Grade

Insert

Ext. Toolholder

Int. Toolholder

Threading

Grooving

Shaper

Endmill

Drilling Tool

Technical Reference

4. Internal Toolholders





Main products

	TINY M^{INI}TURN Solid boring bar for turning small diameters with high precision 	4-34 -
	STREAMJETBAR Highly rigid toolholders providing good chip evacuation 	4-9 -
	MINI F^{ORCE}TURN Economical double-sided inserts with excellent sharpness 	WXGU 4-28 DXGU 4-29
	Y-PRO SERIES Inserts with 25° corner angle for profiling  Shank $\varnothing 12 - 16$ mm	4-19
	Mogul Bar  Anti vibration boring bar and special chipbreaker for good chip evacuation -Opposite direction to the feed-	4-13
	LBM Series Min machining diameter $\varnothing 1.0$ – with high precision	4-30 -
	STICK DUO  Economical 2 corners solid bar with wide range of choice	4-47
	Shaper DUO  Unique tools for Hexalobular, Hexagon and Square hole process.	7-13
	Sleeve  Wide range of choice -Coolant supply / Adjustable overhang length	4-44, 4-50

Miniature Internal Turning - Quick Guide

Positive type

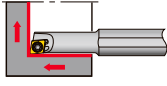
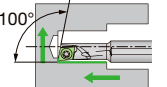
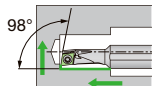
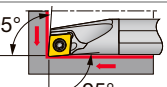
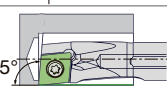
StreamJet-Bar / Mogul Bar

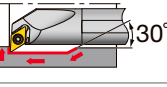
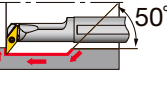
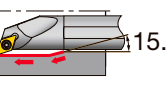
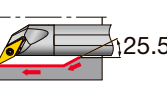
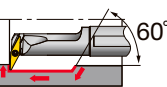
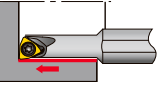
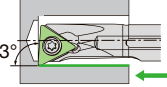
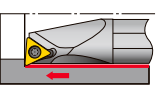
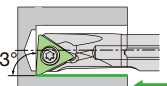
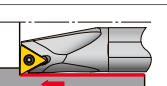
Application	Style	Designation	Insert	Material	Through coolant	StreamJet-Bar	Mogul Bar	Min. bore diameter DMIN (mm)						Page	
								0	10	20	30	40	50		
Boring & Internal facing		SEXPR	EP...	Steel Carbide	●	✓		04.5 07	04.5 07						4-43
		S/C-MBR-OH	MBL...	Steel Carbide	●		✓		05						4-10
		S/C-SEXR-OH	ERGH..	Steel Carbide	●		✓		06						4-11
		SCLCR/L	CC...	Steel Carbide	●	✓			05 027	05 027					4-12
		S/C-SCLCR-OH	CC..	Steel Carbide	●		✓		010 018						4-13
		S/C-SCLPR-OH	CP...	Steel Carbide	●		✓		07 010						4-14
Boring & internal profiling		SDUCR/L	DC...	Steel Carbide	●	✓		013 032	013 027						4-15
		SVUCR/L	VC...	Steel Carbide	●	✓		016 032	018 032						4-16
		SDQCR/L	DC...	Steel Carbide	●	✓		013 030	013 025						4-17
		SVQCR/L	VC...	Steel Carbide	●	✓		013.5 021.5	013.5 021.5						4-18
		SYUBR/L	YW...	Steel Carbide	●	✓		020	020 024.5						4-19
Boring		SWUBR/L	WB...	Steel Carbide	●	✓		06 08	06 08						4-20
		S/C-STUCR-OH	TC..	Steel Carbide	●		✓		08						4-21
		STUPR/L	TP...	Steel Carbide	●	✓		08 034	08 027						4-22
		S/C-STUPR-OH	TP..	Steel Carbide	●		✓		010 022						4-23
Blind hole boring		STFPR/L	TP...	Steel Carbide	●	✓		010 027	010 022						4-24

StreamJet-Bar / Mogul Bar

Application	Style	Designation	Insert	Material	Through coolant	StreamJet-Bar	Mogul Bar	Min. bore diameter DMIN (mm)						Page
								0	10	20	30	40	50	
Internal undercut & profiling		SYQBR/L	YW...	Steel Carbide	●	✓								4-25
Front turning, Back turning		C-STZCR-OH	TC..	Carbide	●	✓								4-25
		C-STZPR-OH	TP...	Carbide	●	✓								4-25
Back boring		SDZCR/L	DC...	Steel Carbide	●	✓								4-26
		SVZCR/L	VC...	Steel	●	✓								4-26
		SVZBR/L	VB...	Steel	●	✓								4-27
		SEZPR/L	EP...	Steel Carbide	●	✓								4-27
Internal sphere cutting		SVJCR/L	VC...	Steel	●	✓								4-28

Double-sided insert with positive cutting edges

MiniForce-Turn

Application	Style	Designation	Insert	Material	Through coolant	MINIFURN	Min. bore diameter DMIN (mm)						Page
							0	10	20	30	40	50	
Boring & internal facing		SWLXR/L	WX*U...	Steel Carbide	●	✓							4-28
Boring & internal profiling		SDXXR/L	DX*U...	Steel Carbide	●	✓							4-29
Back boring		SDZXR/L	DX*U...	Steel Carbide	●	✓							4-29

Grade

Insert

Ext. Toolholder

Int. Toolholder

Threading

Grooving

Shaper

Endmill

Drilling Tool

Technical Reference

Miniature Internal Turning - Quick Guide

Solid bar type

LBM series

Applica- tion	Style	Designation	Insert	Through coolant	ISO Insert	Min. bore diameter DMIN (mm)						Page
						0	10	20	30	40	50	
Internal, Front turning		LBMAR	LBM..		✓	0	10	20	30	40	50	4-30
		LBMAR-S	LBMD..S		✓	0	10	20	30	40	50	4-30
		CH-LBML	..LBM LBMD..S		✓	0	10	20	30	40	50	4-31
		DS-LBMBL	..LBM LBMD..S		✓	0	10	20	30	40	50	4-31

TinyMini-Turn

Solid carbide tools for small diameters turning

Application	Description	Through coolant	Cylindrical shank		Groove width (mm)	Min. bore diameter DMIN (mm)										Page
			04	07		0	2	4	6	8	10	12	14	15		
Boring, profiling & chamfering	TBT		●	●	-	0.6										4-34
	JBT	●	●	●	-	1										4-35
Internal, Face grooving	TBP		●	●	-	2.8										4-36
	JBP	●	●	●	-	2.8										4-36
Back boring & chamfering	TBU			●	-											4-36
	JBU	●		●	-											4-37
Boring & 45° chamfering	TBC			●	-											4-37
	JBC	●		●	-											4-37
Back boring	TBB		●	●	-	3										4-38
	JBB	●	●	●	-	3										4-38
Threading (Metric thread)	TBI		●	●	-											4-38
	JBI	●	●	●	-											4-39
Internal Grooving	TBG		●	●	0.5 - 2	2										4-39
	JBG	●	●	●	0.5 - 2	2										4-40
Face grooving	TBF			●	1 - 3											4-41
	JBF	●		●	1 - 3											4-41
Face grooving (for shaft)	TBS			●	2											4-42
	JBS	●		●	2											4-42
Boring & profiling (full radius type)	TBR			●	1											4-42
	JBR	●		●	1											4-42

TinyMini-Turn

Indexable tools for small diameters turning

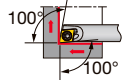
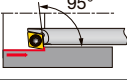
Application	Description	Material	Cylindrical shank		Min. bore diameter DMIN (mm)						Page	
			ø7	Through coolant	0	2	4	6	8	10		
Boring & internal facing 	SEXPR	Steel Carbide	●	●			ø5	ø6				4-43
Back boring 	SEZPR	Steel Carbide	●	●			ø5.5					4-43

STICK DUO series

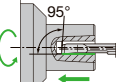
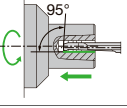
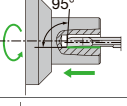
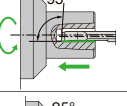
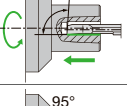
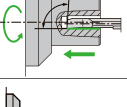
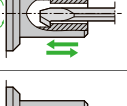
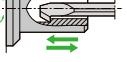
Application	Style	Designation	Sleeve	Cylindrical shank								Min. bore diameter DMIN (mm)	High precision	Page
				ø2	ø2.5	ø3	ø3.5	ø4	ø5	ø6	ø8			
Internal, Front turning		SBFS-S	HY-NBH-OH HY-NBH NBH	●	●	●	●	●	●	●		2.2 - 6.2		4-54
		SBFB-F	HY-NBH-OH HY-NBH NBH	●	●	●	●	●	●	●		2.2 - 6.2		4-55
		SBFS-H	HY-NBH-OH HY-NBH NBH	●	●	●	●	●	●	●	●	2.2 - 8.2		4-56
		SHFS-S	HY-NBH-OH HY-NBH NBH	●	●	●	●	●	●			2.2 - 5.2	●	4-57
		SHFB-F	HY-NBH-OH HY-NBH NBH	●	●	●	●	●	●			2.2 - 5.2	●	4-58
		SHFS-H	HY-NBH-OH HY-NBH NBH	●	●	●	●	●	●			2.2 - 5.2	●	4-59
Internal, Back turning		SBB-S	HY-NBH-OH HY-NBH NBH			●		●				3.0 - 4.0		4-60
		SBB	HY-NBH-OH HY-NBH NBH			●		●				3.0 - 4.0		4-60

Grade
Insert
Ext. Toolholder
Int. Toolholder
Threading
Grooving
Shaper
Endmill
Drilling Tool
Technical Reference



Miniature Internal Turning - Quick Guide

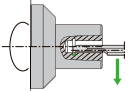
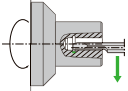
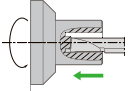

STICK DUO series

Application	Style	Designation	Sleeve	Cylindrical shank					Min. bore diameter DMIN (mm)	Groove width (mm)	Page
				ø3	ø4	ø5	ø6	ø8			
Internal, Grooving		SBG-S	HY-NBH-OH HY-NBH NBH	●	●	●	●	●	3.0 - 8.0	0.5 - 2.0	4-61
		SBG	HY-NBH-OH HY-NBH NBH	●	●	●	●	●	3.0 - 8.0	0.5 - 2.0	4-62
Internal, Face grooving		SFG	HY-NBH-OH HY-NBH NBH				●	●	6.0 - 8.0	1.0 - 3.0	4-63

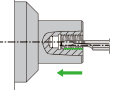
STICK DUO series

Application	Style	Designation	Sleeve	Cylindrical shank						Min. bore diameter DMIN (mm)	Pitch (mm)						Page	
				ø2.5	ø3	ø3.5	ø4	ø5	ø6		0	1	2	3	4	5		
Internal, Threading		SBT	HY-NBH-OH HY-NBH NBH	●	●	●	●	●	●	2.5 - 6.0	0.5	1.75						4-64

SHAPER DUO

Application	Style	Designation	Sleeve	Cylindrical shank								Socket size	AF range (mm)	Page
				ø2	ø2.5	ø3	ø3.5	ø4	ø5	ø6	ø8			
Hexagon		SSP-H	HY-NBH-OH HY-NBH NBH	●		●		●	●	●	●	-	1.0 - 12.1	7-3
Hexalobular		SSP-T	HY-NBH-OH HY-NBH NBH							●		T6 - T30	-	7-4
Square		SSP-S	HY-NBH-OH HY-NBH NBH	●	●	●	●	●	●	●	●	-	2.0 - 8.0	7-5

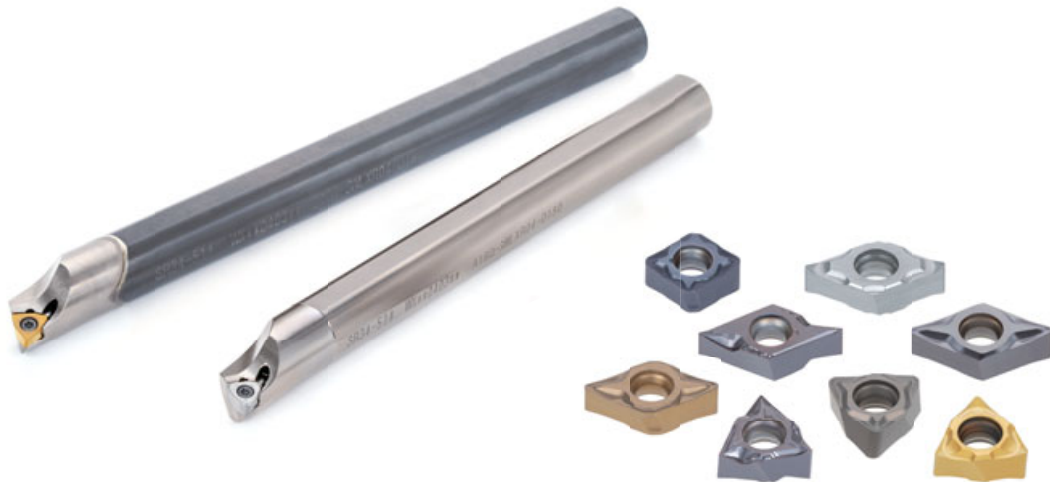

Economical double-sided positive insert

Innovative geometry and seat interface ensures stability and high performance.

Insert

CXMU0603... 4 edges, rhombic 80°

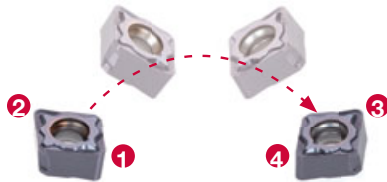

DXM/GU0703... 4 edges, rhombic 55°

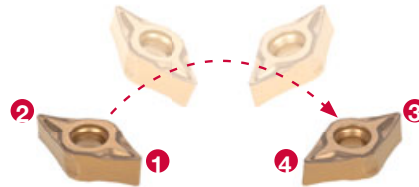

WXGU0403... 6 positive cutting edges

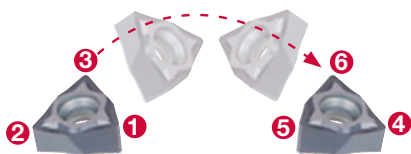

Low cutting force machining with high rake angle



MINIFORCE
A12M-SCLXR06-D140

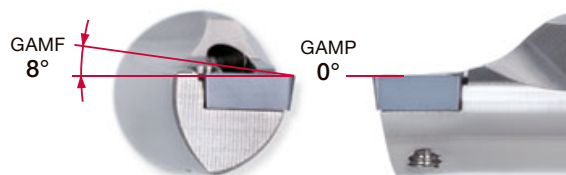

Conventional
A12M-SCLCR06-D140

Mogul Bar

For ID boring | Swiss CNC Lathes



Highly rigid bars and inserts that direct chips away from the part

Unique boring bar design greatly improves rigidity combined with chipbreakers that control the direction of the chip evacuation during the boring operation

Features

Toolholder overhang

Steel shank $L/D \leq 5$

Carbide shank $L/D \leq 7$

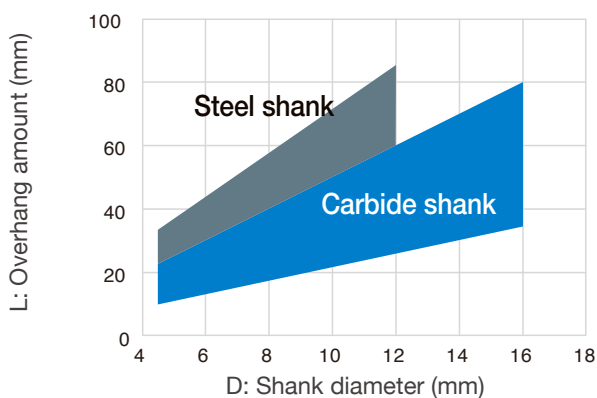

Cutting conditions
 Material : Alloy steel, Stainless steel
 $V_c = 80\text{m/min}$ $f = 0.05 - 0.1 \text{ mm/rev}$
 $a_p = 0.1 - 0.5 \text{ mm}$
 WET

Features

F1, F05, FG chipbreakers developed for blind hole applications to direct chips backward and out of the hole to prevent chip packing

Coolant through boring bars to support chip evacuation

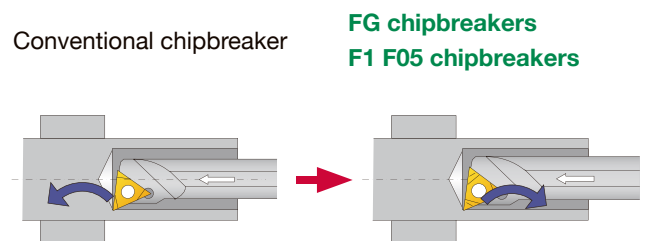

Reference pages: Inserts → [2-11](#), CBN → [2-87 -](#), PCD → [2-119 -](#),
 Shank → [4-13](#)

EP



**Rhombic, 75°
with hole
Positive 11°**

STREAMJETBAR

A/E-SEXPR/L

Screw-on boring bar, for positive 75° rhombic inserts

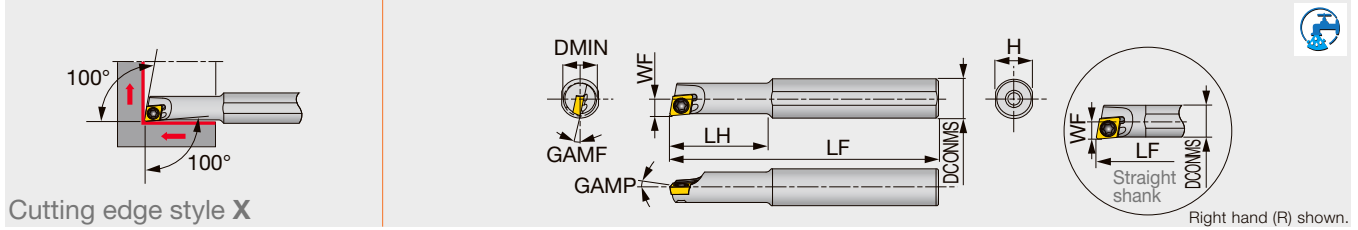

Cutting edge style X

Designation	Material	DMIN	DCONMS	WF	LF	LH	H	GAMP	GAMF	RE**	Insert	Torque*
A04F-SEXPR/L03-D045	Steel	4.5	4	2.3	80	8	3.8	0°	-15°	0.2	EP**03X1...	0.6
A04F-SEXPR/L03-D050	Steel	5	4	2.5	80	8	3.8	0°	-13°	0.2	EP**03X1...	0.6
A05F-SEXPR/L04-D055	Steel	5.5	5	2.75	80	9	4.8	0°	-12°	0.4	EP**0401...	0.6
A06G-SEXPR/L04-D070	Steel	7	6	3.6	90	11	5.75	0°	-12°	0.4	EP**0401...	0.6
A08H-SEXPR/L04-D055	Steel	5.5	8	2.75	100	16	7.5	0°	-12°	0.4	EP**0401...	0.6
A08H-SEXPR/L04-D070	Steel	7	8	3.6	100	20	7.5	0°	-12°	0.4	EP**0401...	0.6
E04G-SEXPR/L03-D045	Carbide	4.5	4	2.3	90	9	3.8	0°	-15°	0.2	EP**03X1...	0.6
E04G-SEXPR/L03-D050	Carbide	5	4	2.5	90	9	3.8	0°	-13°	0.2	EP**03X1...	0.6
E05G-SEXPR/L04-D055	Carbide	5.5	5	2.75	90	10	4.8	0°	-12°	0.4	EP**0401...	0.6
E06H-SEXPR/L04-D070	Carbide	7	6	3.6	100	12	5.75	0°	-12°	0.4	EP**0401...	0.6
E08K-SEXPR/L04-D055	Carbide	5.5	8	2.75	125	28	7.5	0°	-12°	0.4	EP**0401...	0.6
E08K-SEXPR/L04-D070	Carbide	7	8	3.6	125	40	7.5	0°	-12°	0.4	EP**0401...	0.6

*Torque: Recommended clamping torque (N·m)

**RE : Standard corner radius

Note: Use right-hand toolholders (SEXPR**) with left-hand inserts (L); and left-hand toolholders (SEXPL**) with right-hand inserts (R).

SPARE PARTS



Designation	Clamping screw	Wrench
A**-SEXPR/L03-D...	CSTA-1.6	T-6F
A**-SEXPR/L04-D...	CSTB-2	T-6F
E**-SEXPR/L03-D...	CSTA-1.6	T-6F
E**-SEXPR/L04-D...	CSTB-2	T-6F

Reference pages: Insert → 2-34 -, CBN → 2-93, PCD → 2-122

Grade

Insert

Ext. Toolholder

Int. Toolholder

Threading

Grooving

Shaper

Endmill

Drilling Tool

Technical Reference

MB



**Rhombic, 75°
with hole
Positive 9°**

S/C-MBR-OH

Screw-on boring bar, for positive 75° rhombic inserts

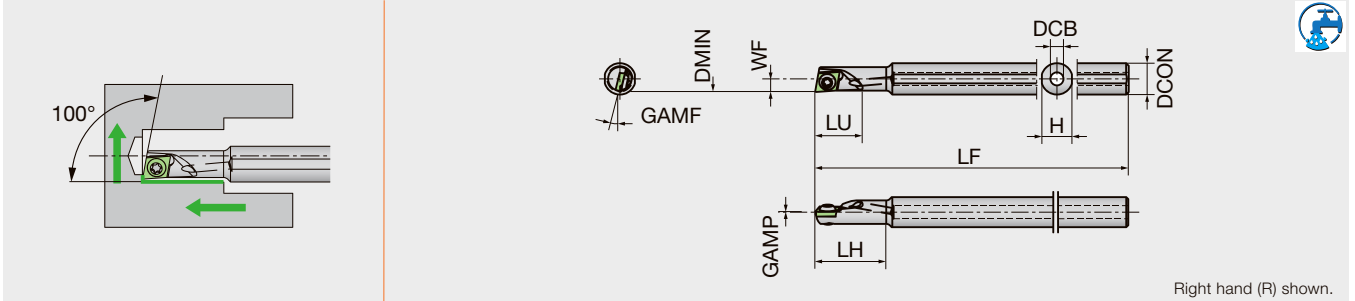

Designation	Material	DMIN	DCON	WF	LF	LH	H	GAMP	GAMF	RE*	DCB	LU	Insert
S06F-MBRD05-OH	Steel	5	6	2.5	80	13.5	5.7	0°	13°	0.15	2.5	9	MBL..
C045F-MBRD05-OH	Carbide	5	4.5	2.5	80	10.5	4	0°	13°	0.15	1.5	9	MBL..
C06F-MBRD05-OH	Carbide	5	6	2.5	80	18	5.7	0°	13°	0.15	1.5	9	MBL..

Use a left-handed insert
For F1 chipbreaker, right-hand inserts fit to right-hand toolholder
F1 chipbreaker evacuates chips BACKWARD**RE: Standard corner radius
*RE: Standard corner radius

SPARE PARTS



Designation	Clamp screw	Wrench (for Clamp screw)
**-MBRD05-OH	LR-S-2*3.5	CLR-13S

INSERT

MBL with chipbreaker

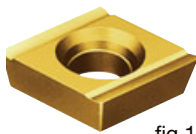
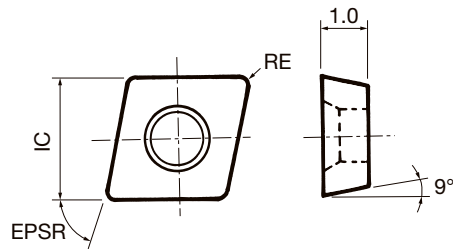

fig.1



fig.2



	P	M	N	S	H
Steel	★	☆	☆		
Stainless	☆	★	☆	☆	
Non-ferrous			★	☆	
Superalloys	☆				
Hard materials	★				

★ : First choice
☆ : Second choice

Designation	HAND	Coated				RE	EPSR	IC	Figure
		QM3	ST4	TM4	ZM3				
MBL005FL	L	●		●	●	0.05	75°	3.6	1
MBL015FL	L	●		●	●	0.15	75°	3.6	1
MBL005FRF1	R	●	●	●		0.05	75°	3.6	2
MBL015FRF1	R	●	●	●		0.15	75°	3.6	2

● : Line up



**Rhombic, 75°
with hole
Positive 9°**

S/C-SEXR-OH

Screw-on boring bar, for positive 75° rhombic inserts

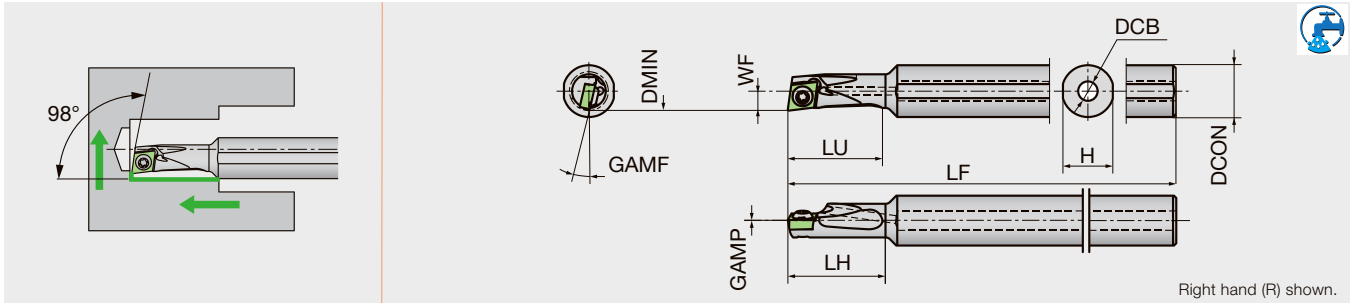

Designation	Material	DMIN	DCON	WF	LF	LH	H	GAMP	GAMF	RE*	DCB	LU	Insert
S08G-SEXRRT3D06-OH	Steel	6	8	3	90	15	7.7	0°	13°	0.2	3	15	ERGHT301..
C05G-SEXRRT3D06-OH	Carbide	6	5	3	90	12.5	4	0°	13°	0.2	1.5	11	ERGHT301..
C06G-SEXRRT3D06-OH	Carbide	6	6	3	90	20	5.7	0°	13°	0.2	1.5	11	ERGHT301..
C06G-SEXRLT3D06-OH	Carbide	6	6	3	90	20	5.7	0°	13°	0.2	1.5	11	ERGHT301..

Use a left-handed insert
For F1 chipbreaker, right-hand inserts fit to right-hand toolholder
F1 chipbreaker evacuates chips BACKWARD
*RE: Standard corner radius

SPARE PARTS



Designation	Clamp screw	Wrench (for Clamp screw)
**-SEXRRT3D06-OH	LR-S-2*3.7	CLR-13S

INSERT

ERGH

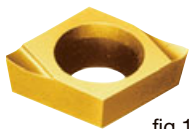

fig.1

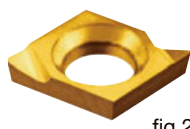
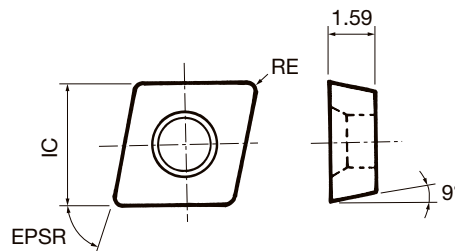

fig.2



	P	M	N	S	H
Steel	★	☆	☆	☆	☆
Stainless	☆	★	☆	☆	☆
Non-ferrous	☆	☆	★	☆	☆
Superalloys	☆	☆	☆	★	☆
Hard materials	★	☆	☆	☆	☆

★ : First choice
☆ : Second choice

Designation	HAND	Coated				RE	EPSR	IC	Figure
		QM3	ST4	TM4	ZM3				
ERGHT30102FRA2	R			●	●	0.2	75°	3.97	1
ERGHT30104FRA2	R			●	●	0.4	75°	3.97	1
ERGHT30102FLA2	L			●	●	0.2	75°	3.97	1
ERGHT30104FLA2	L			●	●	0.4	75°	3.97	1
ERGHT30101FRF1	R	●	●	●		0.1	75°	3.97	2
ERGHT30102FRF1	R	●	●	●		0.2	75°	3.97	2
ERGHT30104FRF1	R	●	●	●		0.4	75°	3.97	2

● : Line up

CC



**Rhombic, 80°
with hole
Positive 7°**

STREAMJETBAR

A/E-SCLCR/L

Screw-on boring bar, for positive 80° rhombic inserts

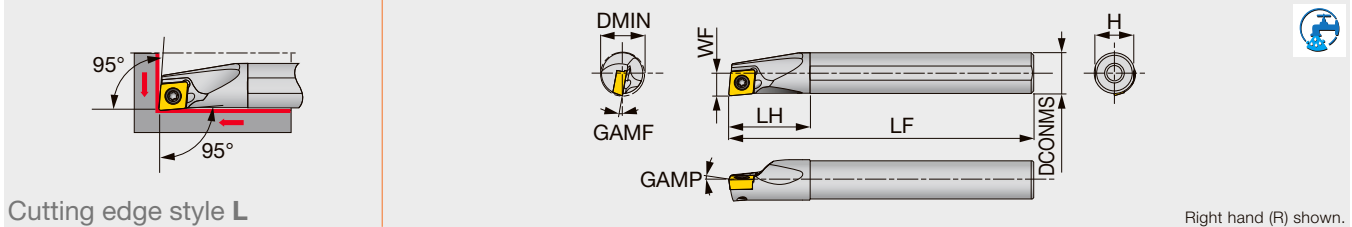

Cutting edge style L

Right hand (R) shown.

Designation	Material	DMIN	DCONMS	WF	LF	LH	H	GAMP	GAMF	RE**	Insert	Torque*
A04F-SCLCR/L03-D050	Steel	5	4	2.5	80	8	3.8	0°	-15°	0.2	CC**03X1...	0.6
A05F-SCLCR/L03-D060	Steel	6	5	3	80	9	4.8	0°	-13°	0.2	CC**03X1...	0.6
A06G-SCLCR/L04-D070	Steel	7	6	3.5	90	11	5.75	0°	-13°	0.2	CC**04T1...	0.6
A07G-SCLCR/L04-D080	Steel	8	7	4	90	12	6.75	0°	-11°	0.2	CC**04T1...	0.6
A08H-SCLCR/L06-D100	Steel	10	8	5.5	100	16	7.5	0°	-13°	0.4	CC**0602...	1.2
A10F-SCLCR06-D120	Steel	12	10	6	80	20	9	0°	-10°	0.4	CC**0602...	1.2
A10K-SCLCR/L06-D120	Steel	12	10	6	125	20	9	0°	-10°	0.4	CC**0602...	1.2
A12H-SCLCR06-D140	Steel	14	12	7	100	24	11	0°	-8°	0.4	CC**0602...	1.2
A12M-SCLCR/L06-D140	Steel	14	12	7	150	24	11	0°	-8°	0.4	CC**0602...	1.2
A12H-SCLCR06-D160	Steel	16	12	9	100	24	11	0°	-7°	0.4	CC**0602...	1.2
A12M-SCLCR/L06-D160	Steel	16	12	9	150	24	11	0°	-7°	0.4	CC**0602...	1.2
A16K-SCLCR09-D180	Steel	18	16	9	125	32	15	0°	-9°	0.8	CC**09T3...	3
A16Q-SCLCR/L09-D180	Steel	18	16	9	180	32	15	0°	-10°	0.8	CC**09T3...	3
A16K-SCLCR09-D200	Steel	20	16	11	125	32	15	0°	-9°	0.8	CC**09T3...	3
A16Q-SCLCR/L09-D200	Steel	20	16	11	180	32	15	0°	-9°	0.8	CC**09T3...	3
A20R-SCLCR/L09-D220	Steel	22	20	11	200	32	18	0°	-8°	0.8	CC**09T3...	3
A25S-SCLCR/L09-D270	Steel	27	25	13.5	250	45	23	0°	-6°	0.8	CC**09T3...	3
E04G-SCLCR/L03-D050	Carbide	5	4	2.5	90	9	3.8	0°	-15°	0.2	CC**03X1...	0.6
E05G-SCLCR/L03-D060	Carbide	6	5	3	90	10	4.8	0°	-13°	0.2	CC**03X1...	0.6
E06H-SCLCR/L04-D070	Carbide	7	6	3.5	100	12	5.75	0°	-13°	0.2	CC**04T1...	0.6
E07H-SCLCR/L04-D080	Carbide	8	7	4	100	14	6.75	0°	-11°	0.2	CC**04T1...	0.6
E08G-SCLCR06-D100	Carbide	10	8	5.5	90	22	7.5	0°	-13°	0.4	CC**0602...	1.2
E08K-SCLCR/L06-D100	Carbide	10	8	5.5	125	22	7.5	0°	-13°	0.4	CC**0602...	1.2
E10F-SCLCR06-D120	Carbide	12	10	6	80	25	9	0°	-10°	0.4	CC**0602...	1.2
E10H-SCLCR06-D120	Carbide	12	10	6	100	25	9	0°	-10°	0.4	CC**0602...	1.2
E10M-SCLCR/L06-D120	Carbide	12	10	6	150	25	9	0°	-10°	0.4	CC**0602...	1.2
E12G-SCLCR06-D140	Carbide	14	12	7	90	27	11	0°	-8°	0.4	CC**0602...	1.2
E12J-SCLCR06-D140	Carbide	14	12	7	110	27	11	0°	-8°	0.4	CC**0602...	1.2
E12Q-SCLCR/L06-D140	Carbide	14	12	7	180	27	11	0°	-8°	0.4	CC**0602...	1.2
E12G-SCLCR06-D160	Carbide	16	12	9	90	27	11	0°	-7°	0.4	CC**0602...	1.2
E12J-SCLCR06-D160	Carbide	16	12	9	110	27	11	0°	-7°	0.4	CC**0602...	1.2
E12Q-SCLCR/L06-D160	Carbide	16	12	9	180	27	11	0°	-7°	0.4	CC**0602...	1.2
E16H-SCLCR09-D180	Carbide	18	16	9	100	32	15	0°	-10°	0.8	CC**09T3...	3
E16L-SCLCR09-D180	Carbide	18	16	9	130	32	15	0°	-10°	0.8	CC**09T3...	3
E16R-SCLCR/L09-D180	Carbide	18	16	9	200	32	15	0°	-10°	0.8	CC**09T3...	3
E16H-SCLCR09-D200	Carbide	20	16	11	100	32	15	0°	-9°	0.8	CC**09T3...	3
E16L-SCLCR09-D200	Carbide	20	16	11	130	32	15	0°	-9°	0.8	CC**09T3...	3
E16R-SCLCR/L09-D200	Carbide	20	16	11	200	32	15	0°	-9°	0.8	CC**09T3...	3
E20S-SCLCR09-D220	Carbide	22	20	11	250	36	18	0°	-8°	0.8	CC**09T3...	3
E25T-SCLCR09-D270	Carbide	27	25	13.5	300	45	23	0°	-6°	0.8	CC**09T3...	3

*Torque: Recommended clamping torque (N-m)

**RE: Standard corner radius

Note: Use right-hand toolholders (SCLCR**) with left-hand inserts (L); and left-hand toolholders (SCLCL**) with right-hand inserts (R).

SPARE PARTS



Designation	Clamping screw	Wrench
A**-SCLCR/L03-D-..., E**-SCLCR/L03-D-...	CSTA-1.6	T-6F
A**-SCLCR/L04-D-..., E**-SCLCR/L04-D-...	CSTB-2	T-6F
A**-SCLCR/L06-D-..., E**-SCLCR/L06-D-...	CSTB-2.5S	T-8F
A**-SCLCR/L09-D-..., E2**-SCLCR/L09-D-...	CSTB-4S	T-15F
E16*-SCLCR/L09-D-...	CSTB-4L060	T-15F

Reference pages: Insert → 2-11 -, CBN → 2-87 -, PCD → 2-119 -

Mogul Bar

S/C-SCLC-OH

Screw-on boring bar, for positive 80° rhombic inserts

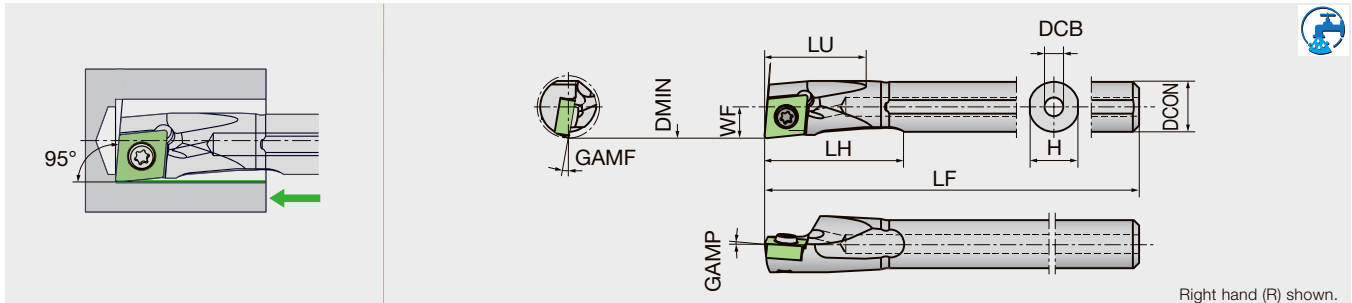

Designation	Material	DMIN	DCON	WF	LF	LH	H	GAMF	GAMP	RE*	DCB	LU	Insert
S08H-SCLCR06D10-OH	Steel	10	8	5	100	22	7.7	13°	0°	0.4	3	16	CC..0602..
S10K-SCLCR06D12-OH	Steel	12	10	6	125	27.5	9.6	11°	0°	0.4	3.5	20	CC..0602..
S12M-SCLCR06D14-OH	Steel	14	12	7	150	32.5	11.5	9°	0°	0.4	4	23	CC..0602..
S16Q-SCLCR09D18-OH	Steel	18	16	9	180	42.5	15.4	10°	0°	0.4	5	30	CC..09T3..
C08K-SCLCR06D10-OH	Carbide	10	8	5	125	16.5	7.7	13°	0°	0.4	2.5	15	CC..0602..
C10M-SCLCR06D12-OH	Carbide	12	10	6	150	20	9.6	11°	0°	0.4	2.5	19.5	CC..0602..
C10M-SCLCL06D12-OH	Carbide	12	10	6	150	20	9.6	11°	0°	0.4	2.5	19.5	CC..0602..
C12M-SCLCR06D14-OH	Carbide	14	12	7	150	23.5	11.5	9°	0°	0.4	3	22.5	CC..0602..

Use a left-handed insert

For F1 chipbreaker, right-hand inserts fit to right-hand toolholder

F1 chipbreaker evacuates chips BACKWARD

*RE: Standard corner radius

SPARE PARTS



Designation	Clamp screw	Wrench (for Clamp screw)
S/C**-SCLCR06**	LRIS-2.5*5	CLR-15S
S**-SCLCR09**	LRIS-4*8	LLR-25S-20*65

CP



**Rhombic, 80°
with hole
Positive 11°**

S/C-SCLP-OH

Screw-on boring bar, for positive 80° rhombic inserts

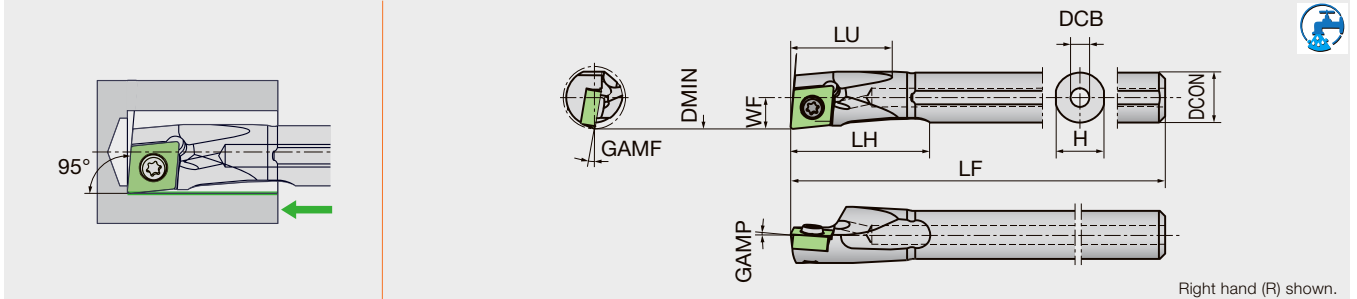

Right hand (R) shown.

Designation	Material	DMIN	DCON	WF	LF	LH	H	GAMP	GAMF	RE*	DCB	LU	Insert
S06F-SCLPR04D07-OH	Steel	7	6	3.5	80	17	5.75	5°	9°	0.2	2.5	12	CP..0401..
S07G-SCLPR04D08-OH	Steel	8	7	4	90	19.5	6.75	5°	7°	0.2	3	13.5	CP..0401..
S08H-SCLPR06D10-OH	Steel	10	8	5	100	22	7.7	5°	10°	0.4	3	16	CP..0602..
C06H-SCLPR04D07-OH	Carbide	7	6	3.5	100	11.5	5.75	5°	9°	0.2	2	12	CP..0401..
C06H-SCLPL04D07-OH	Carbide	7	6	3.5	100	11.5	5.75	5°	9°	0.2	2	12	CP..0401..
C07J-SCLPR04D08-OH	Carbide	8	7	4	110	13	6.75	5°	7°	0.2	2	13.5	CP..0401..
C08K-SCLPR06D10-OH	Carbide	10	8	5	125	16.5	7.7	5°	10°	0.4	2.5	15	CP..0602..
C08K-SCLPL06D10-OH	Carbide	10	8	5	125	16.5	7.7	5°	10°	0.4	2.5	15	CP..0602..

Use a left-handed insert
 For F1 chipbreaker, right-hand inserts fit to right-hand toolholder
 F1 chipbreaker evacuates chips BACKWARD
 *RE: Standard corner radius

SPARE PARTS



Designation	Clamp screw	Wrench (for Clamp screw)
S/C**-SCLPR04**	LR-S-2*3.7	CLR-13S
S/C**-SCLPR06**	LR-S-2.5*6	CLR-15S

Reference pages: Insert → 2-20 -, CBN → 2-90, PCD → 2-120

DC



**Rhombic, 55°
with hole
Positive 7°**

STREAMJET BAR A/E-SDUCR/L

Screw-on boring bar, for positive 55° rhombic inserts

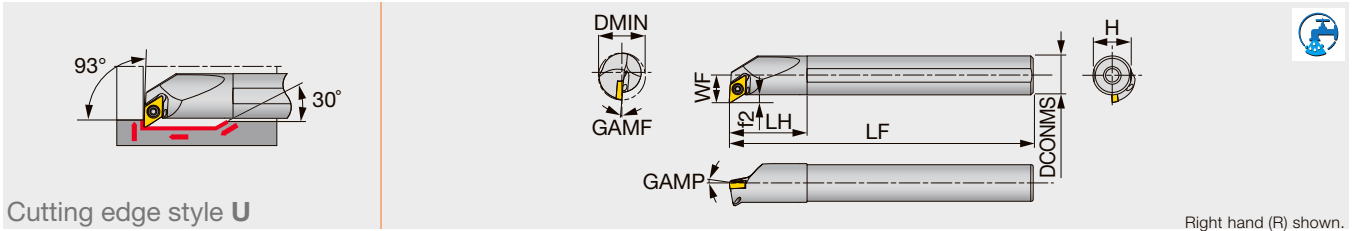

Cutting edge style U

Right hand (R) shown.

Designation	Material	DMIN	DCONMS	WF	LF	LH	H	f2	GAMP	GAMF	RE**	Insert	Torque*
A10K-SDUCR/L07-D130	Steel	13	10	7	125	20	9	2	0°	-10°	0.4	DC**0702...	1.2
A12M-SDUCR/L07-D160	Steel	16	12	9.3	150	24	11	3.3	0°	-6°	0.4	DC**0702...	1.2
A16Q-SDUCR/L07-D200	Steel	20	16	11.3	180	32	15	3.3	0°	-5°	0.4	DC**0702...	1.2
A20R-SDUCR/L11-D270	Steel	27	20	16.1	200	36	18	6.1	0°	-5°	0.8	DC**11T3...	3
A25S-SDUCR/L11-D320	Steel	32	25	18.6	250	45	23	6.1	0°	-4°	0.8	DC**11T3...	3
E10H-SDUCR07-D130	Carbide	13	10	7	100	25	9	1.9	5°	-3.5°	0.4	DC**0702...	1.2
E10M-SDUCR/L07-D130	Carbide	13	10	7	150	25	9	2	0°	-10°	0.4	DC**0702...	1.2
E12J-SDUCR07-D160	Carbide	16	12	9.3	110	27	11	3.2	0°	-6°	0.4	DC**0702...	1.2
E12Q-SDUCR/L07-D160	Carbide	16	12	9.3	180	27	11	3.3	0°	-6°	0.4	DC**0702...	1.2
E16L-SDUCR07-D200	Carbide	20	16	11.3	130	32	15	3.2	0°	-5°	0.4	DC**0702...	1.2
E16R-SDUCR/L07-D200	Carbide	20	16	11.3	200	32	15	3.3	0°	-5°	0.4	DC**0702...	1.2
E20S-SDUCR11-D270	Carbide	27	20	16.1	250	36	18	6.1	0°	-5°	0.8	DC**11T3...	3

*Torque: Recommended clamping torque (N·m)

**RE: Standard corner radius

Note: Use right-hand toolholders (SDUCR**) with left-hand inserts (L); and left-hand toolholders (SDUCL**) with right-hand inserts (R).

SPARE PARTS



Designation	Clamping screw	Wrench
A1**-SDUCR/L07-D1*0	CSTB-2.5S	T-8F
E1**-SDUCR/L07-D1*0		
A16Q-SDUCR/L07-D200	CSTB-2.5	T-8F
E16*-SDUCR/L07-D200		
A2**-SDUCR/L11-D**0	CSTB-4S	T-15F
E20S-SDUCR11-D270		

Reference pages: Insert → 2-23 -, CBN → 2-91 -, PCD → 2-120 -

Grade

Insert

Ext. Toolholder

Int. Toolholder

Threading

Grooving

Shaper

Endmill

Drilling Tool

Technical Reference

VC

Rhombic, 35°
with hole
Positive 7°



STREAMJET BAR

A/E-SVUCR/L

Screw-on boring bar, for positive 35° rhombic inserts

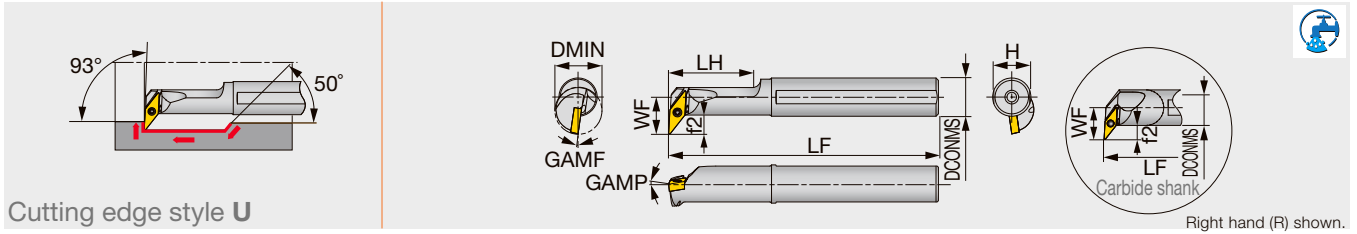

Cutting edge style U

Right hand (R) shown.

Designation	Material	DMIN	DCONMS	WF	LF	LH	H	f2	GAMP	GAMF	RE**	Insert	Torque*
A12M-SVUCR/L08-D160	Steel	16	12	11	150	30	11	5.5	0°	-8°	0.4	VC**0802...	0.6
A25S-SVUCR/L16-D320	Steel	32	25	19	250	45	23	6.5	0°	-5°	0.8	VC**1604...	3
E12Q-SVUCR/L08-D180	Carbide	18	12	11.5	180	-	11	5.5	0°	-8°	0.4	VC**0802...	0.6
E25T-SVUCR/L16-D320	Carbide	32	25	19	300	-	23	6.5	0°	-5°	0.8	VC**1604...	3

*Torque: Recommended clamping torque (N-m)

**RE : Standard corner radius

Note: Use right-hand toolholders (SVUCR**) with left-hand inserts (L); and left-hand toolholders (SVUCL**) with right-hand inserts (R).

SPARE PARTS



Designation	Clamping screw	Wrench
A12M-SVUCR/L08-D160 E12Q-SVUCR/L08-D180	CSTB-2L	T-6F
A25S-SVUCR/L16-D320 E25T-SVUCR/L16-D320	CSTB-3.5	T-15F

Reference pages: Insert → [2-50 -](#), CBN → [2-101](#), PCD → [2-127](#)

DC

Rhombic, 55°



with hole
Positive 7°

STREAMJETBAR

A/E-SDQCR/L

Screw-on boring bar, for positive 55° rhombic inserts

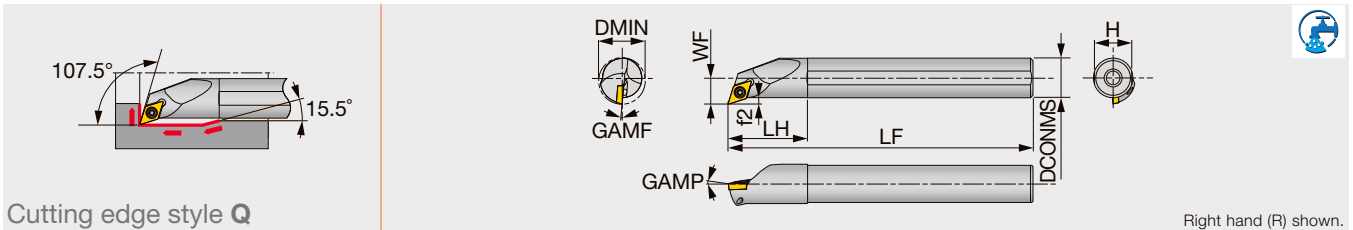

Designation	Material	DMIN	DCONMS	WF	LF	LH	H	f2	GAMP	GAMF	RE**	Insert	Torque*
A10K-SDQCR/L07-D130	Steel	13	10	7.6	125	20	9	2.6	0°	-8°	0.4	DC**0702...	1.2
A12M-SDQCR/L07-D160	Steel	16	12	8.6	150	24	11	2.6	0°	-6°	0.4	DC**0702...	1.2
A16Q-SDQCR/L07-D200	Steel	20	16	10.6	180	32	15	2.6	0°	-5°	0.4	DC**0702...	1.2
A20R-SDQCR/L11-D250	Steel	25	20	13.7	200	36	18	3.7	0°	-7°	0.8	DC**11T3...	3
A25S-SDQCR/L11-D300	Steel	30	25	16.2	250	45	23	3.7	0°	-4°	0.8	DC**11T3...	3
E10H-SDQCR07-D130	Carbide	13	10	7.6	100	25	9	2.5	0°	-8°	0.4	DC**0702...	1.2
E10M-SDQCR/L07-D130	Carbide	13	10	7.6	150	25	9	2.6	0°	-8°	0.4	DC**0702...	1.2
E12J-SDQCR07-D160	Carbide	16	12	8.6	110	27	11	2.5	0°	-6°	0.4	DC**0702...	1.2
E12Q-SDQCR/L07-D160	Carbide	16	12	8.6	180	27	11	2.6	0°	-6°	0.4	DC**0702...	1.2
E16L-SDQCR07-D200	Carbide	20	16	10.6	130	32	15	2.5	0°	-5°	0.4	DC**0702...	1.2
E16R-SDQCR/L07-D200	Carbide	20	16	10.6	200	32	15	2.6	0°	-5°	0.4	DC**0702...	1.2
E20S-SDQCR/L11-D250	Carbide	25	20	13.7	250	36	18	3.7	0°	-7°	0.8	DC**11T3...	3

*Torque: Recommended clamping torque (N·m)

**RE : Standard corner radius

Note: Use right-hand toolholders (SDQCR**) with left-hand inserts (L); and left-hand toolholders (SDQCL**) with right-hand inserts (R).

SPARE PARTS



Designation	Clamping screw	Wrench
A1**-SDQCR/L07-D**0	CSTB-2.5S	T-8F
A2**-SDQCR/L11-D**0		
A2**-SDQCR/L11-D**0	CSTB-4S	T-15F
E20S-SDQCR/L11-D250		

Reference pages: Insert → 2-50 -, CBN → 2-101, PCD → 2-127

Grade

Insert

Ext. Toolholder

Int. Toolholder

Threading

Grooving

Shaper

Endmill

Drilling Tool

Technical Reference

VC

Rhombic, 35°
with hole
Positive 7°



STREAMJETBAR

A/E-SVQCR/L

Screw-on boring bar, for positive 35° rhombic inserts

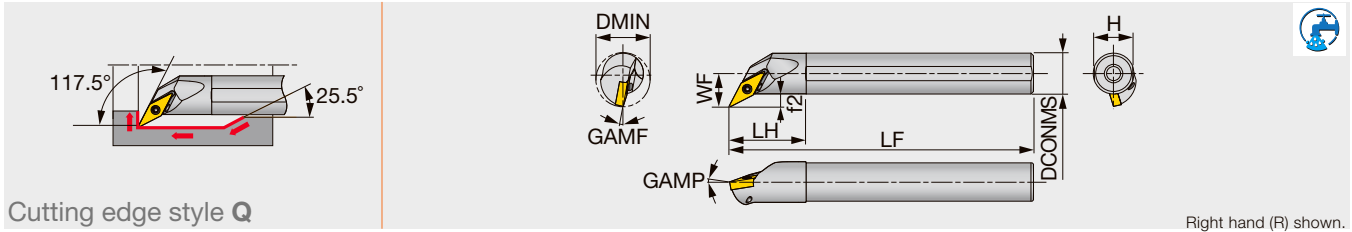

Right hand (R) shown.

Designation	Material	DMIN	DCONMS	WF	LF	LH	H	f2	GAMP	GAMF	RE**	Insert	Torque*
A10K-SVQCR/L08-D135	Steel	13.5	10	8	125	20	9	3	-5°	-8°	0.4	VC**0802...	0.6
A16Q-SVQCR/L11-D215	Steel	21.5	16	13	180	30	15	4.9	-5°	-8°	0.4	VC**1103...	1.2
E10M-SVQCR/L08-D135	Carbide	13.5	10	8	150	25	9	3	-5°	-8°	0.4	VC**0802...	0.6
E16R-SVQCR/L11-D215	Carbide	21.5	16	13	200	32	15	4.9	-5°	-8°	0.4	VC**1103...	1.2

*Torque: Recommended clamping torque (N-m)

**RE : Standard corner radius

Note: Use right-hand toolholders (SVQCR**) with left-hand inserts (L); and left-hand toolholders (SVQCL**) with right-hand inserts (R).

SPARE PARTS



Designation	Clamping screw	Wrench
A10K-SVQCR/L08-D135	CSTB-2L	T-6F
E10M-SVQCR/L08-D135	CSTB-2.5	T-8F
A16Q-SVQCR/L11-D215	CSTB-2.5	T-8F
E16R-SVQCR/L11-D215	CSTB-2.5	T-8F

Reference pages: Insert → [2-50 -](#), CBN → [2-101](#), PCD → [2-127](#)

YW



Rhombic, 25°
with hole
Positive 7°

Y-PRO SERIES

A/E-SYUBR/L

Screw-on boring bar, for positive 25° rhombic inserts

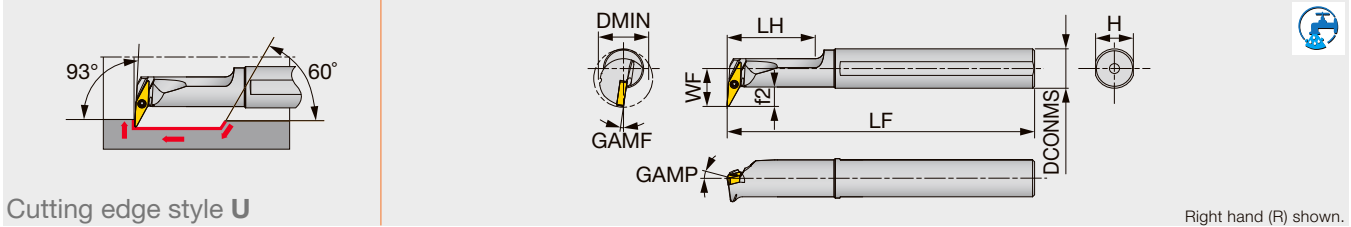

Cutting edge style U

Right hand (R) shown.

Designation	Material	DMIN	DCONMS	WF	LF	LH	H	f2	GAMP	GAMF	RE**	Insert	Torque*
A16Q-SYUBR/L11-D200	Steel	20	16	15.5	180	35	15	8	0°	-8°	0.4	YW**11T2...	0.6
E12Q-SYUBR/L11-D200	Carbide	20	12	13.5	180	27	11	7.5	0°	-8°	0.4	YW**11T2...	0.6
E16R-SYUBR/L11-D245	Carbide	24.5	16	16	200	32	15	8	0°	-8°	0.4	YW**11T2...	0.6

*Torque: Recommended clamping torque (N-m)

**RE : Standard corner radius

SPARE PARTS



Designation	Clamping screw	Wrench
A16Q-SYUBR/L11-D200	CSTB-2L	T-6F
E**-SYUBR/L11-D...	CSTB-2L	T-6F

Reference pages: Insert → [2-59](#)

Grade

Insert

Ext. Toolholder

Int. Toolholder

Threading

Grooving

Shaper

Endmill

Drilling Tool

Technical Reference

WB



Trigon, 80°
with hole
Positive 5°

STREAMJETBAR

A/E-SWUBR/L

Screw-on boring bar, for positive 80° trigon inserts

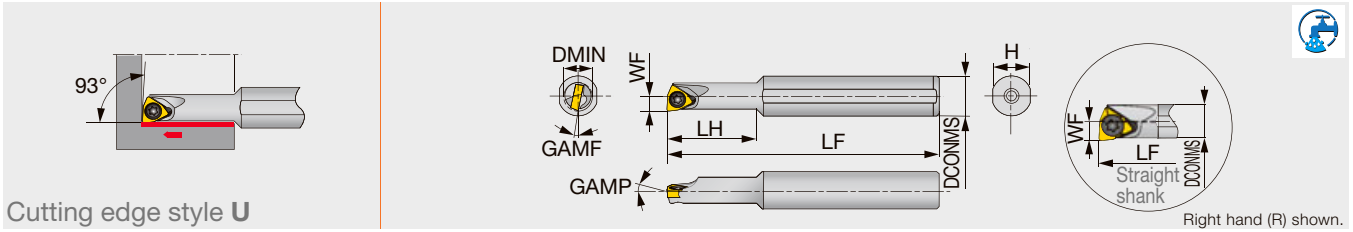

Cutting edge style U

Right hand (R) shown.

Designation	Material	DMIN	DCONMS	WF	LF	LH	H	GAMP	GAMF	RE**	Insert	Torque*
A05F-SWUBR/L03-D060	Steel	6	5	3	80	9	4.8	0°	-13°	0.4	WB**0301...	0.6
A06G-SWUBR/L03-D070	Steel	7	6	3.5	90	11	5.75	0°	-12°	0.4	WB**0301...	0.6
A07G-SWUBR/L03-D080	Steel	8	7	4	90	12	6.75	0°	-11°	0.4	WB**0301...	0.6
A08H-SWUBR03-D060	Steel	6	8	3.1	100	18	7.5	0°	-12°	0.4	WB**0301...	0.6
A08H-SWUBR03-D070	Steel	7	8	3.6	100	20	7.5	0°	-12°	0.4	WB**0301...	0.6
E05G-SWUBR/L03-D060	Carbide	6	5	3	90	10	4.8	0°	-13°	0.4	WB**0301...	0.6
E06H-SWUBR/L03-D070	Carbide	7	6	3.5	100	12	5.75	0°	-12°	0.4	WB**0301...	0.6
E07H-SWUBR/L03-D080	Carbide	8	7	4	100	14	6.75	0°	-11°	0.4	WB**0301...	0.6
E08K-SWUBR03-D060	Carbide	6	8	3.1	125	30	7.5	0°	-12°	0.4	WB**0301...	0.6
E08K-SWUBR03-D070	Carbide	7	8	3.6	125	40	7.5	0°	-12°	0.4	WB**0301...	0.6

*Torque: Recommended clamping torque (N-m)

**RE : Standard corner radius

Note: Use right-hand toolholders (SVUCR*) with left-hand inserts (L); and left-hand toolholders (SWUBL**) with right-hand inserts (R).

SPARE PARTS



Designation	Clamping screw	Wrench
A/E**-SWUBR/L...	CSTB-2	T-6F

Reference pages: Insert → 2-57

TC



**Triangular
with hole
Positive 7°**

S/C-STUC-OH

Screw-on boring bar, for positive 60° triangular inserts

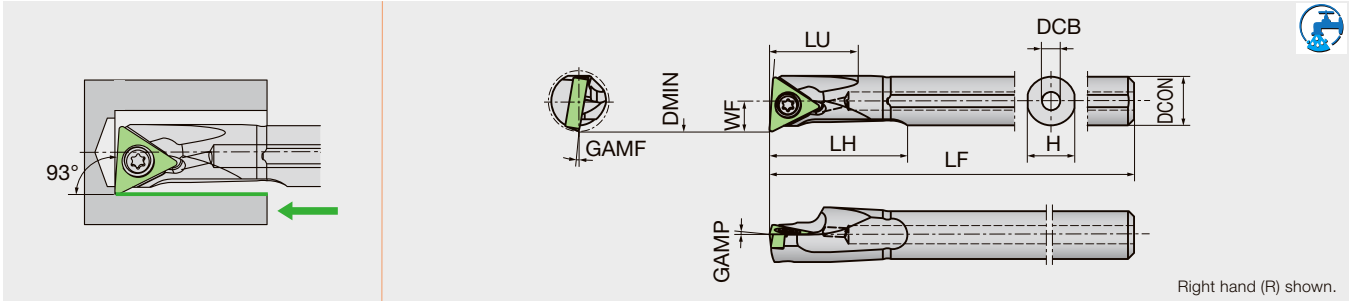

Designation	Material	DMIN	DCON	WF	LF	LH	H	GAMP	GAMF	RE*	DCB	LU	Insert
S07G-STUCR06D08-OH	Steel	8	7	4	90	19.5	6.75	0°	11°	0.2	2.5	12.5	TC..0601..
C07J-STUCR06D08-OH	Carbide	8	7	4	110	13	6.75	0°	11°	0.2	2	12.5	TC..0601..
C07J-STUCL06D08-OH	Carbide	8	7	4	110	13	6.75	0°	11°	0.2	2	12.5	TC..0601..

Use a left-handed insert
 For F05 chipbreaker, right-hand inserts fit to right-hand toolholder
 F05 chipbreaker evacuates chips BACKWARD
 *RE: Standard corner radius

SPARE PARTS



Designation	Clamp screw	Wrench (for Clamp screw)
S/C07G-STUCR/L06D08-OH	LR-S-2*4.4	CLR-13S

Reference pages: Insert → 2-36 -, CBN → 2-93 -, PCD → 2-122 -

Grade

Insert

Ext. Toolholder

Int. Toolholder

Threading

Grooving

Shaper

Endmill

Drilling Tool

Technical Reference

TP



**Triangular
with hole
Positive 11°**

STREAMJETBAR

A/E-STUPR/L

Screw-on boring bar, for positive 60° triangular inserts

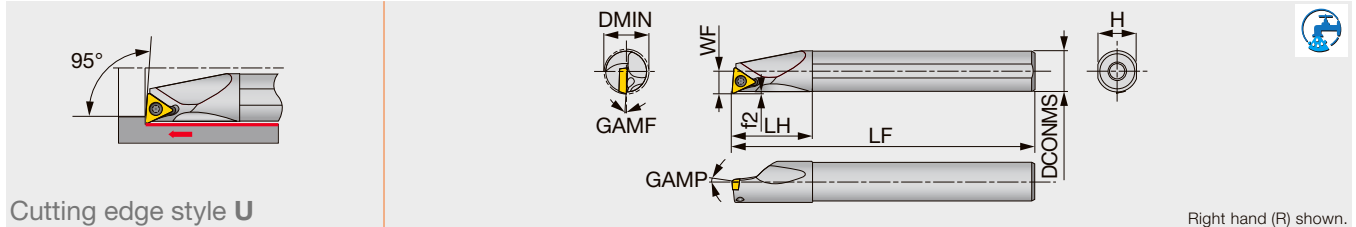

Cutting edge style U

Right hand (R) shown.

Designation	Material	DMIN	DCONMS	WF	LF	LH	H	f2	GAMP	GAMF	RE**	Insert	Torque*
A07G-STUPR/L07-D080	Steel	8	7	4	90	12	6.75	0.4	5°	-10°	0.4	TP**0701...	0.9
A08H-STUPR/L07-D080	Steel	8	8	4	100	19.5	7.5	0.5	5°	-10°	0.4	TP**0701...	0.9
A08H-STUPR/L09-D100	Steel	10	8	5.5	100	16	7.5	0.6	5°	-8°	0.4	TP**0902... ⁽¹⁾	0.9
A10F-STUPR1102-D120	Steel	12	10	6.5	80	20	9	1.4	5°	-6°	0.4	TP**1102... ⁽¹⁾	1.2
A10K-STUPR/L1102-D120	Steel	12	10	6.5	125	20	9	0.7	5°	-6°	0.4	TP**1102... ⁽¹⁾	1.2
A10K-STUPR/L1103-D120	Steel	12	10	6.5	125	20	9	0.6	5°	-10°	0.4	TP**1103... ⁽¹⁾	1.4
A12H-STUPR1102-D140	Steel	14	12	7	100	24	11	0.8	5°	-4°	0.4	TP**1102... ⁽¹⁾	1.2
A12M-STUPR/L1102-D140	Steel	14	12	7	150	24	11	0.8	5°	-4°	0.4	TP**1102... ⁽¹⁾	1.2
A12M-STUPR/L1103-D140	Steel	14	12	7	150	24	11	0.6	5°	-6°	0.4	TP**1103... ⁽¹⁾	1.4
A12H-STUPR1102-D160	Steel	16	12	9	100	24	11	0.6	5°	-3°	0.4	TP**1102... ⁽¹⁾	1.2
A12M-STUPR/L1102-D160	Steel	16	12	9	150	24	11	0.6	5°	-3°	0.4	TP**1102... ⁽¹⁾	1.2
A16K-STUPR13-D180	Steel	18	16	9	125	32	15	0.8	5°	-3°	0.4	TP**1303... ⁽¹⁾	1.4
A16Q-STUPR/L1103-D180	Steel	18	16	9	180	32	15	0.8	5°	-4°	0.4	TP**1103... ⁽¹⁾	1.4
A16Q-STUPR/L13-D180	Steel	18	16	9	180	32	15	0.8	5°	-3°	0.4	TP**1303... ⁽¹⁾	1.4
A16K-STUPR13-D200	Steel	20	16	11	125	32	15	0.6	5°	-3°	0.4	TP**1303... ⁽¹⁾	1.4
A16Q-STUPR/L13-D200	Steel	20	16	11	180	32	15	0.6	5°	-3°	0.4	TP**1303... ⁽¹⁾	1.4
A20R-STUPR/L1103-D220	Steel	22	20	11	200	36	18	0.7	5°	-2°	0.4	TP**1103... ⁽¹⁾	1.4
A20R-STUPR/L13-D220	Steel	22	20	11	200	36	18	0.7	5°	-2°	0.4	TP**1303... ⁽¹⁾	1.4
A25S-STUPR/L16-D270	Steel	27	25	13.5	250	45	23	0.5	5°	-1°	0.8	TP**16T3... ⁽¹⁾	3
A32T-STUPR/L16-D340	Steel	34	32	17	300	50	30	0.7	5°	0°	0.8	TP**16T3...	3
E07H-STUPR/L07-D080	Carbide	8	7	4	100	14	6.75	0.3	5°	-10°	0.4	TP**0701...	0.9
E08G-STUPR07-D080	Carbide	8	8	4	90	44.5	7.5	0.5	5°	-10°	0.4	TP**0701...	0.9
E08K-STUPR/L07-D080	Carbide	8	8	4	125	44.5	7.5	0.5	5°	-10°	0.4	TP**0701...	0.9
E08G-STUPR09-D100	Carbide	10	8	5.5	90	22	7	0.6	5°	-8°	0.4	TP**0902... ⁽¹⁾	0.9
E08K-STUPR/L09-D100	Carbide	10	8	5.5	125	22	7	0.6	5°	-8°	0.4	TP**0902... ⁽¹⁾	0.9
E10F-STUPR1102-D120	Carbide	12	10	6.5	80	25	9	0.5	5°	-6°	0.4	TP**1102... ⁽¹⁾	1.2
E10H-STUPR1102-D120	Carbide	12	10	6.5	100	25	9	0.6	5°	-6°	0.4	TP**1102... ⁽¹⁾	1.2
E10M-STUPR/L1102-D120	Carbide	12	10	6.5	150	25	9	0.6	5°	-6°	0.4	TP**1102... ⁽¹⁾	1.2
E10M-STUPR/L1103-D120	Carbide	12	10	6.5	150	25	9	0.7	5°	-10°	0.4	TP**1103... ⁽¹⁾	1.4
E12G-STUPR1102-D140	Carbide	14	12	7	90	27	11	0.8	5°	-4°	0.4	TP**1102... ⁽¹⁾	1.2
E12J-STUPR1102-D140	Carbide	14	12	7	110	27	11	0.8	5°	-4°	0.4	TP**1102... ⁽¹⁾	1.2
E12Q-STUPR/L1102-D140	Carbide	14	12	7	180	27	11	0.8	5°	-4°	0.4	TP**1102... ⁽¹⁾	1.2
E12Q-STUPR/L1103-D140	Carbide	14	12	7	180	27	11	0.7	5°	-6°	0.4	TP**1103... ⁽¹⁾	1.4
E12G-STUPR1102-D160	Carbide	16	12	9	90	27	11	0.6	5°	-3°	0.4	TP**1102... ⁽¹⁾	1.2
E12J-STUPR1102-D160	Carbide	16	12	9	110	27	11	0.6	5°	-3°	0.4	TP**1102... ⁽¹⁾	1.2
E12Q-STUPR/L1102-D160	Carbide	16	12	9	180	27	11	0.6	5°	-3°	0.4	TP**1102... ⁽¹⁾	1.2
E16H-STUPR13-D180	Carbide	18	16	9	100	32	15	0.9	5°	-3°	0.4	TP**1303... ⁽¹⁾	1.4
E16R-STUPR/L1103-D180	Carbide	18	16	9	200	32	15	0.8	5°	-3°	0.4	TP**1103... ⁽¹⁾	1.4
E16L-STUPR13-D180	Carbide	18	16	9	130	32	15	0.6	5°	-3°	0.4	TP**1303... ⁽¹⁾	1.4
E16R-STUPR/L13-D180	Carbide	18	16	9	200	32	15	0.6	5°	-3°	0.4	TP**1303... ⁽¹⁾	1.4
E16H-STUPR13-D200	Carbide	20	16	11	100	32	15	0.6	5°	-3°	0.4	TP**1303... ⁽¹⁾	1.4
E16L-STUPR13-D200	Carbide	20	16	11	130	32	15	0.6	5°	-3°	0.4	TP**1303... ⁽¹⁾	1.4
E16R-STUPR/L13-D200	Carbide	20	16	11	200	32	15	0.6	5°	-3°	0.4	TP**1303... ⁽¹⁾	1.4
E20S-STUPR1103-D220	Carbide	22	20	11	250	36	18	0.7	5°	-2°	0.4	TP**1103... ⁽¹⁾	1.4
E20S-STUPR13-D220	Carbide	22	20	11	250	36	18	0.6	5°	-2°	0.4	TP**1303... ⁽¹⁾	1.4
E25T-STUPR16-D270	Carbide	27	25	13.5	300	45	23	0.5	5°	-1°	0.8	TP**16T3...	3

*Torque: Recommended clamping torque (N-m) **RE : Standard corner radius

Note: Use right-hand toolholders (STUPR**) with left-hand inserts (L); and left-hand toolholders (STUPL**) with right-hand inserts (R).

(1) TPGH, TPGM, and TPGA inserts cannot be used.

Reference pages: Insert → 2-42 -, CBN → 2-94 -, PCD → 2-123 -

SPARE PARTS



Designation	Clamping screw	Wrench
A/E07*-STUPR/L07-..., A/E08*-STUPR/L07-..., A/E08*-STUPR/L09-...	CSTB-2.2L038	T-7F
A/E10*-STUPR/L1102-...	CSTB-2.5S	T-8F
A/E10*-STUPR/L1103-..., A/E12*-STUPR/L1103-...	CSTB-3L050	T-9F
A/E12*-STUPR/L1102-...	CSTB-2.5B	T-8F
A/E16*-STUPR/L1103-..., A/E16*-STUPR/L13-..., A/E20*-STUPR/L1103-...	CSTB-3S	T-9F
A/E20*-STUPR/L13-...	CSTB-3	T-9F
A/E25*-STUPR/L16-..., A32*-STUPR/L16-...	CSTB-4M	T-15F

S/C-STUP-OH

Screw-on boring bar, for positive 60° triangular inserts

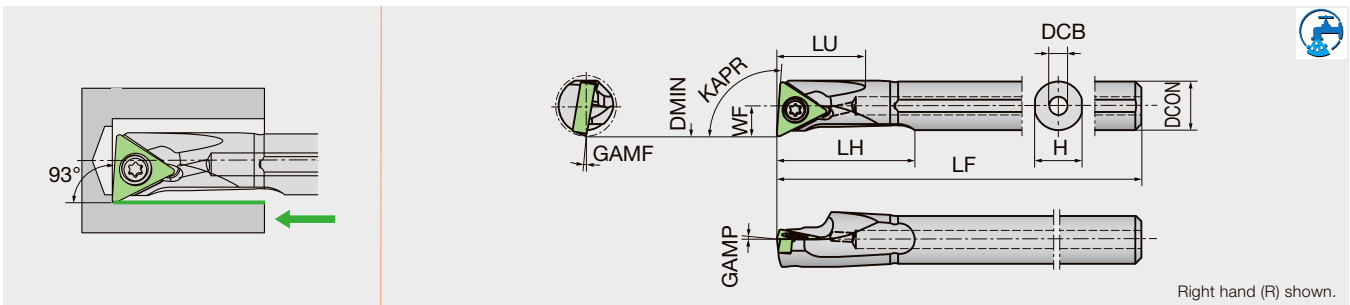

Designation	Material	DMIN	DCON	WF	LF	LH	H	GAMP	GAMF	RE*	DCB	LU	Insert
S08H-STUPR09D10-OH	Steel	10	8	5	100	22.5	7.7	5°	10°	0.4	3	14.5	TP..0902..
S10K-STUPR11D12-OH	Steel	12	10	6	125	27.5	9.6	5°	7.5°	0.4	3.5	18.5	TP..1103..
S12M-STUPR11D14-OH	Steel	14	12	7	150	32.5	11.5	5°	5°	0.4	4	22	TP..1103..
S16Q-STUPR11D18-OH	Steel	18	16	9	180	42.5	15.4	5°	3°	0.4	5	28.5	TP..1103..
S20Q-STUPR11D22-OH	Steel	22	20	11	180	46	19.4	5°	3°	0.4	5	38	TP..1103..
C08K-STUPR09D10-OH	Carbide	10	8	5	125	16.5	7.7	5°	10°	0.4	2.5	14.5	TP..0902..
C08K-STUPL09D10-OH	Carbide	10	8	5	125	16.5	7.7	5°	10°	0.4	2.5	14.5	TP..0902..
C10M-STUPR11D12-OH	Carbide	12	10	6	150	20	9.6	5°	7.5°	0.4	2.5	17.5	TP..1103..
C10M-STUPL11D12-OH	Carbide	12	10	6	150	20	9.6	5°	7.5°	0.4	2.5	17.5	TP..1103..
C12M-STUPR11D14-OH	Carbide	14	12	7	150	23	11.5	5°	5°	0.4	3	21.5	TP..1103..
C16Q-STUPR11D18-OH	Carbide	18	16	9	180	29	15.4	5°	3°	0.4	4	28	TP..1103..

Use a left-handed insert
 For F1/FG chipbreaker, right-hand inserts fit to right-hand toolholder
 F1/FG chipbreaker evacuates chips BACKWARD
 *RE: Standard corner radius

SPARE PARTS



Designation	Clamp screw	Wrench (for Clamp screw)
S/C*-STUPR/L09**	LR-S-2.5*4.8	CLR-15S
S/C*-STUPR/L11**	LR-S-3*5.8	RLR-20S

Reference pages: Insert → 2-42 -, CBN → 2-94 -, PCD → 2-123 -

TP



Triangular
with hole
Positive 11°

STREAMJETBAR

A/E-STFPR/L

Screw-on boring bar, for positive 60° triangular inserts

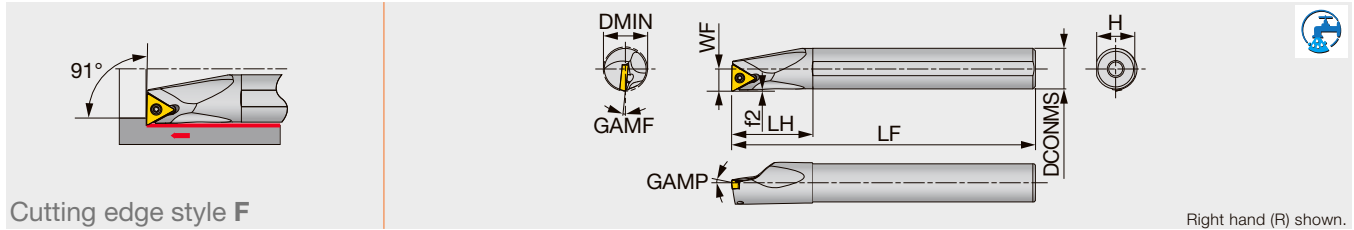

Cutting edge style F

Right hand (R) shown.

Designation	Material	DMIN	DCONMS	WF	LF	LH	H	f2	GAMP	GAMF	RE**	Insert	Torque*
A08H-STFPR/L09-D100	Steel	10	8	5.5	100	16	7.5	0.7	5°	-8°	0.4	TP**0902...	0.9
A10K-STFPR/L1102-D120	Steel	12	10	6.5	125	20	9	0.7	5°	-6°	0.4	TP**1102...	1.2
A12M-STFPR/L1102-D140	Steel	14	12	7.0	150	24	11	0.6	5°	-4°	0.4	TP**1102...	1.2
A16Q-STFPR/L13-D180	Steel	18	16	9	180	32	15	0.7	5°	-2°	0.4	TP**1303...	1.4
A20R-STFPR13-D220	Steel	22	20	11	200	36	18	0.8	5°	-2°	0.4	TP**1303...	1.4
A25S-STFPR16-D270	Steel	27	25	13.5	250	45	23	0.6	5°	-1°	0.4	TP**16T3...	3
E08K-STFPR/L09-D100	Carbide	10	8	5.5	125	22	7.5	0.7	5°	-8°	0.4	TP**0902...	0.9
E10M-STFPR/L1102-D120	Carbide	12	10	6.5	150	25	9	0.7	5°	-6°	0.4	TP**1102...	1.2
E12Q-STFPR/L1102-D140	Carbide	14	12	7	180	27	11	0.6	5°	-4°	0.4	TP**1102...	1.2
E16R-STFPR13-D180	Carbide	18	16	9	200	32	15	0.7	5°	-2°	0.4	TP**1303...	1.4
E20S-STFPR13-D220	Carbide	22	20	11	250	36	18	0.8	5°	-2°	0.4	TP**1303...	1.4

*Torque: Recommended clamping torque (N-m)

**RE : Standard corner radius

Note: Use right-hand toolholders (STFPR**) with left-hand inserts (L); and left-hand toolholders (STFPL**) with right-hand inserts (R).

(1) TPGH, TPGM, and TPGA inserts cannot be used.

SPARE PARTS



Designation	Clamping screw	Wrench
A08H-STFPR/L09-D100	CSTB-2.2S	T-7F
A10K-STFPR/L1102-D120	CSTB-2.5B	T-8F
A12M-STFPR/L1102-D140	CSTB-2.5	T-8F
A16Q-STFPR/L13-D180	CSTB-3S	T-9F
A20R-STFPR13-D220	CSTB-3	T-9F
A25S-STFPR16-D270	CSTB-4M	T-15F
E08K-STFPR/L09-D100	CSTB-2.2S	T-7F
E10M-STFPR/L1102-D120	CSTB-2.5B	T-8F
E12Q-STFPR/L1102-D140	CSTB-2.5	T-8F
E16R-STFPR13-D180	CSTB-3S	T-9F
E20S-STFPR13-D220	CSTB-3	T-9F

Reference pages: Insert → [2-42 -](#), CBN → [2-94 -](#), PCD → [2-123 -](#)

YW

 **Rhombic, 25°**
with hole
Positive 7°

STREAMJETBAR

A/E-SYQBR/L

Screw-on boring bar, for positive 25° rhombic inserts

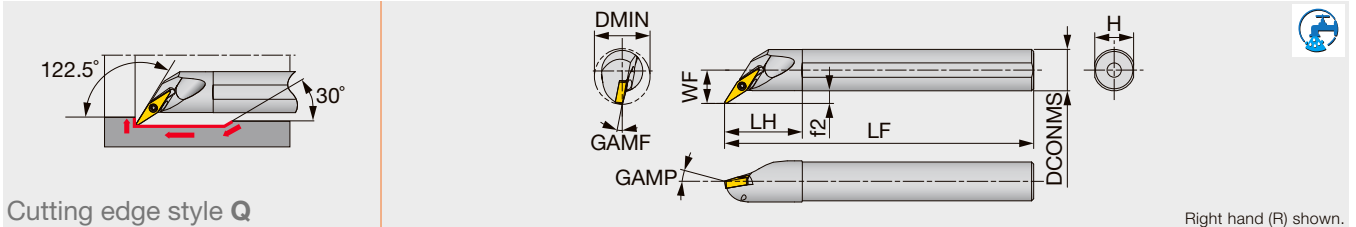

Cutting edge style Q

Right hand (R) shown.

Designation	Material	DMIN	DCONMS	WF	LF	LH	H	f2	GAMP	GAMF	RE**	Insert	Torque*
A12M-SYQBR/L11-D170	Steel	17	12	10.5	150	24	11	4.5	-5°	-10°	0.4	YW**11T2...	0.6
A16Q-SYQBR/L11-D215	Steel	21.5	16	13	180	30	15	5	-5°	-8°	0.4	YW**11T2...	0.6
E12Q-SYQBR/L11-D170	Carbide	17	12	10.5	180	27	11	4.5	-5°	-10°	0.4	YW**11T2...	0.6
E16R-SYQBR/L11-D215	Carbide	21.5	16	13	200	32	15	5	-5°	-8°	0.4	YW**11T2...	0.6

*Torque: Recommended clamping torque (N-m)

**RE : Standard corner radius

SPARE PARTS

Designation	Clamping screw	Wrench
A**-SYQBR/L11-D...	CSTB-2L	T-6F
E**-SYQBR/L11-D...	CSTB-2L	T-6F

TC

 **Triangular**
with hole
Positive 7°

C-STZC/ZP-OH

Screw-on boring bar, for positive 60° triangular inserts

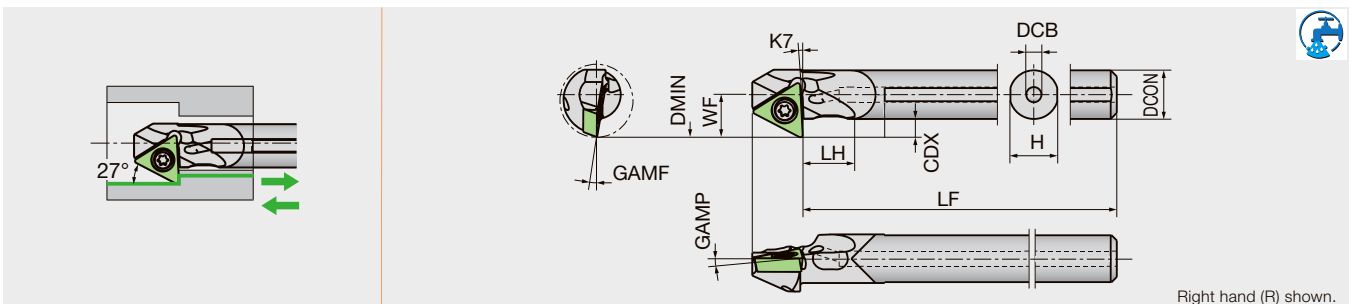

Right hand (R) shown.

Designation	DMIN	DCON	WF	LF	LH	H	GAMP	GAMF	RE*	CDX	DCB	Insert
C06H-STZCR06D10-OH	10	6	5.5	100	6	5.8	0°	10°	0.2	2.5	2	TC..0601..
C08K-STZPR09D12-OH	12	8	7	125	8.5	7.7	5°	10°	0.4	3	2.5	TP..0902..
C10M-STZPR09D14-OH	14	10	8	150	12	9.6	5°	7°	0.4	3	2.5	TP..0902..
C12M-STZPR11D175-OH	17.5	12	10.5	150	14.5	11.5	5°	5°	0.4	4.5	3	TP..1103..

SPARE PARTS

Designation	Clamp screw	Wrench (for Clamp screw)
C06H-STZCR06D10-OH	LR-S-2*4.4	CLR-13S
C**-STZPR09**	LR-S-2.5*4.8	CLR-15S
C12M-STZPR11D175-OH	LR-S-3*5.8	RLR-20S

Use a left-handed insert

For F05 chipbreaker, right-hand inserts fit to right-hand toolholder

F05 chipbreaker evacuates chips BACKWARD

*RE: Standard corner radius

Reference pages: A/E-SYQBR/L: Insert → 2-59

C-STZC/ZP-OH: Insert → 2-36 -, 2-42 -, CBN → 2-93 -, 2-94 -, PCD → 2-122 -, 2-123 -

Grade

Insert

Ext. Toolholder

Int. Toolholder

Threading

Grooving

Shaper

Endmill

Drilling Tool

Technical Reference

DC

Rhombic, 55°
with hole
Positive 7°



STREAMJETBAR

A/E-SDZCR/L

Screw-on boring bar, for positive 55° rhombic inserts

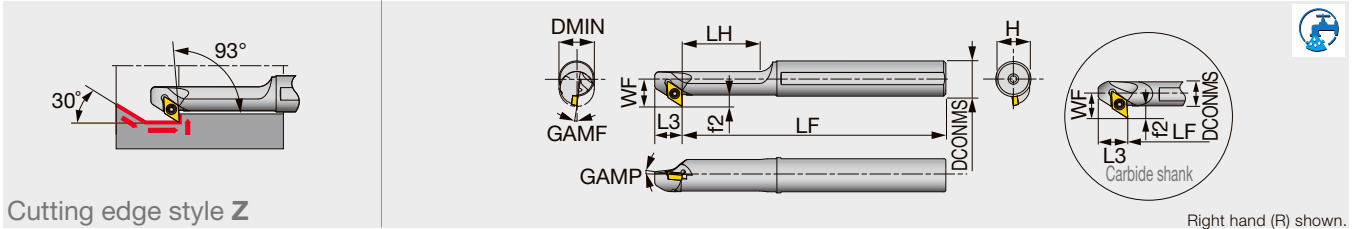

Right hand (R) shown.

Designation	Material	DMIN	DCONMS	WF	LF	LH	L3	H	f2	GAMP	GAMF	RE**	Insert	Torque*
A12M-SDZCR/L07-D140	Steel	14	12	10.5	150	30	12.5	11	4.5	0°	-9°	0.4	DC**0702...	1.2
A16Q-SDZCR/L07-D160	Steel	16	16	12.5	180	35	12.5	15	4.5	0°	-8°	0.4	DC**0702...	1.2
A20R-SDZCR/L11-D200	Steel	20	20	15.5	200	40	15.0	18	5.5	0°	-8°	0.8	DC**11T3...	3
A25S-SDZCR/L11-D250	Steel	25	25	18	250	50	15	23	5.5	0°	-6°	0.8	DC**11T3...	3
E12Q-SDZCR/L07-D180	Carbide	18	12	10.5	180	-	12.5	11	4.5	0°	-8°	0.4	DC**0702...	1.2
E16R-SDZCR/L07-D220	Carbide	22	16	12.5	200	-	12.5	15	4.5	0°	-6°	0.4	DC**0702...	1.2

*Torque: Recommended clamping torque (N-m)

**RE : Standard corner radius

Note: Use right-hand toolholders (SDZCR**) with right-hand inserts (R); and left-hand toolholders (SDZCL**) with left-hand inserts (L).

SPARE PARTS

Designation	Clamping screw	Wrench
A1**-SDZCR/L07-D1*0	CSTB-2.5	T-8F
E1**-SDZCR/L07-D**0		
A2**-SDZCR/L11-D2*0	CSTB-4S	T-15F

VC

Rhombic, 35°
with hole
Positive 7°



STREAMJETBAR

A-SVZCR/L

Screw-on boring bar, for positive 35° rhombic inserts

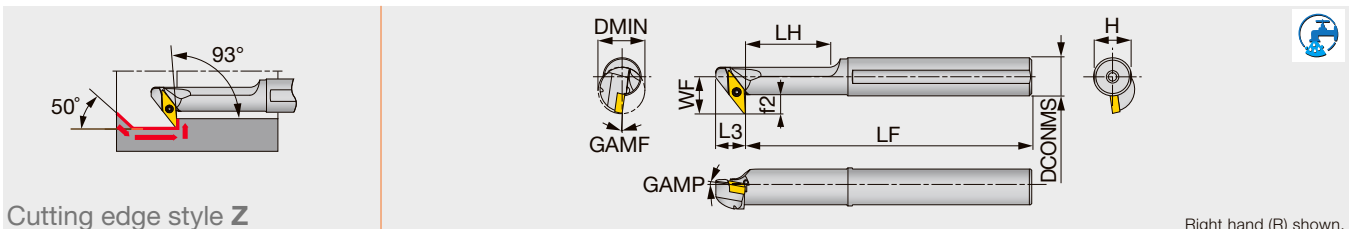

Right hand (R) shown.

Designation	Material	DMIN	DCONMS	WF	LF	LH	L3	H	f2	GAMP	GAMF	RE**	Insert	Torque*
A12M-SVZCR/L08-D160	Steel	16	12	11	150	30	10	11	5.5	0°	-8°	0.4	VC**0802...	0.6

*Torque: Recommended clamping torque (N-m)

**RE : Standard corner radius

Note: Use right-hand toolholders (SVZCR**) with right-hand inserts (R); and left-hand toolholders (SVZCL**) with left-hand inserts (L).

SPARE PARTS

Designation	Clamping screw	Wrench
A12M-SVZCR/L08-D160	CSTB-2L	T-6F

Reference pages: A/E-SDZCR/L: Insert → 2-23 -, CBN → 2-91 -, PCD → 2-120 -
A-SVZCR/L: Insert → 2-50 -, CBN → 2-101, PCD → 2-127

VB

Rhombic, 35°
with hole
Positive 5°



STREAMJETBAR

A-SVZBR/L

Screw-on boring bar, for positive 35° rhombic inserts

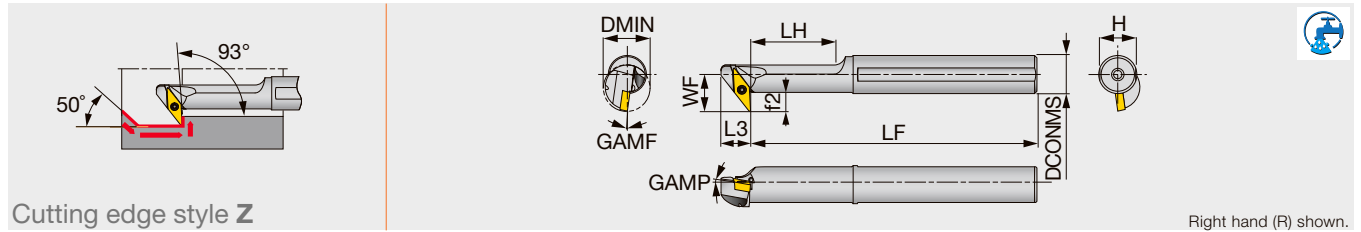

Cutting edge style Z

Right hand (R) shown.

Designation	Material	DMIN	DCONMS	WF	LF	LH	L3	H	f2	GAMP	GAMF	RE**	Insert	Torque*
A16Q-SVZBR/L11-D200	Steel	20	16	15.5	180	35	12.5	15	8	0°	-8°	0.4	VB**1103...	1.2
A20R-SVZBR/L11-D250	Steel	25	20	17.5	200	40	12.5	18	8	0°	-7°	0.4	VB**1103...	1.2
A25S-SVZBR/L16-D320	Steel	32	25	24	250	50	17.5	23	12	0°	-6°	0.8	VB**1604...	3
A32T-SVZBR/L16-D400	Steel	40	32	27.5	300	72	17.5	30	12	0°	-5°	0.8	VB**1604...	3

*Torque: Recommended clamping torque (N-m)

**RE : Standard corner radius

Note: Use right-hand toolholders (SVZBR**) with right-hand inserts (R); and left-hand toolholders (SVZBL**) with left-hand inserts (L).

SPARE PARTS

Designation	Clamping screw	Wrench
A**-SVZBR/L11-D2*0	CSTB-2.5	T-8F
A25S-SVZBR/L16-D320	CSTB-3.5	T-15F
A32T-SVZBR/L16-D400	CSTB-3.5L	T-15F

EP

Rhombic, 75°
with hole
Positive 11°



STREAMJETBAR

A/E-SEZPR/L

Screw-on boring bar, for positive 75° rhombic inserts

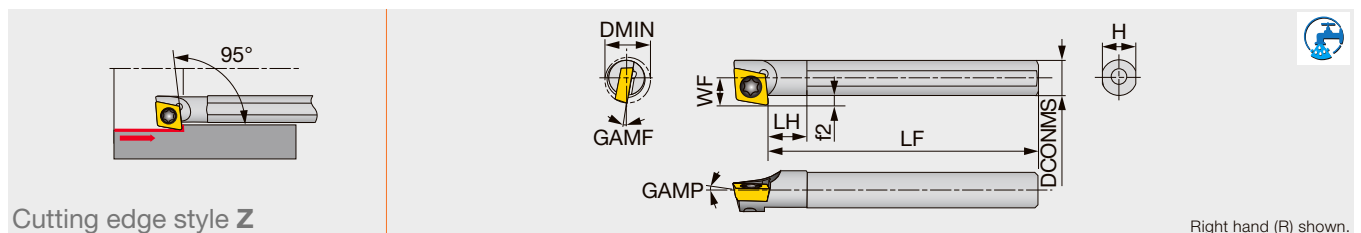

Cutting edge style Z

Right hand (R) shown.

Designation	Material	DMIN	DCONMS	WF	LF	LH	H	f2	GAMP	GAMF	RE**	Insert	Torque*
A04F-SEZPR/L03-D055	Steel	5.5	4	3.2	80	4	3.8	1.2	0°	-8°	0.2	EP**03X1...	0.6
A05F-SEZPR/L03-D065	Steel	6.5	5	3.7	80	5	4.8	1.2	0°	-6°	0.2	EP**03X1...	0.6
E04G-SEZPR/L03-D055	Carbide	5.5	4	3.2	90	5	3.8	1.2	0°	-8°	0.2	EP**03X1...	0.6
E05G-SEZPR/L03-D065	Carbide	6.5	5	3.7	90	6	4.8	1.2	0°	-6°	0.2	EP**03X1...	0.6

*Torque: Recommended clamping torque (N-m)

**RE : Standard corner radius

Note: Use right-hand toolholders (SEZPR**) with right-hand inserts (R); and left-hand toolholders (SEZPL**) with left-hand inserts (L).

SPARE PARTS

Designation	Clamping screw	Wrench
A**-SEZPR/L03-D...	CSTA-1.6	T-6F
E**-SEZPR/L03-D...	CSTA-1.6	T-6F

Reference pages: A-SVZBR/L: Insert → 2-48 -, CBN → 2-99 -, PCD → 2-127
A/E-SEZPR/L: Insert → 2-34 -, CBN → 2-93, PCD → 2-122

Grade

Insert

Ext. Toolholder

Int. Toolholder

Threading

Grooving

Shaper

Endmill

Drilling Tool

Technical Reference

VC

Rhombic, 35°
with hole
Positive 7°



STREAMJET BAR

A-SVJCR/L

Screw-on boring bar, for positive 35° rhombic inserts

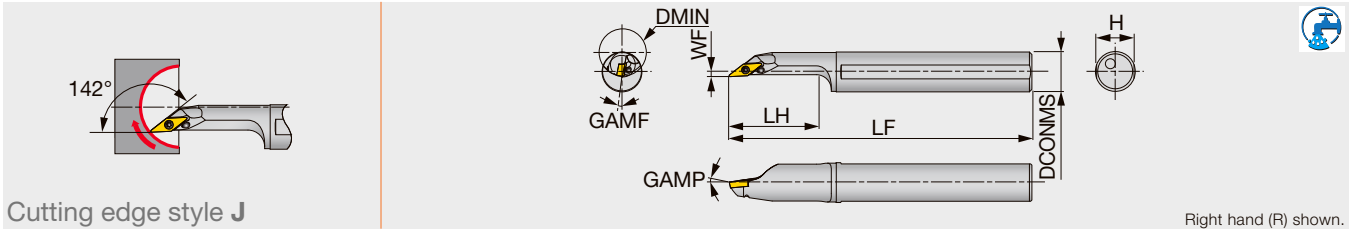

Cutting edge style J

Right hand (R) shown.

Designation	Material	DMIN	DCONMS	WF	LF	LH	H	GAMP	GAMF	RE**	Insert	Torque*
A12M-SVJCR/L08-D160	Steel	16	12	2	150	28	11	-5°	-5°	0.4	VC**0802...	0.6
A16Q-SVJCR/L08-D200	Steel	20	16	2	180	35	15	-5°	-5°	0.4	VC**0802...	0.6

*Torque: Recommended clamping torque (N-m)

**RE : Standard corner radius

Note: Use right-hand toolholders (SVJCR**) with left-hand inserts (L); and left-hand toolholders (SVJCL**) with right-hand inserts (R).

SPARE PARTS

Designation	Clamping screw	Wrench
A**-SVJC*08-D...	CSTB-2L	T-6F

WX

Trigon, 80°
with hole



MINIFORCE TURN

A/E-SWLXR/L

Screw-on boring bar, for WXGU inserts

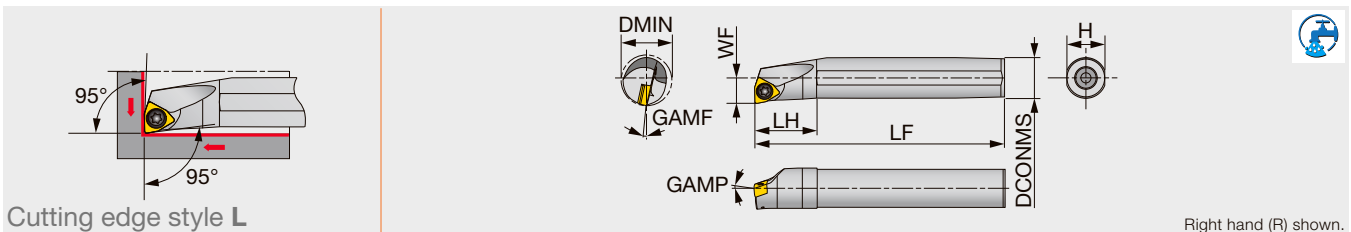

Cutting edge style L

Right hand (R) shown.

Designation	Material	DMIN	DCONMS	WF	LF	LH	H	GAMP	GAMF	RE**	Insert	Torque*
A10K-SWLXR/L04-D120	Steel	12	10	6	125	20	9	-10°	-16°	0.4	WXGU0403**L/R...	0.9
A12M-SWLXR/L04-D140	Steel	14	12	7	150	24	11	-10°	-14°	0.4	WXGU0403**L/R...	0.9
A16Q-SWLXR/L04-D180	Steel	18	16	9	180	32	15	-10°	-11°	0.4	WXGU0403**L/R...	0.9
A20R-SWLXR/L04-D220	Steel	22	20	11	200	36	18	-10°	-10°	0.4	WXGU0403**L/R...	0.9
E10M-SWLXR/L04-D120	Carbide	12	10	6	150	25	9	-10°	-16°	0.4	WXGU0403**L/R...	0.9
E12Q-SWLXR/L04-D140	Carbide	14	12	7	180	27	11	-10°	-14°	0.4	WXGU0403**L/R...	0.9
E16R-SWLXR/L04-D180	Carbide	18	16	9	200	32	15	-10°	-11°	0.4	WXGU0403**L/R...	0.9
E20S-SWLXR/L04-D220	Carbide	22	20	11	250	36	18	-10°	-10°	0.4	WXGU0403**L/R...	0.9

*Torque: Recommended clamping torque (N-m) **RE: Standard corner radius

Note: Use right-hand toolholders (R) with left-hand inserts (L); and left-hand toolholders (L) with right-hand inserts (R)

SPARE PARTS

Designation	Clamping screw	Wrench
A/E**-SWLXR/L....	SR34-514	T-7F

Reference pages: A-SVJCR/L: Insert → 2-50 -, CBN → 2-101, PCD → 2-127

A/E-SWLXR/L: Insert → 2-58, CBN → 2-102

DX

 **Rhombic, 55° with hole**

MINIFORCE A/E-SDXXR/L

Screw-on boring bar, for DXGU inserts

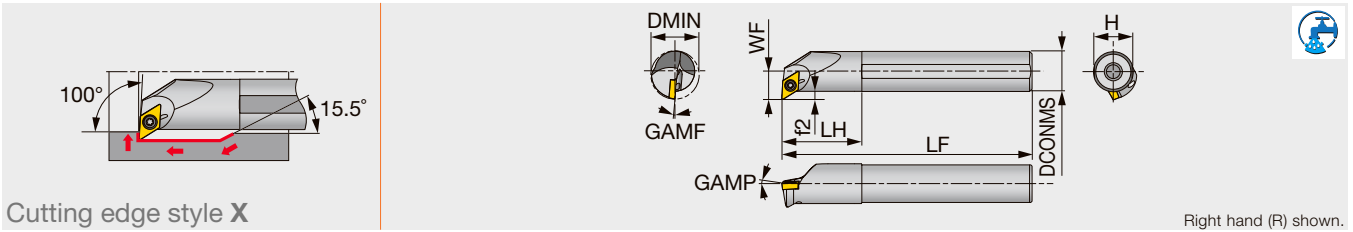

Cutting edge style X

Right hand (R) shown.

Designation	Material	DMIN	DCONMS	WF	LF	LH	H	f2	GAMP	GAMF	RE**	Insert	Torque*
A10K-SDXXR/L07-D130	Steel	13	10	7.6	125	20	9	2.6	-14°	-16°	0.4	DXG/MU0703**L/R...	0.9
A12M-SDXXR/L07-D160	Steel	16	12	8.6	150	24	11	2.6	-14°	-14°	0.4	DXG/MU0703**L/R...	0.9
A16Q-SDXXR/L07-D200	Steel	20	16	10.6	180	32	15	2.6	-13°	-13°	0.4	DXG/MU0703**L/R...	0.9
A20R-SDXXR/L07-D240	Steel	24	20	12.6	200	36	18	2.6	-13°	-12°	0.4	DXG/MU0703**L/R...	0.9
E10M-SDXXR/L07-D130	Carbide	13	10	7.6	150	25	9	2.6	-14°	-16°	0.4	DXG/MU0703**L/R...	0.9
E12Q-SDXXR/L07-D160	Carbide	16	12	8.6	180	27	11	2.6	-14°	-14°	0.4	DXG/MU0703**L/R...	0.9
E16R-SDXXR/L07-D200	Carbide	20	16	10.6	200	32	15	2.6	-13°	-13°	0.4	DXG/MU0703**L/R...	0.9
E20S-SDXXR/L07-D240	Carbide	24	20	12.6	250	36	18	2.6	-13°	-12°	0.4	DXG/MU0703**L/R...	0.9

*Torque: Recommended clamping torque (N-m) **RE : Standard corner radius

Note: Use right-hand toolholders (R) with left-hand inserts (L); and left-hand toolholders (L) with right-hand inserts (R)

SPARE PARTS

Designation	Clamping screw	Wrench
A/E**-SDXXR/L...	SR34-514	T-7F

A/E-SDZXR/L

Screw-on boring bar, for DXGU inserts

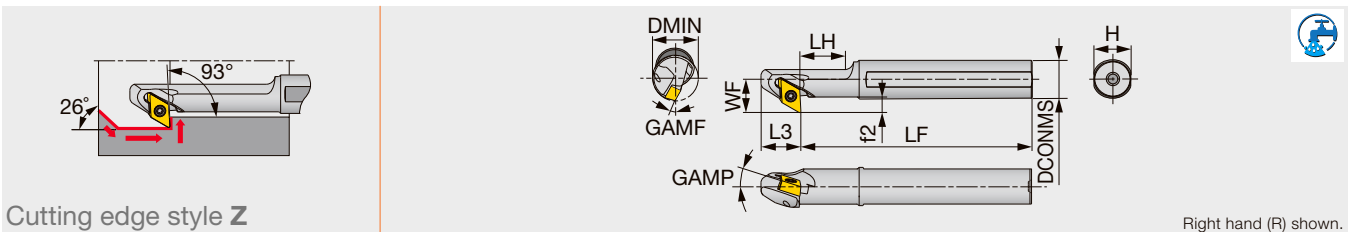

Cutting edge style Z

Right hand (R) shown.

Designation	Material	DMIN	DCONMS	WF	LF	LH	L3	H	f2	GAMP	GAMF	RE**	Insert	Torque*
A12M-SDZXR/L07-D140	Steel	14	12	10.5	150	30	13	11	4.5	-10°	-14°	0.4	DXG/MU0703**R/L...	0.9
A16Q-SDZXR/L07-D160	Steel	16	16	12.5	180	35	13	15	4.5	-10°	-12.5°	0.4	DXG/MU0703**R/L...	0.9
A20R-SDZXR/L07-D200	Steel	20	20	14.5	200	40	13	18	4.5	-10°	-10.5°	0.4	DXG/MU0703**R/L...	0.9
E12Q-SDZXR/L07-D180	Carbide	18	12	10.5	180	-	13	11	4.5	-11°	-11°	0.4	DXG/MU0703**R/L...	0.9
E16R-SDZXR/L07-D220	Carbide	22	16	12.5	200	-	13	15	4.5	-11°	-9°	0.4	DXG/MU0703**R/L...	0.9

*Torque: Recommended clamping torque (N-m) **RE : Standard corner radius

Note: Use right-hand toolholders (R) with right-hand inserts (R); and left-hand toolholders (L) with left-hand inserts (L).

SPARE PARTS

Designation	Clamping screw	Wrench
A/E**-SDZXR/L...	SR34-514	T-7F

Reference pages: : Insert → [2-32](#) -

Grade
Insert
Ext. Toolholder
Int. Toolholder
Threading
Grooving
Shaper
Endmill
Drilling Tool
Technical Reference

LBMA

Screw-on toolholder for boring insert

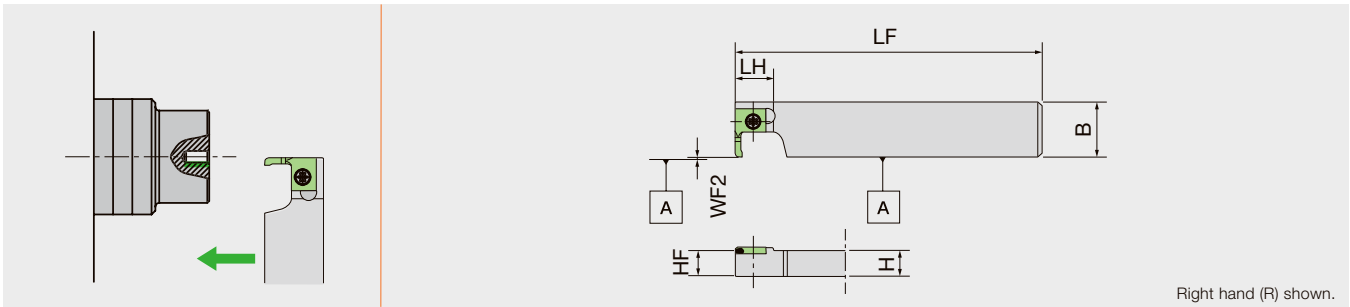

Designation	DMIN	H	B	LF	LH	HF	WF	WF2	Insert
LBMAR08	1 - 3	8	21.5	120	15	8	-	0	LBM..
LBMAR10	1 - 3	10	21.5	120	15	10	-	0	LBM..
LBMAR12	1 - 3	12	21.5	120	15	12	-	0	LBM..
LBMAR16	1 - 3	16	21.5	120	15	16	-	0	LBM..

SPARE PARTS



Designation	Clamp screw	Wrench (for Clamp screw)
LBMAR08	LRIS-4*10	LLR-25S
LBMAR10	LRIS-4*10PW	CLR-15S
LBMAR12	LRIS-4*10PW	CLR-15S
LBMAR16	LRIS-4*12PW	CLR-15S

LBMA-S

Screw-on toolholder for boring insert

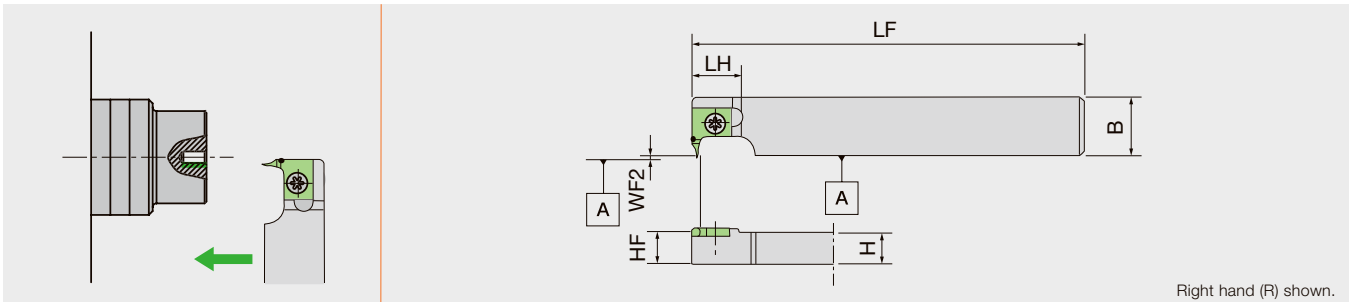

Designation	DMIN	H	B	LF	LH	HF	WF	WF2	Insert
LBMAR10SGX	1 - 2.3	10	18	85	15	10	-	0	LBMD..S
LBMAR10S	1 - 2.3	10	18	120	15	10	-	0	LBMD..S
LBMAR12S	1 - 2.3	12	18	120	15	12	-	0	LBMD..S

SPARE PARTS



Designation	Clamp screw	Wrench (for Clamp screw)
LBMAR10**	LRIS-4*10PW	CLR-15S
LBMAR12S	LRIS-4*12PW	CLR-15S

DS-LBMB

Screw-on round-shank toolholder for boring insert

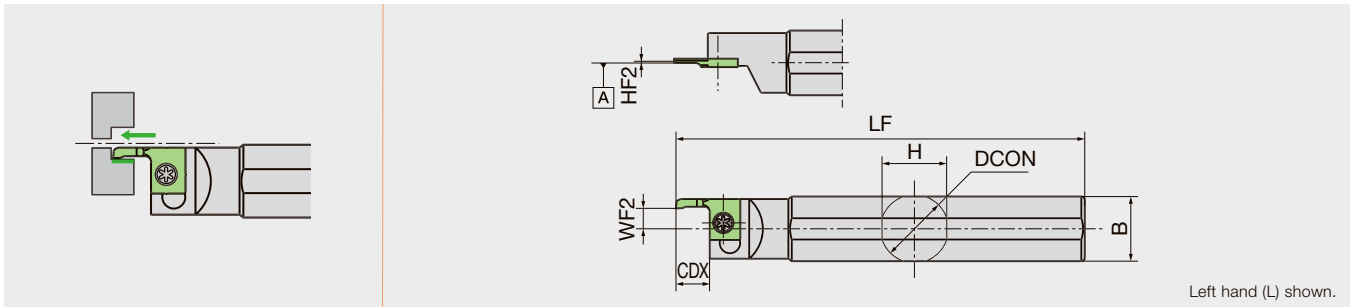

Designation	DMIN	H	B	LF	CDX	DCON	HF2	WF	WF2	Insert
DS-LBMBL14F	1 - 3	13	13	80	10	14	0	-	6.35	LBM.. LBMD..S
DS-LBMBL15H	1 - 3	15	15	100	10	15.875	0	-	6.35	LBM.. LBMD..S
DS-LBMBL16X	1 - 3	15	15	95	10	16	0	-	6.35	LBM.. LBMD..S
DS-LBMBL19	1 - 3	18	18	120	10	19.05	0	-	6.35	LBM.. LBMD..S
DS-LBMBL20	1 - 3	19	19	120	10	20	0	-	6.35	LBM.. LBMD..S
DS-LBMBL22	1 - 3	21	21	120	10	22	0	-	6.35	LBM.. LBMD..S
DS-LBMBL25	1 - 3	24	24	150	10	25.4	0	-	6.35	LBM.. LBMD..S
DS-LBMBL25-MET	1 - 3	24	24	120	10	25	0	-	6.35	LBM.. LBMD..S

SPARE PARTS



Designation	Clamp screw	Wrench (for Clamp screw)
DS-LBMBL**	LRIS-4*10PW	CLR-15S

CH-LBM

Screw-on toolholder for boring insert, for horizontal gang style tool post

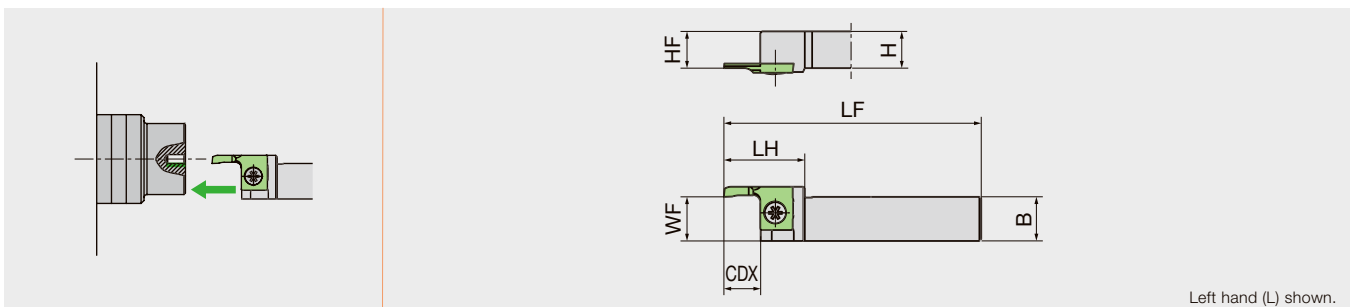

Designation	DMIN	H	B	LF	LH	CDX	HF	WF	Insert
CH-LBML1012H	1 - 3	10	12	100	22	10	10	12.35	LBM.. LBMD..S
CH-LBML1212H	1 - 3	12	12	100	22	10	12	12.35	LBM.. LBMD..S

SPARE PARTS



Designation	Clamp screw	Wrench (for Clamp screw)
CH-LBML**	LRIS-4*10PW	CLR-15S

Reference pages: : Insert → 4-32 -

Grade
Insert
Ext. Toolholder
Int. Toolholder
Threading
Grooving
Shaper
Endmill
Drilling Tool
Technical Reference

INSERT

LBMD-S

Short type

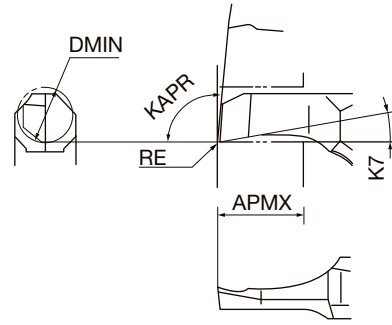
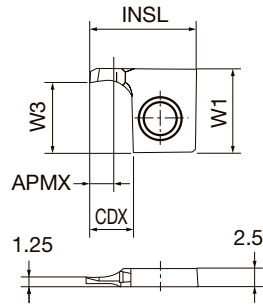

Left hand (L) shown.

P	Steel	★
M	Stainless	☆
N	Non-ferrous	
S	Superalloys	
H	Hard materials	

★ : First choice
☆ : Second choice

Designation	HAND	Coated		DMIN	APMX	CDX	INSL	K7	KAPR	W1	W3	RE
		VM1										
LBMD1020FLPB05S	L	●	Ⓜ	1	2	6	15	10°	95°	12	10	0.05
LBMD1020FLVBS	L	●	Ⓜ	1	2	6	15	10°	95°	12	10	0
LBMD1430FLPB05S	L	●	Ⓜ	1.4	3	6	15	10°	95°	12	10	0.05
LBMD1430FLVBS	L	●	Ⓜ	1.4	3	6	15	10°	95°	12	10	0
LBMD1730FLPB05S	L	●	Ⓜ	1.7	3	6	15	10°	95°	12	10	0.05
LBMD1730FLVBS	L	●	Ⓜ	1.7	3	6	15	10°	95°	12	10	0
LBMD2035FLPB05S	L	●	Ⓜ	2	3.5	6	15	10°	95°	12	10	0.05
LBMD2035FLVBS	L	●	Ⓜ	2	3.5	6	15	10°	95°	12	10	0
LBMD2335FLPB05S	L	●	Ⓜ	2.3	3.5	6	15	10°	95°	12	10	0.05
LBMD2335FLVBS	L	●	Ⓜ	2.3	3.5	6	15	10°	95°	12	10	0

● : Line up

INSERT

LBM

Long type

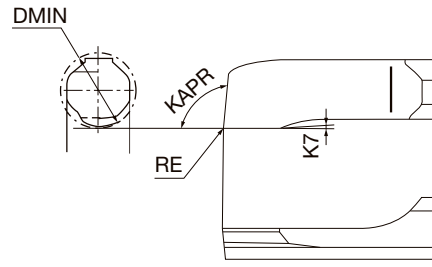
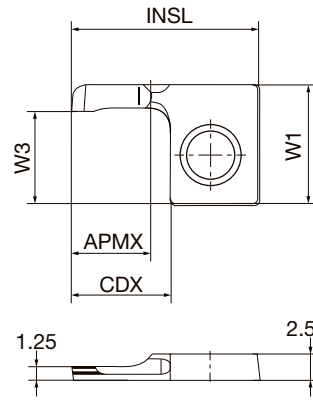

Left hand (L) shown.

P	Steel	★	☆
M	Stainless	☆	★
N	Non-ferrous		★
S	Superalloys		
H	Hard materials		

★ : First choice
☆ : Second choice

Designation	HAND	Coated			DMIN	APMX	CDX	INSL	K7	KAPR	W1	W3	RE
		VM1	ZM3										
LBMD1020FLPB05	L	●		Ⓜ	1	2	9.9	18.9	10°	95°	12	10	0.05
LBMD1020FLVB	L	●		Ⓜ	1	2	9.9	18.9	10°	95°	12	10	0
LBMD2060FLPB05	L	●		Ⓜ	2	6	9.9	18.9	10°	95°	12	10	0.05
LBMD2060FLVB	L	●		Ⓜ	2	6	9.9	18.9	10°	95°	12	10	0
LBME2060FLP05	L	●		Ⓜ	2	6	9.9	18.9	2°	105°	12	10	0.05
LBME2060FLPB05	L	●		Ⓜ	2	6	9.9	18.9	2°	105°	12	10	0.05
LBME2060FLV	L	●		Ⓜ	2	6	9.9	18.9	2°	105°	12	10	0
LBME2060FLVB	L	●		Ⓜ	2	6	9.9	18.9	2°	105°	12	10	0
LBM3080FLPB05	L	●		Ⓜ	3	8	9.9	18.9	2°	90°	12	9.6	0.05
LBM3080FLVB	L	●		Ⓜ	3	8	9.9	18.9	2°	90°	12	9.6	0
LBMC3080FLP05	L	●	●	Ⓜ	3	8	9.9	18.9	2°	95°	12	9.6	0.05
LBMC3080FLPB05	L	●	●	Ⓜ	3	8	9.9	18.9	2°	95°	12	9.6	0.05
LBMC3080FLV	L	●	●	Ⓜ	3	8	9.9	18.9	2°	95°	12	9.6	0
LBMC3080FLVB	L	●	●	Ⓜ	3	8	9.9	18.9	2°	95°	12	9.6	0

● : Line up

Grade 1
Insert 2
Ext. Toolholder 3
Int. Toolholder 4
Threading 5
Grooving 6
Shaper 7
Endmill 8
Drilling Tool 9
Technical Reference 10

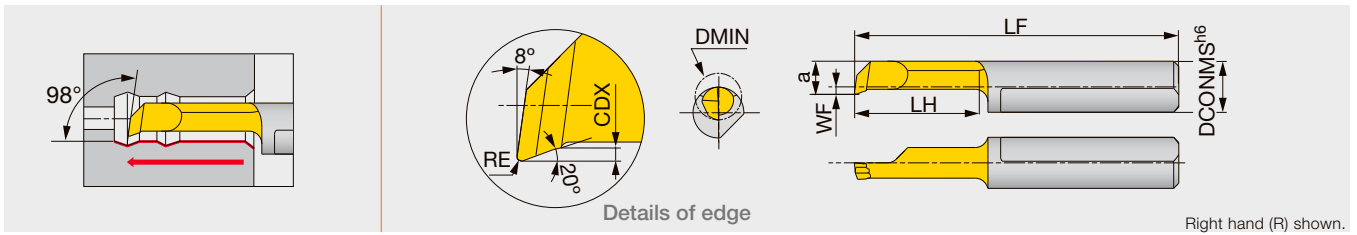

Designation	SH725	DMIN	DCONMS	WF	a	LF	LH	CDX	RE ^{+0.05} ₀
TBTR04045005-D010	●	1	4	-1.1	0.9	21	4.5	0.1	0.05
TBTR04065005-D010	●	1	4	-1.1	0.9	23	6.5	0.1	0.05
TBTR04040005-D020	●	2	4	-0.3	1.7	20.5	4	0.1	0.05
TBTR04090005-D020	●	2	4	-0.3	1.7	25.5	9	0.1	0.05
TBTR04140005-D020	●	2	4	-0.3	1.7	30.5	14	0.1	0.05
TBTR/L04090010-D028	●	2.8	4	0.9	2.6	25.5	9	0.2	0.1
TBTR04150010-D028	●	2.8	4	0.9	2.6	31.5	15	0.2	0.1
TBTR04190010-D028	●	2.8	4	0.9	2.6	35.5	19	0.2	0.1
TBTR04090010-D040	●	4	4	1.5	3.5	25.5	9	0.3	0.1
TBTR04150010-D040	●	4	4	1.5	3.5	31.5	15	0.3	0.1
TBTR04190010-D040	●	4	4	1.5	3.5	35.5	19	0.3	0.1
TBTR04230010-D040	●	4	4	1.5	3.5	39.5	23	0.3	0.1
TBTR04270010-D040	●	4	4	1.5	3.5	43.5	27	0.3	0.1
TBTR07090015-D050	●	5	7	0.9	4.4	25	9	0.5	0.15
TBTR07140015-D050	●	5	7	0.9	4.4	30	14	0.5	0.15
TBTR07190015-D050	●	5	7	0.9	4.4	35	19	0.5	0.15
TBTR07240015-D050	●	5	7	0.9	4.4	40	24	0.5	0.15
TBTR07290015-D050	●	5	7	0.9	4.4	45	29	0.5	0.15
TBTR07340015-D050	●	5	7	0.9	4.4	50	34	0.5	0.15
TBTR07140015-D060	●	6	7	1.8	5.3	30	14	0.5	0.15
TBTR/L07210015-D060	●	6	7	1.8	5.3	37	21	0.5	0.15
TBTR07240015-D060	●	6	7	1.8	5.3	40	24	0.5	0.15
TBTR07290015-D060	●	6	7	1.8	5.3	45	29	0.5	0.15
TBTR07340015-D060	●	6	7	1.8	5.3	50	34	0.5	0.15
TBTR07410015-D060	●	6	7	1.8	5.3	57	41	0.5	0.15
TBTR07190015-D068	●	6.8	7	2.8	6.3	35	19	0.6	0.15
TBTR07240015-D068	●	6.8	7	2.8	6.3	40	24	0.6	0.15
TBTR07290015-D068	●	6.8	7	2.8	6.3	45	29	0.6	0.15
TBTR07340015-D070	●	7	7	2.8	6.3	50	34	0.6	0.15
TBTR07390015-D070	●	7	7	2.8	6.3	55	39	0.6	0.15
TBTR07440015-D070	●	7	7	2.8	6.3	60	44	0.6	0.15
TBTR07490015-D070	●	7	7	2.8	6.3	65	49	0.6	0.15

● : Line up

JBTR/L

Solid boring bar for boring, profiling, and chamfering

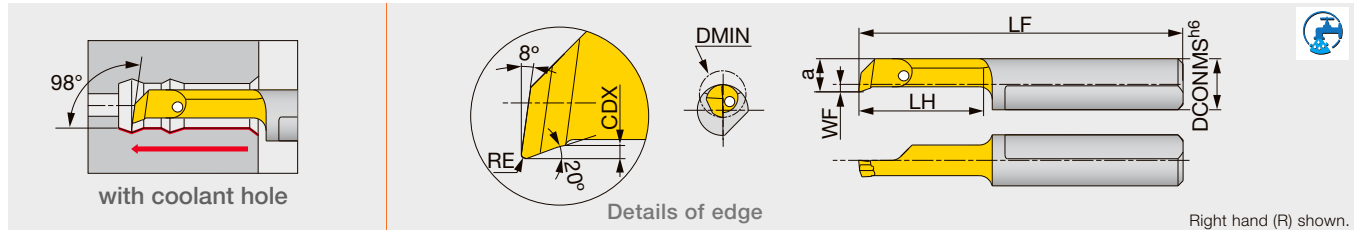

Right hand (R) shown.

Designation	SH725	DMIN	DCONMS	WF	a	LF	LH	CDX	RE ^{+0.05} ₀
JBTR04020004-D006	●	0.6	4	-1.5	0.5	18.5	2	0.08	0.04
JBTR04030004-D006	●	0.6	4	-1.5	0.5	19.5	3	0.08	0.04
JBTR04045005-D010	●	1	4	-1.1	0.9	21	4.5	0.1	0.05
JBTR04065005-D010	●	1	4	-1.1	0.9	23	6.5	0.1	0.05
JBTR04040005-D020	●	2	4	-0.3	1.7	20.5	4	0.1	0.05
JBTR04090005-D020	●	2	4	-0.3	1.7	25.5	9	0.1	0.05
JBTR04140005-D020	●	2	4	-0.3	1.7	30.5	14	0.1	0.05
JBTR/L04090010-D028	●	2.8	4	0.9	2.6	25.5	9	0.2	0.1
JBTR/L04150010-D028	●	2.8	4	0.9	2.6	31.5	15	0.2	0.1
JBTR/L04190010-D028	●	2.8	4	0.9	2.6	35.5	19	0.2	0.1
JBTR/L04090010-D040	●	4	4	1.5	3.5	25.5	9	0.3	0.1
JBTR/L04150010-D040	●	4	4	1.5	3.5	31.5	15	0.3	0.1
JBTR/L04190010-D040	●	4	4	1.5	3.5	35.5	19	0.3	0.1
JBTR04230010-D040	●	4	4	1.5	3.5	39.5	23	0.3	0.1
JBTR04270010-D040	●	4	4	1.5	3.5	43.5	27	0.3	0.1
JBTR/L07090015-D050	●	5	7	0.9	4.4	25	9	0.5	0.15
JBTR/L07140015-D050	●	5	7	0.9	4.4	30	14	0.5	0.15
JBTR/L07190015-D050	●	5	7	0.9	4.4	35	19	0.5	0.15
JBTR/L07240015-D050	●	5	7	0.9	4.4	40	24	0.5	0.15
JBTR07290015-D050	●	5	7	0.9	4.4	45	29	0.5	0.15
JBTR07340015-D050	●	5	7	0.9	4.4	50	34	0.5	0.15
JBTL07340015-D050	●	5	7	0.9	4.4	50	34	0.5	0.15
JBTR/L07140015-D060	●	6	7	1.8	5.3	30	14	0.5	0.15
JBTR/L07210015-D060	●	6	7	1.8	5.3	37	21	0.5	0.15
JBTR/L07240015-D060	●	6	7	1.8	5.3	40	24	0.5	0.15
JBTR/L07290015-D060	●	6	7	1.8	5.3	45	29	0.5	0.15
JBTR07340015-D060	●	6	7	1.8	5.3	50	34	0.5	0.15
JBTR07410015-D060	●	6	7	1.8	5.3	57	41	0.5	0.15
JBTR/L07190015-D068	●	6.8	7	2.8	6.3	35	19	0.6	0.15
JBTR07240015-D068	●	6.8	7	2.8	6.3	40	24	0.6	0.15
JBTR/L07290015-D068	●	6.8	7	2.8	6.3	45	29	0.6	0.15
JBTR/L07340015-D070	●	7	7	2.8	6.3	50	34	0.6	0.15
JBTR07390015-D070	●	7	7	2.8	6.3	55	39	0.6	0.15
JBTR07440015-D070	●	7	7	2.8	6.3	60	44	0.6	0.15
JBTR07490015-D070	●	7	7	2.8	6.3	65	49	0.6	0.15

● : Line up

Grade
Insert
Ext. Toolholder
Int. Toolholder
Threading
Grooving
Shaper
Endmill
Drilling Tool
Technical Reference

Solid boring bar for boring and chamfering

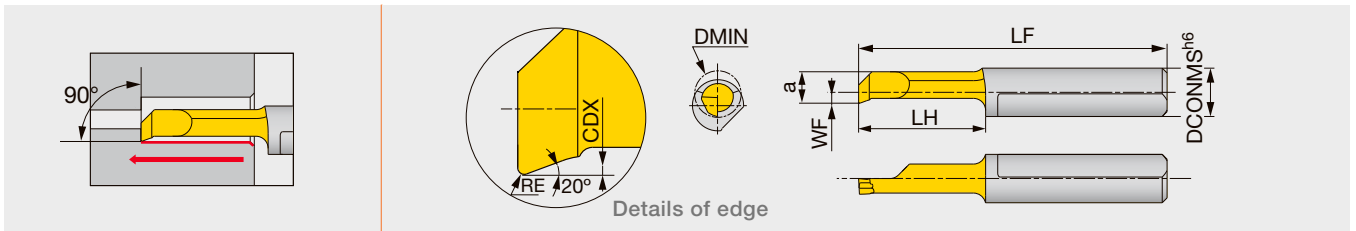

Designation	SH725	DMIN	DCONMS	WF	a	LF	LH	CDX	RE ^{+0.05}
TBPR04090010-D028	●	2.8	4	0.9	2.6	25.5	9	0.2	0.1
TBPR04150010-D040	●	4	4	1.5	3.5	31.5	15	0.3	0.1
TBPR07140015-D050	●	5	7	0.9	4.4	30	14	0.5	0.15
TBPR07190015-D050	●	5	7	0.9	4.4	35	19	0.5	0.15

● : Line up

JBPR

Solid boring bar for boring and chamfering

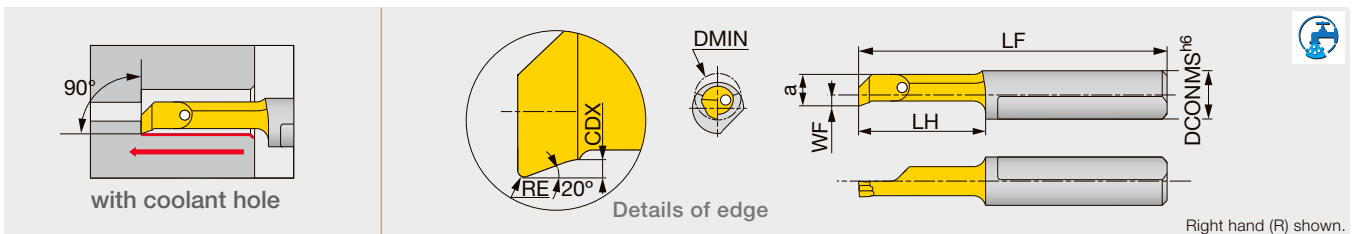

Designation	SH725	DMIN	DCONMS	WF	a	LF	LH	CDX	RE ^{+0.05}
JBPR04090010-D028	●	2.8	4	0.9	2.6	25.5	9	0.2	0.1
JBPR04150010-D028	●	2.8	4	0.9	2.6	31.5	15	0.2	0.1
JBPR04090010-D040	●	4	4	1.5	3.5	25.5	9	0.3	0.1
JBPR04150010-D040	●	4	4	1.5	3.5	31.5	15	0.3	0.1
JBPR07140015-D050	●	5	7	0.9	4.4	30	14	0.5	0.15
JBPR07190015-D050	●	5	7	0.9	4.4	35	19	0.5	0.15

● : Line up

TBUR

Solid boring bar for back boring and chamfering

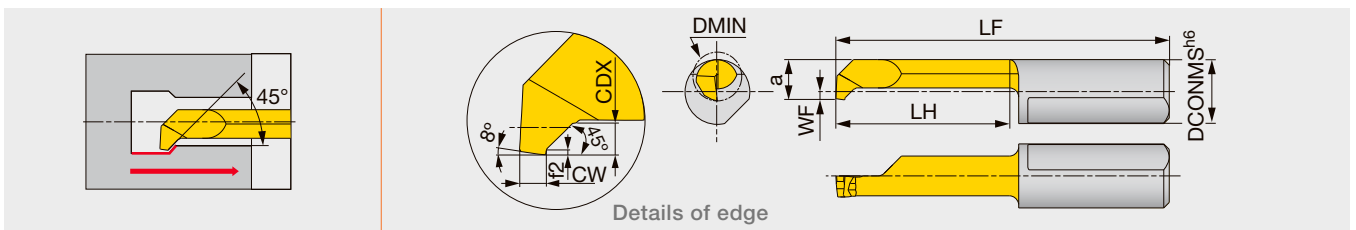

Designation	SH725	DMIN	DCONMS	WF	a	LF	LH	f2	CDX	CW ^{+0.05}
TBUR07140010-D050	●	5	7	0.9	4.4	30	14	0.2	1	1
TBUR07190010-D050	●	5	7	0.9	4.4	35	19	0.2	1	1

● : Line up

JBUR

Solid boring bar for back boring and chamfering

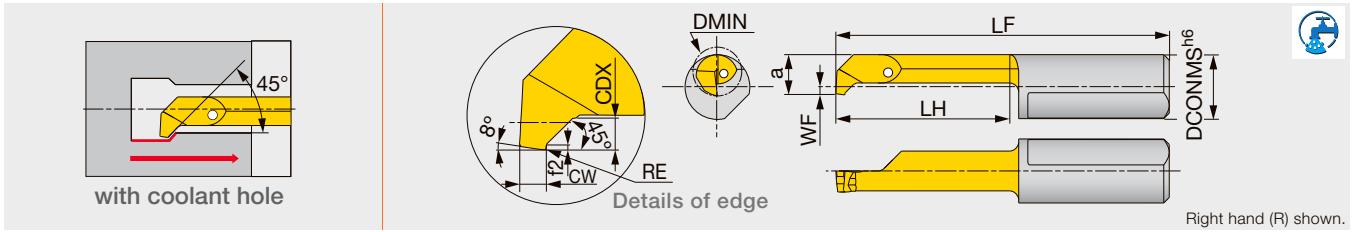

Designation	SH725	DMIN	DCONMS	WF	a	LF	LH	f2	CDX	CW ^{+0.05} ₀	RE
JBUR07140010-D050	●	5	7	0.9	4.4	30	14	0.2	1	1	0.1
JBUR07190010-D050	●	5	7	0.9	4.4	35	19	0.2	1	1	0.1

● : Line up

TBCR

Solid boring bar for boring and 45° chamfering

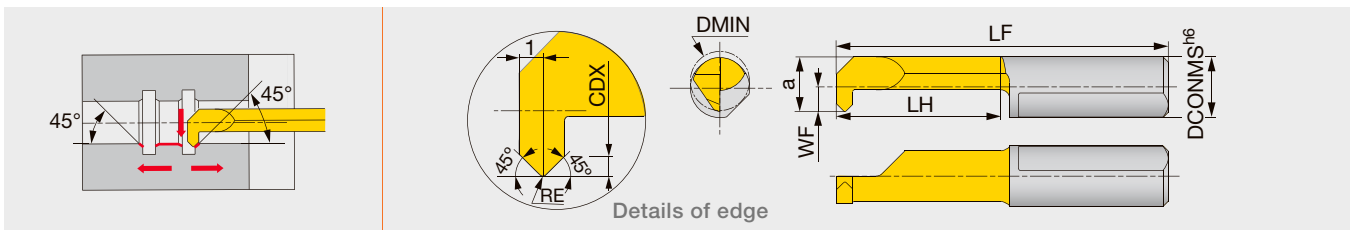

Designation	SH725	DMIN	DCONMS	WF	a	LF	LH	CDX	RE ^{+0.05} ₀
TBCR07140020-D050	●	5	7	0.9	4.4	30	14	0.7	0.2
TBCR07190020-D068	●	6.8	7	2.8	6.3	35	19	0.7	0.2

● : Line up

JBCR

Solid boring bar for boring and 45° chamfering

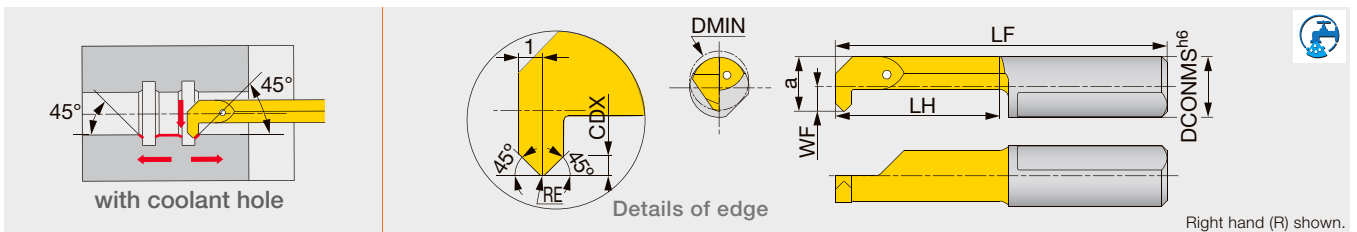

Designation	SH725	DMIN	DCONMS	WF	a	LF	LH	CDX	RE ^{±0.05}
JBCR07140020-D050	●	5	7	0.9	4.4	30	14	0.7	0.2
JBCR07190020-D050	●	5	7	0.9	4.4	35	19	0.7	0.2
JBCR07190020-D068	●	6.8	7	2.8	6.3	35	19	0.7	0.2

● : Line up

Grade
Insert
Ext. Toolholder
Int. Toolholder
Threading
Grooving
Shaper
Endmill
Drilling Tool
Technical Reference

1
2
3
4
5
6
7
8
9
10

Solid boring bar for back boring

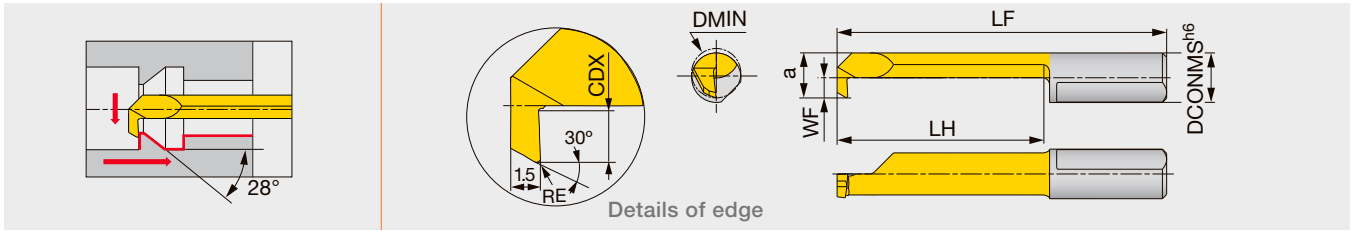

Designation	SH725	DMIN	DCONMS	WF	a	LF	LH	CDX	RE ^{+0.05} ₀
TBBR04140020-D030	●	3	4	0.6	2.6	30	14	0.5	0.2
TBBR04140015-D040	●	4	4	1.5	3.5	30	14	0.8	0.15
TBBR07190020-D050	●	5	7	0.9	4.4	35	19	1	0.2

● : Line up

JBBR

Solid boring bar for back boring

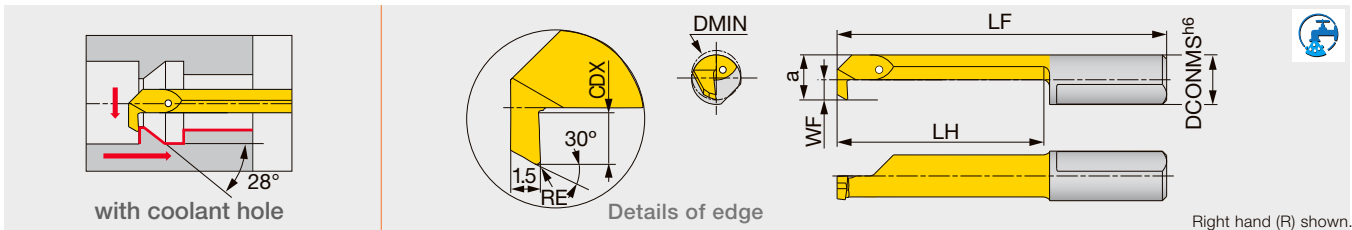

Right hand (R) shown.

Designation	SH725	DMIN	DCONMS	WF	a	LF	LH	CDX	RE ^{+0.05} ₀
JBBR04140020-D030	●	3	4	0.6	2.6	30	14	0.5	0.2
JBBR04190020-D030	●	3	4	0.6	2.6	35	19	0.5	0.2
JBBR04140015-D040	●	4	4	1.5	3.5	30	14	0.8	0.15
JBBR04240015-D040	●	4	4	1.5	3.5	40	24	0.8	0.15
JBBR07190020-D050	●	5	7	0.9	4.4	35	19	1	0.2
JBBR07290020-D050	●	5	7	0.9	4.4	45	29	1	0.2
JBBR07190020-D060	●	6	7	1.8	5.3	35	19	1.8	0.2
JBBR07290020-D060	●	6	7	1.8	5.3	45	29	1.8	0.2
JBBR07190020-D070	●	7	7	2.8	6.3	35	19	2.5	0.2
JBBR07290020-D070	●	7	7	2.8	6.3	45	29	2.5	0.2

● : Line up

TBIR

Solid boring bar for threading (metric)

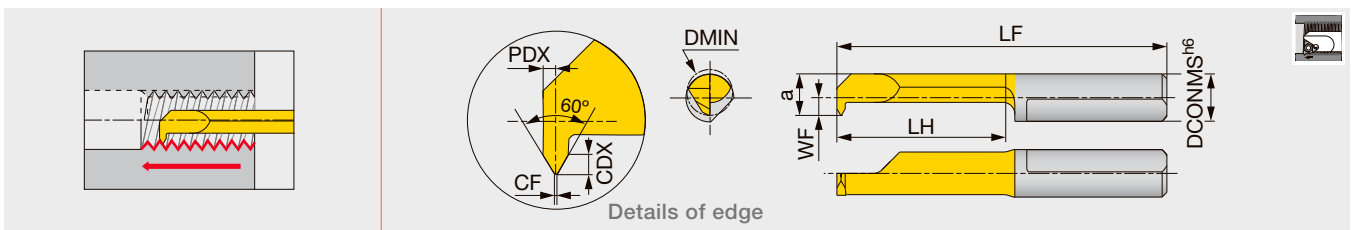

Designation	SH725	Pitch	DMIN	CF ⁰ _{0.02}	DCONMS	WF	a	LF	LH	CDX	PDX
TBIR04140050-D040	●	0.5	4	0.06	4	1.5	3.5	30	14	0.3	0.35
TBIR07140050-D050	●	0.5	5	0.06	7	0.9	4.4	30	14	0.3	0.35
TBIR07140075-D050	●	0.75	5	0.09	7	0.9	4.4	30	14	0.4	0.45
TBIR07140100-D048	●	1	4.8	0.12	7	0.9	4.4	30	14	0.6	0.55
TBIR07140100-D060	●	1	6	0.12	7	1.8	5.3	30	14	0.6	0.55
TBIR07140150-D060	●	1.5	6	0.18	7	1.8	5.3	30	14	0.8	0.75

● : Line up

JBIR

Solid boring bar for threading (metric)

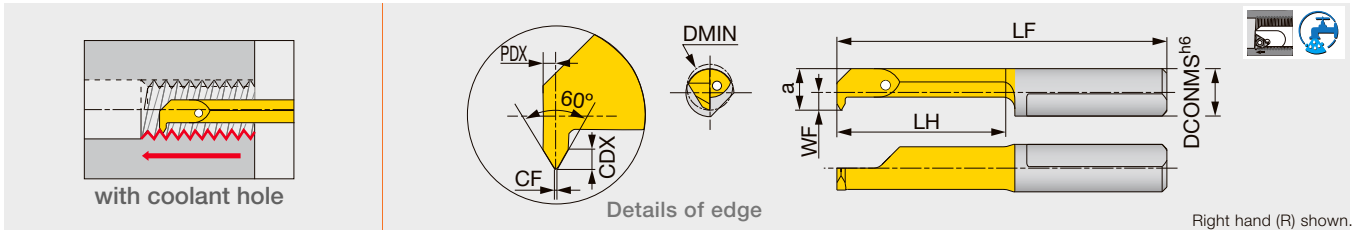

Right hand (R) shown.

Designation	SH725	Pitch	DMIN	CF _{0.02}	DCONMS	WF	a	LF	LH	CDX	PDX
JBIR04140050-D040	●	0.5	4	0.06	4	1.5	3.5	30	14	0.3	0.35
JBIR07140050-D050	●	0.5	5	0.06	7	0.9	4.4	30	14	0.3	0.35
JBIR07140075-D050	●	0.75	5	0.09	7	0.9	4.4	30	14	0.4	0.45
JBIR07140100-D048	●	1	4.8	0.12	7	0.9	4.4	30	14	0.6	0.55
JBIR07140100-D060	●	1	6	0.12	7	1.8	5.3	30	14	0.6	0.55
JBIR07140125-D060	●	1.25	6	0.15	7	1.8	5.3	30	14	0.7	0.65
JBIR07140150-D060	●	1.5	6	0.18	7	1.8	5.3	30	14	0.8	0.75
JBIR07140150-D070	●	1.5	7	0.18	7	2.8	6.3	30	14	0.8	0.75

● : Line up

TBGR

Solid boring bar for internal grooving

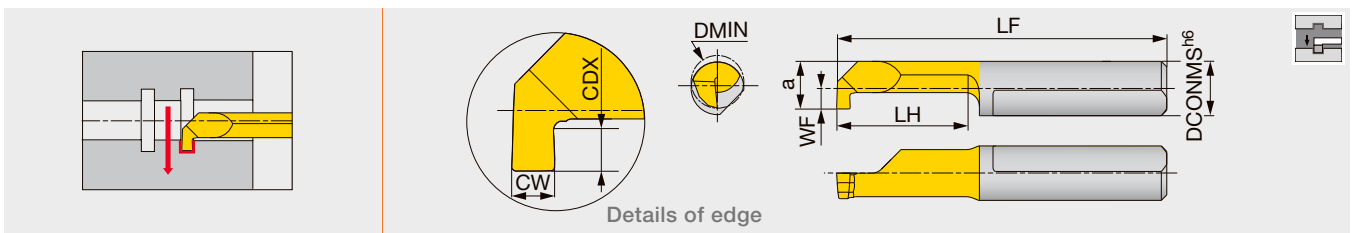

Designation	SH725	CW ₀ ^{+0.05}	DMIN	DCONMS	WF	a	LF	LH	CDX
TBGR04100050-D020	●	0.5	2	4	-0.2	1.8	26	10	0.4
TBGR04090100-D040	●	1	4	4	1.5	3.5	25.5	9	0.8
TBGR04150100-D040	●	1	4	4	1.5	3.5	31.5	15	0.8
TBGR07090200-D050	●	2	5	7	0.9	4.4	25	9	1
TBGR07090100-D060	●	1	6	7	1.8	5.3	25	9	1.8
TBGR07140100-D060	●	1	6	7	1.8	5.3	30	14	1.8
TBGR07090150-D060	●	1.5	6	7	1.8	5.3	25	9	1.8
TBGR07090200-D060	●	2	6	7	1.8	5.3	25	9	1.8
TBGR07140200-D060	●	2	6	7	1.8	5.3	30	14	1.8
TBGR07090100-D068	●	1	6.8	7	2.7	6.2	25	9	2.5
TBGR07090150-D068	●	1.5	6.8	7	2.7	6.2	25	9	2.5
TBGR07140150-D068	●	1.5	6.8	7	2.7	6.2	30	14	2.5
TBGR07090200-D068	●	2	6.8	7	2.7	6.2	25	9	2.5
TBGR07140200-D068	●	2	6.8	7	2.7	6.2	30	14	2.5
TBGR07210200-D068	●	2	6.8	7	2.7	6.2	37	21	2.5
TBGR07290200-D068	●	2	6.8	7	2.7	6.2	45	29	2.5

Corner radius : less than 0.1 mm.

● : Line up

Grade
Insert
Ext. Toolholder
Int. Toolholder
Threading
Grooving
Shaper
Endmill
Drilling Tool
Technical Reference

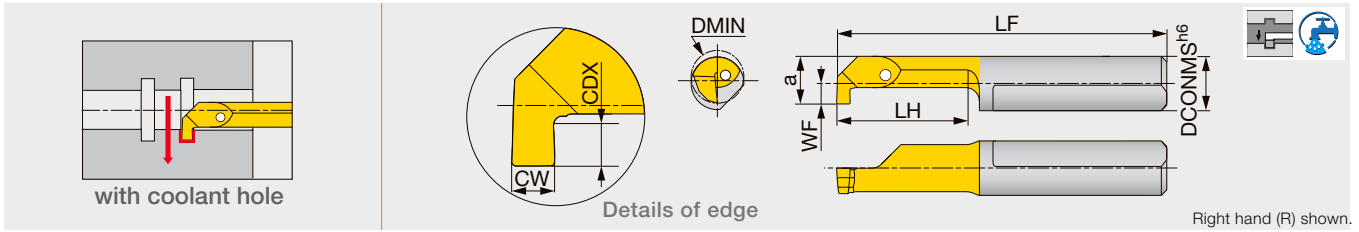

Designation	SH725	CW ^{+0.05} ₀	DMIN	DCONMS	WF	a	LF	LH	CDX
JBGR04050050-D020	●	0.5	2	4	0.2	1.8	21	5	0.4
JBGR04100050-D020	●	0.5	2	4	0.2	1.8	26	10	0.4
JBGR04050070-D030	●	0.7	3	4	0.7	2.7	21	5	0.6
JBGR04100070-D030	●	0.7	3	4	0.7	2.7	26	10	0.6
JBGR04090100-D040	●	1	4	4	1.5	3.5	25.5	9	0.8
JBGR04150100-D040	●	1	4	4	1.5	3.5	31.5	15	0.8
JBGR07090100-D050	●	1	5	7	0.9	4.4	25	9	1
JBGR07140100-D050	●	1	5	7	0.9	4.4	30	14	1
JBGR07090150-D050	●	1.5	5	7	0.9	4.4	25	9	1
JBGR07140150-D050	●	1.5	5	7	0.9	4.4	30	14	1
JBGR07090200-D050	●	2	5	7	0.9	4.4	25	9	1
JBGR07190200-D050	●	2	5	7	0.9	4.4	35	19	1
JBGR/L07090100-D060	●	1	6	7	1.8	5.3	25	9	1.8
JBGR07140100-D060	●	1	6	7	1.8	5.3	30	14	1.8
JBGR07210100-D060	●	1	6	7	1.8	5.3	37	21	1.8
JBGR07290100-D060	●	1	6	7	1.8	5.3	45	29	1.8
JBGR/L07090150-D060	●	1.5	6	7	1.8	5.3	25	9	1.8
JBGR07140150-D060	●	1.5	6	7	1.8	5.3	30	14	1.8
JBGR07210150-D060	●	1.5	6	7	1.8	5.3	37	21	1.8
JBGR07240150-D060	●	1.5	6	7	1.8	5.3	40	24	1.8
JBGR07290150-D060	●	1.5	6	7	1.8	5.3	45	29	1.8
JBGR07090200-D060	●	2	6	7	1.8	5.3	25	9	1.8
JBGR07140200-D060	●	2	6	7	1.8	5.3	30	14	1.8
JBGR07210200-D060	●	2	6	7	1.8	5.3	37	21	1.8
JBGR07240200-D060	●	2	6	7	1.8	5.3	40	24	1.8
JBGR07290200-D060	●	2	6	7	1.8	5.3	45	29	1.8
JBGR07090100-D068	●	1	6.8	7	2.7	6.2	25	9	2.5
JBGR07140100-D068	●	1	6.8	7	2.7	6.2	30	14	2.5
JBGR07210100-D068	●	1	6.8	7	2.7	6.2	37	21	2.5
JBGR07090150-D068	●	1.5	6.8	7	2.7	6.2	25	9	2.5
JBGR07140150-D068	●	1.5	6.8	7	2.7	6.2	30	14	2.5
JBGR07210150-D068	●	1.5	6.8	7	2.7	6.2	37	21	2.5
JBGR07290150-D068	●	1.5	6.8	7	2.7	6.2	45	29	2.5
JBGR07090200-D068	●	2	6.8	7	2.7	6.2	25	9	2.5
JBGR/L07140200-D068	●	2	6.8	7	2.7	6.2	30	14	2.5
JBGR07210200-D068	●	2	6.8	7	2.7	6.2	37	21	2.5
JBGR07250200-D068	●	2	6.8	7	2.7	6.2	40	25	2.5
JBGR07290200-D068	●	2	6.8	7	2.7	6.2	45	29	2.5

Corner radius: less than 0.1 mm

● : Line up

TBFR

Solid boring bar for face grooving

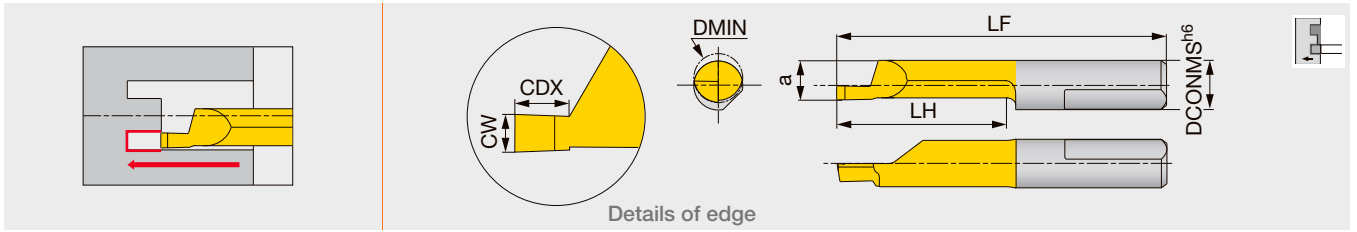

Designation	SH725	$CW^{+0.05}_0$	DMIN	DCONMS	a	LF	LH	CDX
TBFR07110100-D060	●	1	6	7	5.2	26	10	1.5
TBFR07110200-D060	●	2	6	7	5.2	26	10	3
TBFR07110100-D080	●	1	8	7	5.9	27	11	1.5
TBFR07110250-D080	●	2.5	8	7	5.9	27	11	3.5
TBFR07300300-D080	●	3	8	7	5.9	46	30	3.5
TBFR07200250-D150	●	2.5	15	7	5.9	36	20	20
TBFR07200300-D150	●	3	15	7	5.9	36	20	20
TBFR07300300-D150	●	3	15	7	5.9	46	30	30

Corner radius : less than 0.1 mm.

● : Line up

JBFR/L

Solid boring bar for face grooving

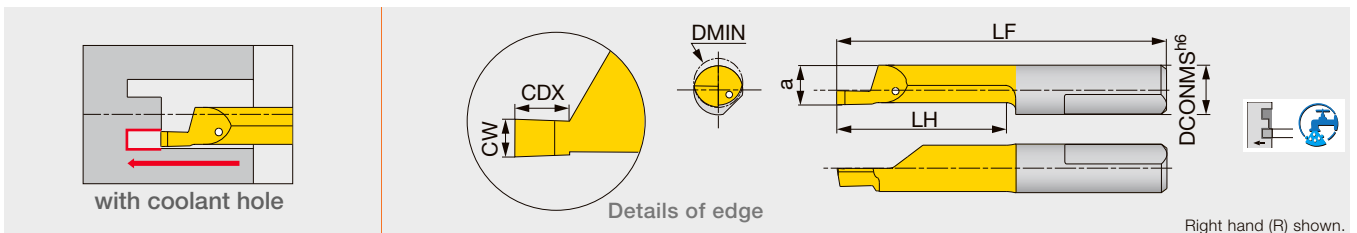

Designation	SH725	$CW^{+0.05}_0$	DMIN	DCONMS	a	LF	LH	CDX
JBFR07110100-D060	●	1	6	7	5.2	26	10	1.5
JBFR07110150-D060	●	1.5	6	7	5.2	26	10	2
JBFR07110200-D060	●	2	6	7	5.2	26	10	3
JBFR07110100-D080	●	1	8	7	5.9	27	11	1.5
JBFR07110150-D080	●	1.5	8	7	5.9	27	11	2.5
JBFR07110200-D080	●	2	8	7	5.9	27	11	3
JBFR07110250-D080	●	2.5	8	7	5.9	27	11	3.5
JBFR07110300-D080	●	3	8	7	5.9	27	11	3.5
JBFR/L07210150-D080	●	1.5	8	7	5.9	36	21	2.5
JBFR07210200-D080	●	2	8	7	5.9	36	21	3
JBFR07210250-D080	●	2.5	8	7	5.9	36	21	3.5
JBFR07210300-D080	●	3	8	7	5.9	36	21	3.5
JBFR/L07300200-D080	●	2	8	7	5.9	46	30	3
JBFR07300300-D080	●	3	8	7	5.9	46	30	3.5
JBFR07200200-D080	●	2	8	7	5.9	36	20	3
JBFR07200250-D150	●	2.5	15	7	5.9	36	20	20
JBFR07200300-D150	●	3	15	7	5.9	36	20	20
JBFR07300300-D150	●	3	15	7	5.9	46	30	30

Corner radius: less than 0.1 mm

● : Line up

Grade
Insert
Ext. Toolholder
Int. Toolholder
Threading
Grooving
Shaper
Endmill
Drilling Tool
Technical Reference

Solid boring bar for face grooving (for shaft)

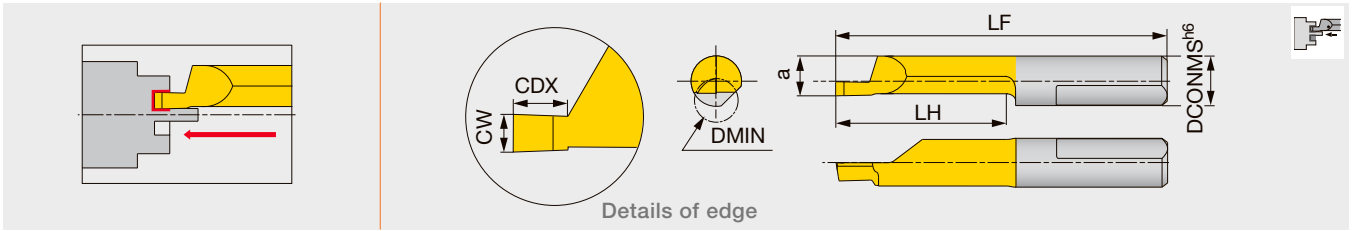

Designation	SH725	$CW^{+0.05}_0$	DMIN	DCONMS	a	LF	LH	CDX
TBSR07200200-D060	●	2	6	7	5.2	36	20	4

Corner radius : less than 0.1 mm.

● : Line up

JBSR

Solid boring bar for face grooving (for shaft)

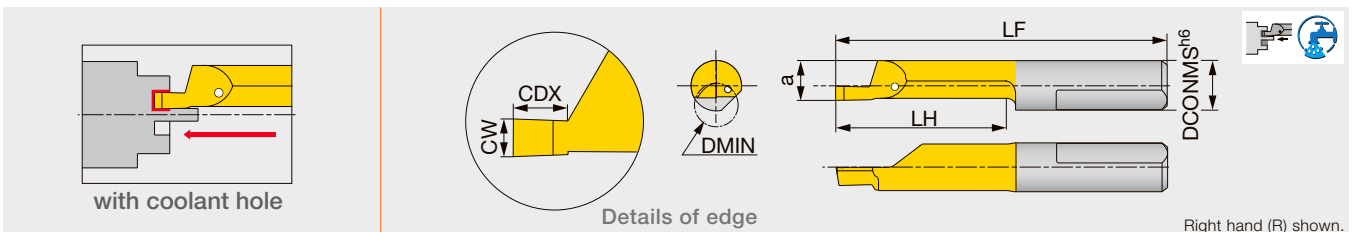

Designation	SH725	$CW^{+0.05}_0$	DMIN	DCONMS	a	LF	LH	CDX
JBSR07200200-D060	●	2	6	7	5.2	36	20	4

Corner radius: less than 0.1 mm

● : Line up

TBRR

Solid boring bar for boring and profiling

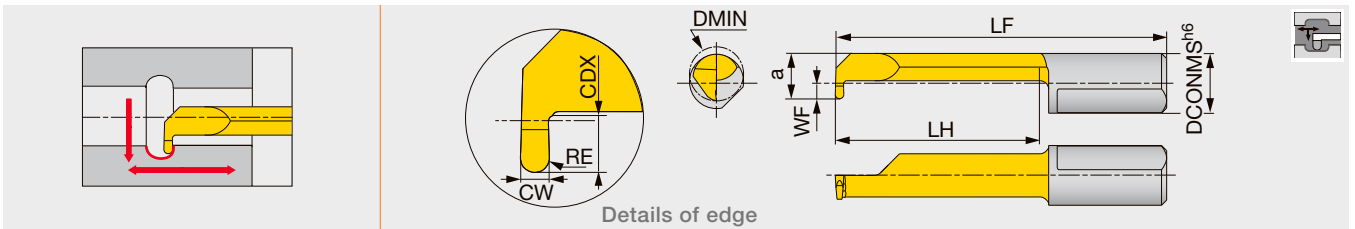

Designation	SH725	$CW^{+0.05}_0$	DMIN	DCONMS	WF	a	LF	LH	CDX	RE
TBRR07190050-D050	●	1	5	7	0.9	4.4	35	19	1	0.5
TBRR07240050-D060	●	1	6	7	1.8	5.3	40	24	1.8	0.5
TBRR07290050-D068	●	1	6.8	7	2.8	6.3	45	29	2.5	0.5

● : Line up

JBRR

Solid boring bar for boring and profiling

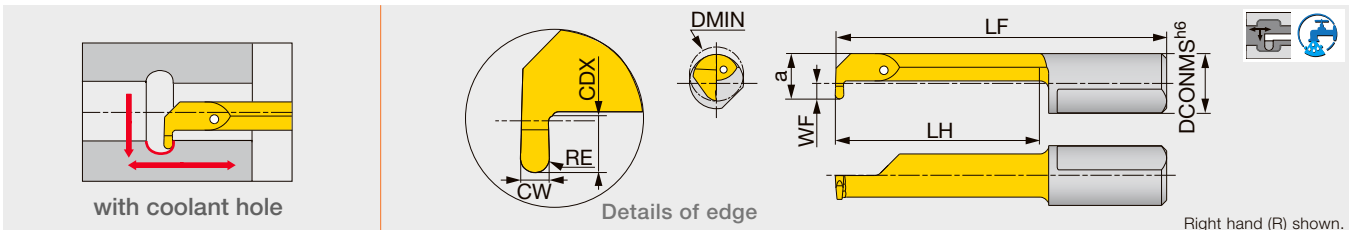

Designation	SH725	$CW^{+0.05}_0$	DMIN	DCONMS	WF	a	LF	LH	CDX	RE
JBRR07190050-D050	●	1	5	7	0.9	4.4	35	19	1	0.5
JBRR07240050-D060	●	1	6	7	1.8	5.3	40	24	1.8	0.5
JBRR07290050-D068	●	1	6.8	7	2.8	6.3	45	29	2.5	0.5

● : Line up

A/E-SEXPR

Screw-on boring bar, for positive 75° rhombic inserts

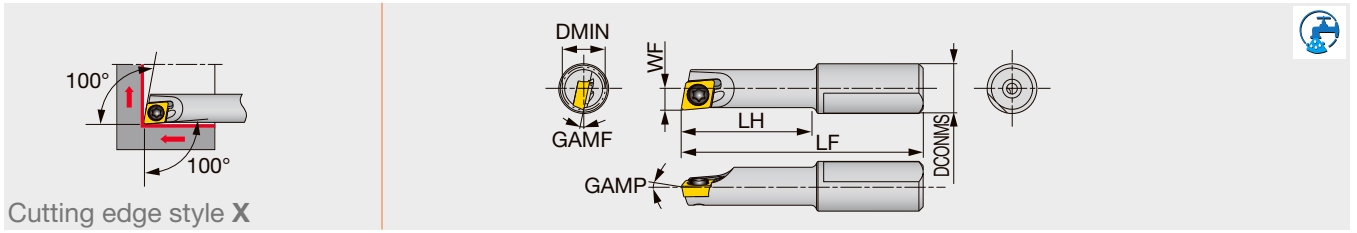

Designation	Material	DMIN	DCONMS	WF	LF	LH	GAMP	GAMF	RE**	Insert	Torque*
A07050-SEXPR03-3	Steel	5	7	2.5	31	15	0°	-13°	0.2	EPGT03X1...	0.6
A07060-SEXPR04-3	Steel	6	7	3.1	34	18	0°	-12°	0.2	EPGT0401...	0.6
E07050-SEXPR03-4	Carbide	5	7	2.5	37	20	0°	-13°	0.2	EPGT03X1...	0.6
E07050-SEXPR03-5	Carbide	5	7	2.5	42	25	0°	-13°	0.2	EPGT03X1...	0.6
E07060-SEXPR04-5	Carbide	6	7	3.1	46	30	0°	-12°	0.2	EPGT0401...	0.6

*Torque: Recommended clamping torque (N·m)

**RE : Standard corner radius

Note: Use right-hand toolholders (SEXPR**) with left-hand inserts (L).

A/E-SEZPR

Screw-on boring bar, for positive 75° rhombic inserts

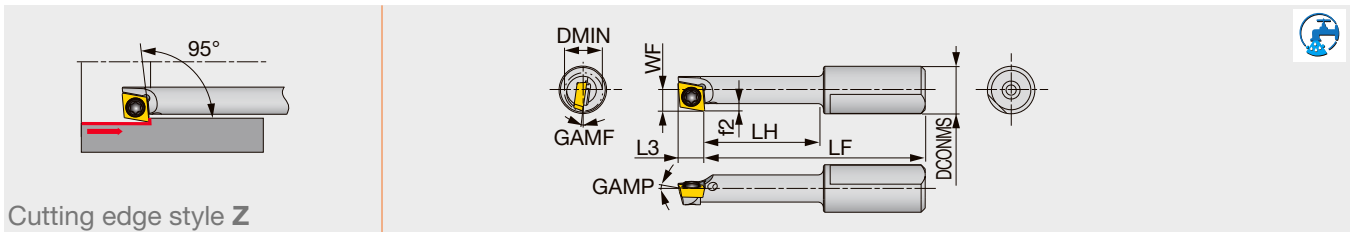

Designation	Material	DMIN	DCONMS	WF	LF	LH	f2	L3	GAMP	GAMF	RE**	Insert	Torque*
A07055-SEZPR03-3	Steel	5.5	7	3.2	32.5	16.5	1.2	3.9	0°	-8°	0.2	EPGT03X1...	0.6
E07055-SEZPR03-5	Carbide	5.5	7	3.2	44.7	27.5	1.2	3.9	0°	-8°	0.2	EPGT03X1...	0.6

*Torque: Recommended clamping torque (N·m)

**RE : Standard corner radius

Note: Use right-hand toolholders (SEZPR**) with right-hand inserts (R).

SPARE PARTS

Designation	Clamping screw	Wrench
A/E070**03-...	CSTA-1.6	T-6F
A/E070**04-...	CSTB-2	T-6F

Sleeve for internal coolant supply with 4 coolant holes

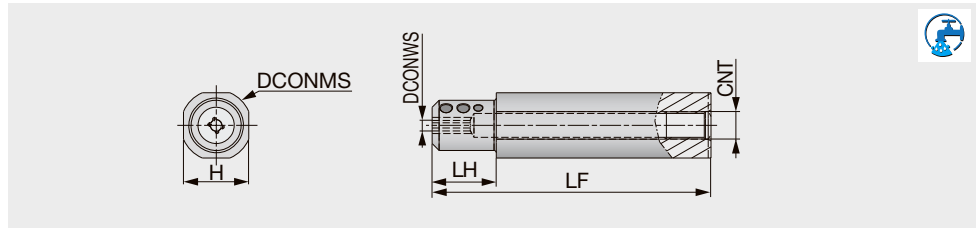

Designation	DCONMS	DCONWS	LF	LH	H	CNT
JBBS12-4-L80C-4N	12	4	80	10	10.3	Rc1/16
JBBS127-4-L80C-4N	12.7	4	80	10	11.6	Rc1/16
JBBS14-4-L80C-4N	14	4	80	10	12	Rc1/8
JBBS159-4-L100C-4N	15.875	4	100	10	14.58	Rc1/8
JBBS159-7-L100C-4N	15.875	7	100	10	14.58	Rc1/8
JBBS16-4-L100C-4N	16	4	100	10	15	Rc1/8
JBBS16-7-L100C-4N	16	7	100	10	15	Rc1/8
JBBS19-4-L100C-4N	19.05	4	100	20	17.2	Rc1/8
JBBS19-7-L100C-4N	19.05	7	100	20	17.2	Rc1/8
JBBS20-4-L100C-4N	20	4	100	20	18	Rc1/8
JBBS20-7-L100C-4N	20	7	100	20	18	Rc1/8
JBBS22-4-L100C-4N	22	4	100	20	20	Rc1/8
JBBS22-7-L100C-4N	22	7	100	20	20	Rc1/8
JBBS25-4-L100C-4N	25	4	100	23	23	Rc1/8
JBBS25-7-L100C-4N	25	7	100	23	23	Rc1/8
JBBS254-4-L100C-4N	25.4	4	100	23	23.4	Rc1/8
JBBS254-7-L100C-4N	25.4	7	100	23	23.4	Rc1/8

JBBS

Sleeve for external coolant supply

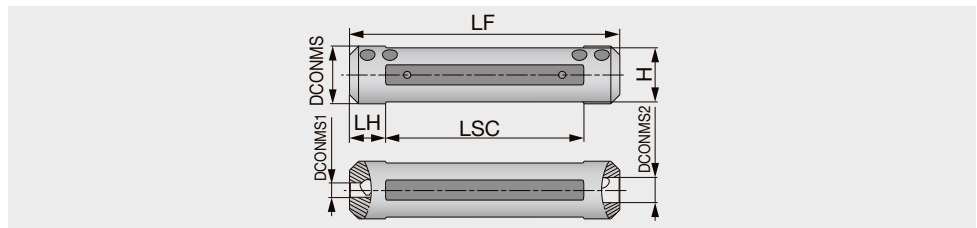

Designation	DCONMS	DCONWS1	DCONWS2	LF	LH	LSC	H
JBBS12-4-4	12	4	4	75	10	55	10.3
JBBS127-4-4	12.7	4	4	76.2	10	56.2	11.6
JBBS14-4-4	14	4	4	75	10	55	12
JBBS159-4-7	15.875	4	7	76.2	10	56.2	14
JBBS16-4-7	16	4	7	75	10	55	15
JBBS19-4-7	19.05	4	7	89	10	69	17.2
JBBS20-4-7	20	4	7	90	10	70	18
JBBS22-4-7	22	4	7	90	10	70	20
JBBS25-4-7	25	4	7	100	10	80	23
JBBS254-4-7	25.4	4	7	90	10	70	23.4

SPARE PARTS



Designation	Clamping screw	Wrench
JBBS**-4-L**C-4N, JBBS127-4-4, JBBS**-4-7	SSHM5-6PF-S	P-2.5
JBBS**-7-L**C-4N, JBBS12-4-4, JBBS14-4-4	SSHM5-4PF-S	P-2.5

JBBS-C

Sleeve for internal coolant supply

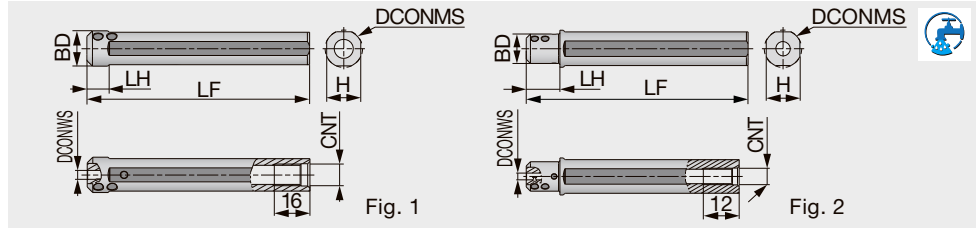

Designation	DCONMS	BD	DCONWS	LF	LH	H	CNT	Fig.
JBBS159-4-L100C	15.875	15.875	4	100	10	14.58	Rc1/8	1
JBBS159-7-L100C	15.875	15.875	7	100	10	14.58	Rc1/8	1
JBBS16-4-L100C	16	16	4	100	10	15	Rc1/8	1
JBBS16-7-L100C	16	16	7	100	10	15	Rc1/8	1
JBBS19-4-L100C	19.05	17.5	4	100	20	17.2	Rc1/8	2
JBBS19-7-L100C	19.05	17.5	7	100	20	17.2	Rc1/8	2
JBBS20-4-L100C	20	17.5	4	100	20	18	Rc1/8	2
JBBS20-7-L100C	20	17.5	7	100	20	18	Rc1/8	2
JBBS22-4-L100C	22	17.5	4	100	20	20	Rc1/8	2
JBBS22-7-L100C	22	17.5	7	100	20	20	Rc1/8	2
JBBS25-4-L100C	25	18	4	100	23	23	Rc1/8	2
JBBS25-7-L100C	25	18	7	100	23	23	Rc1/8	2
JBBS254-4-L100C	25.4	18	4	100	23	23.4	Rc1/8	2
JBBS254-7-L100C	25.4	18	7	100	23	23.4	Rc1/8	2

JBBSA-C

Collet chuck sleeve for solid carbide bars

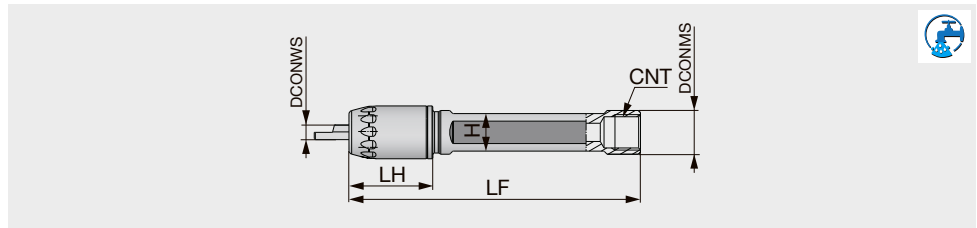

Designation	DCONMS	DCONWS	LF	LH	H	CNT
JBBSA16-4-L100C	16	4	100	23	14	Rc1/8
JBBSA16-7-L100C	16	7	100	23	14	Rc1/8
JBBSA20-4-L120C	20	4	120	23	18	Rc1/8
JBBSA20-7-L120C	20	7	120	23	18	Rc1/8

SPARE PARTS

Designation	Clamping screw	Cap	Wrench	Wrench 1
JBBS**-4-L100C	SSHM5-6PF-S	-	P-2.5	-
JBBS**-7-L100C	SSHM5-4PF-S	-	P-2.5	-
JBBSA**-4-L100C	-	CAP-A-4	-	WRENCH-A-4
JBBSA**-7-L100C	-	CAP-A-7	-	WRENCH-A-7

Grade
1
Insert
2
Ext. Toolholder
3
Int. Toolholder
4
Threading
5
Grooving
6
Shaper
7
Endmill
8
Drilling Tool
9
Technical Reference
10

Boring, profiling, chamfering, back boring

ISO	Workpiece material	Grade	Cutting speed Vc (m/min)	Feed f (mm/rev)
P	Low carbon steels S15C, S25C, etc. C15E, C15E4, etc.	SH730, SH725	40 - 140	0.01 - 0.08
	Carbon steels, Alloy steels S55C, SCM440, etc. C55, 42CrMo4, etc.	SH730, SH725	40 - 140	0.01 - 0.08
	Prehardened steels NAK80, PX5, etc.	SH730, SH725	40 - 140	0.01 - 0.08
M	Stainless steels SUS304, SUS316, etc. X5CrNi18-9, X5CrNiMo17-12-3, etc.	SH730, SH725	40 - 140	0.01 - 0.08
K	Grey cast irons FC250, FCD300, etc. GG25, 250, GG30, 300, etc.	SH730, SH725	30 - 100	0.01 - 0.08
	Ductile cast irons FC450, FCD600, etc. GGG60, 600-3, etc.	SH730, SH725	30 - 100	0.01 - 0.08
N	Aluminium alloys, Copper alloys Si < 12%	SH730, SH725	90 - 200	0.01 - 0.08
S	Titanium alloys Ti-6Al-4V, etc.	SH730, SH725	30 - 100	0.01 - 0.08
	Superalloys Inconel718, etc.	SH730, SH725	30 - 100	0.01 - 0.08

Threading (metric thread)

ISO	Workpiece material	Grade	Cutting speed Vc (m/min)	Number of passes Pitch (mm)				
				0.5	0.75	1	1.25	1.5
P	Low carbon steels S15C, S25C, etc. C15E, C15E4, etc.	SH730, SH725	40 - 140	6 - 8	8 - 10	10 - 12	12 - 15	15 - 18
	Carbon steels, Alloy steels S55C, SCM440, etc. C55, 42CrMo4, etc.	SH730, SH725	40 - 140	6 - 8	8 - 10	10 - 12	12 - 15	15 - 18
	Prehardened steels NAK80, PX5, etc.	SH730, SH725	40 - 140	6 - 8	8 - 10	10 - 12	12 - 15	15 - 18
M	Stainless steels SUS304, SUS316, etc. X5CrNi18-9, X5CrNiMo17-12-3, etc.	SH730, SH725	40 - 140	8	10	12	15	18
K	Grey cast irons FC250, FCD300, etc. GG25, 250, GG30, 300, etc.	SH730, SH725	30 - 100	7	9	12	14	17
	Ductile cast irons FC450, FCD600, etc. GGG60, 600-3, etc.	SH730, SH725	30 - 100	7	9	12	14	17
N	Aluminium alloys, Copper alloys Si < 12%	SH730, SH725	90 - 200	6	8	10	12	15

Internal and face grooving

ISO	Workpiece material	Grade	Cutting speed Vc (m/min)	Feed: f (mm/rev)	
				Internal grooving	Face grooving
P	Low carbon steels S15C, S25C, etc. C15E, C15E4, etc.	SH730, SH725	40 - 140	0.01 - 0.03	0.01 - 0.05
	Carbon steels, Alloy steels S55C, SCM440, etc. C55, 42CrMo4, etc.	SH730, SH725	40 - 140	0.01 - 0.03	0.01 - 0.05
	Prehardened steels NAK80, PX5, etc.	SH730, SH725	40 - 140	0.01 - 0.03	0.01 - 0.05
M	Stainless steels SUS304, SUS316, etc. X5CrNi18-9, X5CrNiMo17-12-3, etc.	SH730, SH725	40 - 140	0.01 - 0.03	0.01 - 0.05
K	Grey cast irons FC250, FCD300, etc. GG25, 250, GG30, 300, etc.	SH730, SH725	30 - 100	0.01 - 0.03	0.01 - 0.05
	Ductile cast irons FC450, FCD600, etc. GGG60, 600-3, etc.	SH730, SH725	30 - 100	0.01 - 0.03	0.01 - 0.05
N	Aluminium alloys, Copper alloys Si < 12%	SH730, SH725	90 - 200	0.01 - 0.03	0.01 - 0.05
S	Titanium alloys Ti-6Al-4V, etc.	SH730, SH725	30 - 100	0.01 - 0.03	0.01 - 0.05
	Superalloys Inconel718, etc.	SH730, SH725	30 - 100	0.01 - 0.03	0.01 - 0.05

HY-NBH-OH

Sleeve for internal coolant supply, with adjustable overhang capability

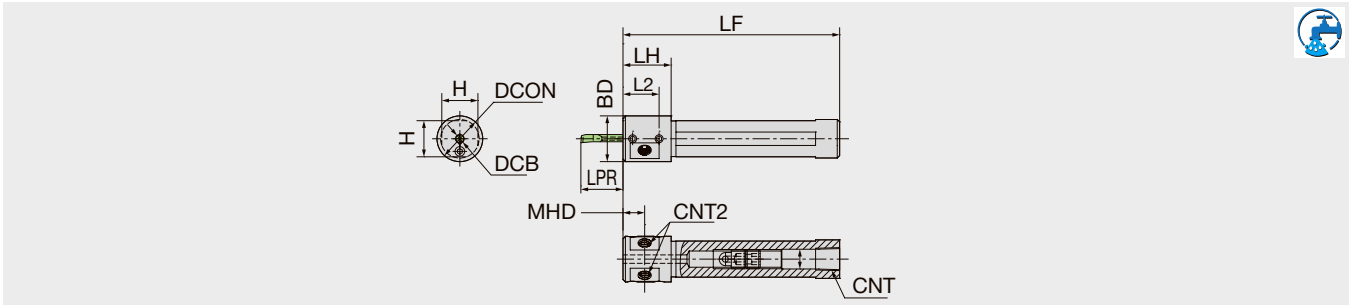

Designation	DCON	DCB	H	BD	LF	LH	LPR	L2	MHD	CNT	CNT2	Applicable Insert bar
HY-NBH02016G-OH	16	2	15	19	90	19	5-18	15	9.5	Rc1/8	M6×P1.0	SB(H)F../SSP..
HY-NBH02516G-OH	16	2.5	15	19	90	19	6.3-19.5	15	9.5	Rc1/8	M6×P1.0	SB(H)F../SB*../SSP..
HY-NBH03016G-OH	16	3	15	19	90	19	7.5-21	15	9.5	Rc1/8	M6×P1.0	SB(H)F../SB*../SSP..
HY-NBH03516G-OH	16	3.5	15	19	90	19	8.8-24.5	15	9.5	Rc1/8	M6×P1.0	SB(H)F../SB*../SSP..
HY-NBH04016G-OH	16	4	15	19	90	24	10-28	20	12	Rc1/8	M6×P1.0	SB(H)F../SB*../SSP..
HY-NBH05016G-OH	16	5	15	19	90	24	12.5 - 35	20	12	Rc1/8	M6×P1.0	SB(H)F../SB*../SSP..

Grade
Insert
Ext. Toolholder
Int. Toolholder
Threading
Grooving
Shaper
Endmill
Drilling Tool
Technical Reference

1
2
3
4
5
6
7
8
9
10

HY-NBH-OH

Sleeve for internal coolant supply, with adjustable overhang capability

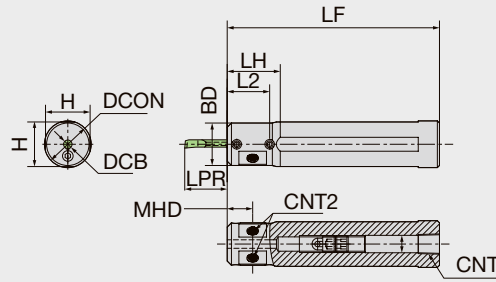

Designation	DCON	DCB	H	BD	LF	LH	LPR	L2	MHD	CNT	CNT2	Applicable Insert bar
HY-NBH02019J-OH	19.05	2	18	19.05	110	-	5-18	15	9.5	Rc1/8	M6xP1.0	SB(H)F./SSP..
HY-NBH02519J-OH	19.05	2.5	18	19.05	110	-	6.3-19.5	15	9.5	Rc1/8	M6xP1.0	SB(H)F./SB*/SSP..
HY-NBH03019J-OH	19.05	3	18	19.05	110	-	7.5-21	15	9.5	Rc1/8	M6xP1.0	SB(H)F./SB*/SSP..
HY-NBH03519J-OH	19.05	3.5	18	19.05	110	-	8.8-24.5	15	9.5	Rc1/8	M6xP1.0	SB(H)F./SB*/SSP..
HY-NBH04019J-OH	19.05	4	18	19.05	110	-	10-28	20	12	Rc1/8	M6xP1.0	SB(H)F./SB*/SSP..
HY-NBH05019J-OH	19.05	5	18	19.05	110	-	12.5 - 35	20	12	Rc1/8	M6xP1.0	SB(H)F./SB*/SSP..
HY-NBH06019J-OH	19.05	6	18	19.05	110	-	15-42	20	12	Rc1/8	M6xP1.0	SB(H)F./SB*/SSP./SFG..
HY-NBH02020J-OH	20	2	19	20	110	-	5-18	15	9.5	Rc1/8	M6xP1.0	SB(H)F./SSP..
HY-NBH02520J-OH	20	2.5	19	20	110	-	6.3-19.5	15	9.5	Rc1/8	M6xP1.0	SB(H)F./SB*/SSP..
HY-NBH03020J-OH	20	3	19	20	110	-	7.5-21	15	9.5	Rc1/8	M6xP1.0	SB(H)F./SB*/SSP..
HY-NBH03520J-OH	20	3.5	19	20	110	-	8.8-24.5	15	9.5	Rc1/8	M6xP1.0	SB(H)F./SB*/SSP..
HY-NBH04020J-OH	20	4	19	20	110	-	10-28	20	12	Rc1/8	M6xP1.0	SB(H)F./SB*/SSP..
HY-NBH05020J-OH	20	5	19	20	110	-	12.5 - 35	20	12	Rc1/8	M6xP1.0	SB(H)F./SB*/SSP..
HY-NBH06020J-OH	20	6	19	20	110	-	15-42	20	12	Rc1/8	M6xP1.0	SB(H)F./SB*/SSP./SFG..
HY-NBH02022X-OH	22	2	21	20	120	25	5-18	15	9.5	Rc1/8	M6xP1.0	SB(H)F./SSP..
HY-NBH02522X-OH	22	2.5	21	20	120	25	6.3-19.5	15	9.5	Rc1/8	M6xP1.0	SB(H)F./SB*/SSP..
HY-NBH03022X-OH	22	3	21	20	120	25	7.5-21	15	9.5	Rc1/8	M6xP1.0	SB(H)F./SB*/SSP..
HY-NBH03522X-OH	22	3.5	21	20	120	25	8.8-24.5	15	9.5	Rc1/8	M6xP1.0	SB(H)F./SB*/SSP..
HY-NBH04022X-OH	22	4	21	20	120	25	10-28	20	12	Rc1/8	M6xP1.0	SB(H)F./SB*/SSP..
HY-NBH05022X-OH	22	5	21	20	120	25	12.5 - 35	20	12	Rc1/8	M6xP1.0	SB(H)F./SB*/SSP..
HY-NBH06022X-OH	22	6	21	20	120	25	15-42	20	12	Rc1/8	M6xP1.0	SB(H)F./SB*/SSP./SFG..
HY-NBH02025.0K-OH	25	2	24	20	125	25	5-18	15	9.5	Rc1/8	M6xP1.0	SB(H)F./SSP..
HY-NBH02525.0K-OH	25	2.5	24	20	125	25	6.3-19.5	15	9.5	Rc1/8	M6xP1.0	SB(H)F./SB*/SSP..
HY-NBH03025.0K-OH	25	3	24	20	125	25	7.5-21	15	9.5	Rc1/8	M6xP1.0	SB(H)F./SB*/SSP..
HY-NBH03525.0K-OH	25	3.5	24	20	125	25	8.8-24.5	15	9.5	Rc1/8	M6xP1.0	SB(H)F./SB*/SSP..
HY-NBH04025.0K-OH	25	4	24	20	125	25	10-28	20	12	Rc1/8	M6xP1.0	SB(H)F./SB*/SSP..
HY-NBH05025.0K-OH	25	5	24	20	125	25	12.5 - 35	20	12	Rc1/8	M6xP1.0	SB(H)F./SB*/SSP..
HY-NBH06025.0K-OH	25	6	24	20	125	25	15-42	20	12	Rc1/8	M6xP1.0	SB(H)F./SB*/SSP./SFG..
HY-NBH02025.4K-OH	25.4	2	24	20	125	25	5-18	15	9.5	Rc1/8	M6xP1.0	SB(H)F./SSP..
HY-NBH02525.4K-OH	25.4	2.5	24	20	125	25	6.3-19.5	15	9.5	Rc1/8	M6xP1.0	SB(H)F./SB*/SSP..
HY-NBH03025.4K-OH	25.4	3	24	20	125	25	7.5-21	15	9.5	Rc1/8	M6xP1.0	SB(H)F./SB*/SSP..
HY-NBH03525.4K-OH	25.4	3.5	24	20	125	25	8.8-24.5	15	9.5	Rc1/8	M6xP1.0	SB(H)F./SB*/SSP..
HY-NBH04025.4K-OH	25.4	4	24	20	125	25	10-28	20	12	Rc1/8	M6xP1.0	SB(H)F./SB*/SSP..
HY-NBH05025.4K-OH	25.4	5	24	20	125	25	12.5 - 35	20	12	Rc1/8	M6xP1.0	SB(H)F./SB*/SSP..
HY-NBH06025.4K-OH	25.4	6	24	20	125	25	15-42	20	12	Rc1/8	M6xP1.0	SB(H)F./SB*/SSP./SFG..

SPARE PARTS



Designation	Clamp screw		Overhang Adjustment			M6 Screw	Wrench		
	①	②	③	④	⑤	⑥	①②	③④⑤	⑥
HY-NBH*-OH	SS04045FS	SS0406F	SS0811R-OH	SS0806F-OH	SS0806F	SS0605SC	LW-2	LW-4*104	LW-3

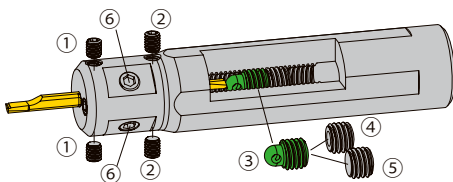

HY-NBH

Sleeve for external coolant supply, with adjustable overhang capability

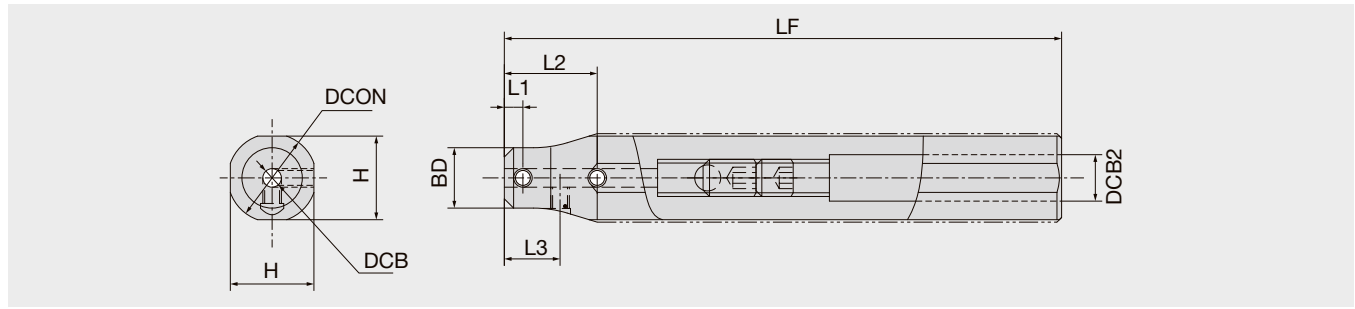

Designation	DCON	DCB	H	BD	LF	DCB2	L1	L2	L3	Applicable Insert bar
HY-NBH02016H	16	2	15	11	100	10	4	15	9.5	SB(H)F../SSP..
HY-NBH02516H	16	2.5	15	11.5	100	10	4	15	9.5	SB(H)F../SB*../SSP..
HY-NBH03016H	16	3	15	12	100	10	4	15	9.5	SB(H)F../SB*../SSP..
HY-NBH03516H	16	3.5	15	12.5	100	10	4	20	12	SB(H)F../SB*../SSP..
HY-NBH04016H	16	4	15	13	100	10	4	20	12	SB(H)F../SB*../SSP..
HY-NBH05016H	16	5	15	14	100	10	4	20	12	SB(H)F../SB*../SSP..
HY-NBH02019K	19.05	2	18	11	125	10	4	15	9.5	SB(H)F../SSP..
HY-NBH02519K	19.05	2.5	18	11.5	125	10	4	15	9.5	SB(H)F../SB*../SSP..
HY-NBH03019K	19.05	3	18	12	125	10	4	15	9.5	SB(H)F../SB*../SSP..
HY-NBH03519K	19.05	3.5	18	12.5	125	10	4	20	12	SB(H)F../SB*../SSP..
HY-NBH04019K	19.05	4	18	13	125	10	4	20	12	SB(H)F../SB*../SSP..
HY-NBH05019K	19.05	5	18	14	125	10	4	20	12	SB(H)F../SB*../SSP..
HY-NBH02020K	20	2	19	11	125	10	4	15	9.5	SB(H)F../SSP..
HY-NBH02520K	20	2.5	19	11.5	125	10	4	15	9.5	SB(H)F../SB*../SSP..
HY-NBH03020K	20	3	19	12	125	10	4	15	9.5	SB(H)F../SB*../SSP..
HY-NBH03520K	20	3.5	19	12.5	125	10	4	20	12	SB(H)F../SB*../SSP..
HY-NBH04020K	20	4	19	13	125	10	4	20	12	SB(H)F../SB*../SSP..
HY-NBH05020K	20	5	19	14	125	10	4	20	12	SB(H)F../SB*../SSP..
HY-NBH02022K	22	2	21	11	125	10	4	15	9.5	SB(H)F../SSP..
HY-NBH02522K	22	2.5	21	11.5	125	10	4	15	9.5	SB(H)F../SB*../SSP..
HY-NBH03022K	22	3	21	12	125	10	4	15	9.5	SB(H)F../SB*../SSP..
HY-NBH03522K	22	3.5	21	12.5	125	10	4	20	12	SB(H)F../SB*../SSP..
HY-NBH04022K	22	4	21	13	125	10	4	20	12	SB(H)F../SB*../SSP..
HY-NBH05022K	22	5	21	14	125	10	4	20	12	SB(H)F../SB*../SSP..
HY-NBH02025K-MET	25	2	24	11	125	10	4	15	9.5	SB(H)F../SSP..
HY-NBH02525K-MET	25	2.5	24	11.5	125	10	4	15	9.5	SB(H)F../SB*../SSP..
HY-NBH03025K-MET	25	3	24	12	125	10	4	15	9.5	SB(H)F../SB*../SSP..
HY-NBH03525K-MET	25	3.5	24	12.5	125	10	4	20	12	SB(H)F../SB*../SSP..
HY-NBH04025K-MET	25	4	24	13	125	10	4	20	12	SB(H)F../SB*../SSP..
HY-NBH05025K-MET	25	5	24	14	125	10	4	20	12	SB(H)F../SB*../SSP..
HY-NBH02025K	25.4	2	24	11	125	10	4	15	9.5	SB(H)F../SSP..
HY-NBH02525K	25.4	2.5	24	11.5	125	10	4	15	9.5	SB(H)F../SB*../SSP..
HY-NBH03025K	25.4	3	24	12	125	10	4	15	9.5	SB(H)F../SB*../SSP..
HY-NBH03525K	25.4	3.5	24	12.5	125	10	4	20	12	SB(H)F../SB*../SSP..
HY-NBH04025K	25.4	4	24	13	125	10	4	20	12	SB(H)F../SB*../SSP..
HY-NBH05025K	25.4	5	24	14	125	10	4	20	12	SB(H)F../SB*../SSP..

SPARE PARTS



Designation	Clamp screw			Overhang Adjustment		Wrench	
	①	②	③	④	⑤	①②③	④⑤
HY-NBH**	SS04045FS	SS0406F	SS0404F	SS0812R	SS0808F	LW-2	LW-4*104

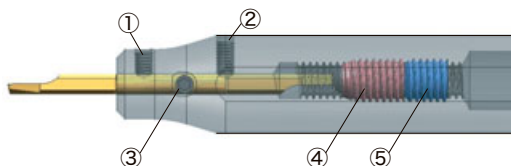

Grade
Insert
Ext. Toolholder
Int. Toolholder
Threading
Grooving
Shaper
Endmill
Drilling Tool
Technical Reference



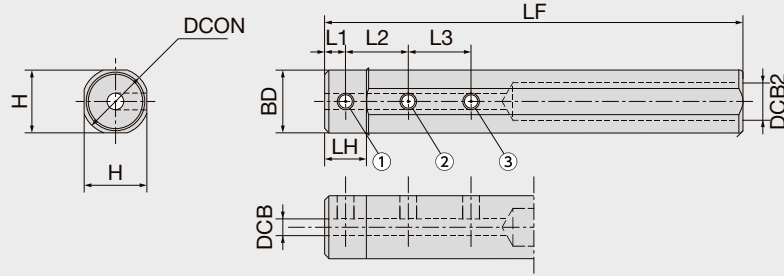

Designation	DCON	DCB	H	BD	LF	LH	DCB2	L1	L2	L3	Insert
NBH02015H	15.875	2	15	15	100	10	9	5	10	-	SB(H)F./SSP..
NBH02515H	15.875	2.5	15	15	100	10	9	5	10	-	SB(H)F./SB*./SSP..
NBH03015H	15.875	3	15	15	100	10	9	5	10	10	SB(H)F./SB*./SSP..
NBH03515H	15.875	3.5	15	15	100	10	9	5	10	10	SB(H)F./SB*./SSP..
NBH04015H	15.875	4	15	15	100	10	9	5	15	15	SB(H)F./SB*./SSP..
NBH04515H	15.875	4.5	15	15	100	10	9	5	15	15	-
NBH05015H	15.875	5	15	15	100	10	9	5	15	15	SB(H)F./SB*./SSP..
NBH06015H	15.875	6	15	15	100	10	9	5	20	20	SB(H)F./SB*./SSP../SFG..
NBH08015H	15.875	8	15	15	100	10	9	5	20	20	SB(H)F./SB*./SSP../SFG..
NBH02016H	16	2	15	15	100	10	9	5	10	-	SB(H)F./SSP..
NBH02516H	16	2.5	15	15	100	10	9	5	10	-	SB(H)F./SB*./SSP..
NBH03016H	16	3	15	15	100	10	9	5	10	10	SB(H)F./SB*./SSP..
NBH03516H	16	3.5	15	15	100	10	9	5	10	10	SB(H)F./SB*./SSP..
NBH04016H	16	4	15	15	100	10	9	5	15	15	SB(H)F./SB*./SSP..
NBH04516H	16	4.5	15	15	100	10	9	5	15	15	-
NBH05016H	16	5	15	15	100	10	9	5	15	15	SB(H)F./SB*./SSP..
NBH06016H	16	6	15	15	100	10	9	5	20	20	SB(H)F./SB*./SSP../SFG..
NBH07016H	16	7	15	15	100	10	9	5	20	20	SB(H)F./SB*..
NBH08016H	16	8	15	15	100	10	9	5	20	20	SB(H)F./SB*./SSP../SFG..
NBH02019K	19.05	2	18	18	125	10	11	5	10	-	SB(H)F./SSP..
NBH02519K	19.05	2.5	18	18	125	10	11	5	10	-	SB(H)F./SB*./SSP..
NBH03019K	19.05	3	18	18	125	10	11	5	10	10	SB(H)F./SB*./SSP..
NBH03519K	19.05	3.5	18	18	125	10	11	5	10	10	SB(H)F./SB*./SSP..
NBH04019K	19.05	4	18	18	125	10	11	5	15	15	SB(H)F./SB*./SSP..
NBH04519K	19.05	4.5	18	18	125	10	11	5	15	15	-
NBH05019K	19.05	5	18	18	125	10	11	5	15	15	SB(H)F./SB*./SSP..
NBH06019K	19.05	6	18	18	125	10	11	5	20	20	SB(H)F./SB*./SSP../SFG..
NBH07019K	19.05	7	18	18	125	10	11	5	20	20	SB(H)F./SB*..
NBH08019K	19.05	8	18	18	125	10	11	5	20	20	SB(H)F./SB*./SSP../SFG..
NBH10019K	19.05	10	18	18	125	10	11	5	20	20	-

SPARE PARTS



Designation	Clamp screw			Wrench (for Clamp screw) ①②
	①	②	③	
NBH02015H	SS0406F	SS0406F	-	LW-2
NBH02515H	SS0406F	SS0406F	-	LW-2
NBH03015H	SS0404F	SS0404F	SS0404F	LW-2
NBH03515H	SS0404F	SS0404F	SS0404F	LW-2
NBH04015H	SS0404F	SS0404F	SS0404F	LW-2
NBH04515H	SS0404F	SS0404F	SS0404F	LW-2
NBH05015H	SS0404F	SS0404F	SS0404F	LW-2
NBH06015H	SS0404F	SS0404F	SS0404F	LW-2
NBH08015H	SS0403F	SS0403F	SS0403F	LW-2
NBH02016H	SS0406F	SS0406F	-	LW-2
NBH02516H	SS0406F	SS0406F	-	LW-2
NBH03016H	SS0404F	SS0404F	SS0404F	LW-2
NBH03516H	SS0404F	SS0404F	SS0404F	LW-2
NBH04016H	SS0404F	SS0404F	SS0404F	LW-2
NBH04516H	SS0404F	SS0404F	SS0404F	LW-2
NBH05016H	SS0404F	SS0404F	SS0404F	LW-2
NBH06016H	SS0404F	SS0404F	SS0404F	LW-2
NBH07016H	SS0403F	SS0404F	SS0404F	LW-2
NBH08016H	SS0403F	SS0403F	SS0403F	LW-2
NBH02019K	SS0408F	SS0408F	-	LW-2
NBH02519K	SS0408F	SS0408F	-	LW-2
NBH03019K	SS0406F	SS0406F	SS0406F	LW-2
NBH03519K	SS0406F	SS0406F	SS0406F	LW-2
NBH04019K	SS0406F	SS0406F	SS0406F	LW-2
NBH04519K	SS0406F	SS0406F	SS0406F	LW-2
NBH05019K	SS0406F	SS0406F	SS0406F	LW-2
NBH06019K	SS0406F	SS0406F	SS0406F	LW-2
NBH07019K	SS0404F	SS0404F	SS0404F	LW-2
NBH08019K	SS0404F	SS0404F	SS0404F	LW-2
NBH10019K	SS0403F	SS0404F	SS0404F	LW-2

Grade



Insert



Ext. Toolholder



Int. Toolholder



Threading



Grooving



Shaper



Endmill



Drilling Tool



Technical Reference



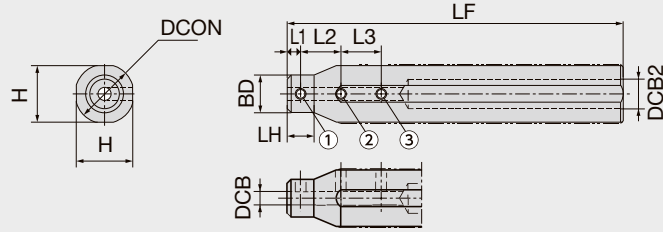

Designation	DCON	DCB	H	BD	LF	LH	DCB2	L1	L2	L3	Insert
NBH02020K	20	2	19	11	125	10	11	5	10	-	SB(H)F./SSP..
NBH02520K	20	2.5	19	11	125	10	11	5	10	-	SB(H)F./SB*./SSP..
NBH03020K	20	3	19	12	125	10	11	5	10	10	SB(H)F./SB*./SSP..
NBH03520K	20	3.5	19	12	125	10	11	5	10	10	SB(H)F./SB*./SSP..
NBH04020K	20	4	19	13	125	10	11	5	15	15	SB(H)F./SB*./SSP..
NBH04520K	20	4.5	19	13	125	10	11	5	15	15	-
NBH05020K	20	5	19	14	125	10	11	5	15	15	SB(H)F./SB*./SSP..
NBH06020K	20	6	19	15	125	10	11	5	20	20	SB(H)F./SB*./SSP./SFG..
NBH07020K	20	7	19	16	125	10	11	5	20	20	SB(H)F./SB*..
NBH08020K	20	8	19	17	125	10	11	5	20	20	SB(H)F./SBG../SSP./SFG..
NBH10020K	20	10	19	19	125	10	11	5	20	20	-
NBH12020K	20	12	19	19	125	10	14	5	25	25	-
NBH02022K	22	2	21	11	125	10	11	5	10	-	SB(H)F./SSP..
NBH02522K	22	2.5	21	11	125	10	11	5	10	-	SB(H)F./SB*./SSP..
NBH03022K	22	3	21	12	125	10	11	5	10	10	SB(H)F./SB*./SSP..
NBH03522K	22	3.5	21	12	125	10	11	5	10	10	SB(H)F./SB*./SSP..
NBH04022K	22	4	21	13	125	10	11	5	15	15	SB(H)F./SB*./SSP..
NBH04522K	22	4.5	21	13	125	10	11	5	15	15	-
NBH05022K	22	5	21	14	125	10	11	5	15	15	SB(H)F./SB*./SSP..
NBH06022K	22	6	21	15	125	10	11	5	20	20	SB(H)F./SB*./SSP./SFG..
NBH07022K	22	7	21	16	125	10	11	5	20	20	SB(H)F./SB*..
NBH08022K	22	8	21	17	125	10	11	5	20	20	SB(H)F./SBG../SSP./SFG..
NBH10022K	22	10	21	19	125	10	11	5	20	20	-
NBH12022K	22	12	21	21	125	10	14	5	25	25	-
NBH02023K	23	2	21	11	125	10	11	5	10	-	SB(H)F./SSP..
NBH02523K	23	2.5	21	11	125	10	11	5	10	-	SB(H)F./SB*./SSP..
NBH03023K	23	3	21	12	125	10	11	5	10	10	SB(H)F./SB*./SSP..
NBH03523K	23	3.5	21	12	125	10	11	5	10	10	SB(H)F./SB*./SSP..
NBH04023K	23	4	21	13	125	10	11	5	15	15	SB(H)F./SB*./SSP..
NBH04523K	23	4.5	21	13	125	10	11	5	15	15	-
NBH05023K	23	5	21	14	125	10	11	5	15	15	SB(H)F./SB*./SSP..
NBH06023K	23	6	21	15	125	10	11	5	20	20	SB(H)F./SB*./SSP./SFG..
NBH08023K	23	8	21	17	125	10	11	5	20	20	SB(H)F./SBG../SSP./SFG..
NBH10023K	23	10	21	19	125	10	11	5	20	20	-
NBH12023K	23	12	21	21	125	10	14	5	25	25	-
NBH02025K-MET	25	2	24	11	125	10	11	5	10	-	SB(H)F./SSP..
NBH02525K-MET	25	2.5	24	11	125	10	11	5	10	-	SB(H)F./SB*./SSP..
NBH03025K-MET	25	3	24	12	125	10	11	5	10	10	SB(H)F./SB*./SSP..
NBH03525K-MET	25	3.5	24	12	125	10	11	5	10	10	SB(H)F./SB*./SSP..
NBH04025K-MET	25	4	24	13	125	10	11	5	15	15	SB(H)F./SB*./SSP..
NBH04525K-MET	25	4.5	24	13	125	10	11	5	15	15	-
NBH05025K-MET	25	5	24	14	125	10	11	5	15	15	SB(H)F./SB*./SSP..
NBH06025K-MET	25	6	24	15	125	10	11	5	20	20	SB(H)F./SB*./SSP./SFG..
NBH07025K-MET	25	7	24	16	125	10	11	5	20	20	SB(H)F./SB*..
NBH08025K-MET	25	8	24	17	125	10	11	5	20	20	SB(H)F./SBG../SSP./SFG..
NBH10025K-MET	25	10	24	19	125	10	11	5	20	20	-
NBH12025K-MET	25	12	24	21	125	10	14	5	25	25	-
NBH02025K	25.4	2	24	11	125	10	11	5	10	-	SB(H)F./SSP..
NBH02525K	25.4	2.5	24	11	125	10	11	5	10	-	SB(H)F./SB*./SSP..
NBH03025K	25.4	3	24	12	125	10	11	5	10	10	SB(H)F./SB*./SSP..
NBH03525K	25.4	3.5	24	12	125	10	11	5	10	10	SB(H)F./SB*./SSP..
NBH04025K	25.4	4	24	13	125	10	11	5	15	15	SB(H)F./SB*./SSP..
NBH04525K	25.4	4.5	24	13	125	10	11	5	15	15	-
NBH05025K	25.4	5	24	14	125	10	11	5	15	15	SB(H)F./SB*./SSP..
NBH06025K	25.4	6	24	15	125	10	11	5	20	20	SB(H)F./SB*./SSP./SFG..
NBH07025K	25.4	7	24	16	125	10	11	5	20	20	SB(H)F./SB*..
NBH08025K	25.4	8	24	17	125	10	11	5	20	20	SB(H)F./SBG../SSP./SFG..
NBH10025K	25.4	10	24	19	125	10	11	5	20	20	-
NBH12025K	25.4	12	24	21	125	10	14	5	25	25	-

Designation	H	BD	LF	LH	DCB	DCB2	DCON	L1	L2	L3	Insert
NBH04532K	30	13	125	10	4.5	11	32	5	15	15	-
NBH05032K	30	14	125	10	5	11	32	5	15	15	SB(H)F../SB*../SSP.
NBH06032K	30	15	125	10	6	11	32	5	20	20	SB(H)F../SB*../SSP../SFG..
NBH07032K	30	16	125	10	7	11	32	5	20	20	SB(H)F..
NBH08032K	30	17	125	10	8	11	32	5	20	20	SB(H)F../SBG../SSP../SFG..
NBH10032K	30	19	125	10	10	11	32	5	20	20	-
NBH12032K	30	21	125	10	12	14	32	5	25	25	-
NBH14032K	30	23	125	10	14	16	32	5	25	25	-
NBH16032K	30	25	125	10	16	18	32	5	25	25	-

SPARE PARTS



Designation	Clamp screw			Wrench (for Clamp screw)
	①	②	③	①②
NBH02020K	SS0404F	SS0404F	-	LW-2
NBH02520K	SS0404F	SS0404F	-	LW-2
NBH03020K	SS0404F	SS0404F	SS0406F	LW-2
NBH03520K	SS0404F	SS0404F	SS0406F	LW-2
NBH04020K	SS0404F	SS0406F	SS0406F	LW-2
NBH04520K	SS0404F	SS0406F	SS0406F	LW-2
NBH05020K	SS0404F	SS0406F	SS0406F	LW-2
NBH06020K	SS0404F	SS0406F	SS0406F	LW-2
NBH07020K	SS0404F	SS0406F	SS0406F	LW-2
NBH08020K	SS0404F	SS0404F	SS0404F	LW-2
NBH10020K	SS0404F	SS0404F	SS0404F	LW-2
NBH12020K	SS0403F	SS0403F	SS0403F	LW-2
NBH02022K	SS0404F	SS0406F	-	LW-2
NBH02522K	SS0404F	SS0406F	-	LW-2
NBH03022K	SS0404F	SS0406F	SS0408F	LW-2
NBH03522K	SS0404F	SS0406F	SS0406F	LW-2
NBH04022K	SS0404F	SS0406F	SS0406F	LW-2
NBH04522K	SS0404F	SS0406F	SS0406F	LW-2
NBH05022K	SS0404F	SS0406F	SS0406F	LW-2
NBH06022K	SS0404F	SS0406F	SS0406F	LW-2
NBH07022K	SS0404F	SS0406F	SS0406F	LW-2
NBH08022K	SS0404F	SS0406F	SS0406F	LW-2
NBH10022K	SS0404F	SS0404F	SS0404F	LW-2
NBH12022K	SS0404F	SS0404F	SS0404F	LW-2
NBH02023K	SS0404F	SS0406F	-	LW-2
NBH02523K	SS0404F	SS0406F	-	LW-2
NBH03023K	SS0404F	SS0406F	SS0408F	LW-2
NBH03523K	SS0404F	SS0406F	SS0406F	LW-2
NBH04023K	SS0404F	SS0406F	SS0406F	LW-2
NBH04523K	SS0404F	SS0406F	SS0406F	LW-2
NBH05023K	SS0404F	SS0406F	SS0406F	LW-2
NBH06023K	SS0404F	SS0406F	SS0406F	LW-2
NBH08023K	SS0404F	SS0406F	SS0406F	LW-2
NBH10023K	SS0404F	SS0404F	SS0404F	LW-2
NBH12023K	SS0404F	SS0404F	SS0404F	LW-2
NBH02025K**	SS0404F	SS0406F	-	LW-2
NBH02525K**	SS0404F	SS0406F	-	LW-2
NBH03025K**	SS0404F	SS0406F	SS0408F	LW-2
NBH03525K**	SS0404F	SS0406F	SS0408F	LW-2
NBH04025K**	SS0404F	SS0408F	SS0408F	LW-2
NBH04525K**	SS0404F	SS0408F	SS0408F	LW-2
NBH05025K**	SS0404F	SS0408F	SS0408F	LW-2
NBH06025K**	SS0404F	SS0408F	SS0408F	LW-2
NBH07025K**	SS0404F	SS0408F	SS0408F	LW-2
NBH08025K**	SS0404F	SS0406F	SS0406F	LW-2
NBH10025K**	SS0404F	SS0406F	SS0406F	LW-2
NBH12025K**	SS0404F	SS0404F	SS0404F	LW-2
NBH04532K	SS0404F	SS0408F	SS0408F	LW-2
NBH05032K	SS0404F	SS0408F	SS0408F	LW-2
NBH06032K	SS0404F	SS0408F	SS0408F	LW-2
NBH07032K	SS0404F	SS0408F	SS0408F	LW-2
NBH08032K	SS0404F	SS0408F	SS0408F	LW-2
NBH10032K	SS0404F	SS0408F	SS0408F	LW-2
NBH12032K	SS0404F	SS0406F	SS0406F	LW-2
NBH14032K	SS0504	SS0506	SS0506	LW-2
NBH16032K	SS0504	SS0506	SS0506	LW-2

Grade
Insert
Ext. Toolholder
Int. Toolholder
Threading
Grooving
Shaper
Endmill
Drilling Tool
Technical Reference



STICK DUO

INSERT BAR

SBFS-S with chipbreaker

Sharp cutting edge

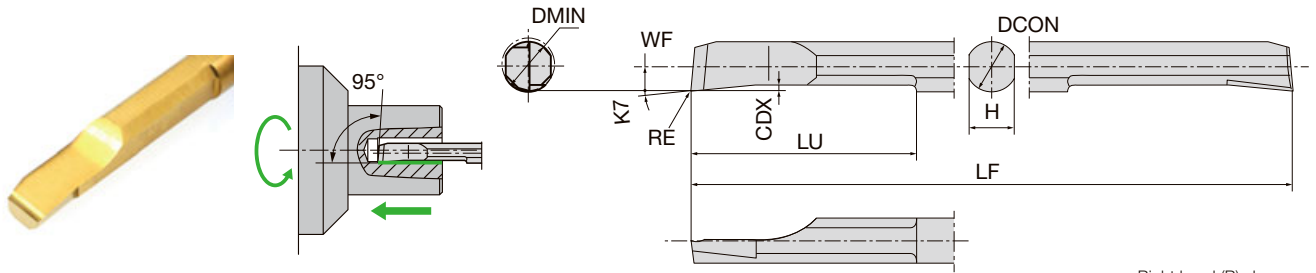

P	Steel	☆	★
M	Stainless	★	☆
N	Non-ferrous	☆	★
S	Superalloys	★	☆
H	Hard materials	☆	★

★ : First choice
☆ : Second choice

Designation	HAND	RE	Coated		DMIN	DCON	H	LF	CDX	LU	WF	K7
			DT4	ZM3								
SBFS020R005S	R	0.05	●	●	2.2	2	1.8	50	0.25	10	0.9	5°
SBFS025R005S	R	0.05	●	●	2.7	2.5	2.3	50	0.3	12.5	1.15	5°
SBFS025R015S	R	0.15	●	●	2.7	2.5	2.3	50	0.3	12.5	1.15	5°
SBFS030R005S	R	0.05	●	●	3.2	3	2.7	50	0.4	15	1.4	5°
SBFS030R015S	R	0.15	●	●	3.2	3	2.7	50	0.4	15	1.4	5°
SBFS035R005S	R	0.05	●	●	3.7	3.5	3.2	60	0.4	17.5	1.65	5°
SBFS035R015S	R	0.15	●	●	3.7	3.5	3.2	60	0.4	17.5	1.65	5°
SBFS040R005S	R	0.05	●	●	4.2	4	3.6	60	0.45	20	1.9	5°
SBFS040R015S	R	0.15	●	●	4.2	4	3.6	60	0.45	20	1.9	5°
SBFS050R005S	R	0.05	●	●	5.2	5	4.5	70	0.5	25	2.4	5°
SBFS050R015S	R	0.15	●	●	5.2	5	4.5	70	0.5	25	2.4	5°
SBFS060R005S	R	0.05	●	●	6.2	6	5.4	80	0.6	30	2.9	5°
SBFS060R015S	R	0.15	●	●	6.2	6	5.4	80	0.6	30	2.9	5°

● : Line up

SBFB-F with chipbreaker

Evacuates chips BACKWARD

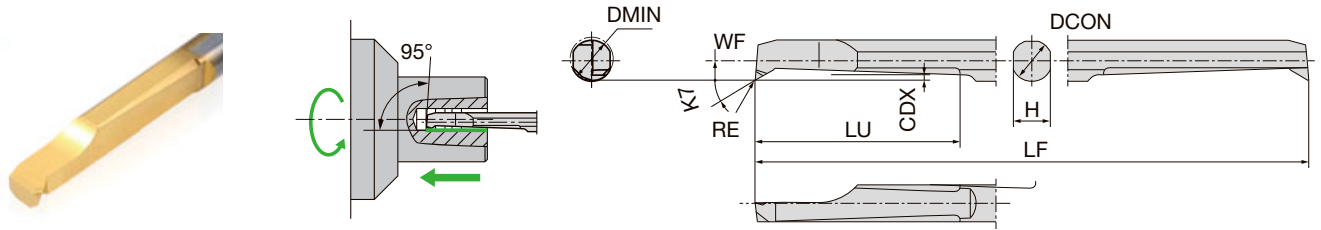

Right hand (R) shown.

P	Steel	☆	★
M	Stainless	★	☆
N	Non-ferrous	☆	★
S	Superalloys	★	☆
H	Hard materials	☆	★

★ : First choice
☆ : Second choice

Designation	HAND	RE	Coated		DMIN	DCON	H	LF	CDX	LU	WF	K7
			DT4	ZM3								
SBFB020R005F	R	0.05	●	●	2.2	2	1.8	50	0.25	8	0.95	30°
SBFB025R005F	R	0.05	●	●	2.7	2.5	2.3	50	0.3	12.5	1.2	30°
SBFB025R015F	R	0.15	●	●	2.7	2.5	2.3	50	0.3	12.5	1.2	30°
SBFB030R005F	R	0.05	●	●	3.2	3	2.7	50	0.45	15	1.4	30°
SBFB030R015F	R	0.15	●	●	3.2	3	2.7	50	0.45	15	1.4	30°
SBFB035R005F	R	0.05	●	●	3.7	3.5	3.2	60	0.5	17.5	1.65	30°
SBFB035R015F	R	0.15	●	●	3.7	3.5	3.2	60	0.5	17.5	1.65	30°
SBFB040R005F	R	0.05	●	●	4.2	4	3.6	60	0.5	20	1.9	30°
SBFB040R015F	R	0.15	●	●	4.2	4	3.6	60	0.5	20	1.9	30°
SBFB050R005F	R	0.05	●	●	5.2	5	4.5	70	0.7	25	2.4	30°
SBFB050R015F	R	0.15	●	●	5.2	5	4.5	70	0.7	25	2.4	30°
SBFB060R005F	R	0.05	●	●	6.2	6	5.4	80	0.9	30	2.9	30°
SBFB060R015F	R	0.15	●	●	6.2	6	5.4	80	0.9	30	2.9	30°

● : Line up

Grade 1
Insert 2
Ext. Toolholder 3
Int. Toolholder 4
Threading 5
Grooving 6
Shaper 7
Endmill 8
Drilling Tool 9
Technical Reference 10

STICK DUO

INSERT BAR

SBFS-H without chipbreaker

Mirror finish edge

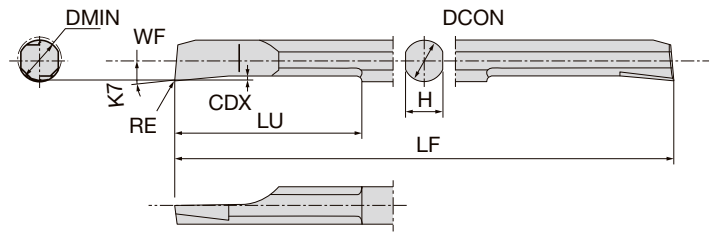
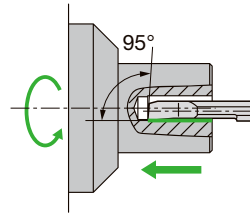

Right hand (R) shown.

P	Steel	☆
M	Stainless	★
N	Non-ferrous	★
S	Superalloys	
H	Hard materials	

★ : First choice
☆ : Second choice

Designation	HAND	RE	Coated		DMIN	DCON	H	LF	CDX	LU	WF	K7
			ZM3									
SBFS020R005H	R	0.05	●	Ⓜ	2.2	2	1.8	50	0.25	10	0.9	5°
SBFS025R005H	R	0.05	●	Ⓜ	2.7	2.5	2.3	50	0.3	12.5	1.15	5°
SBFS025R015H	R	0.15	●	Ⓜ	2.7	2.5	2.3	50	0.3	12.5	1.15	5°
SBFS030R005H	R	0.05	●	Ⓜ	3.2	3	2.7	50	0.4	15	1.4	5°
SBFS030R015H	R	0.15	●	Ⓜ	3.2	3	2.7	50	0.4	15	1.4	5°
SBFS035R005H	R	0.05	●	Ⓜ	3.7	3.5	3.2	60	0.4	17.5	1.65	5°
SBFS035R015H	R	0.15	●	Ⓜ	3.7	3.5	3.2	60	0.4	17.5	1.65	5°
SBFS040R005H	R	0.05	●	Ⓜ	4.2	4	3.6	60	0.45	20	1.9	5°
SBFS040R015H	R	0.15	●	Ⓜ	4.2	4	3.6	60	0.45	20	1.9	5°
SBFS050R005H	R	0.05	●	Ⓜ	5.2	5	4.5	70	0.5	25	2.4	5°
SBFS050R015H	R	0.15	●	Ⓜ	5.2	5	4.5	70	0.5	25	2.4	5°
SBFS060R005H	R	0.05	●	Ⓜ	6.2	6	5.4	80	0.6	30	2.9	5°
SBFS060R015H	R	0.15	●	Ⓜ	6.2	6	5.4	80	0.6	30	2.9	5°
SBFS080R005H	R	0.05	●	Ⓜ	8.2	8	7.3	80	0.8	30	3.9	5°
SBFS080R015H	R	0.15	●	Ⓜ	8.2	8	7.3	80	0.8	30	3.9	5°

● : Line up

SHFS-S with chipbreaker

Sharp cutting edge

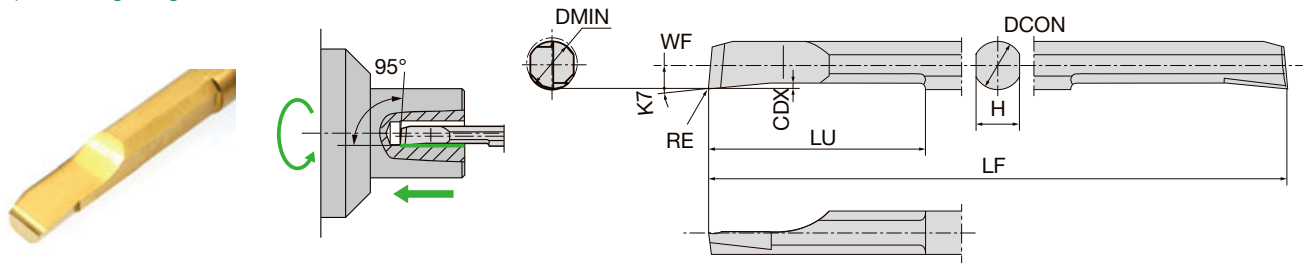

P	Steel	★
M	Stainless	★
N	Non-ferrous	★
S	Superalloys	★
H	Hard materials	☆

★ : First choice
☆ : Second choice

Designation	HAND	RE	Coated	DMIN	DCON	H	LF	CDX	LU	WF	K7
			TM4								
SHFS020R005S	R	0.05	●	2.2	2	1.8	50	0.25	10	0.9	5°
SHFS025R005S	R	0.05	●	2.7	2.5	2.3	50	0.3	12.5	1.15	5°
SHFS025R015S	R	0.15	●	2.7	2.5	2.3	50	0.3	12.5	1.15	5°
SHFS030R005S	R	0.05	●	3.2	3	2.7	50	0.4	15	1.4	5°
SHFS030R015S	R	0.15	●	3.2	3	2.7	50	0.4	15	1.4	5°
SHFS035R005S	R	0.05	●	3.7	3.5	3.2	60	0.4	17.5	1.65	5°
SHFS035R015S	R	0.15	●	3.7	3.5	3.2	60	0.4	17.5	1.65	5°
SHFS040R005S	R	0.05	●	4.2	4	3.6	60	0.45	20	1.9	5°
SHFS040R015S	R	0.15	●	4.2	4	3.6	60	0.45	20	1.9	5°
SHFS050R005S	R	0.05	●	5.2	5	4.5	70	0.5	25	2.4	5°
SHFS050R015S	R	0.15	●	5.2	5	4.5	70	0.5	25	2.4	5°

● : Line up

Grade 1
Insert 2
Ext. Toolholder 3
Int. Toolholder 4
Threading 5
Grooving 6
Shaper 7
Endmill 8
Drilling Tool 9
Technical Reference 10

STICK DUO

INSERT BAR

SHFB-F with chipbreaker

Evacuates chips BACKWARD

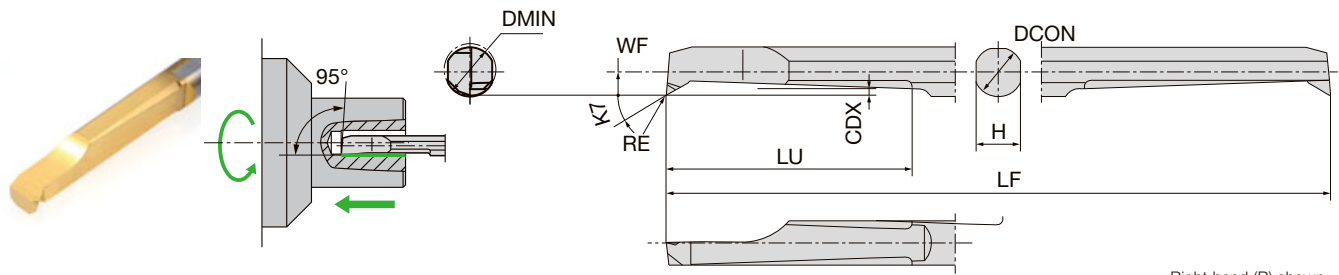

P	Steel	★
M	Stainless	★
N	Non-ferrous	★
S	Superalloys	★
H	Hard materials	☆

★ : First choice
☆ : Second choice

Designation	HAND	RE	Coated	DMIN	DCON	H	LF	CDX	LU	WF	K7
			TM4								
SHFB020R005F	R	0.05	●	2.2	2	1.8	50	0.25	8	0.95	30°
SHFB025R005F	R	0.05	●	2.7	2.5	2.3	50	0.3	12.5	1.2	30°
SHFB025R015F	R	0.15	●	2.7	2.5	2.3	50	0.3	12.5	1.2	30°
SHFB030R005F	R	0.05	●	3.2	3	2.7	50	0.45	15	1.4	30°
SHFB030R015F	R	0.15	●	3.2	3	2.7	50	0.45	15	1.4	30°
SHFB035R005F	R	0.05	●	3.7	3.5	3.2	60	0.5	17.5	1.65	30°
SHFB035R015F	R	0.15	●	3.7	3.5	3.2	60	0.5	17.5	1.65	30°
SHFB040R005F	R	0.05	●	4.2	4	3.6	60	0.5	20	1.9	30°
SHFB040R015F	R	0.15	●	4.2	4	3.6	60	0.5	20	1.9	30°
SHFB050R005F	R	0.05	●	5.2	5	4.5	70	0.7	25	2.4	30°
SHFB050R015F	R	0.15	●	5.2	5	4.5	70	0.7	25	2.4	30°

● : Line up

SHFS-H without chipbreaker

Mirror finish edge

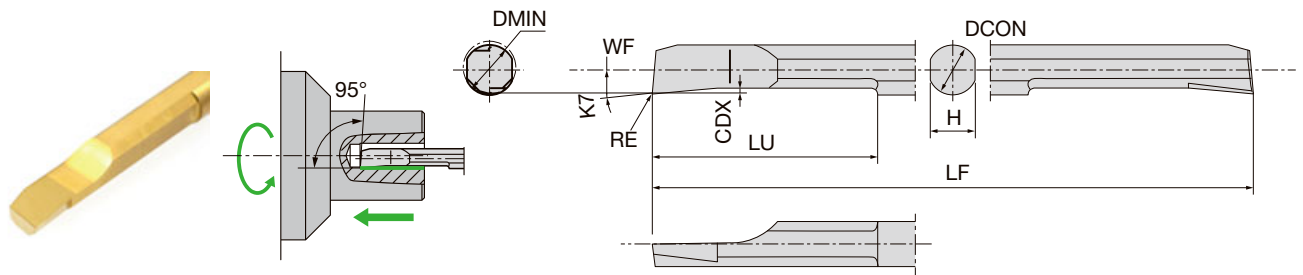

Right hand (R) shown.

P	Steel	★
M	Stainless	★
N	Non-ferrous	★
S	Superalloys	★
H	Hard materials	☆

★ : First choice
☆ : Second choice

Designation	HAND	RE	Coated		DMIN	DCON	H	LF	CDX	LU	WF	K7
			TM4									
SHFS020R005H	R	0.05	●	Ⓜ	2.2	2	1.8	50	0.25	10	0.9	5°
SHFS025R005H	R	0.05	●	Ⓜ	2.7	2.5	2.3	50	0.3	12.5	1.15	5°
SHFS025R015H	R	0.15	●	Ⓜ	2.7	2.5	2.3	50	0.3	12.5	1.15	5°
SHFS030R005H	R	0.05	●	Ⓜ	3.2	3	2.7	50	0.4	15	1.4	5°
SHFS030R015H	R	0.15	●	Ⓜ	3.2	3	2.7	50	0.4	15	1.4	5°
SHFS035R005H	R	0.05	●	Ⓜ	3.7	3.5	3.2	60	0.4	17.5	1.65	5°
SHFS035R015H	R	0.15	●	Ⓜ	3.7	3.5	3.2	60	0.4	17.5	1.65	5°
SHFS040R005H	R	0.05	●	Ⓜ	4.2	4	3.6	60	0.45	20	1.9	5°
SHFS040R015H	R	0.15	●	Ⓜ	4.2	4	3.6	60	0.45	20	1.9	5°
SHFS050R005H	R	0.05	●	Ⓜ	5.2	5	4.5	70	0.5	25	2.4	5°
SHFS050R015H	R	0.15	●	Ⓜ	5.2	5	4.5	70	0.5	25	2.4	5°

● : Line up

Grade 1
Insert 2
Ext. Toolholder 3
Int. Toolholder 4
Threading 5
Grooving 6
Shaper 7
Endmill 8
Drilling Tool 9
Technical Reference 10

STICK DUO

INSERT BAR for ID Back Turning

SBB-S with chipbreaker

Short type / Two-sided

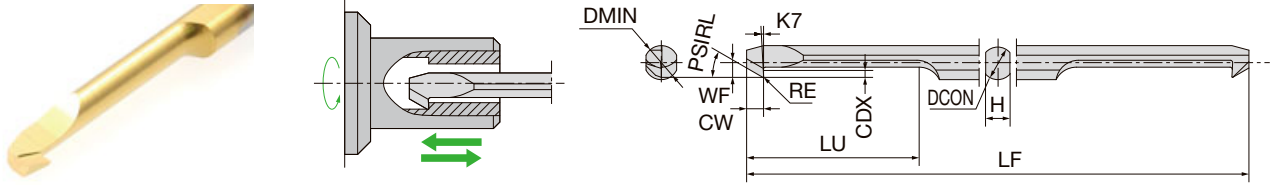

Right hand (R) shown.

P	Steel	☆
M	Stainless	★
N	Non-ferrous	★
S	Superalloys	★
H	Hard materials	☆

★ : First choice
☆ : Second choice

Designation	HAND	RE	Coated	DMIN	DCON	H	LF	CDX	LU	WF	K7	CW	PSIRL
			ZM3										
SBB030RB005-S	R	0.05	●	3	3	2.7	50	0.5	15	1.3	3°	1.5	30°
SBB030RB010-S	R	0.1	●	3	3	2.7	50	0.5	15	1.3	3°	1.5	30°
SBB040RB005-S	R	0.05	●	4	4	3.6	60	0.8	18	1.8	3°	1.5	30°
SBB040RB015-S	R	0.15	●	4	4	3.6	60	0.8	18	1.8	3°	1.5	30°

● : Line up

SBB with chipbreaker

Long type / Single-sided

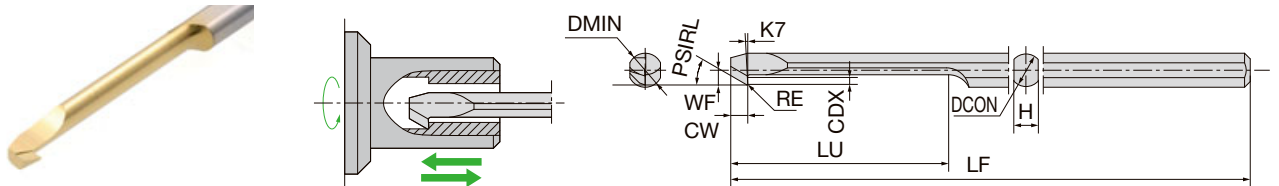

Right hand (R) shown.

P	Steel	☆
M	Stainless	★
N	Non-ferrous	★
S	Superalloys	★
H	Hard materials	☆

★ : First choice
☆ : Second choice

Designation	HAND	RE	Coated	DMIN	DCON	H	LF	CDX	LU	WF	K7	CW	PSIRL
			ZM3										
SBB030RB005	R	0.05	●	3	3	2.7	50	0.5	19	1.3	3°	1.5	30°
SBB030RB010	R	0.1	●	3	3	2.7	50	0.5	19	1.3	3°	1.5	30°
SBB040RB005	R	0.05	●	4	4	3.6	60	0.8	24	1.8	3°	1.5	30°
SBB040RB015	R	0.15	●	4	4	3.6	60	0.8	24	1.8	3°	1.5	30°

● : Line up

INSERT BAR for ID Grooving

SBG-S with chipbreaker

Short type / Two-sided

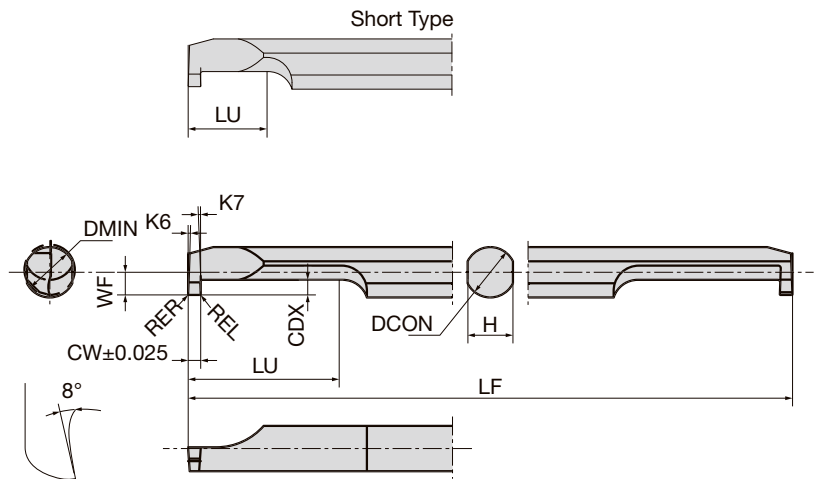
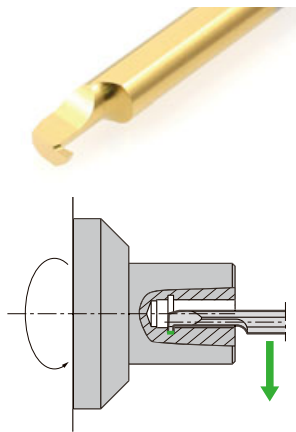

Right hand (R) shown.

P	Steel	☆
M	Stainless	★
N	Non-ferrous	★
S	Superalloys	★
H	Hard materials	☆

★ : First choice
☆ : Second choice

Designation	HAND	RE	Coated	DMIN	APMX	DCON	H	LF	CDX	LU	WF	K7	K6	CW
			ZM3											
SBG030050RB-S	R	0.05	●	3	0.8	3	2.7	50	1	4.5	1.3	2°	2°	0.5
SBG030075RB-S	R	0.05	●	3	0.8	3	2.7	50	1	4.5	1.3	2°	2°	0.75
SBG030100RB-S	R	0.05	●	3	0.8	3	2.7	50	1	4.5	1.3	2°	2°	1
SBG030150RB-S	R	0.05	●	3	0.8	3	2.7	50	1	4.5	1.3	2°	2°	1.5
SBG040050RB-S	R	0.05	●	4	1	4	3.6	60	1.2	6	1.8	2°	2°	0.5
SBG040075RB-S	R	0.05	●	4	1	4	3.6	60	1.2	6	1.8	2°	2°	0.75
SBG040100RB-S	R	0.05	●	4	1	4	3.6	60	1.2	6	1.8	2°	2°	1
SBG040150RB-S	R	0.05	●	4	1	4	3.6	60	1.2	6	1.8	2°	2°	1.5
SBG050050RB-S	R	0.05	●	5	1.2	5	4.5	70	1.4	7.5	2.3	2°	2°	0.5
SBG050100RB-S	R	0.05	●	5	1.2	5	4.5	70	1.4	7.5	2.3	2°	2°	1
SBG050150RB-S	R	0.05	●	5	1.2	5	4.5	70	1.4	7.5	2.3	2°	2°	1.5
SBG050200RB-S	R	0.05	●	5	1.2	5	4.5	70	1.4	7.5	2.3	2°	2°	2
SBG060100RB-S	R	0.05	●	6	1.8	6	5.4	80	2	7.5	2.8	2°	2°	1
SBG060150RB-S	R	0.05	●	6	1.8	6	5.4	80	2	7.5	2.8	2°	2°	1.5
SBG060200RB-S	R	0.05	●	6	1.8	6	5.4	80	2	7.5	2.8	2°	2°	2
SBG080100RB-S	R	0.05	●	8	2.2	8	7.3	80	2.4	8.5	3.8	2°	2°	1
SBG080150RB-S	R	0.05	●	8	2.2	8	7.3	80	2.4	8.5	3.8	2°	2°	1.5
SBG080200RB-S	R	0.05	●	8	2.2	8	7.3	80	2.4	8.5	3.8	2°	2°	2

● : Line up

Grade 1
Insert 2
Ext. Toolholder 3
Int. Toolholder 4
Threading 5
Grooving 6
Shaper 7
Endmill 8
Drilling Tool 9
Technical Reference 10

STICK DUO

INSERT BAR for ID Grooving

SBG with chipbreaker

Long type / Two-sided

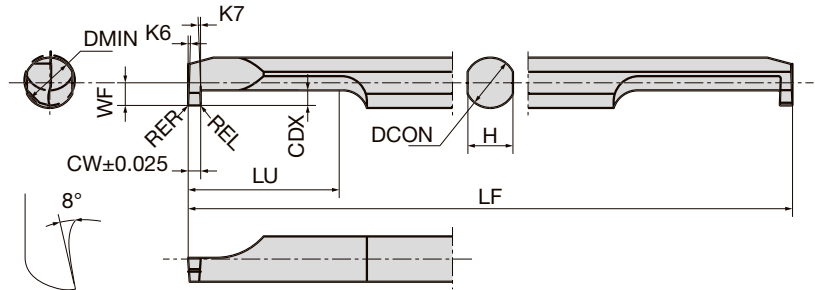
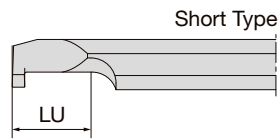
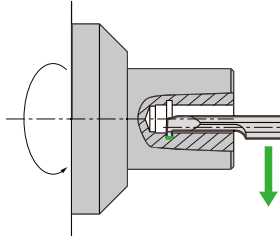

Right hand (R) shown.

P	Steel	☆
M	Stainless	★
N	Non-ferrous	★
S	Superalloys	★
H	Hard materials	☆

★ : First choice
☆ : Second choice

Designation	HAND	RE	Coated	DMIN	APMX	DCON	H	LF	CDX	LU	WF	K7	K6	CW
			ZM3											
SBG030050RB	R	0.05	●	3	0.8	3	2.7	50	1	9	1.3	2°	2°	0.5
SBG030075RB	R	0.05	●	3	0.8	3	2.7	50	1	9	1.3	2°	2°	0.75
SBG030100RB	R	0.05	●	3	0.8	3	2.7	50	1	9	1.3	2°	2°	1
SBG040050RB	R	0.05	●	4	1	4	3.6	60	1.2	12	1.8	2°	2°	0.5
SBG040075RB	R	0.05	●	4	1	4	3.6	60	1.2	12	1.8	2°	2°	0.75
SBG040100RB	R	0.05	●	4	1	4	3.6	60	1.2	12	1.8	2°	2°	1
SBG050050RB	R	0.05	●	5	1.2	5	4.5	70	1.4	20	2.3	2°	2°	0.5
SBG050100RB	R	0.05	●	5	1.2	5	4.5	70	1.4	20	2.3	2°	2°	1
SBG050150RB	R	0.05	●	5	1.2	5	5.4	70	1.4	20	2.3	2°	2°	1.5
SBG060100RB	R	0.05	●	6	1.8	6	5.4	80	2	20	2.8	2°	2°	1
SBG060150RB	R	0.05	●	6	1.8	6	5.4	80	2	20	2.8	2°	2°	1.5
SBG060200RB	R	0.05	●	6	1.8	6	7.3	80	2	20	2.8	2°	2°	2
SBG080100RB	R	0.05	●	8	2.2	8	7.3	80	2.4	20	3.8	2°	2°	1
SBG080150RB	R	0.05	●	8	2.2	8	4.5	80	2.4	20	3.8	2°	2°	1.5
SBG080200RB	R	0.05	●	8	2.2	8	7.3	80	2.4	20	3.8	2°	2°	2

● : Line up

INSERT BAR for ID Face Grooving

SFG with chipbreaker

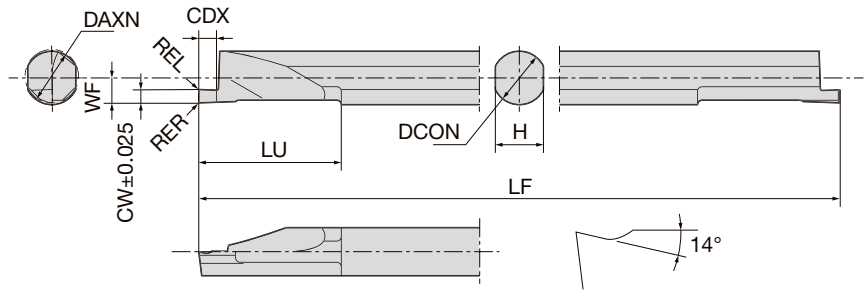
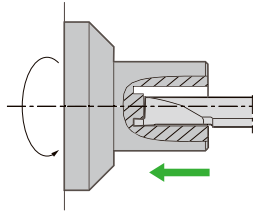

Right hand (R) shown.

P	Steel	★
M	Stainless	★
N	Non-ferrous	★
S	Superalloys	
H	Hard materials	

★ : First choice
☆ : Second choice

Designation	HAND	RE	Coated	DMIN	APMX	DCON	H	LF	CDX	LU	WF	CW
			TM4									
SFG060R100B	R	0.05	●	6	1.5	6	5.4	80	1.7	16	2.8	1
SFG060R150B	R	0.05	●	6	2	6	5.4	80	2.2	16	2.8	1.5
SFG060R200B	R	0.05	●	6	3	6	5.4	80	3.2	16	2.8	2
SFG080R100B	R	0.05	●	8	1.5	8	7.3	80	1.7	16	3.8	1
SFG080R150B	R	0.05	●	8	2	8	7.3	80	2.2	16	3.8	1.5
SFG080R200B	R	0.05	●	8	3	8	7.3	80	3.2	16	3.8	2
SFG080R300B	R	0.05	●	8	3	8	7.3	80	3.2	16	3.8	3

● : Line up

Grade 1
Insert 2
Ext. Toolholder 3
Int. Toolholder 4
Threading 5
Grooving 6
Shaper 7
Endmill 8
Drilling Tool 9
Technical Reference 10

STICK DUO

INSERT BAR for Internal Thread

SBT

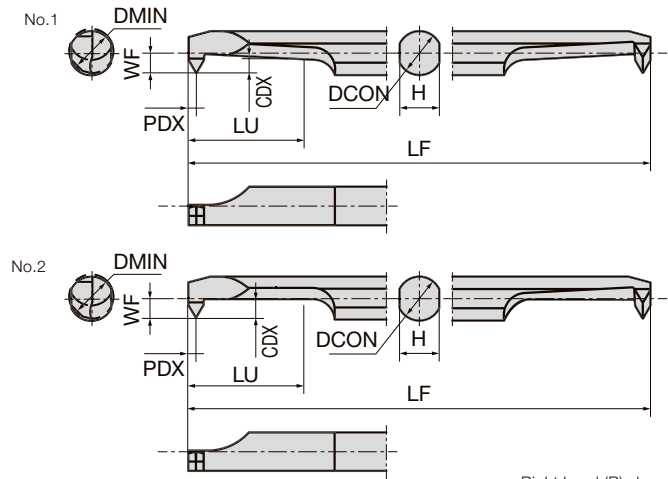
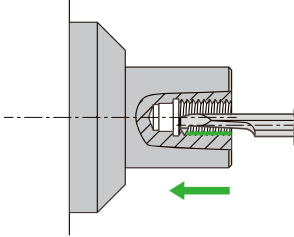
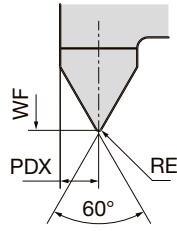

Right hand (R) shown.

P	Steel	☆
M	Stainless	★
N	Non-ferrous	★
S	Superalloys	
H	Hard materials	

★ : First choice
☆ : Second choice

Designation	HAND	RE	Coated	chip-breaker	DMIN	DCON	H	LF	WF	Pitch	CDX	LU	PDX	Figure
			ZM3											
SBT025M3R	R	0.05MAX Flat	●	No	2.5	2.5	2.3	50	1.1	0.5	0.6	5.4	0.4	1
SBT030M4R	R	0.05MAX Flat	●	No	3	3	2.7	50	1.3	0.5-0.8	0.8	7.5	0.5	1
SBT030M4RB	R	0.05MAX Flat	●	Yes	3	3	2.7	50	1.3	0.5-0.8	0.8	7.5	0.5	1
SBT035M5RB	R	0.05MAX Flat	●	Yes	3.5	3.5	3.2	60	1.55	0.5-1	1	8.5	0.55	1
SBT040M6RB	R	0.05	●	Yes	4	4	3.6	60	1.8	0.75-1.25	1.2	10.5	0.7	1
SBT050M8RB	R	0.05	●	Yes	5	5	4.5	70	2.3	0.75-1.5	1.5	15.8	0.8	2
SBT060M10RB	R	0.05	●	Yes	6	6	5.4	80	2.8	0.75-1.75	1.8	18.4	0.95	2

No.1: Eccentric tapered shape

● : Line up

MEMO

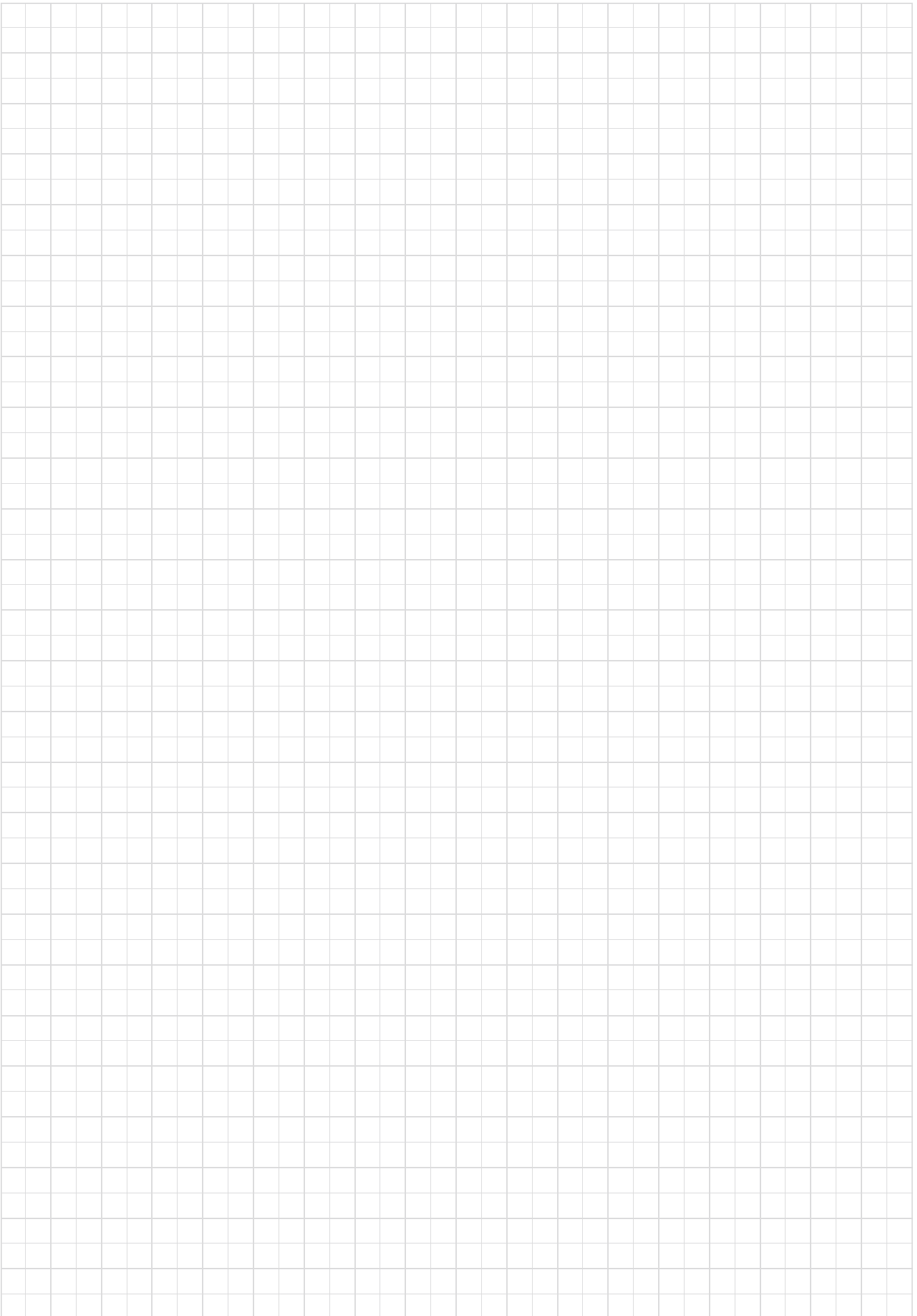

Grade **1**

Insert **2**

Ext. Toolholder **3**

Int. Toolholder **4**

Threading **5**

Grooving **6**

Shaper **7**

Endmill **8**

Drilling Tool **9**

Technical Reference **10**

5. Threading



Main products

Thread form

60° 5-10

55° 5-13

M (Metric) 5-14

UN (Unified) 5-18

W (Whitworth) 5-20

BSPT (R, PT) 5-21

NPT 5-22

NPTF 5-23

UNJ 5-24



TUNGTHREAD

Lay down insert, toolholder

Standard items cover a wide variety of threading inserts. Standard tool series with double-clamp system for excellent insert stability in machining API-standard threads.

5-10 -



TETRAMCUT

Standard tool with 4 corners for threading on Swiss lathes. In small diameter threading using the center of the tool post on general NC lathes, interference with the center is less likely occur.

5-11 -



DUOJUST

Standard tool suitable for all types of threading on Swiss lathes. The incomplete thread part from the workpiece face to the thread groove can be the shortest thanks to the excellent accessibility to the workpiece face.

5-12 -



MINIVLOCK

High precision grooving and threading tool series for CNC automatic lathes.

5-27



SOLIDTHREAD

Solid threading tool series for machining small diameters, such as M1x0.25 and 0-80UNF.

5-44 -



TUNGMEISTER

Endmills with exchangeable heads for reduced tool change time
ø6 mm - ø20 mm

5-54 -



CSV Series

Best for machining with ultra small diameter of ø5 or less
Possible to use on cam-type automatic lathes

5-25 -

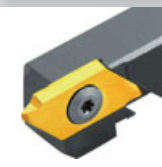

TTP Series

 Cover wide range with single point cutting
Achieve burr-free thread surface by high precision sharp edge

5-33 -



STICK DUO -SBT-

 For internal threading minimum diameter ø2.5
Economical 2 corners solid bar with wide range of choice

5-36 -







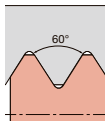
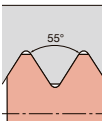
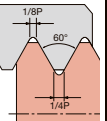
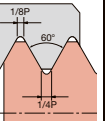
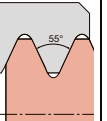
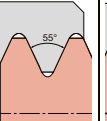
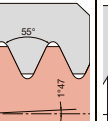
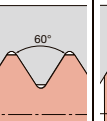
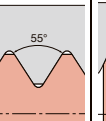
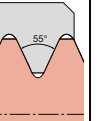

Thread whirling

High productivity for precision screw manufacturing, like dental implant screws and bone screws

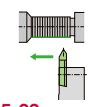
5-9, 5-44 -

Applicable tool for each external thread type

Applicable tool for each external thread type		General purpose, Machine parts for machine and automotive parts				For valve and pump parts; pneumatic, hydraulic, oil and gas pipes					Aerospace threads
Thread types		60°	55°	ISO metric threads, coarse and fine	Unified national threads series, 60° inch threads	- British standard whitworth - British standard fine	- British standard parallel pipe - British standard pipe - Parallel pipe thread (JIS B 9912) - 55° inch thread	- JIS tapered pipe thread - British standard pipe taper	National pipe taper thread	National pipe taper fuel thread	Unified inch screw threads
Thread symbols		M, UN, UNC, UNF, UNEF, UNS	G, BSP, PF, BSPP	M	UN, UNR, UNC, UNRC, UNF, UNRF, UNEF, UNREF, UNS, UNRS	BSW, BSF, W	G, BSP, PF, BSPP	R, PT, BSPT	NPT	NPTF	UNJ, UNJC, UNJF, UNUEF, UNJS
Thread form											
Tool type	Full profile										
	With	With out									
 5-25	●	0.2 ~ 0.5 mm 127 ~ 51TPI	—	—	—	—	—	—	—	—	—
 5-33	●	0.2 ~ 2 mm 127 ~ 13TPI	0.5 ~ 1.5 mm 48 ~ 16TPI	—	—	—	—	—	—	—	—
 5-12	●	0.2 ~ 1.5 mm 127 ~ 16TPI	—	—	—	—	—	—	—	—	—
 5-27	●	0.4 ~ 2 mm 64 ~ 12TPI	0.6 ~ 1.5 mm 40 ~ 16TPI	—	—	—	—	—	—	—	—
 5-11	●	—	—	0.5 - 1.5 mm 5-17	VN 32 - 16 TPI	W 28 - 11 TPI	55 28 - 11 TPI	—	—	—	UNJ 32 - 28 TPI
	●	0.4 ~ 3 mm 64 ~ 8TPI	0.9 ~ 3 mm 28 ~ 8TPI	—	—	—	—	—	—	—	—
 5-10	●	—	—	0.35 - 3 mm 5-14	32 - 8 TPI 5-18	32 - 8 TPI 5-20	28 - 8 TPI 5-20	28 - 11 TPI 5-21	27 - 8 TPI 5-22	27 - 8 TPI 5-23	32 - 8 TPI 5-24
	●	0.5 ~ 3 mm 48 ~ 8TPI	0.5 ~ 3 mm 48 ~ 8TPI	—	—	—	—	—	—	—	—

Applicable tool for each Internal thread type

Applicable tool for each external thread type		General purpose, Machine parts for machine and automotive parts				For valve and pump parts; pneumatic, hydraulic, oil and gas pipes				
Thread types		60°	55°	ISO metric threads, coarse and fine	Unified national threads series, 60° inch threads	- British standard whitworth - British standard fine	- British standard parallel pipe - British standard pipe - Parallel pipe thread (JIS B 9912) - 55° inch thread	- JIS tapered pipe thread - British standard pipe taper	National pipe taper thread	National pipe taper fuel thread
Thread symbols		M, UN, UNC, UNF, UNEF, UNS	G, BSP, PF, BSPP	M	UN, UNR, UNC, UNRC, UNF, UNRF, UNEF, UNREF, UNS, UNRS	BSW, BSF, W	G, BSP, PF, BSPP	R, PT, BSPT	NPT	NPTF
Thread form										
Tool type	Full profile									
	With	With out								
 4-64	●	0.5 ~ 1.75 mm 51 ~ 15TPI 4-64	—	—	—	—	—	—	—	—
	●	—	—	—	—	—	—	—	—	—
 4-38	●	0.5 ~ 1.5 mm 48 ~ 16TPI 4-38	60°	—	—	—	—	—	—	—
	●	—	—	—	—	—	—	—	—	—
 5-43	●	0.5 ~ 1.25 mm 48 ~ 20TPI 5-43	60°	—	—	—	—	—	—	—
	●	—	—	—	—	—	—	—	—	—
 5-10	●	—	—	0.5 - 3 mm 5-14	32 - 8 TPI 5-18	32 - 8 TPI 5-20	28 - 8 TPI 5-20	19 - 11 TPI 5-21	27 - 8 TPI 5-22	14 - 8 TPI 5-23
	●	0.5 ~ 3 mm 48 ~ 8TPI 5-10	0.5 ~ 3 mm 48 ~ 8TPI 5-13	—	—	—	—	—	—	—

Grade
Insert
Ext. Toolholder
Int. Toolholder
Threading
Grooving
Shaper
Endmill
Drilling Tool
Technical Reference



Miniature Threading - Quick Guide





External Threading

CSV





Application	Designation	Insert	Square shank (height x width)					Corner R (mm)	Pitch (mm)					Page	
			7 x 7	8 x 8	9.5 x 9.5	10 x 10	12 x 12		0	1	2	3	4		5
	CSVR/L	CSVT	●	●	●	●	●	0.03 Max	0.2	0.5					5-25











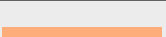

TetraMini-Cut

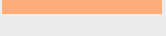
Application	Designation	Insert	Square shank (height x width)						Cylindrical shank (shank dia.)						
			10 x 10	12 x 12	12 x 16	16 x 16	16 x 20	20 x 20	ø14	ø15.875	ø16	ø19.05	ø20	ø22	
	QC-STCR/L-Y-CHP Modular head	TCT18R/L...		●	●	●	●								
	QC-STCR/L-CHP Modular head	TCT18R/L...		●	●	●	●								
	STCR/L-18	TCT18R/L...	●	●		●		●							
	JS-STCL18	TCT18R...							●	●	●	●	●	●	●
	QR-STCL18-CHP	TCT18R...									●	●	●		

TTP series

Application	Designation	Insert	Square shank (height x width)							Cylindrical shank (shank dia.)					
			8 x 10	10 x 10	10 x 12	12 x 12	16 x 16	20 x 20	25 x 25	ø16	ø19.05	ø20	ø22	ø25	ø25.4
	TTPR/L-OH2/OH3	TTP			●	●	●								
	TTPR/L	TTP	●	●		●	●	●							
	TTPL-F	TTP				●	●								
	CH-TTPL	TTP					●	●							
	DS-TTPL	TTP								●	●	●	●	●	●

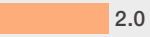
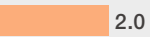
			Corner R (mm)	Holder				Pitch (mm)						Page
	ø25	ø25.4		Modular head	Y-axis feed	Through-coolant	Direct connection	0	1	2	3	4	5	
								0.4  3						
			0.05 - 0.2	●	●	●	●	0.4  3						5-29
			0.05 - 0.2	●		●	●	0.4  3						5-29
			0.05 - 0.2					0.4  3						5-30
	●	●	0.05 - 0.2					0.4  3						5-30
			0.05 - 0.2	●		●		0.4  3						5-31

	Corner R (mm)	Holder		Pitch (mm)						Page
		Through-coolant	Direct connection	0	1	2	3	4	5	
				0.2  2.0						
		●	●	0.2  2.0						5-33
				0.2  2.0						5-34
				0.2  2.0						5-35
				0.2  2.0						5-35
				0.2  2.0						5-36

Grade

1

Insert

2

Ext. Toolholder

3

Int. Toolholder

4

Threading

5

Grooving

6

Shaper

7

Endmill

8

Drilling Tool

9





Technical Reference

10





Miniature Threading - Quick Guide

External Threading



 **DuoJust-Cut**





Application	Designation	Insert	Square shank (height x width)					Cylindrical shank (shank dia.)						
			10 x 10	10 x 12	12 x 12	16 x 16	20 x 20	ø16	ø19.05	ø20	ø22	ø25	ø25.4	
	JSXXR/L*09-CHP	JXTG12...		●	●	●								
	JSXXR/L*09-S-CHP	JXTG12...			●	●								
	JS-SXXL09	JXTG12R...							●	●	●	●	●	
	QR-SXXL09-CHP	JXTG12R...						●	●	●				





 **TungThread**

Application	Designation	Insert	Square shank (height x width)						Cylindrical shank (shank dia.)						
			8 x 8	10 x 10	12 x 12	16 x 16	20 x 10	20 x 20	24 x 12	24 x 16	32 x 16	ø16	ø19.05	ø20	ø25
	SER*11	11ER...	●	●											
	JSE2R16-CHP	16ER...			●	●									
	CER/L	16ER/L...			●	●		●							
	JS-SEL16	16ER...									●	●	●	●	●

 **MiniVLockGroove**

Application	Designation	Insert	Square shank (height x width)				Corner R (mm)	Holder			Pitch (mm)						Page	
			10 x 10	10 x 12	12 x 12	12 x 16		MODUMTURN (Modular head)	TUNGJET (Through-coolant)	Direct connection	0	1	2	3	4	5		
	QC12-SVER/L-CHP Modular head	VGT10F...		●	●	●	0.05 - 0.1	●	●	●	0.4	2						5-27
	SVER/L	VGT10F...	●		●		0.05 - 0.1	●	●		0.4	2						5-22

Corner R (mm)	Holder		Pitch (mm)					Page	
	TUNGSTET (Through-coolant)	Direct connection	0	1	2	3	4		5
			0.2  1.5						
0.05Max. - 0.1	●	●	0.2  1.5					5-38	
0.05Max. - 0.1	●	●	0.2  1.5					5-38	
0.05Max. - 0.1			0.2  1.5					5-39	
0.05Max. - 0.1			0.2  1.5					5-39	

Corner R (mm)	Holder			Pitch (mm)					Page
	MODUM TM TURN (Modular head)	TUNGSTET (Through-coolant)	Direct connection	1	2	3	4	5	
				0.35  1.5					
0.04 - 0.19				0.35  1.5					5-40
0.05 - 0.22	●	●	●	0.5  3					5-40
0.05 - 0.22				0.5  3					5-41
0.05 - 0.22				0.5  3					5-41

Grade

1

Insert

2

Ext. Toolholder

3

Int. Toolholder

4

Threading

5

Grooving

6

Shaper

7

Endmill

8

Drilling Tool

9

Technical Reference

10

Miniature Threading - Quick Guide

Internal Threading



TungThread

Application	Designation	Insert	Min. bore diameter DMIN (mm)	Corner R (mm)	Pitch (mm)						Page
					0	1	2	3	4	5	
	SIR	6/8IR...	ø6.4 - ø8	0.04 - 0.17	0.5		2				5-42
	SNR	6IR...	ø8 - ø10	0.04 - 0.1	0.5		1.75				5-42

Thread Whirling

For high-efficiency thread cutting | Swiss CNC Lathes

High productivity for precision screw manufacturing, like dental implant screws and bone screws

Ideal for medical screw thread forms that are becoming more complex
Single pass thread forming reduces cycle time



Double lead thread

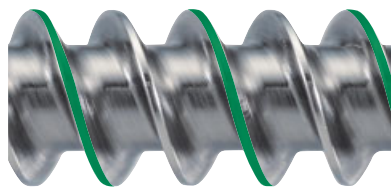
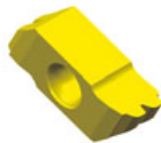

Triple lead thread

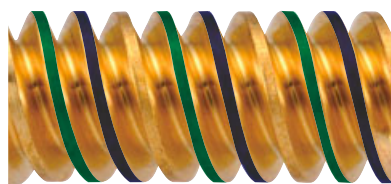
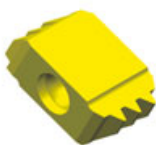

Grade

1

Insert

2

Ext. Toolholder

3

Int. Toolholder

4

Threading

5

Grooving

6

Shaper

7

Endmill

8

Drilling Tool

9

Technical Reference

10

Partial-profile insert with chipbreaker

Insert size	Pitch (Reference)	TPI	Hand of cut	External insert								Internal insert													
				Designation	Grade			IC	PDX	PDY	RE	Designation	Grade			IC	PDX	PDY	RE						
					Coated								Cermet							Coated			Cermet		
					AH8015	AH725	NS9530						AH8015	AH725	NS9530										
11	0.5 - 1.5	48 - 16	R							11IRA60-B	●			6.35	0.9	0.7	0.04								
11	0.5 - 1.5	48 - 16	R							11IRA60-M	●		●	6.35	0.9	0.7	0.04								
16	0.5 - 1.5	48 - 16	R	16ERA60-B	●*			9.525	0.9	0.8	0.05	16IRA60-B	●*			9.525	0.9	0.8	0.05						
16	0.5 - 1.5	48 - 16	R	16ERA60-M	●		●	9.525	0.9	0.7	0.06	16IRA60-M	●		●	9.525	0.9	0.7	0.04						
16	0.5 - 3	48 - 8	R	16ERAG60-B	●*			9.525	1.7	1.2	0.08	16IRAG60-B	●*			9.525	1.7	1.2	0.05						
16	0.5 - 3	48 - 8	R	16ERAG60-M	●	●	●	9.525	1.6	1.2	0.06	16IRAG60-M	●	●	●	9.525	1.6	1.2	0.04						
16	1.75 - 3	14 - 8	R	16ERG60-B	●*			9.525	1.7	1.2	0.25	16IRG60-B	●*			9.525	1.7	1.2	0.1						
16	1.75 - 3	14 - 8	R	16ERG60-M	●		●	9.525	1.6	1.2	0.22	16IRG60-M	●		●	9.525	1.6	1.2	0.14						

- ●* : The cutting edge position needs re-adjusting for these inserts have different PDY and PDX dimensions (Note: for size 16 inserts only).

- ■ requires the use of dedicated shim.

When using a new AH725 with chipbreaker, the conventional shim may need to be replaced with a new standard shim.

● : Line up / 5 pieces per package

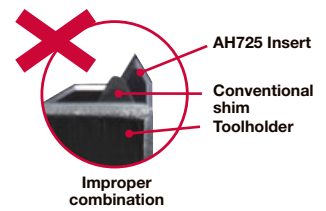

TETRAMCUT INSERT

60° thread angle (General purpose)

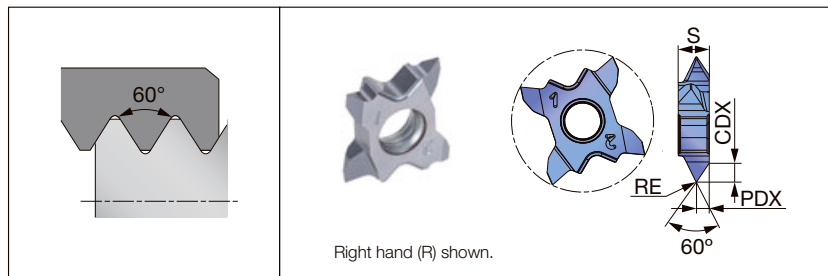

Applicable toolholder

External
STCR/L**-18
STCR/L**18-CHP
JS**-STCL18
C*STCFL**18-CHP
C*STCR/L**18-CHP
QC**STCR/L18 (-Y)
QC**STCR/L18 (-Y)-CHP

Partial-profile insert

Pitch	TPI	Hand of cut	External insert							
			Designation	Grade		PDX	CDX	RE	S	
				Coated						
				SH725	AH725					
0.4 - 1	25 - 64	R	TCT18FR-60A-005	●		0.6	0.99	0.05	4	
1 - 2	25 - 12	R	TCT18FR-60A-010	●		1	1.63	0.1	4	
0.8 - 3	8 - 32	R/L	TCT18R/L-60N-010		●	1.6	2.67	0.1	4	
1.5 - 3	8 - 16	R/L	TCT18R/L-60N-020		●	1.6	2.57	0.2	4	

● : Line up / 5 pieces per package

Reference pages: Toolholders → [5-29](#) - [5-31](#)

60° thread angle (General purpose)

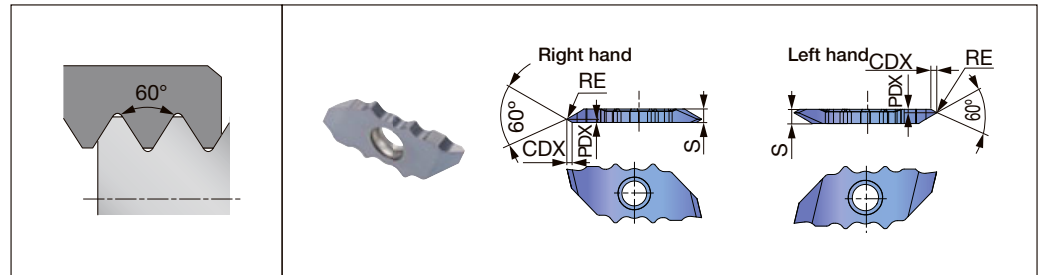

Applicable toolholder

External
JSXXR/L**09
JSXXR/L**09-CHP
JS**-SXXL09

Thread form

60°

55°

M (Metric)

UN (Unified)

W (Whitworth)

BSPT (R, PT)

NPT

NPTF

UNJ

Partial-profile insert

Insert size	Pitch	TPI	Hand of cut	External insert						
				Designation	Grade		PDX	CDX	RE	S
					Coated					
					R	L				
12	0.2 - 0.4	64 - 127	R/L	JXTG12FR/L-60A-000	●	●	0.25	0.4	0.05 max flat	2.5
12	0.2 - 0.4	64 - 127	R/L	JXTG12FR/L-60B-000	●	●	2.25	0.4	0.05 max flat	2.5
12	0.4 - 1	25 - 64	R/L	JXTG12FR/L-60A-005	●	●	0.6	0.99	0.05	2.5
12	0.4 - 1	25 - 64	R/L	JXTG12FR/L-60B-005	●	●	1.9	0.99	0.05	2.5
12	1 - 1.5	16 - 25	R/L	JXTG12FR/L-60N-010	●	●	1.25	2.07	0.1	2.5

● : Line up / 5 pieces per package

	Type A	Type B	Type N
Right hand			
Left hand			

ISO metric (General purpose)

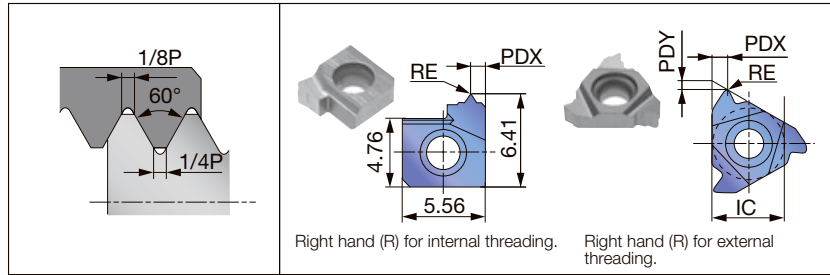

Applicable toolholder

Insert size	External	Internal
6		SNR/L000*K06SC... SNR/L000*H06...
06		SIR0005...
08		SIR0007...
11	SER**11	
16	CER/L**16... (C*CER/L...) JSER**16... JS**SEL16	

Full-profile insert

Insert size	Pitch (Reference)	Hand of cut	External insert								Internal insert									
			Designation	Grade				IC	PDX	PDY	RE	Designation	Grade				IC	PDX	PDY	RE
				Coated		Uncoated							Coated		Uncoated					
				AH8015	AH725	T313V	TH10						AH8015	AH725	T313V	TH10				
6	0.75	R								6IR075ISO	●		●	-	0.5	-	0.05			
6	1	R								6IR10ISO	●	●	●	-	0.9	-	0.07			
6	1.25	R								6IR125ISO	●	●	●	-	0.9	-	0.09			
6	1.5	R								6IR15ISO	●	●	●	-	0.9	-	0.11			
6	1.75	R								6IR175ISO	●	●	●	-	0.9	-	0.12			
6	2	R								6IR20ISO	●	●	●	-	0.9	-	0.14			
06	0.5	R								06IR05ISO	●**			4	0.4	0.6	0.04			
06	0.75	R								06IR075ISO	●**			4	0.5	0.6	0.06			
06	1	R								06IR10ISO	●**			4	0.6	0.6	0.05			
06	1.25	R								06IR125ISO	●**			4	0.6	0.6	0.07			
08	1	R								08IR10ISO	●**			5	0.6	0.6	0.07			
08	1.25	R								08IR125ISO	●**			5	0.7	0.7	0.09			
08	1.5	R								08IR15ISO	●**			5	0.7	0.7	0.1			
08	1.75	R								08IR175ISO	●**			5	0.8	0.6	0.15			
11	0.35	R	11ER035ISO	●				6.35	0.4	0.6	0.04									
11	0.5	R	11ER05ISO	●				6.35	0.6	0.6	0.07	11IR05ISO	●	●	6.35	0.5	1.2	0.04		
11	0.7	R	11ER07ISO	●				6.35	0.6	0.6	0.11									
11	0.75	R	11ER075ISO	●				6.35	0.6	0.6	0.11	11IR075ISO	●	●	6.35	0.5	1.2	0.05		
11	0.8	R	11ER080ISO	●				6.35	0.6	0.6	0.12									
11	1	R	11ER10ISO	●				6.35	0.7	0.7	0.15	11IR10ISO	●	●	6.35	0.9	0.7	0.07		
11	1	L										11IL10ISO	●	●	6.35	0.9	0.7	0.07		
11	1.25	R	11ER125ISO	●				6.35	0.9	0.8	0.16	11IR125ISO	●		6.35	0.9	0.7	0.09		
11	1.25	L										11IL125ISO	●		6.35	0.9	0.7	0.09		
11	1.5	R	11ER15ISO	●				6.35	0.8	1	0.19	11IR15ISO	●	●	6.35	0.9	0.7	0.11		
11	1.5	L										11IL15ISO	●	●	6.35	0.9	0.7	0.11		
11	1.75	R										11IR175ISO	●	●	6.35	0.9	0.7	0.12		
11	1.75	L										11IL175ISO	●		6.35	0.9	0.7	0.12		
11	2	R										11IR20ISO	●	●	6.35	0.9	0.7	0.14		
11	2	L										11IL20ISO	●	●	6.35	0.9	0.7	0.14		

●** : Both ..06IR... and ..08IR... inserts have 3 cutting edges.

● : Line up / 5 pieces per package

Reference pages: External toolholders → 5-40 - 5-41
Internal toolholders → 5-42

Insert size	Pitch (Reference)	Hand of cut	External insert										Internal insert									
			Designation	Grade				IC	PDX	PDY	RE	Designation	Grade				IC	PDX	PDY	RE		
				Coated			Uncoated						Coated			Uncoated						
				AH8015	AH725	T313V	TH10						AH8015	AH725	T313V	TH10						
16	0.5	R	16ER05ISO	●	●	●	●	9.525	0.5	1.2	0.06	16IR05ISO	●	●	●	●	9.525	0.5	1.2	0.04		
16	0.75	R	16ER075ISO	●	●	●	●	9.525	0.5	1.2	0.09	16IR075ISO	●	●	●	●	9.525	0.5	1.2	0.05		
16	1	R	16ER10ISO	●	●	●	●	9.525	0.9	0.7	0.13	16IR10ISO	●	●	●	●	9.525	0.9	0.7	0.07		
16	1	L										16IL10ISO	●	●	●	●	9.525	0.9	0.7	0.07		
16	1.25	R	16ER125ISO	●	●	●	●	9.525	0.9	0.7	0.16	16IR125ISO	●	●	●	●	9.525	0.9	0.7	0.09		
16	1.25	L										16IL125ISO	●	●	●	●	9.525	0.9	0.7	0.09		
16	1.5	R	16ER15ISO	●	●	●	●	9.525	0.9	0.7	0.19	16IR15ISO	●	●	●	●	9.525	0.9	0.7	0.11		
16	1.5	L	16EL15ISO	●	●	●	●	9.525	0.9	0.7	0.19	16IL15ISO	●	●	●	●	9.525	0.9	0.7	0.11		
16	1.75	R	16ER175ISO	●	●	●	●	9.525	1.6	1.2	0.22	16IR175ISO	●	●	●	●	9.525	1.6	1.2	0.12		
16	2	R	16ER20ISO	●	●	●	●	9.525	1.6	1.2	0.25	16IR20ISO	●	●	●	●	9.525	1.6	1.2	0.14		
16	2	L	16EL20ISO	●	●	●	●	9.525	1.6	1.2	0.25	16IL20ISO	●	●	●	●	9.525	1.6	1.2	0.14		
16	2.5	R	16ER25ISO	●	●	●	●	9.525	1.6	1.2	0.31	16IR25ISO	●	●	●	●	9.525	1.6	1.2	0.18		
16	3	R	16ER30ISO	●	●	●	●	9.525	1.6	1.2	0.38	16IR30ISO	●	●	●	●	9.525	1.6	1.2	0.21		
16	3	L										16IL30ISO	●	●	●	●	9.525	1.6	1.2	0.21		

● : Line up / 5 pieces per package

Reference pages: External toolholders → 5-40 - 5-41
Internal toolholders → 5-42

Grade
Insert
Ext. Toolholder
Int. Toolholder
Threading
Grooving
Shaper
Endmill
Drilling Tool
Technical Reference

Full-profile insert with chipbreaker

Insert size	Pitch (Reference)	Hand of cut	External insert								Internal insert							
			Designation	Grade			IC	PDX	PDY	RE	Designation	Grade			IC	PDX	PDY	RE
				Coated		Cermet						Coated		Cermet				
				AH8015	AH725	NS9530						AH8015	AH725	NS9530				
11	0.5	R								11IR05ISO-B	●		6.35	0.5	1.2	0.04		
11	0.5	R								11IR05ISO-M		●	6.35	0.5	1.2	0.04		
11	0.75	R								11IR075ISO-B	●		6.35	0.5	1.2	0.05		
11	0.75	R								11IR075ISO-M		●	6.35	0.5	1.2	0.05		
11	1	R								11IR10ISO-B		●	6.35	0.9	0.7	0.08		
11	1	R								11IR10ISO-M	●		6.35	0.9	0.7	0.08		
11	1.25	R								11IR125ISO-B		●	6.35	0.9	0.7	0.1		
11	1.25	R								11IR125ISO-M	●		6.35	0.9	0.7	0.1		
11	1.5	R								11IR15ISO-B		●	6.35	0.9	0.7	0.12		
11	1.5	R								11IR15ISO-M	●		6.35	0.9	0.7	0.12		
11	1.75	R								11IR175ISO-B		●	6.35	0.9	0.7	0.12		
11	1.75	R								11IR175ISO-M		●	6.35	0.9	0.7	0.12		
11	2	R								11IR20ISO-B		●	6.35	0.9	0.7	0.14		
11	2	R								11IR20ISO-M	●		6.35	0.9	0.7	0.14		
16	0.5	R	16ER05ISO-M			●	9.525	0.5	1.2	0.06								
16	0.75	R	16ER075ISO-B			●*	9.525	0.6	0.6	0.08								
16	0.75	R	16ER075ISO-M	●		●	9.525	0.5	1.2	0.09								
16	1	R	16ER10ISO-B			●*	9.525	0.7	0.7	0.11	16IR10ISO-B		●*	9.525	0.7	0.6	0.05	
16	1	R	16ER10ISO-M	●		●	9.525	0.9	0.7	0.13	16IR10ISO-M	●		9.525	0.9	0.7	0.08	
16	1.25	R	16ER125ISO-B			●*	9.525	0.9	0.8	0.14	16IR125ISO-B		●*	9.525	0.9	0.8	0.06	
16	1.25	R	16ER125ISO-M	●		●	9.525	0.9	0.7	0.16	16IR125ISO-M		●	9.525	0.9	0.7	0.1	
16	1.5	R	16ER15ISO-B			●*	9.525	1	0.8	0.19	16IR15ISO-B		●*	9.525	1	0.8	0.08	
16	1.5	R	16ER15ISO-M	●		●	9.525	0.9	0.7	0.19	16IR15ISO-M	●		9.525	0.9	0.7	0.12	
16	1.75	R	16ER175ISO-B			●*	9.525	1.2	0.9	0.25	16IR175ISO-B		●*	9.525	1.2	0.9	0.10	
16	1.75	R	16ER175ISO-M	●		●	9.525	1.6	1.2	0.22	16IR175ISO-M		●	9.525	1.6	1.2	0.14	
16	2	R	16ER20ISO-B			●*	9.525	1.3	1	0.28	16IR20ISO-B		●*	9.525	1.3	1	0.11	
16	2	R	16ER20ISO-M	●		●	9.525	1.6	1.2	0.25	16IR20ISO-M	●		9.525	1.6	1.2	0.14	
16	2.5	R	16ER25ISO-B			●*	9.525	1.5	1.1	0.3	16IR25ISO-B		●*	9.525	1.5	1.1	0.14	
16	2.5	R	16ER25ISO-M	●		●	9.525	1.6	1.2	0.31	16IR25ISO-M		●	9.525	1.6	1.2	0.18	
16	3	R	16ER30ISO-B			●*	9.525	1.6	1.2	0.38	16IR30ISO-B		●*	9.525	1.5	1.1	0.22	
16	3	R	16ER30ISO-M	●		●	9.525	1.6	1.2	0.38	16IR30ISO-M	●		9.525	1.6	1.2	0.21	

- ●* : The cutting edge position needs re-adjusting for these inserts have different PDY and PDX dimensions (Note: for size 16 inserts only).

- requires the use of dedicated shim.

When using a new AH725 with chipbreaker, the conventional shim may need to be replaced with a new standard shim.

● : Line up / 5 pieces per package

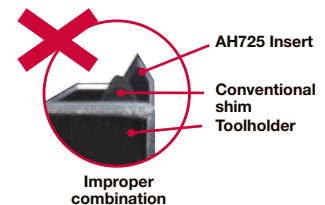

Reference pages: External toolholders → [5-40 - 5-41](#)
Internal toolholders → [5-42](#)

ISO metric (General purpose)

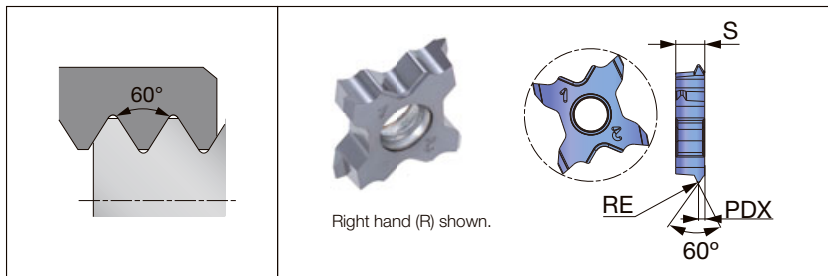

Applicable toolholder

External
STCR/L**-18
STCR/L**18-CHP
JS**-STCL18
C*STCFL**18-CHP
C*STCR/L**18-CHP
QC**STCR/L18 (-Y)
QC**STCR/L18 (-Y)-CHP

Partial-profile insert

Pitch	Hand of cut	Designation	External insert				
			Grade		PDX	RE	S
			Coated				
			SH725	AH725			
0.5	R	TCT18FR-05ISO	●		0.35	0.06	4
0.7	R	TCT18FR-07ISO	●		0.45	0.09	4
0.75	R	TCT18FR-075ISO	●		0.5	0.09	4
0.8	R	TCT18FR-08ISO	●		0.5	0.1	4
1	R	TCT18R-10ISO		●	0.6	0.13	4
1.25	R	TCT18R-125ISO		●	0.7	0.17	4
1.5	R	TCT18R-15ISO		●	0.8	0.2	4

● : Line up / 5 pieces per package

Full-profile insert with chipbreaker

Insert size	Pitch (Reference)	TPI	Hand of cut	External insert								Internal insert								
				Designation	Grade			IC	PDX	PDY	RE	Designation	Grade			IC	PDX	PDY	RE	
					Coated		Cermet						Coated		Cermet					
					AH8015	AH725	NS9530						AH8015	AH725	NS9530					
16	(1.058)	24	R	16ER24UN-B		●*			9.525	0.8	0.7	0.11								
16	(1.058)	24	R	16ER24UN-M			●		9.525	0.9	0.7	0.13								
16	(1.27)	20	R	16ER20UN-B		●*			9.525	0.9	0.8	0.14	16IR20UN-B		●*		9.525	0.9	0.8	0.06
16	(1.27)	20	R	16ER20UN-M	●		●		9.525	0.9	0.7	0.16	16IR20UN-M			●	9.525	0.9	0.7	0.09
16	(1.411)	18	R	16ER18UN-B		●*			9.525	1	0.8	0.15	16IR18UN-B		●*		9.525	1	0.8	0.08
16	(1.411)	18	R	16ER18UN-M	●		●		9.525	0.9	0.7	0.18	16IR18UN-M	●		●	9.525	0.9	0.7	0.1
16	(1.588)	16	R	16ER16UN-B		●*			9.525	1.1	0.9	0.19	16IR16UN-B		●*		9.525	1.1	0.9	0.09
16	(1.588)	16	R	16ER16UN-M	●		●		9.525	0.9	0.7	0.2	16IR16UN-M			●	9.525	0.9	0.7	0.11
16	(1.814)	14	R	16ER14UN-B		●*			9.525	1.2	1	0.22	16IR14UN-B		●*		9.525	1.2	0.9	0.11
16	(1.814)	14	R	16ER14UN-M	●		●		9.525	1.6	1.2	0.23	16IR14UN-M			●	9.525	1.6	1.2	0.13
16	(1.954)	13	R	16ER13UN-B		●*			9.525	1.3	1	0.24								
16	(2.117)	12	R	16ER12UN-B		●*			9.525	1.4	1.1	0.25	16IR12UN-B		●*		9.525	1.4	1.1	0.12
16	(2.117)	12	R	16ER12UN-M	●		●		9.525	1.6	1.2	0.27	16IR12UN-M	●		●	9.525	1.6	1.2	0.15
16	(3.175)	8	R	16ER8UN-B		●*			9.525	1.6	1.2	0.41	16IR8UN-B		●*		9.525	1.5	1.1	0.2
16	(3.175)	8	R	16ER8UN-M			●		9.525	1.6	1.2	0.4	16IR8UN-M			●	9.525	1.6	1.2	0.22

● : Line up / 5 pieces per package

- ●* : The cutting edge position needs re-adjusting for these inserts have different PDY and PDX dimensions (Note: for size 16 inserts only).
 - requires the use of dedicated shim.
- When using a new AH725 with chipbreaker, the conventional shim may need to be replaced with a new standard shim.

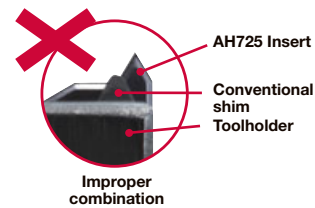

NPTF (for Pipe)

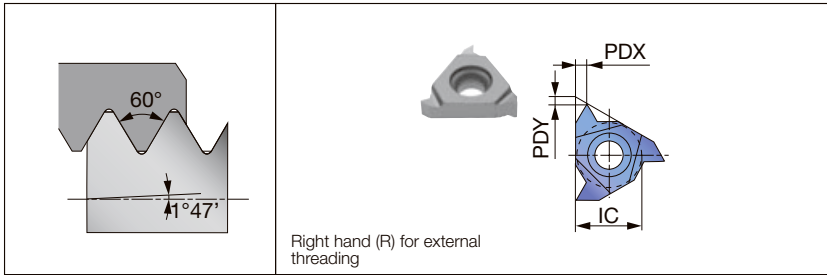

Applicable toolholder

Insert size	External	Internal
16	CER/L**16... (C*CER/L...) JSER**16... JS**SEL16	

Full-profile insert

Insert size	Pitch (Reference)	TPI	Hand of cut	External insert					Internal insert						
				Designation	Grade	IC	PDX	PDY	RE	Designation	Grade	IC	PDX	PDY	RE
					Coated						Coated				
					AH725						AH725				
16	(0.941)	27	R	16ER27NPTF	●	9.525	0.5	1.2	-						
16	(1.411)	18	R	16ER18NPTF	●	9.525	0.9	0.7	-						
16	(1.814)	14	R	16ER14NPTF	●	9.525	1.6	1.2	-	16IR14NPTF	●	9.525	1.6	1.2	-
16	(2.209)	11.5	R	16ER115NPTF	●	9.525	1.6	1.2	-	16IR115NPTF	●	9.525	1.6	1.2	-
16	(3.175)	8	R	16ER8NPTF	●	9.525	1.6	1.2	-	16IR8NPTF	●	9.525	1.6	1.2	-

● : Line up / 5 pieces per package

Round / DIN405 (for Machine parts)



Applicable toolholder

Insert size	External	Internal
16	CER/L**16... (C*CER/L...) JSER**16... JS**SEL16 SER**16-CHP B-SER/L**16 B-CER/L**16 BC-SER/L**16	TSNR/L**16 SNR/L**16... TCNR/L**16... CNR/L**16...

Full-profile insert

Insert size	Pitch (Reference)	TPI	Hand of cut	External insert					Internal insert						
				Designation	Grade	IC	PDX	PDY	RE	Designation	Grade	IC	PDX	PDY	RE
					Coated						Coated				
					AH725						AH725				
16	(3.175)	8	R	16ER8RD-B	●	9.525	1.3	1.4	0.75						
16	(4.233)	6	R	16ER6RD-B	●	9.525	1.7	1.5	1.01	16IR6RD-B	●	9.525	1.5	1.4	0.94

● : Line up / 5 pieces per package

UNJ (for Aerospace industry)

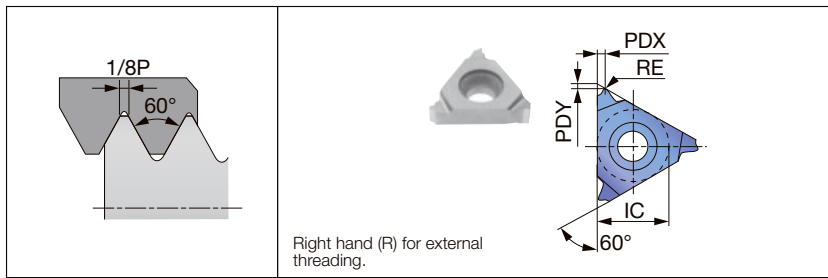

Applicable toolholder

Insert size	External
16	CER/L**16... (C*CER/L...) JSER**16... JS**SEL16

Thread form

60°

55°

M
(Metric)

UN
(Unified)

W
(Whitworth)

BSPT
(R, PT)

NPT

NPTF

UNJ

Full-profile insert

Insert size	Pitch (Reference)	TPI	Hand of cut	External insert						
				Designation	Grade		IC	PDX	PDY	RE
					Coated					
					AH8015	AH725				
16	(0.794)	32	R	16ER32UNJ	●	●	9.525	0.5	1.2	0.13
16	(0.907)	28	R	16ER28UNJ	●	●	9.525	0.5	1.2	0.15
16	(1.058)	24	R	16ER24UNJ	●	●	9.525	0.9	0.7	0.18
16	(1.27)	20	R	16ER20UNJ	●	●	9.525	0.9	0.7	0.21
16	(1.411)	18	R	16ER18UNJ	●	●	9.525	0.9	0.7	0.24
16	(1.588)	16	R	16ER16UNJ	●	●	9.525	0.9	0.7	0.26
16	(1.814)	14	R	16ER14UNJ	●	●	9.525	1.6	1.2	0.3
16	(2.117)	12	R	16ER12UNJ	●	●	9.525	1.6	1.2	0.35
16	(2.54)	10	R	16ER10UNJ	●	●	9.525	1.6	1.2	0.42
16	(3.175)	8	R	16ER8UNJ	●	●	9.525	1.6	1.2	0.53

● : Line up / 5 pieces per package

CSV

For Cam-style machine

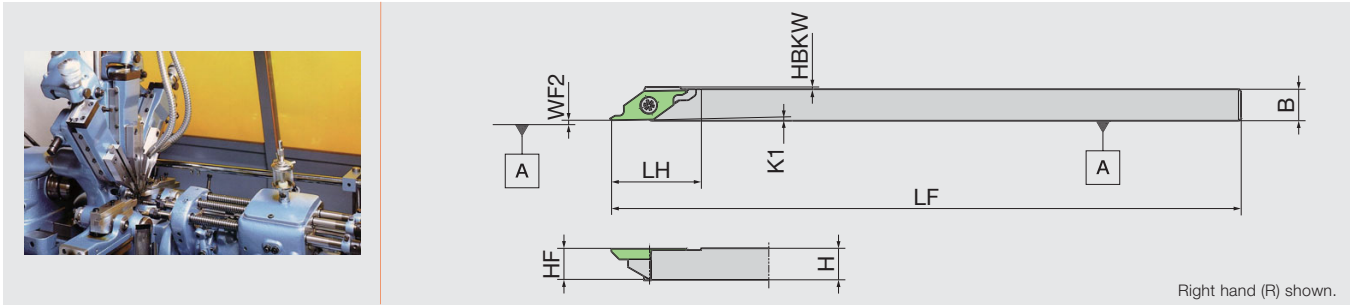

Designation	H	B	LF	LH	HBKW	HF	K1	WF2
CSVR07	7	7	140	20	0.5	7	1°	0.1
CSVR07GX	7	7	85	20	0.5	7	1°	0.1
CSVR08	8	8	140	20	0	8	1°	0.1
CSVR08GX	8	8	85	20	0	8	1°	0.1
CSVR095	9.5	9.5	140	20	0	9.5	1°	0.1
CSVR10	10	10	140	20	0	10	1°	0.1
CSVR12	12	12	140	20	0	12	1°	0.1
CSVR12GX	12	12	85	20	0	12	1°	0.1
CSVL07	7	7	140	20	0.5	7	1°	0.1
CSVL08	8	8	140	20	0	8	1°	0.1
CSVL10	10	10	140	20	0	10	1°	0.1

Insert

CSV series
 CSVF..
 CSVB..
 CSVC..
 CSVG..
 CSVT..

SPARE PARTS



Designation	Clamp screw	Wrench (for Clamp screw)
CSVR/L**	LRIS-2.5*7	CLR-15S

INSERT

CSVT-A without chipbreaker

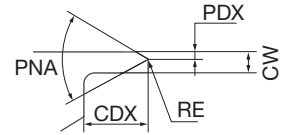
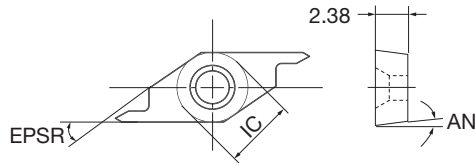

Right hand (R) shown.

P	Steel	★
M	Stainless	☆
N	Non-ferrous	
S	Superalloys	
H	Hard materials	

★ : First choice
☆ : Second choice

Designation	HAND	Coated		Pitch	PNA	CW	PDX	CDX	IC	AN	EPSR	RE
		VM1										
CSVT11FRP60-035A	R	●	Ⓜ	0.2 - 0.5	60°	1	0.35	3	6.35	7°	35°	0.03MAX
CSVT11FLP60-035A	L	●	Ⓜ	0.2 - 0.5	60°	1	0.35	3	6.35	7°	35°	0.03MAX

All angles shown are obtained when insert is set in the holder.

● : Line up

CSVT-B without chipbreaker

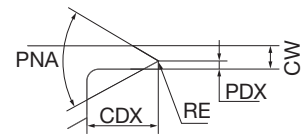
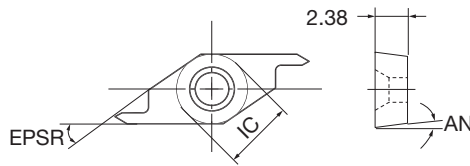

Right hand (R) shown.

P	Steel	★
M	Stainless	☆
N	Non-ferrous	
S	Superalloys	
H	Hard materials	

★ : First choice
☆ : Second choice

Designation	HAND	Coated		Pitch	PNA	CW	PDX	CDX	IC	AN	EPSR	RE
		VM1										
CSVT11FRP60-035B	R	●	Ⓜ	0.2 - 0.5	60°	1	0.35	3	6.35	7°	35°	0.03MAX
CSVT11FLP60-035B	L	●	Ⓜ	0.2 - 0.5	60°	1	0.35	3	6.35	7°	35°	0.03MAX

All angles shown are obtained when insert is set in the holder.

● : Line up

Reference pages: Inserts, Standard cutting condition → 5-28

Modular head for external grooving and threading, with high pressure coolant capability

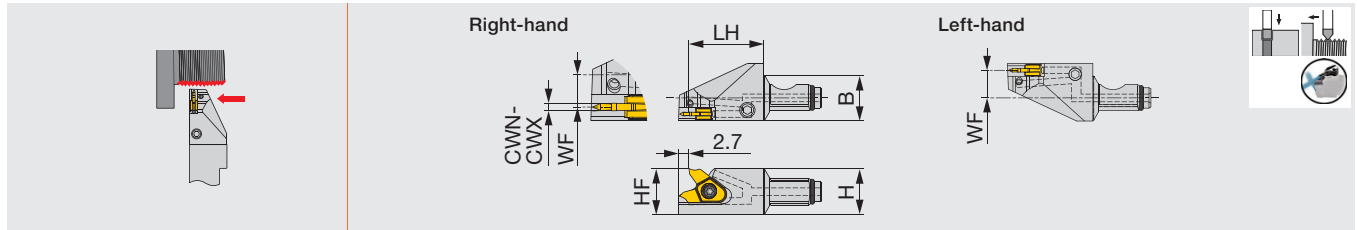

Designation	Pitch	TPI	H	B	LH	HF	WF (1)	Insert	Torque*
QC12-SVER/L10-CHP	0.4 - 1.5	64 - 12	12	12	19.5	12	4.19/7.19	VG*10...	1.3

Torque*: Recommended clamping torque (N-m)

(1) "WF" indicates the distance from the reference position to the center of the cutting edge width.

The first value before "/" indicates the WF for the right-hand holder and the second value after "/" for the left-hand holder.

SPARE PARTS



Designation	Clamping screw	Wrench 1	O-ring
QC12-SVER...	CSTB-2.5L054DL	T-7F	ORSS-0454.5X1.0NBR70
QC12-SVEL...	CSTB-2.5L054DR	T-7F	ORSS-0454.5X1.0NBR70

SVER/L

External grooving and threading toolholder

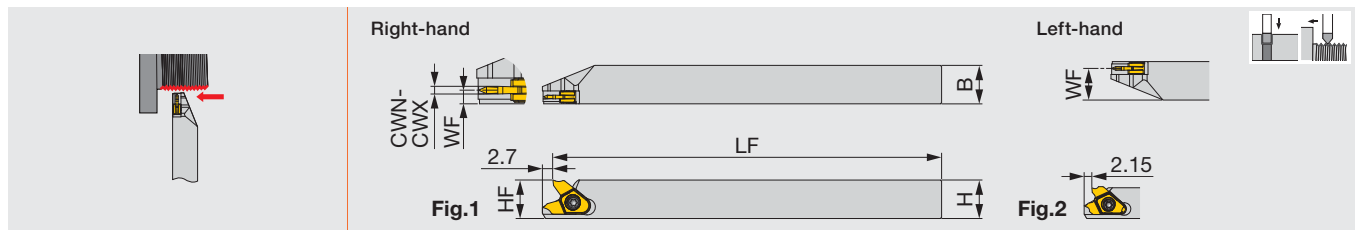

Designation	Pitch	TPI	H	B	LF	HF	WF (1)	Insert	Torque*	Fig.
SVER/L1010H10	0.4 - 1.5	64 - 12	10	10	100	10	1.78/8.23	VG*10...	1.3	1
SVER/L1212X10	0.4 - 1.5	64 - 12	12	12	120	12	1.78/10.23	VG*10...	1.3	1

Torque*: Recommended clamping torque (N-m)

(1) "WF" indicates the distance from the reference position to the center of the cutting edge width.

The first value before "/" indicates the WF for the right-hand holder and the second value after "/" for the left-hand holder.

SPARE PARTS



Designation	Clamping screw	Wrench 1	Coolant plug	Wrench 2	DirectJet plug	Wrench 3
SVER1012/1212...	CSTB-2.5L054DL	T-7F	SR5/16UNFTL360	P-4	SSHM4-6-TB	P-2
SVEL1012/1212...	CSTB-2.5L054DR	T-7F	SR5/16UNFTL360	P-4	SSHM4-6-TB	P-2
SVER1010/1212...	CSTB-2.5L054DL	T-7F	-	-	-	-
SVEL1010/1212...	CSTB-2.5L054DR	T-7F	-	-	-	-

INSERT

VGT10 (For threading / sharp edge)

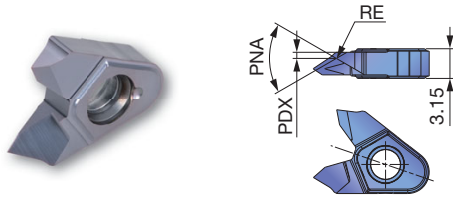

P	Steel	★				
M	Stainless	★				
K	Cast iron					
N	Non-ferrous	★				
S	Superalloys	★				
H	Hard materials					

★ : First choice

Designation	RE	Coated					Pitch	TPI	PDX	PNA
		SH725								
VGT10F-60A-005	0.05	●					0.4 - 1	64 - 25	0.66	60°
VGT10F-60A-010	0.1	●					1 - 2	25 - 12	0.96	60°
VGT10F-55A-005	0.05	●					0.6 - 1.5	40 - 16	0.85	55°

● : Line up

STANDARD CUTTING CONDITIONS

ISO	Workpiece materials	Grade	Cutting speed Vc (m/min)	Pitch (mm)	TPI
P	Low carbon steels S15C, SS400, etc. C15E4, E275A, etc.	SH725	50 - 150	0.4 - 2	64 - 12
	Carbon steels, Alloy steels S55C, SCM440, etc. C55, 42CrMo4, etc.	SH725	50 - 150	0.4 - 2	64 - 12
	Free cutting steels SUH22, SUH23, etc.	SH725	50 - 150	0.4 - 2	64 - 12
M	Stainless steels SUS304, X5CrNi18-9, etc.	SH725	50 - 100	0.4 - 2	64 - 12
N	Aluminium alloys A5056, A6061, etc.	SH725	150 - 200	0.4 - 2	64 - 12
	Copper alloy C2600, C280C, etc.	SH725	100 - 200	0.4 - 2	64 - 12
S	Titanium alloys Ti-6Al-4V, etc.	SH725	30 - 80	0.4 - 2	64 - 12
	Superalloys Inconel718, etc.	SH725	30 - 80	0.4 - 2	64 - 12

Y-axis turning modular head for external grooving and threading, with high pressure coolant capability

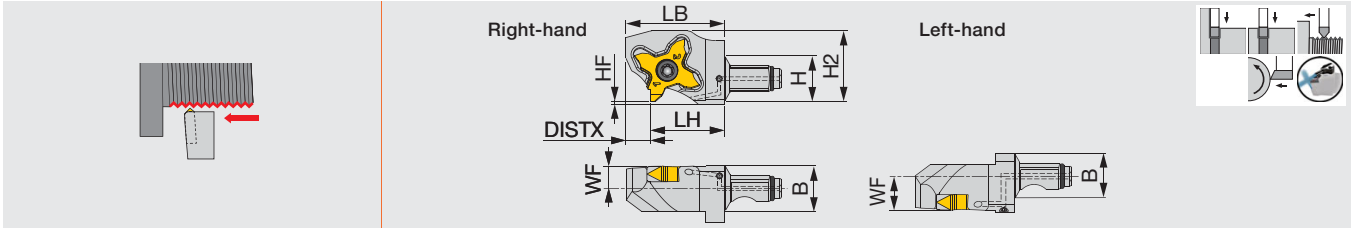

Designation	Pitch	H	B	LH	LF	WF	LB	H2	DISTX	Insert	Torque*
QC12-STCR/L18-Y-CHP	0.4 - 3	12	12	19.5	0	6	26	18.6	6.5	TC*18R/L...	1.2

Torque*: Recommended clamping torque (N-m)

The right hand insert (R) is used for the right hand toolholders (R), and the left hand insert (L) is used for the left hand toolholders (L).
Through-coolant head

SPARE PARTS

Designation	Clamping screw	Wrench	O-ring
QC12-STCR18-Y-CHP	CSTC-4L100DL	T-1008/5	ORSS-0454.5X1.0NBR70
QC12-STCL18-Y-CHP	CSTC-4L100DR	T-1008/5	ORSS-0454.5X1.0NBR70

QC12-STCR/L-CHP

Modular head for external grooving and threading, with high pressure coolant capability

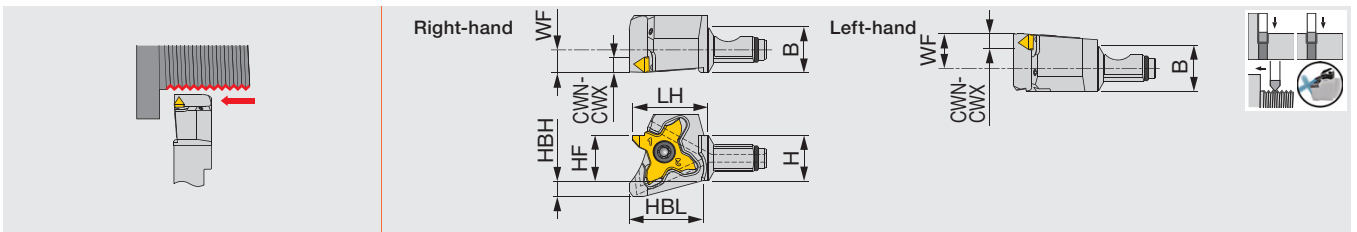

Designation	Pitch	H	B	LH	HF	HBH	HBL	WF	Insert	Torque*
QC12-STCR/L18-CHP	0.4 - 3	12	12	21	12	4.2	19.3	9	TC*18R/L...	1.2

Torque*: Recommended clamping torque (N-m)

The right hand insert (R) is used for the right hand toolholders (R), and the left hand insert (L) is used for the left hand toolholders (L).
Through-coolant head

SPARE PARTS

Designation	Clamping screw	Wrench	O-ring
QC12-STCR18-CHP	CSTC-4L100DL	T-1008/5	ORSS-0454.5X1.0NBR70
QC12-STCL18-CHP	CSTC-4L100DR	T-1008/5	ORSS-0454.5X1.0NBR70

External grooving and threading toolholder

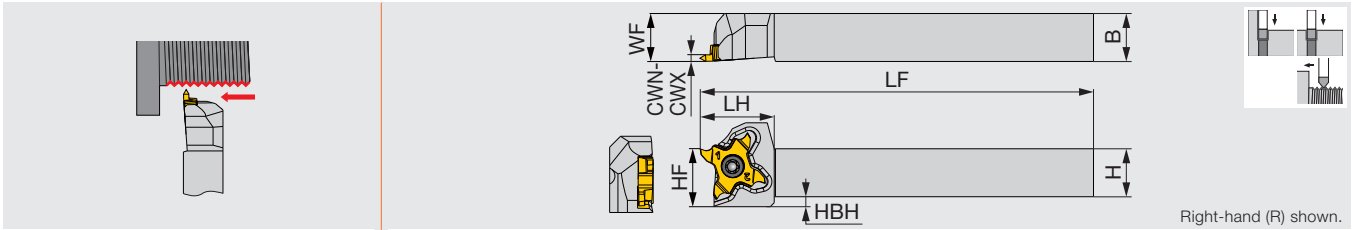

Designation	Pitch	H	B	LF	LH	HF	WF	HBH	Insert	Torque*
STCR/L1010X18	0.4 - 3	10	10	120	18.5	10	10	4.5	TC*18...	1.2
STCR/L1212F18	0.4 - 3	12	12	85	18.5	12	12	2.5	TC*18...	1.2
STCR/L1212X18	0.4 - 3	12	12	120	18.5	12	12	2.5	TC*18...	1.2
STCR/L1616X18	0.4 - 3	16	16	120	18.5	16	16	-	TC*18...	1.2
STCR/L2020H18	0.4 - 3	20	20	100	18.5	20	20	-	TC*18...	1.2
STCR/L2020X18	0.4 - 3	20	20	120	23.0	20	25	-	TC*18...	1.2

Torque*: Recommended torque (N·m) for clamping
 The right hand insert (TC*18R...) is used for the right hand toolholders (STCR...), and the left hand insert (TC*18L...) is used for the left hand toolholders (STCL...).

SPARE PARTS

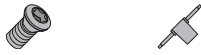

Designation	Clamping screw	Wrench
STCR...18	CSTC-4L100DL	T-1008/5
STCL...18	CSTC-4L100DR	T-1008/5

JS-STCL18

External grooving and threading toolholder with round shank, for Swiss lathes

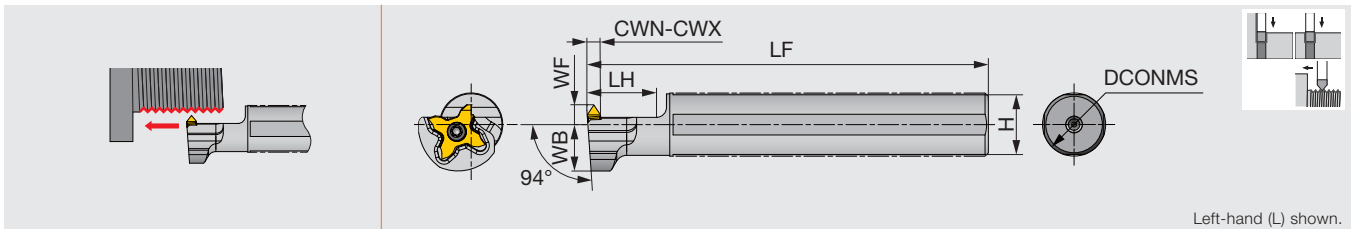

Designation	Pitch	DCONMS	H	LF	LH	WB	WF	Insert	Torque*
JS14H-STCL18	0.4 - 3	14	13	100	20	14	6	TC*18R...	1.2
JS159F-STCL18	0.4 - 3	15.875	15	85	20	14	6	TC*18R...	1.2
JS16F-STCL18	0.4 - 3	16	15	85	20	14	6	TC*18R...	1.2
JS19G-STCL18	0.4 - 3	19.05	18	90	20	14	6	TC*18R...	1.2
JS19X-STCL18	0.4 - 3	19.05	18	120	20	14	6	TC*18R...	1.2
JS20G-STCL18	0.4 - 3	20	19	90	20	14	6	TC*18R...	1.2
JS20X-STCL18	0.4 - 3	20	19	120	20	14	6	TC*18R...	1.2
JS22X-STCL18	0.4 - 3	22	21	120	20	12.25	10	TC*18R...	1.2
JS25H-STCL18	0.4 - 3	25	24	100	20	12.25	10	TC*18R...	1.2
JS254X-STCL18	0.4 - 3	25.4	24	120	20	12.25	10	TC*18R...	1.2

- The left hand toolholder (STCL...) is used with the right hand inserts (TC*18R...)
 Torque*: Recommended torque (N·m) for clamping

SPARE PARTS



Designation	Clamping screw	Wrench
JS...STCL18	CSTC-4L100DL	T-1008/5

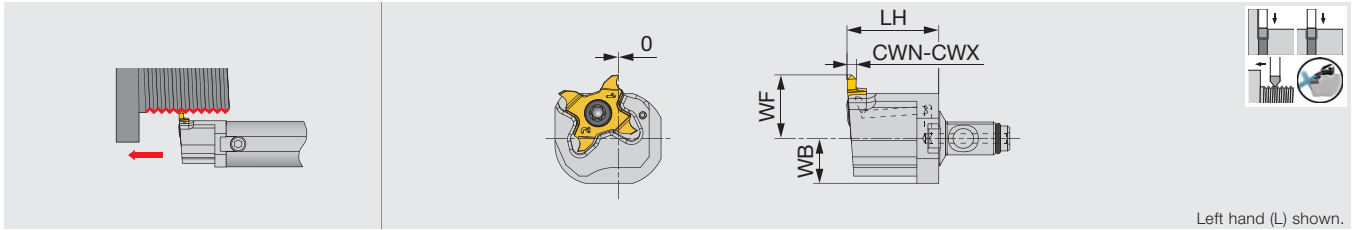

Designation	CWN	CWX	LH	WF	WB	Insert	Torque*	Shank
QR12E-STCL18-CHP	0.33	3.18	19.5	11.5	7	TC*18R...	1.2	A16*-QR12
QR12G-STCL18-CHP	0.33	3.18	19.5	13.5	8	TC*18R...	1.2	A19/20*-QR12

Use left-hand toolholders (L) with right-hand inserts (R).
 Torque*: Recommended clamping torque (N·m)
 Assembled dimensions with shank are shown on page 9.

SPARE PARTS

Designation	Clamping screw	Wrench	O-ring
QR12*-STCL18-CHP	CSTC-4L100DL	T-1008/5	ORSS-0454.5X1.0NBR70

STANDARD CUTTING CONDITIONS

TCT18FR/R-ISO (Full profile threading insert) / TCT18FR (Threading insert)

ISO	Workpiece materials	Priority	Grades	Cutting speed Vc (m/min)	Pitch (mm)	TPI
P	Low carbon steel S15C, S20C, etc. C15, C20, etc.	First choice	SH725	60 - 150	0.4 - 2.0	64 - 18
		Toughness	AH725	60 - 150	0.8 - 3.0	32 - 8
	Carbon steels, Alloy steel S55C, SCM440, etc. C55, 42CrMoS4, etc.	First choice	SH725	60 - 150	0.4 - 2.0	64 - 18
		Toughness	AH725	60 - 150	0.8 - 3.0	32 - 8
M	Prehardened steel NAK80, PX5, etc.	First choice	SH725	60 - 150	0.4 - 2.0	64 - 18
		Toughness	AH725	60 - 150	0.8 - 3.0	32 - 8
K	Stainless steel SUS304, etc. X5CrNi18-9, etc.	First choice	SH725	50 - 80	0.4 - 2.0	64 - 18
		Toughness	AH725	50 - 80	0.8 - 3.0	32 - 8
	Grey cast iron FC250, FC300, etc. 250, 300, etc.	First choice	AH725	50 - 100	0.8 - 3.0	32 - 8
		Sharpness	SH725	50 - 100	0.4 - 2.0	64 - 18
S	Ductile cast iron FCD400, FCD600, etc. 400-15, 600-3, etc.	First choice	AH725	50 - 100	0.8 - 3.0	32 - 8
		Sharpness	SH725	50 - 100	0.4 - 2.0	64 - 18
S	Titanium alloys Ti-6Al-4V, etc.	First choice	SH725	30 - 100	0.4 - 2.0	64 - 18
		Toughness	AH725	30 - 100	0.8 - 3.0	32 - 8
	Superalloys Inconel718, etc.	First choice	SH725	30 - 100	0.4 - 2.0	64 - 18
		Toughness	AH725	30 - 100	0.8 - 3.0	32 - 8

TTP-OH3

Direct connect coolant port 3-hole type

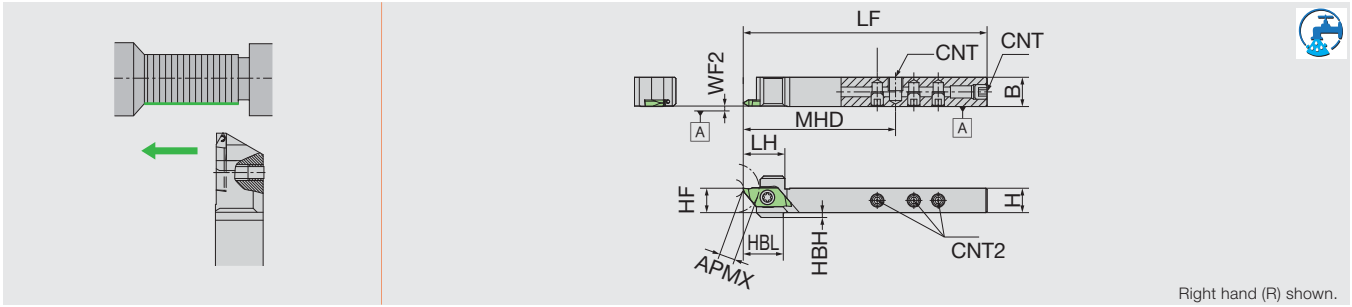

Right hand (R) shown.

Designation	Pitch	H	B	LF	LH	APMX	HBH	HBL	HF	MHD	WF2	CNT	CNT2	Insert
TTPR1012H-OH3	1.5 - 0.2	10	12	100	17.15	6.5	2	16.5	10	62.5	0	M6*1	M5	TTP..
TTPL1012H-OH3	1.5 - 0.2	10	12	100	17.15	6.5	2	16.5	10	62.5	0	M6*1	M5	TTP..

NOTE: Reference Chart of OH3 Hole Position → A011

SPARE PARTS

Designation	Clamp screw	Screw (for CNT)	Screw (for CNT2)	Wrench (for Clamp screw)	Wrench (for CNT2)
TTPR/L1012H-OH3	LRIS-4*12PW	SS0605SC	SS0505SC	CLR-15S	LW-2.5

TTP-OH2

Direct connect coolant port 1-hole type

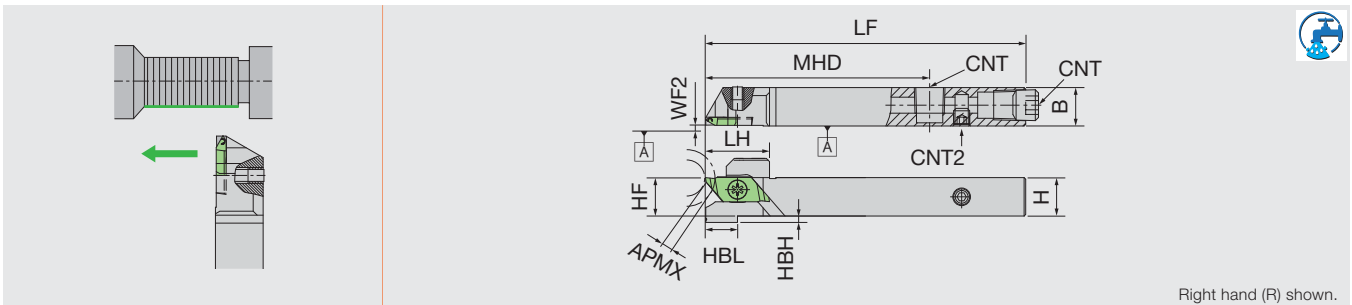

Right hand (R) shown.

Designation	Pitch	H	B	LF	LH	APMX	HBH	HBL	HF	MHD	WF2	CNT	CNT2	Insert
TTPR12H-OH2	0.2 - 1.5	12	12	100	20	5.5	2	10	12	70	0.2	Rc1/8	M5	TTP..
TTPR16X-OH2	0.2 - 1.5	16	16	120	19.5	5.5	-	-	16	70	0.2	Rc1/8	M5	TTP..
TTPL12H-OH2	0.2 - 1.5	12	12	100	20	5.5	2	10	12	70	0.2	Rc1/8	M5	TTP..
TTPL16X-OH2	0.2 - 1.5	16	16	120	19.5	5.5	-	-	16	70	0.2	Rc1/8	M5	TTP..

SPARE PARTS

Designation	Clamp screw	Screw (for CNT)	Screw (for CNT2)	Wrench (for Clamp screw)	Wrench (for CNT2)
TTPR/L*-OH2	LRIS-4*12PW	SPR1/8	SS0505SC	CLR-15S	LW-2.5

Reference pages : Inserts → 5-37

Grade
Insert
Ext. Toolholder
Int. Toolholder
Threading
Grooving
Shaper
Endmill
Drilling Tool
Technical Reference

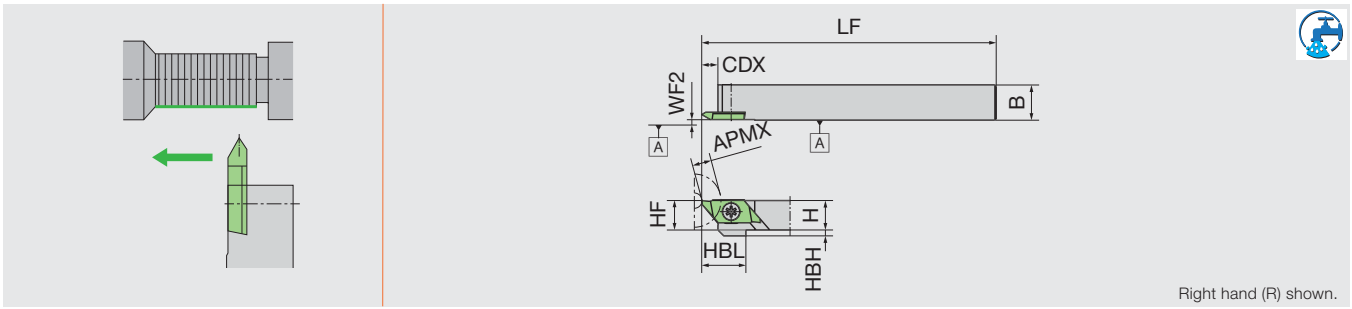

Right hand (R) shown.

Designation	Pitch	H	B	LF	APMX	CDX	HBH	HBL	HF	WF2	Insert
TTPR08	0.2 - 1.5	8	10	120	6.5	7	4	15	8	0.2	TTP..
TTPR10	0.2 - 1.5	10	10	120	6.5	7	2	15	10	0.2	TTP..
TTPR12	0.2 - 1.5	12	12	120	6.5	7	-	-	12	0.2	TTP..
TTPR12GX	0.2 - 1.5	12	12	85	6.5	7	-	-	12	0.2	TTP..
TTPR16	0.2 - 1.5	16	16	120	6.5	7	-	-	16	0.2	TTP..
TTPR16H	0.2 - 1.5	16	16	100	6.5	7	-	-	16	0.2	TTP..
TTPR20F	0.2 - 1.5	20	20	80	6.5	7	-	-	20	0.2	TTP..
TTPL08	0.2 - 1.5	8	10	120	6.5	7	4	15	8	0.2	TTP..
TTPL10	0.2 - 1.5	10	10	120	6.5	7	2	15	10	0.2	TTP..
TTPL12	0.2 - 1.5	12	12	120	6.5	7	-	-	12	0.2	TTP..
TTPL12GX	0.2 - 1.5	12	12	85	6.5	7	-	-	12	0.2	TTP..
TTPL16	0.2 - 1.5	16	16	120	6.5	7	-	-	16	0.2	TTP..
TTPL16H	0.2 - 1.5	16	16	100	6.5	7	-	-	16	0.2	TTP..
TTPL20F	0.2 - 1.5	20	20	80	6.5	7	-	-	20	0.2	TTP..

SPARE PARTS



Designation	Clamp screw	Wrench (for Clamp screw)
TTPR/L08	LRIS-4*10PW	CLR-15S
TTPR/L10	LRIS-4*10PW	CLR-15S
TTPR/L12**	LRIS-4*12PW	CLR-15S
TTPR/L16**	LRIS-4*12PW	CLR-15S
TTPR/L20**	LRIS-4*10	LLR-25S-20*65

TTP-F

Shifted

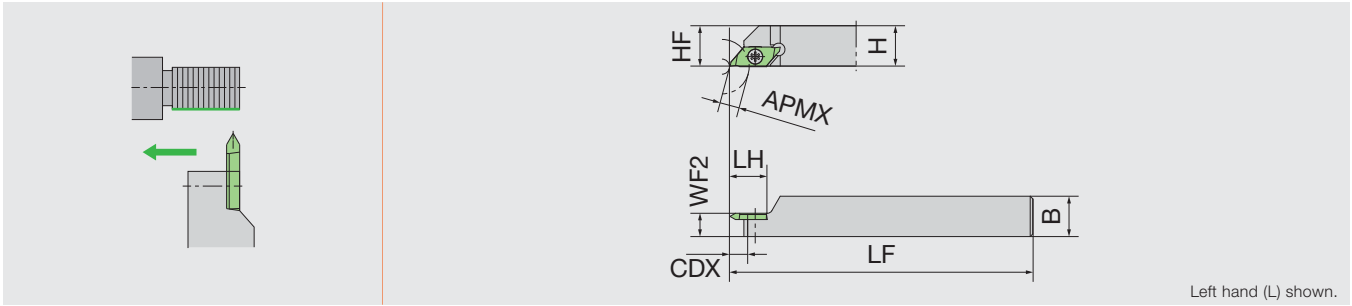

Designation	Pitch	H	B	LF	LH	APMX	CDX	HF	WF	WF2	Insert
TTPL12-F06	0.2 - 1.5	12	12	120	16	6.5	5.5	12	7.25	-	TTP..
TTPL16-F08	0.2 - 1.5	16	16	120	16	6.5	5.5	16	9.25	-	TTP..

SPARE PARTS



Designation	Clamp screw	Wrench (for Clamp screw)
TTPL**	LRIS-4*6	LLR-25S

CH-TTP

For horizontal gang style tool post

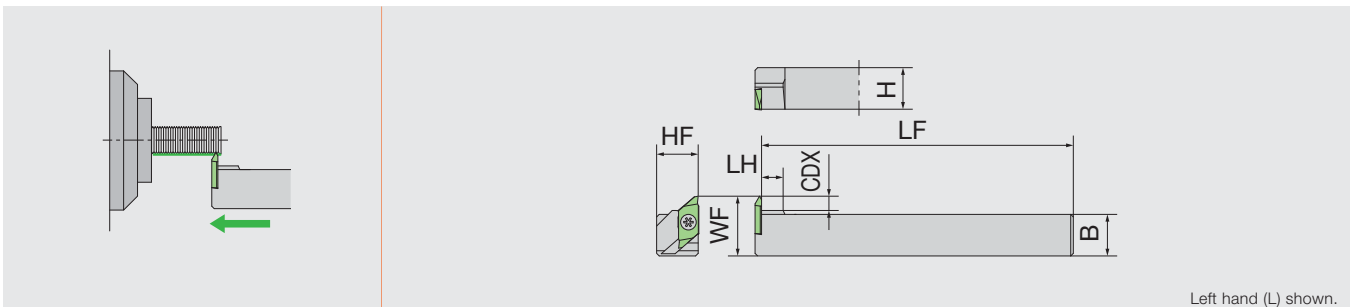

Designation	Pitch	H	B	LF	LH	CDX	HF	WF	Insert
CH-TTPL16	0.2 - 1.5	16	16	120	9	5.5	16	23	TTP..
CH-TTPL20	0.2 - 1.5	20	20	120	9	5.5	20	27	TTP..

NOTE: Use a right-handed (R) insert.

SPARE PARTS



Designation	Clamp screw	Wrench (for Clamp screw)
CH-TTPL**	LRIS-4*10	LLR-25S

DS-TTP

DS Toolholders / For sleeve tool post

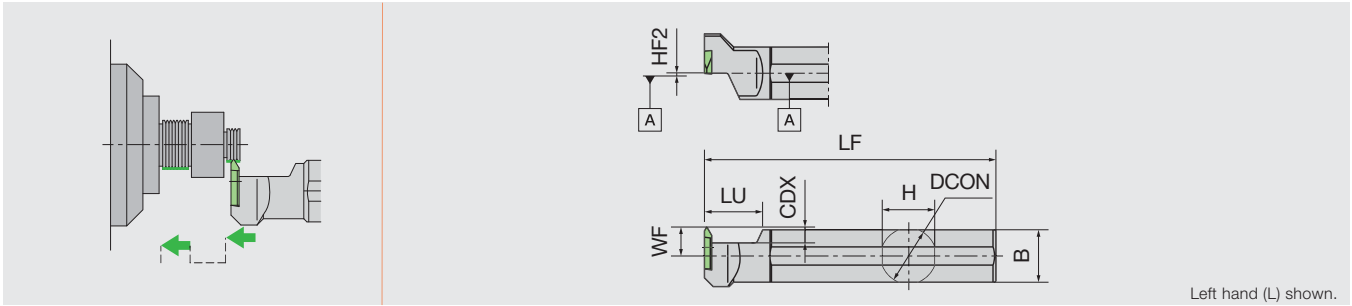

Designation	Pitch	H	B	LF	CDX	DCON	HF2	LU	WF	Insert
DS-TTPL16F	0.2 - 1.5	15	15	80	5.5	16	0	20	10	TTP..
DS-TTPL19	0.2 - 1.5	18	18	120	5.5	19.05	0	20	10	TTP..
DS-TTPL20	0.2 - 1.5	19	19	120	5.5	20	0	20	10	TTP..
DS-TTPL22	0.2 - 1.5	21	21	120	5.5	22	0	20	10	TTP..
DS-TTPL25	0.2 - 1.5	24	24	150	5.5	25.4	0	20	10	TTP..
DS-TTPL25-MET	0.2 - 1.5	24	24	150	5.5	25	0	20	10	TTP..

NOTE: Use a right-handed (R) insert.

SPARE PARTS



Designation	Clamp screw	Wrench (for Clamp screw)
DS-TTPL**	LRIS-4*10	LLR-25S-20*65

INSERT

TTP-R

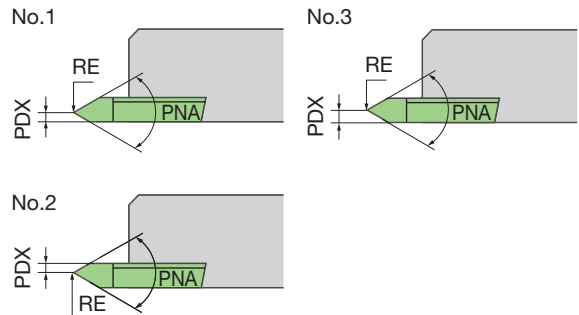
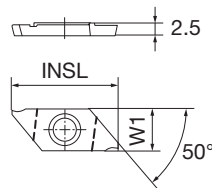

	P Steel	M Stainless	N Non-ferrous	S Superalloys	H Hard materials
★	★	☆	☆	★	★
☆	☆	★	★	☆	☆

★ : First choice
☆ : Second choice

Designation	HAND	Coated		Uncoated	Pitch	TPI	PNA	PDX	INSL	W1	RE	Figure
		QM3	ZM3	KM1								
TTP60FR2A	R		●		0.2 - 0.35	127 - 72	60°	0.2	19.9	8	0.05MAX Flat	1
TTP60FR4A	R	●	●		0.2 - 0.75	127 - 34	60°	0.4	19.9	8	0.05MAX Flat	1
TTP60FR4AS	R			●	Ⓜ 0.2 - 0.75	127 - 34	60°	0.4	19.9	8	0.05MAX Flat	1
TTP60FR8A	R	●	●		0.4 - 1.25	63 - 21	60°	0.8	19.9	8	0.05	1
TTP60FR8AS	R			●	Ⓜ 0.4 - 1.25	63 - 21	60°	0.8	19.9	8	0.05	1
TTP55FR8A	R		●		-	48 - 16	55°	0.8	19.9	8	0.05	1
TTP60FR2B	R		●		0.2 - 0.35	127 - 72	60°	0.2	19.9	8	0.05MAX Flat	2
TTP60FR4B	R	●	●		0.2 - 0.75	127 - 34	60°	0.4	19.9	8	0.05MAX Flat	2
TTP60FR4BS	R			●	Ⓜ 0.2 - 0.75	127 - 34	60°	0.4	19.9	8	0.05MAX Flat	2
TTP60FR8B	R	●	●		0.4 - 1.25	63 - 21	60°	0.8	19.9	8	0.05	2
TTP60FR8BS	R			●	Ⓜ 0.4 - 1.25	63 - 21	60°	0.8	19.9	8	0.05	2
TTP55FR8B	R		●		-	48 - 16	55°	0.8	19.9	8	0.05	2
TTP60FR-N	R	●	●		1 - 1.5	25 - 17	60°	1.25	19.9	8	0.1	3
TTP60FR-NS	R			●	Ⓜ 1 - 1.5	25 - 17	60°	1.25	19.9	8	0.1	3
TTP60FR-N02	R	●	●		1.5 - 2	16 - 13	60°	1.25	19.9	8	0.2	3

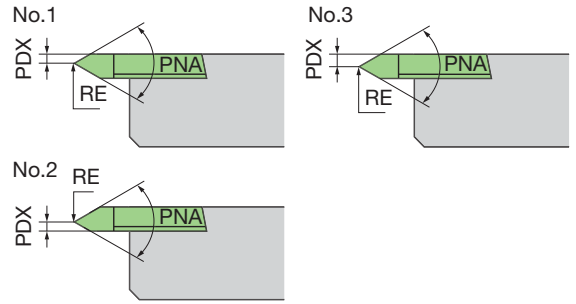
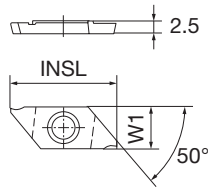

P	Steel	★	☆		
M	Stainless	☆	★		
N	Non-ferrous		☆	★	
S	Superalloys	☆			
H	Hard materials	★			

★ : First choice
☆ : Second choice

Designation	HAND	Coated			Uncoated			Pitch	TPI	PNA	PDX	INSL	W1	RE	Figure
		QM3	ZM3	KM1											
TTP60FL2A	L		●				0.2 - 0.35	127 - 72	60°	0.2	19.9	8	0.05MAX Flat	1	
TTP60FL4A	L	●	●				0.2 - 0.75	127 - 34	60°	0.4	19.9	8	0.05MAX Flat	1	
TTP60FL4AS	L			●	Ⓜ		0.2 - 0.75	127 - 34	60°	0.4	19.9	8	0.05MAX Flat	1	
TTP60FL8A	L	●	●				0.4 - 1.25	63 - 21	60°	0.8	19.9	8	0.05	1	
TTP60FL8AS	L			●	Ⓜ		0.4 - 1.25	63 - 21	60°	0.8	19.9	8	0.05	1	
TTP55FL8A	L		●				-	48 - 16	55°	0.8	19.9	8	0.05	1	
TTP60FL2B	L		●				0.2 - 0.35	127 - 72	60°	0.2	19.9	8	0.05MAX Flat	2	
TTP60FL4B	L	●	●				0.2 - 0.75	127 - 34	60°	0.4	19.9	8	0.05MAX Flat	2	
TTP60FL4BS	L			●	Ⓜ		0.2 - 0.75	127 - 34	60°	0.4	19.9	8	0.05MAX Flat	2	
TTP60FL8B	L	●	●				0.4 - 1.25	63 - 21	60°	0.8	19.9	8	0.05	2	
TTP60FL8BS	L			●	Ⓜ		0.4 - 1.25	63 - 21	60°	0.8	19.9	8	0.05	2	
TTP55FL8B	L		●				-	48 - 16	55°	0.8	19.9	8	0.05	2	
TTP60FL-N	L	●	●				1 - 1.5	25 - 17	60°	1.25	19.9	8	0.1	3	
TTP60FL-NS	L			●	Ⓜ		1 - 1.5	25 - 17	60°	1.25	19.9	8	0.1	3	
TTP60FL-N02	L	●	●				1.5 - 2	16 - 13	60°	1.25	19.9	8	0.2	3	

● : Line up

General Information

Right Hand Toolholders				Left Hand Toolholders			
Guide bushing side		Sub spindle side / Part shoulder		Guide bushing side		Sub spindle side / Part shoulder	
<p>Edge Shape : A type</p>		<p>Edge Shape : B type</p>		<p>Edge Shape : B type</p>		<p>Edge Shape : A type</p>	
Toolholder	TTPR	Toolholder	TTPR	Toolholder	TTPL	Toolholder	TTPL
Insert	TTP..FR..A	Insert	TTP..FR..B	Insert	TTP..FL..B	Insert	TTP..FL..A

Grade
Insert
Ext. Toolholder
Int. Toolholder
Threading
Grooving
Shaper
Endmill
Drilling Tool
Technical Reference

Parting-off toolholders with high pressure coolant capability, for swiss lathes

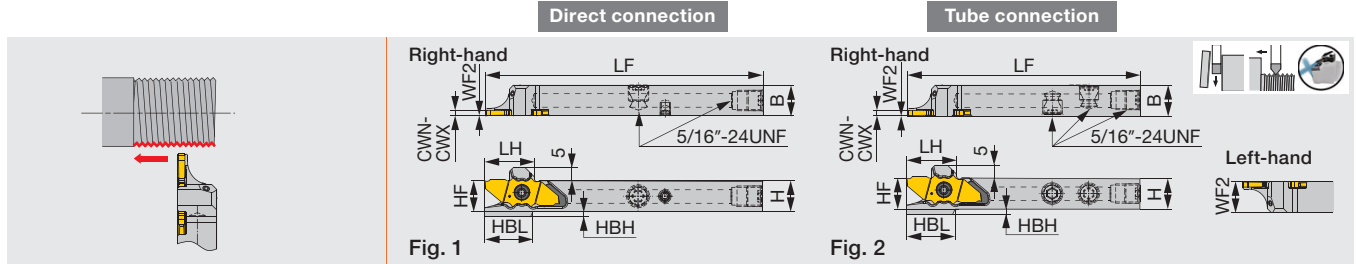

Designation	CWN	CWX	H	B	LF ⁽¹⁾	LH ⁽¹⁾	HF	WF2 ⁽²⁾	HBL ⁽¹⁾	HBH	Insert	Torque*	Fig.
JSXXR/L1012H09-CHP ⁽³⁾	0.6	2.5	10	12	102	19.2	10	0.2/11.8	18.7	3	JX**06...,12...,16..., 20...	1.2	1
JSXXR/L1212F09-CHP	0.6	2.5	12	12	85	19.4	12	0.2/11.8	18.8	2	JX**06...,12...,16..., 20...	1.2	2
JSXXR/L1212X09-CHP ⁽³⁾	0.6	2.5	12	12	120	19.4	12	0.2/11.8	18.8	2	JX**06...,12...,16..., 20...	1.2	1
JSXXR/L1616X09B-CHP ⁽³⁾	0.6	2.5	16	16	120	19.4	16	0.2/15.8	18.7	-	JX**06...,12...,16..., 20...	1.2	1

Torque*: Recommended clamping torque (N·m)
 (1) LF (Functional Length) LH (Head Length), and HBL (Head-bottom Offset Length) values shown above are true with JX**16... insert. LF, LH, and HBL will all be 2 mm shorter than the above values with JX**12... and JX**20... inserts, and 4 mm shorter for JX**06... insert.
 (2) The first value before "/" indicates the WF for the right-hand holder and the second value after "/" for the left-hand holder.
 (3) Compatible to the direct internal coolant supply system without the use of external coolant hose.
 (4) To be replaced with the new design
 Note: Use the right-hand insert (JX***R...) for a right-hand holder (JSXXR...); the left-hand insert (JX***L...) for a left-hand holder (JSXXL...).

SPARE PARTS

Designation	Clamping screw	Wrench 1	Coolant plug	Wrench 2	DirectJet plug	Wrench 3
JSXXR**F...	CSTC-4L100DL	T-1008/5	SR5/16UNFTL360	P-4	-	-
JSXXL**F...	CSTC-4L100DR	T-1008/5	SR5/16UNFTL360	P-4	-	-
JSXXR**H/X...	CSTC-4L100DL	T-1008/5	SR5/16UNFTL360	P-4	SSHM4-6-TB	P-2
JSXXL**H/X...	CSTC-4L100DR	T-1008/5	SR5/16UNFTL360	P-4	SSHM4-6-TB	P-2

JSXXR/L-F/X-S-CHP

Parting-off toolholders with high pressure coolant capability, for swiss lathes (for sub spindle)

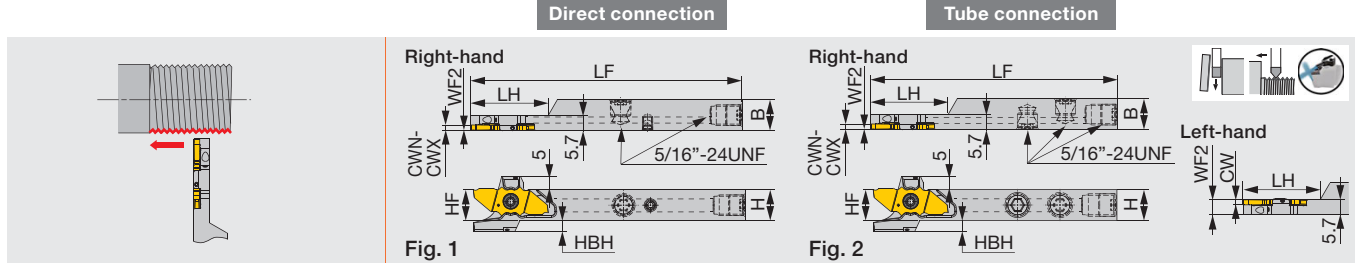

Designation	CWN	CWX	H	B	LF ⁽¹⁾	LH ⁽¹⁾	HF	WF2 ⁽²⁾	HBH	Insert	Torque*	Fig.
JSXXR1212F09-S-CHP ⁽⁴⁾	0.6	2.5	12	12	85	26	12	0.2	4	JX**06...,12...,16..., 20...	1.2	2
JSXXR/L1212F09B-S-CHP	0.6	2.5	12	12	85	30	12	0.2/5.5	2	JX**06...,12...,16..., 20...	1.2	2
JSXXR/L1212X09-S-CHP ^{(3),(4)}	0.6	2.5	12	12	120	30	12	0.2/5.5	4	JX**06...,12...,16..., 20...	1.2	1
JSXXR/L1212X09B-S-CHP ⁽³⁾	0.6	2.5	12	12	120	30	12	0.2/5.5	2	JX**06...,12...,16..., 20...	1.2	1
JSXXR1616X09-S-CHP ^{(3),(4)}	0.6	2.5	16	16	120	30	16	0.2	1.5	JX**06...,12...,16..., 20...	1.2	1
JSXXR/L1616X09B-S-CHP ⁽³⁾	0.6	2.5	16	16	120	30	16	0.2/5.5	-	JX**06...,12...,16..., 20...	1.2	1

Torque*: Recommended clamping torque (N·m)
 (1) LF (Functional Length) and LH (Head Length) values shown above are true with JX**16... insert. Both LF and LH will be 2 mm shorter than the above value with JX**12... and JX**20... inserts; 4 mm shorter with JX**06... insert.
 (2) The first value before "/" indicates the WF for the right-hand holder and the second value after "/" for the left-hand holder.
 (3) Compatible to the direct internal coolant supply system without the use of external coolant hose.
 (4) To be replaced with the new design
 Note: Use the right-hand insert (JX***R...) for a right-hand holder (JSXXR...); the left-hand insert (JX***L...) for a left-hand holder (JSXXL...).

SPARE PARTS

Designation	Clamping screw	Wrench 1	Coolant plug	Wrench 2	DirectJet plug	Wrench 3
JSXXR**F...	CSTC-4L100DL	T-1008/5	SR5/16UNFTL360	P-4	-	-
JSXXL**F...	CSTC-4L100DR	T-1008/5	SR5/16UNFTL360	P-4	-	-
JSXXR**H/X...	CSTC-4L100DL	T-1008/5	SR5/16UNFTL360	P-4	SSHM4-6-TB	P-2
JSXXL**H/X...	CSTC-4L100DR	T-1008/5	SR5/16UNFTL360	P-4	SSHM4-6-TB	P-2

Reference pages: Inserts → 5-12

Round shanks, for threading

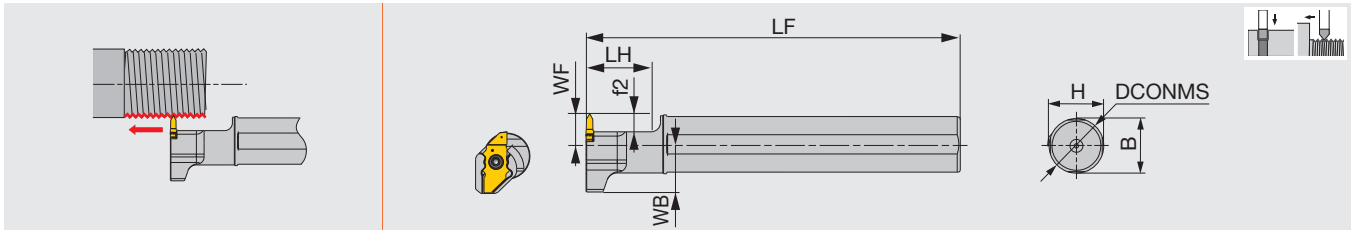

Designation	DCONMS	H	B	LF	LH	WB	WF ⁽¹⁾	f2 ⁽¹⁾	Insert	Torque*
JS19G-SXXL09	19.05	18	18	90	21	15.43	10	6	JX**06,12*R	1.2
JS19X-SXXL09	19.05	18	18	120	21	15.43	10	6	JX**06,12*R	1.2
JS20G-SXXL09	20	19	19	90	21	15.4	10	6	JX**06,12*R	1.2
JS20X-SXXL09	20	19	19	120	21	15.4	10	6	JX**06,12*R	1.2
JS22X-SXXL09	22	21	21	120	21	15.4	10	6	JX**06,12*R	1.2
JS25H-SXXL09	25	24	24	100	21	15.4	10	6	JX**06,12*R	1.2
JS254X-SXXL09	25.4	24	24	120	21	15.4	10	6	JX**06,12*R	1.2

Torque*: Recommended clamping torque (N·m)

(1) When using JX..06... insert, both WF and f2 sizes will be 2 mm shorter than the values provided above.

SPARE PARTS

Designation	Clamping screw	Wrench
JS***-SXXL09	CSTC-4L100DL	T-1008/5

QR12-SXXL-CHP

Modular head for external grooving and threading, with high pressure coolant capability

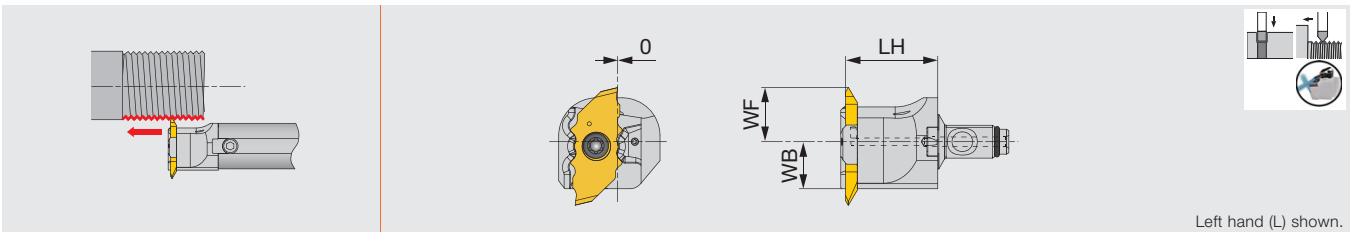

Designation	LH	WF ⁽¹⁾	WB	Insert	Torque*	Shank
QR12E-SXXL09-CHP	19.5	11.5	8	JX*G**R...	1.2	A16*-QR12
QR12G-SXXL09-CHP	19.5	13.5	10	JX*G**R...	1.2	A19/20*-QR12

Use left-hand toolholders (L) with right-hand inserts (R).

Torque*: Recommended clamping torque (N·m)

(1) WF (Functional Width) values shown above are true with JX**16... insert. WF will be 2 mm shorter than the above value with JX**12... insert; 4 mm shorter with JX**06... insert; 2 mm longer with JX**20... insert.

Assembled dimensions with shank are shown on page 9.

SPARE PARTS

Designation	Clamping screw	Wrench	O-ring
QR12*-SXXL09-CHP	CSTC-4L100DL	T-1008/5	ORSS-0454.5X1.0NBR70

STANDARD CUTTING CONDITIONS

ISO	Workpiece materials	Grades	Cutting speed Vc (m/min)
P	Low carbon steels S15C, SS400, etc. C15E4, E275A, etc.	SH725	50 - 200
	Carbon steels, Alloy steels S55C, SCM440, etc. C55, 42CrMo4, etc.	SH725	50 - 200
	Free cutting steels SUH22, SUH23, etc.	SH725	50 - 200
M	Stainless steels SUS304, X5CrNi18-9, etc.	SH725	50 - 200
N	Aluminium alloys A5056, A6061, etc.	SH725	150 - 200
	Copper alloy C2600, C280C, etc.	SH725	100 - 200
S	Titanium alloys Ti-6Al-4V, etc.	SH725	30 - 80
	Superalloys Inconel718, etc.	SH725	30 - 80

Screw-on external threading toolholders

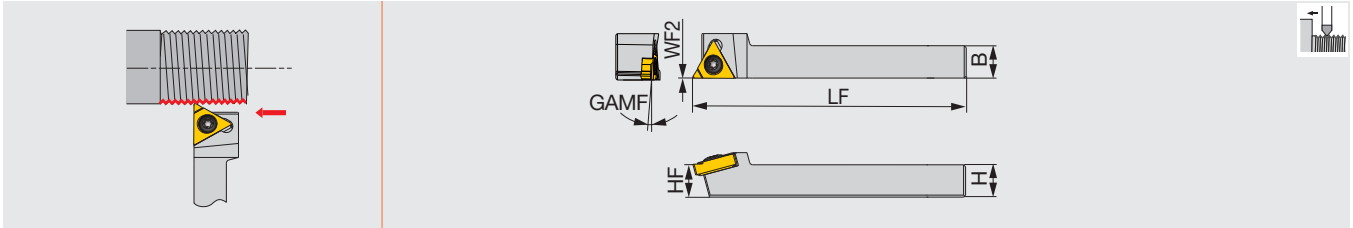

Designation	H	B	LF	HF	WF2	GAMF	Insert
SER0808H11	8	8	100	8	0	1.5°	11ER...
SER1010H11	10	10	100	10	0	1.5°	11ER...

SPARE PARTS



Designation	Clamping screw	Wrench 1
SER**H11	SR M2.6-L6.7-S11	T-8/5

JSE2R16-CHP

Screw-on external threading toolholders-High-pressure coolant capability with tube and direct connection

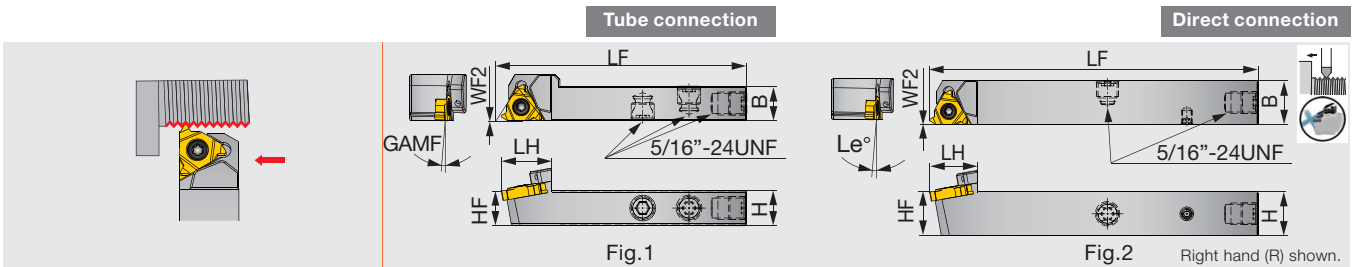

Designation	H	B	LF	LH	HF	WF2	GAMF	Insert	Fig.
JSE2R1212F16-CHP	12	12	85	19	12	0	1°	16ER...	1
JSE2R1212X16-CHP	12	12	120	19	12	0	1°	16ER...	2
JSE2R1616X16-CHP	16	16	120	19	16	0	1°	16ER...	2

SPARE PARTS



Designation	Clamping screw	Wrench	Coolant plug	Wrench
JSE2R**16-CHP	CSTB-3.5	T-15F	SR5/16UNFTL360	P-4

CER/L

External threading toolholder, alternative clamping of screw-on or clamp-on only for DT type

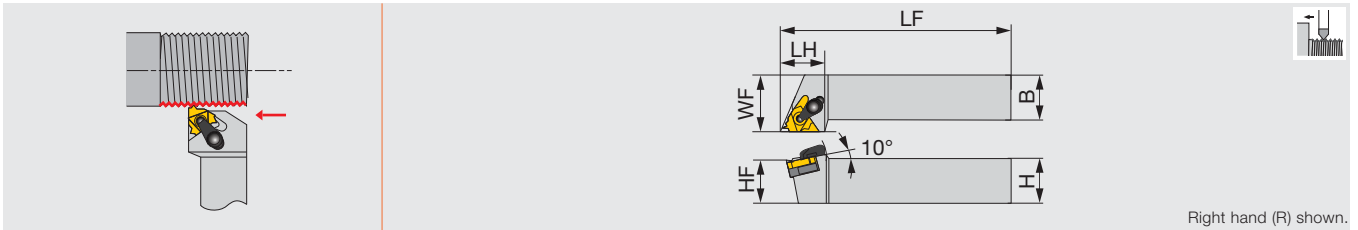

Designation	H	B	LF	LH	HF	WF	Insert
CER/L1212H16DT	12	12	100	24	12	16	16ER/L...
CER/L1616H16DT	16	16	100	24	16	20	16ER/L...
CER/L2020K16DT	20	20	125	24	20	25	16ER/L...

Note: A clamp set consists of a clamp and a clamping screw. A shim set consists of a shim and a shim screw to secure the shim to the shank. Standard shims can be used on both right- and left-hand toolholders. Please use either of the sides depending on the tool hand. When using DT type, please remove either the clamp set or the insert clamping screw.

SPARE PARTS						
Designation	Clamp set	Clamping screw	Shim screw	Shim	Wrench 1	Wrench 2
CER/L**16DT	CSP16	CSTB-3.5ST	DTS5-3.5	A16-1DT	P-3.5	T-15F

JS-SEL16

External threading toolholder, for Swiss lathes

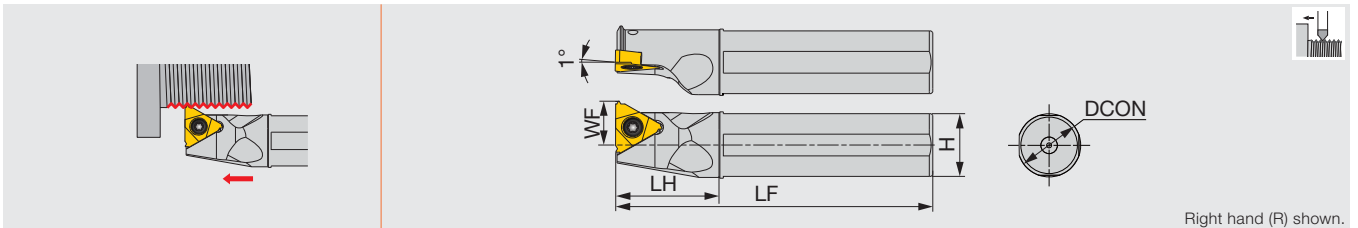

Designation	DCON	H	LF	LH	WF	Insert
JS16F-SEL16	16	15	85	25	11	16ER...
JS19G-SEL16	19.05	18	90	30	12.5	16ER...
JS19X-SEL16	19.05	18	120	30	12.5	16ER...
JS20G-SEL16	20	19	90	30	13	16ER...
JS20X-SEL16	20	19	120	30	13	16ER...
JS25H-SEL16	25	24	100	30	15.5	16ER...
JS254X-SEL16	25.4	24	120	30	15.7	16ER...

Note: Use left-hand toolholders (L) with right-hand inserts (R).

SPARE PARTS		
Designation	Clamping screw	Wrench
JS***-SEL16, B-SER**16	CSTB-3.5	T-15F

Reference pages: Inserts → 5-10 -, Standard cutting conditions → 5-43

Grade

Insert

Ext. Toolholder

Int. Toolholder

Threading

Grooving

Shaper

Endmill

Drilling Tool

Technical Reference

SIR

Internal threading bars, Screw-on clamp

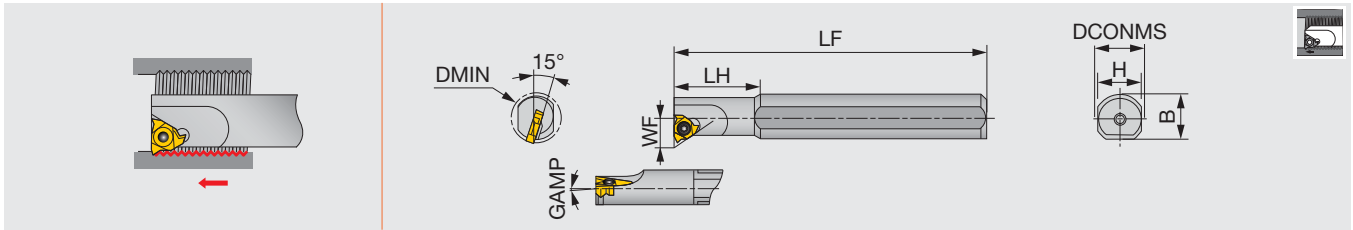

Designation	Material	DMIN	DCONMS	WF	LF	LH	H	B	GAMP	Coolant hole	Insert
SIR0005H06	STEEL	6.4	12	4.3	100	12	11	-	1.5°	Without	06IR...
SIR0007K08	STEEL	8	16	5.3	125	18	15	-	1.5°	Without	08IR...
SIR0005H06CB	CARBIDE	6.4	6	4.3	100	25	5	-	1.5°	With	06IR...
SIR0007K08CB	CARBIDE	7.8	8	5.3	125	30	7	-	1.5°	With	08IR...

Note: Use the right-hand insert (**IR...) for a right-hand holder (SIR...).
Recommend over 1 mm clearance between internal diameter of thread and each tools DMIN.

Applicable thread size

Description	ISO metric	Unified IRA60 Insert	Parallel pipe IRA55 Insert
SIR0005H06...	≥ M9	≥ 3/8-24 UNF	≥ G1/8
SIR0007K08...	≥ M11	≥ 7/16-20 UNF	≥ G1/4

SNR-2/3

Screw-on internal threading toolholder

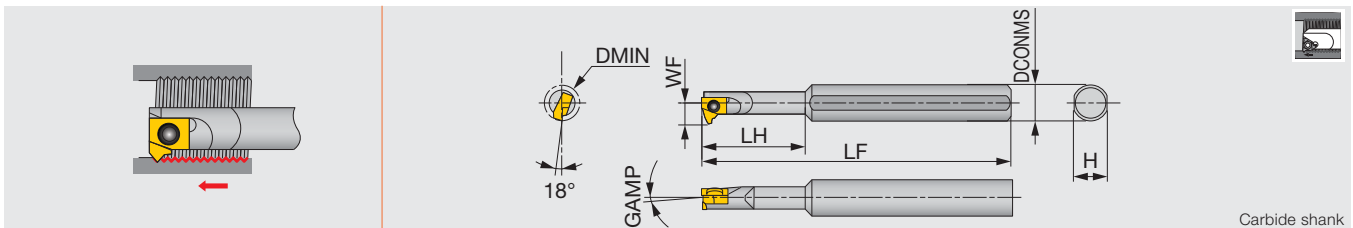

Designation	Material	DMIN	DCONMS	WF	LF	LH	H	GAMP	Insert
SNR0006H06-2	Steel	8	8	4.7	100	18	7	2°	6IR...
SNR0006H06-3	Steel	8	8	4.7	100	18	7	3°	6IR...
SNR0008H06-2	Steel	10	8	5.7	100	18	7	2°	6IR...
SNR0008H06-3	Steel	10	8	5.7	100	18	7	3°	6IR...
SNR0006K06SC-2	Carbide	8	8	4.7	125	30	7	2°	6IR...
SNR0006K06SC-3	Carbide	8	8	4.7	125	30	7	3°	6IR...
SNR0008K06SC-2	Carbide	10	8	5.7	125	18	7	2°	6IR...
SNR0008K06SC-3	Carbide	10	8	5.7	125	18	7	3°	6IR...

Note: Use the right-hand insert (6IR...) for a right-hand holder (SNR...).

SPARE PARTS



Designation	Clamping screw	Wrench
SIR0005H06...	SR 14-552	T-6F-S
SIR0007K08...	SR 14-558	T-6F-S
SNR0006H06...	CSTB-2L040	T-6F
SNR0008H06...	CSTB-2L	T-6F
SNR0006K06SC...	CSTB-2L040	T-6F
SNR0008K06SC...	CSTB-2L	T-6F

Reference pages: SIR : Inserts → 5-10, 5-13, 5-14
SNR-2/3 : Inserts → 5-10, 5-13, 5-14, 5-22

STANDARD CUTTING CONDITIONS

TUNGTHREAD

ISO	Workpiece material	Hardness	Cutting speed: Vc (m/min)						
			AH8015	T05HP	AH725	T313V	NS9530	TH10	BX330
P	Steel / Alloy steel S45C, SCM440, etc. C45, 42CrMoS4, etc.	< 200HB	80 - 180	100 - 200	80 - 180	100 - 200	150 - 200	-	-
		> 200HB	60 - 160	100 - 150	60 - 160	100 - 150	100 - 170	-	-
M	Stainless steel SUS304, etc. X5CrNi18-9, etc.	-	50 - 130	70 - 130	50 - 130	70 - 130	-	-	-
K	Cast iron FC250, FC300, etc. 250, 300, etc.	-	60 - 150	70 - 150	50 - 100	70 - 150	-	70 - 90	-
N	Non-ferrous metal	-	-	-	-	-	100 - 500	-	-
S	Superalloys Ti-6Al-4V, Inconel718, etc.	-	20 - 80	-	-	-	10 - 40	-	-
H	Hardened steel	50 - 60HRC	-	-	-	-	10 - 30	50 - 200	-

TINYCUT^{INTERNAL} A/E-SMR

Screw-on boring bar

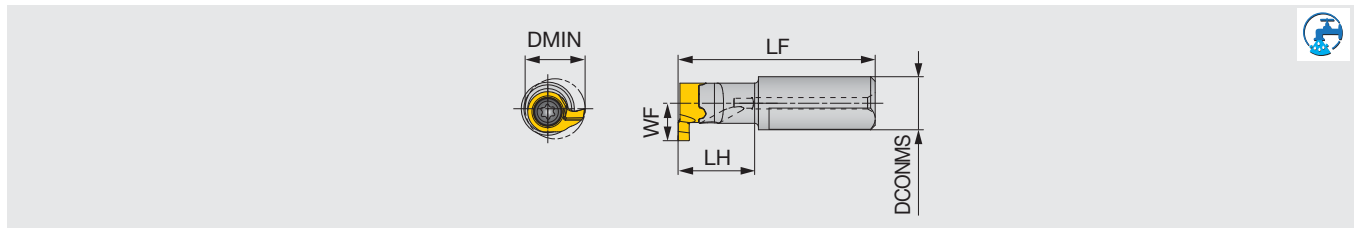

Designation	Material	DCONMS	LH	LF	Insert	Torque*
A07080-SMR4	Steel	7	8	24	M*R4...	0.5
E07120-SMR4	Carbide	7	12	29	M*R4...	0.5
A07100-SMR5	Steel	7	10	26	M*R5...	1.3
E07180-SMR5	Carbide	7	18	34	M*R5...	1.3

SPARE PARTS

Designation	Clamping screw	Wrench
A/E07**-SMR4	CSPB-1.8L3.6	IP-6F
A/E07**-SMR5	CSTB-2.5L054DR	T-7F

*Torque: Recommended clamping torque (N·m)
 For A/E-SMR4, the above LF and LH dimensions are true with MGR4100F000-D05 insert assembled.
 For A/E-SMR5, the above LF and LH dimensions are true with MGR5150F003-D07 insert assembled.
 The DMIN and WF sizes vary depending on the insert sizes used.

INSERT

MTR

Threading

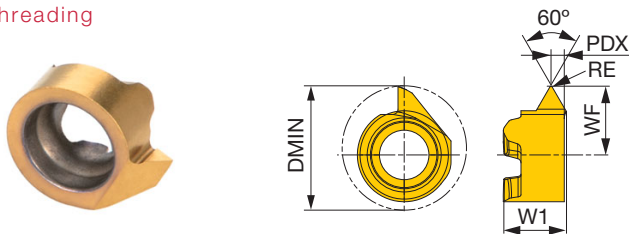

P Steel	★									
M Stainless	★									
K Cast iron	★									
N Non-ferrous										
S Superalloys	★									
H Hard materials										

★ : First choice

Designation	RE	Coated								Pitch min	Pitch max	DMIN	PDX	WF	W1
		SH7025													
MTR460F003-D05	0.03	●								0.5	0.75	5	0.65	2.9	2.1
MTR560F007-D07	0.07	●								1	1.25	7	0.9	3.9	3.6

●: Line up

Grade

Insert

Ext. Toolholder

Int. Toolholder

Threading

Grooving

Shaper

Endmill

Drilling Tool

Technical Reference

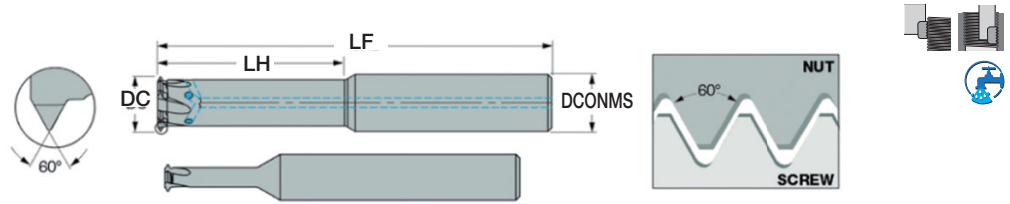

Designation	ISO Metric				Unified				DCONMS	DC	NOF	LH	LF	Coolant hole	Grade	
	Internal		External	Internal		External	min.	max.								
	Pitch	Application range	Pitch	TPI	Application range	TPI										
min.	max.	min.	max.	min.	max.	min.	max.									
MTECI03019C5A60	0.35	0.6	≥M2.5x0.35 ≥M2.5x0.4 ≥M2.5x0.45 ≥M3x0.5 ≥M3x0.6	0.35	0.6	40	72	≥#3-72UN ≥#3-64UN ≥#3-56UN ≥#3-48UN ≥#4-44UN ≥#4-40UN	40	72	3	1.9	3	5.2	39	Without AH710
MTECI06032C9A60	0.5	1.0	≥M4x0.5 ≥M4x0.6 ≥M4x0.7 ≥M4.5x0.75 ≥M4.5x0.8 ≥M5x1	0.5	1.0	24	48	≥#8-48UN ≥#8-44UN ≥#8-40UN ≥#8-36UN ≥#8-48UN ≥#10-28UN ≥#10-24UN	24	48	6	3.2	3	9.5	57	Without AH710
MTECI0604C12A60	0.5	1.0	≥M5x0.5 ≥M5x0.6 ≥M5x0.7 ≥M5x0.75 ≥M5x0.8 ≥M6x1	0.5	1.0	24	48	≥#10-48UN ≥#10-44UN ≥#10-40UN ≥#10-36UN ≥#12-32UN ≥#12-28UN ≥#12-24UN	24	48	6	4	3	12.5	58	Without AH710
MTECI0605D20A60	0.5	0.8	≥M6	0.4	0.8	28	56	≥M1/4	32	64	6	5	4	20	58	With AH725
MTECI0808D28A60	0.5	0.8	≥M9	0.4	0.8	28	56	≥M3/8	32	64	8	8	4	28	64	With AH725
MTECI0808D30A60	1.0	1.75	≥M10	0.8	1.5	14	28	≥M7/16	16	32	8	8	4	30	64	With AH725
MTECI1010D35A60	1.0	1.75	≥M12	0.8	1.5	14	28	≥M1/2	16	32	10	10	4	35	73	With AH725
MTECI1212E40A60	2.0	3.0	≥M16	1.75	2.5	8	13	≥M11/16	10	15	12	12	5	40	84	With AH725
MTECI1616E50A60	2.0	3.0	≥M20	1.75	2.5	8	13	≥M13/16	10	15	16	16	5	50	101	With AH725

ISO metric (M)

MTECI-ISO

Solid carbide internal threading endmill, for ISO metric profile

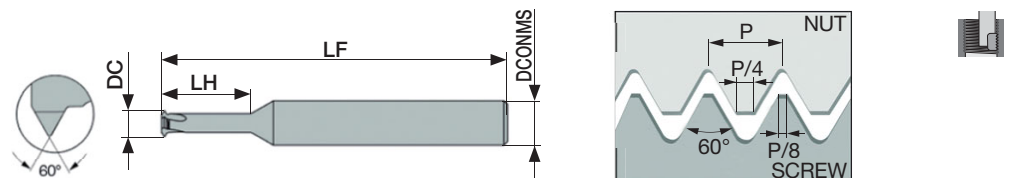

Designation	Pitch	Application range	DCONMS	DC	NOF	LH	LF	Coolant hole	Grade
MTECI03007C30.25ISO	0.25	≥M1	6	0.72	3	3.6	39	Without	AH710
MTECI03009C40.25ISO	0.25	≥M1.2	6	0.9	3	4.3	39	Without	AH710
MTECI03011C50.3ISO	0.3	≥M1.4	6	1.05	3	5.0	39	Without	AH710
MTECI03012C60.35ISO	0.35	≥M1.6	6	1.2	3	5.7	39	Without	AH710
MTECI03016C70.4ISO	0.4	≥M2	6	1.55	3	7.1	39	Without	AH710
MTECI03024C100.5ISO	0.5	≥M3	6	2.37	3	10.6	39	Without	AH710

Reference pages: Standard cutting conditions → [5-50](#) - [5-51](#)

MTECS-ISO

Small diameter solid carbide internal threading endmill, short edge type, for ISO metric profile

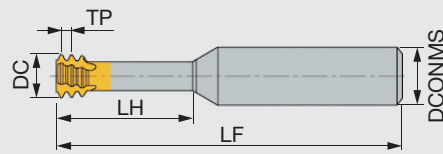

Designation	TP	Application range	DCONMS	DC	NOF	LH	LF	Coolant hole	Grade
MTECS03007C20.25ISO	0.25	≥M1	3	0.72	3	2.5	39	Without	AH725
MTECS03009C30.25ISO	0.25	≥M1.2	3	0.9	3	3	39	Without	AH725
MTECS03011C40.3ISO	0.3	≥M1.4	3	1.05	3	4	39	Without	AH725
MTECS03012C50.35ISO	0.35	≥M1.6	3	1.2	3	4.8	39	Without	AH725
MTECS03016C60.4ISO	0.4	≥M2	3	1.53	3	6	39	Without	AH725
MTECS06016C40.4ISO	0.4	≥M2	6	1.53	3	4.5	58	Without	AH725
MTECS03017C70.45ISO	0.45	≥M2.2	3	1.65	3	7	39	Without	AH725
MTECS06017C50.45ISO	0.45	≥M2.2	6	1.65	3	5	58	Without	AH725
MTECS0602C50.45ISO	0.45	≥M2.5	6	1.95	3	5.5	58	Without	AH725
MTECS0602C70.45ISO	0.45	≥M2.5	6	1.95	3	7.5	58	Without	AH725
MTECS06024C60.5ISO	0.5	≥M3	6	2.37	3	6.5	58	Without	AH725
MTECS06024C90.5ISO	0.5	≥M3	6	2.37	3	9.5	58	Without	AH725
MTECS06024C90.5ISOL	0.5	≥M3	6	2.37	3	9.5	105	Without	AH725
MTECS03024C120.5ISO	0.5	≥M3	3	2.4	3	12.5	39	Without	AH725
MTECS03024C150.5ISO	0.5	≥M3	3	2.4	3	15.5	39	Without	AH725
MTECS06054D200.5ISO	0.5	≥M6	6	5.35	4	20	58	Without	AH725
MTECS06028C100.6ISO	0.6	≥M3.5	6	2.75	3	10.5	58	Without	AH725
MTECS06028C70.6ISO	0.6	≥M3.5	6	2.75	3	7.5	58	Without	AH725
MTECS06031C120.7ISO	0.7	≥M4	6	3.1	3	12.5	58	Without	AH725
MTECS06031C120.7ISOL	0.7	≥M4	6	3.1	3	12.5	105	Without	AH725
MTECS06031C160.7ISO	0.7	≥M4	6	3.1	3	16.7	58	Without	AH725
MTECS06031C90.7ISO	0.7	≥M4	6	3.1	3	9	58	Without	AH725
MTECS0808D250.75ISO	0.75	≥M10	8	8	4	25	64	Without	AH725
MTECS06038C120.8ISO	0.8	≥M5	6	3.8	3	12.5	58	Without	AH725
MTECS06038C160.8ISO	0.8	≥M5	6	3.8	3	16	58	Without	AH725
MTECS06038C160.8ISOL	0.8	≥M5	6	3.8	3	16	105	Without	AH725
MTECS06047C141.0ISO	1	≥M6	6	4.65	3	14	58	Without	AH725
MTECS06047C201.0ISO	1	≥M6	6	4.65	3	20	58	Without	AH725
MTECS06047C201.0ISOL	1	≥M6	6	4.65	3	20	105	Without	AH725
MTECS0606C181.25ISO	1.25	≥M8	6	6	3	18	58	Without	AH725
MTECS0606C241.25ISO	1.25	≥M8	6	6	3	24	58	Without	AH725
MTECS08078C231.5ISO	1.5	≥M10	8	7.8	3	23	64	Without	AH725
MTECS08078C311.5ISO	1.5	≥M10	8	7.8	3	31.5	64	Without	AH725
MTECS1009C261.75ISO	1.75	≥M12	10	9	3	26	73	Without	AH725
MTECS12118D352.0ISO	2	≥M16	12	11.8	4	35	84	Without	AH725
MTECS12118D502.0ISO	2	≥M16	12	11.8	4	50	105	Without	AH725

Reference pages: Standard cutting conditions → 5-50 - 5-51

Grade
Insert
Ext. Toolholder
Int. Toolholder
Threading
Grooving
Shaper
Endmill
Drilling Tool
Technical Reference

Small diameter solid carbide internal threading endmill, short edge type, left hand cutting, for ISO metric profile

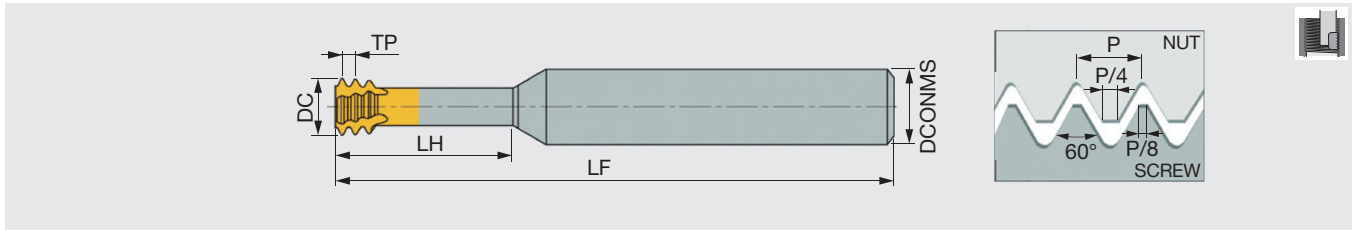

Designation	TP	Application range	DCONMS	DC	NOF	LH	LF	Coolant hole	Grade
MTECSH03012C50.35ISO	0.35	≥M1.6	3	1.2	3	4.8	39	Without	AH750
MTECSH03016C60.4ISO	0.4	≥M2	3	1.55	3	6	39	Without	AH750
MTECSH06016C40.4ISO	0.4	≥M2	6	1.55	3	4.5	58	Without	AH750
MTECSH06017C50.45ISO	0.45	≥M2.2	6	1.65	3	5	58	Without	AH750
MTECSH0602C50.45ISO	0.45	≥M2.5	6	1.95	3	5.5	58	Without	AH750
MTECSH0602C70.45ISO	0.45	≥M2.5	6	1.95	3	7.5	58	Without	AH750
MTECSH06024C60.5ISO	0.5	≥M3	6	2.35	3	6.5	58	Without	AH750
MTECSH06024C90.5ISO	0.5	≥M3	6	2.35	3	9.5	58	Without	AH750
MTECSH06028C70.6ISO	0.6	≥M3.5	6	2.75	3	7.5	58	Without	AH750
MTECSH06031C120.7ISO	0.7	≥M4	6	3.1	3	12.5	58	Without	AH750
MTECSH06038C120.8ISO	0.8	≥M5	6	3.8	3	12.5	58	Without	AH750
MTECSH06047C141.0ISO	1	≥M6	6	4.65	3	14	58	Without	AH750
MTECSH06047C201.0ISO	1	≥M6	6	4.65	3	20	58	Without	AH750
MTECSH0606C181.25ISO	1.25	≥M8	6	5.95	3	18	58	Without	AH750
MTECSH0606C241.25ISO	1.25	≥M8	6	5.95	3	24	58	Without	AH750
MTECSH08078C231.5ISO	1.5	≥M10	8	7.8	3	23	64	Without	AH750
MTECSH1009C261.75ISO	1.75	≥M12	10	9	3	26	73	Without	AH750
MTECSH12118D352.0ISO	2	≥M16	12	11.8	4	35	84	Without	AH750

MTECD-ISO

Small diameter solid carbide endmill for internal threading, drilling, and chamfering, short edge type, left hand cutting, for ISO metric profile

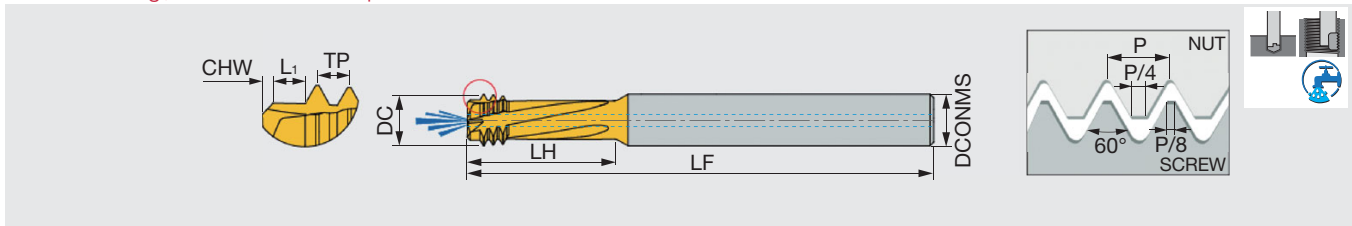

Designation	TP	Application range	DCONMS	DC	NOF	LH	LF	CHW	L1	Coolant hole	Grade
MTECD06032C110.7ISO	0.7	M4	6	3.15	3	11.6	58	0.2	0.7	Without	AH725
MTECD0604C140.8ISO	0.8	M5	6	4	3	14.4	58	0.3	0.8	Without	AH725
MTECD08047C141.0ISO	1	M6-M7	8	4.7	3	14	64	0.4	1	With	AH725
MTECD08061D181.25ISO	1.25	M8-M9	8	6.1	4	18	64	0.5	1.3	With	AH725
MTECD08078D231.5ISO	1.5	M10-M12	8	7.8	4	23	64	0.6	1.5	With	AH725
MTECD1009D261.75ISO	1.75	M12-M14	10	9	4	26	73	0.6	1.8	With	AH725
MTECD12118D352.0ISO	2	M16-M19	12	11.8	4	35	84	0.6	2	With	AH725

MTECS-UN

Small diameter solid carbide internal threading endmill, short edge type, for UN profile

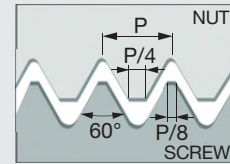
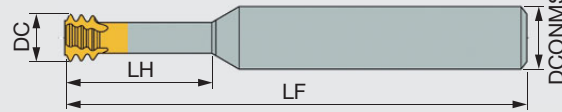

Designation	TPI	Application range	DCONMS	DC	NOF	LH	LF	Coolant hole	Grade
MTECS03012C880UN	80	≤ #0 (0.060)	3	1.15	3	8	39	Without	AH725
MTECS03015C672UN	72	≤ #1 (0.073)	3	1.45	3	6	39	Without	AH725
MTECS06016C656UN	56	≤ #2 (0.086)	6	1.65	3	6.6	58	Without	AH725
MTECS06016C456UN	56	≤ #2 (0.086)	6	1.65	3	4.4	58	Without	AH725
MTECS06019C548UN	48	≤ #3 (0.099)	6	1.9	3	5.2	58	Without	AH725
MTECS03021C1240UN	40	≤ #4 (0.112)	3	2.1	3	12	39	Without	AH725
MTECS06021C840UN	40	≤ #4 (0.112)	6	2.1	3	8	58	Without	AH725
MTECS06021C640UN	40	≤ #4 (0.112)	6	2.1	3	6.3	58	Without	AH725
MTECS06024C940UN	40	≤ #5 (0.125)	6	2.45	3	9.6	58	Without	AH725
MTECS06033C936UN	36	≤ #8 (0.164)	6	3.3	3	9	58	Without	AH725
MTECS06025C732UN	32	≤ #6 (0.138)	6	2.55	3	7.1	58	Without	AH725
MTECS06025C1032UN	32	≤ #6 (0.138)	6	2.55	3	10.5	58	Without	AH725
MTECS06032C932UN	32	≤ #8 (0.164)	6	3.2	3	9.5	58	Without	AH725
MTECS06032C1232UN	32	≤ #8 (0.164)	6	3.2	3	12.5	58	Without	AH725
MTECS06037C1032UN	32	≤ #10 (0.190)	6	3.7	3	10.5	58	Without	AH725
MTECS06037C1532UN	32	≤ #10 (0.190)	6	3.7	3	15	58	Without	AH725
MTECS0605C1428UN	28	≤ 1/4	6	5	3	14.5	58	Without	AH725
MTECS0605C1928UN	28	≤ 1/4	6	5	3	19	58	Without	AH725
MTECS08066C1724UN	24	≤ 5/16	8	6.6	3	17	64	Without	AH725
MTECS08066C2424UN	24	≤ 5/16	8	6.6	3	24	64	Without	AH725
MTECS06047C1420UN	20	≤ 1/4	6	4.75	3	14	58	Without	AH725
MTECS06047C1920UN	20	≤ 1/4	6	4.75	3	19	58	Without	AH725
MTECS06047C1920UN-L	20	≤ 1/4	6	4.75	3	19	105	Without	AH725
MTECS0808C2520UN	20	≤ 7/16	8	8	3	25	64	Without	AH725
MTECS0606C1718UN	18	≤ 5/16	6	6	3	17	58	Without	AH725
MTECS0606C2318UN	18	≤ 5/16	6	6	3	23	58	Without	AH725
MTECS1212D3518UN	18	≤ 5/8	12	12	4	35	84	Without	AH725
MTECS08067C2216UN	16	≤ 3/8	8	6.7	3	22	64	Without	AH725
MTECS08067C3016UN	16	≤ 3/8	8	6.7	3	30.2	64	Without	AH725
MTECS08077C2514UN	14	≤ 7/16	8	7.7	3	25	64	Without	AH725
MTECS10092C2713UN	13	≤ 1/2	10	9.2	3	27.5	73	Without	AH725
MTECS12114C3411UN	11	≤ 5/8	12	11.4	3	34.5	84	Without	AH725
MTECS12114C5011UN	11	≤ 5/8	12	11.4	3	50	105	Without	AH725

Reference pages: Standard cutting conditions → 5-50 - 5-51

Grade
Insert
Ext. Toolholder
Int. Toolholder
Threading
Grooving
Shaper
Endmill
Drilling Tool
Technical Reference

Small diameter solid carbide internal threading endmill, short edge type, left hand cutting, for UN profile, for hardened steel



Designation	TPI	Application range	DCONMS	DC	NOF	LH	LF	Coolant hole	Grade
MTECSH06012C480UN	80	≥ #0 (0.060)	6	1.15	3	4	58	Without	AH725
MTECSH06016C656UN	56	≥ #2 (0.086)	6	1.65	3	6.6	58	Without	AH725
MTECSH06019C548UN	48	≥ #3 (0.099)	6	1.9	3	5.2	58	Without	AH725
MTECSH06021C640UN	40	≥ #4 (0.112)	6	2.1	3	6.3	58	Without	AH725
MTECSH06021C840UN	40	≥ #4 (0.112)	6	2.1	3	8	58	Without	AH725
MTECSH06024C740UN	40	≥ #5 (0.125)	6	2.45	3	7	58	Without	AH725
MTECSH06024C940UN	40	≥ #5 (0.125)	6	2.45	3	9.6	58	Without	AH725
MTECSH06025C1032UN	32	≥ #6 (0.138)	6	2.55	3	10.5	58	Without	AH725
MTECSH06032C932UN	32	≥ #8 (0.164)	6	3.2	3	9.5	58	Without	AH725
MTECSH06037C1032UN	32	≥ #10 (0.190)	6	3.7	3	10.5	58	Without	AH725
MTECSH06037C1532UN	32	≥ #10 (0.190)	6	3.7	3	15	58	Without	AH725
MTECSH06042C1128UN	28	≥ #12 (0.216)	6	4.2	3	11	58	Without	AH725
MTECSH0605C1428UN	28	≥ 1/4	6	5	3	14.5	58	Without	AH725
MTECSH06035C1024UN	24	≥ #10 (0.190)	6	3.5	3	10.6	58	Without	AH725
MTECSH08066C1724UN	24	≥ 5/16	8	6.6	3	17	64	Without	AH725
MTECSH08066C2424UN	24	≥ 5/16	8	6.6	3	24	64	Without	AH725
MTECSH06047C1920UN	20	≥ 1/4	6	4.75	3	19	58	Without	AH725
MTECSH0808C2520UN	20	≥ 7/16	8	8	3	25	64	Without	AH725
MTECSH0606C1718UN	18	≥ 5/16	6	6	3	17	58	Without	AH725
MTECSH0606C2318UN	18	≥ 5/16	6	6	3	23	58	Without	AH725
MTECSH08067C2216UN	16	≥ 3/8	8	6.7	3	22	64	Without	AH725
MTECSH08077C2514UN	14	≥ 7/16	8	7.7	3	25	64	Without	AH725
MTECSH10092C2713UN	13	≥ 1/2	10	9.2	3	27.5	73	Without	AH725
MTECSH12114C3411UN	11	≥ 5/8	12	11.4	3	34.5	84	Without	AH725

MTECS-W

Solid carbide internal and external threading endmill, short edge type, for G, BSP profile

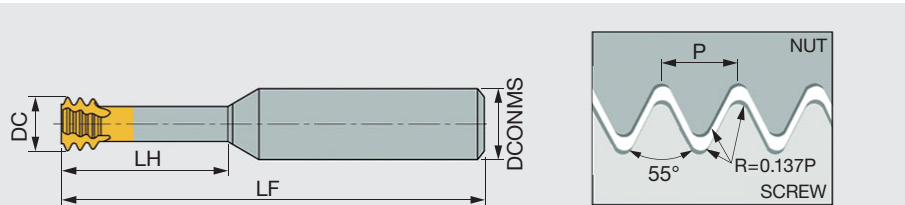

Designation	TPI	Application range	DCONMS	DC	NOF	LH	LF	Coolant hole	Grade
MTECS08078C1928W	28	1/8	8	7.8	3	19.5	64	Without	AH725
MTECS1010D3019W	19	1/4, 3/8	10	10	4	30	73	Without	AH725
MTECS1212D3714W	14	1/2, 5/8, 3/4, 7/8	12	12	4	37	84	Without	AH725

Reference pages: Standard cutting conditions → [5-50](#) - [5-51](#)

MJ

MTECS-MJ

Small diameter solid carbide internal threading endmill, short edge type, with coolant hole, for MJ profile

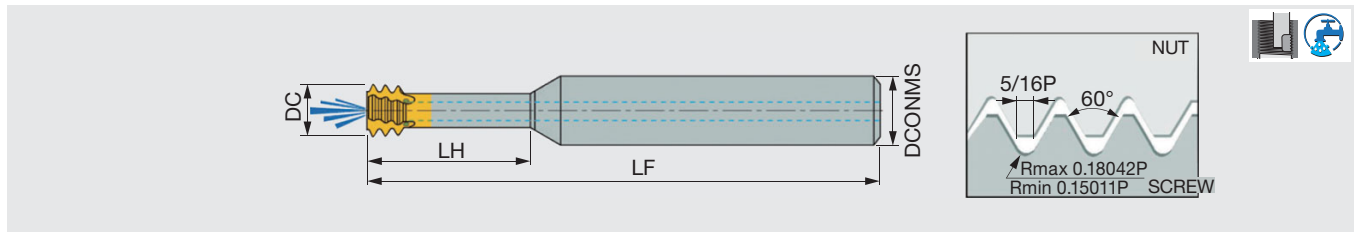

Designation	TP	Application range	DCONMS	DC	NOF	LH	LF	Coolant hole	Grade
MTECS06032C100.7MJ	0.7	≥ 4	6	3.2	3	10	58	Without	AH725
MTECS06039C120.8MJ	0.8	≥ 5	6	3.9	3	12.5	58	Without	AH725
MTECS06048C151.0MJ	1	≥ 6	6	4.8	3	15	58	Without	AH725
MTECS08061C201.25MJ	1.25	≥ 8	8	6.1	3	20	64	With	AH725
MTECS0808C251.5MJ	1.5	≥ 10	8	8	3	25	64	With	AH725
MTECS10092C301.75MJ	1.75	≥ 12	10	9.2	3	30	73	With	AH725
MTECS1010C352.0MJ	2	≥ 14	10	10	3	35	73	With	AH725

UNJ (UNJ, UNJC, UNJF, UNJEF)

MTECS-UNJ

Small diameter solid carbide internal threading endmill, short edge type, with coolant hole, for UNJ profile

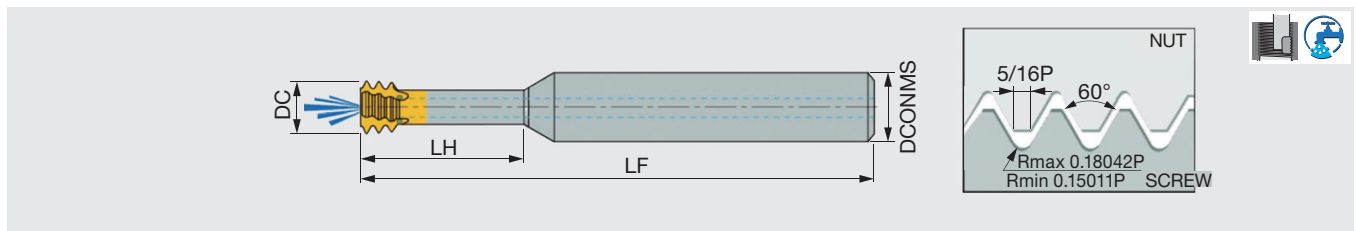

Designation	TPI	Application range	DCONMS	DC	NOF	LH	LF	Coolant hole	Grade
MTECS06033C1032UNJ	32	≥ #8	6	3.3	3	10.5	58	Without	AH725
MTECS08051C1628UNJ	28	≥ 1/4	8	5.1	3	16	64	With	AH725
MTECS08067C2024UNJ	24	≥ 5/16	8	6.7	3	20	64	With	AH725
MTECS06049C1620UNJ	20	≥ 1/4	6	4.9	3	16	58	Without	AH725
MTECS0808C2820UNJ	20	≥ 7/16	8	8	3	28	64	With	AH725
MTECS08061C2018UNJ	18	≥ 5/16	8	6.15	3	20	64	With	AH725
MTECS08069C2416UNJ	16	≥ 3/8	8	6.9	3	24	64	With	AH725
MTECS10094C2713UNJ	13	≥ 1/2	10	9.4	3	27.5	73	With	AH725

Reference pages: Standard cutting conditions → 5-50 - 5-51

Grade
Insert
Ext. Toolholder
Int. Toolholder
Threading
Grooving
Shaper
Endmill
Drilling Tool
Technical Reference

STANDARD CUTTING CONDITIONS

ISO	Material	Condition	Tensile strength [N/mm ²]	Hardness HB	Cutting speed Vc (m/min)	
					AH725	
P	Non-alloy steel and cast steel, free cutting steel	< 0.25 %C	Annealed	420	125	100-250
		≥ 0.25 %C	Annealed	650	190	80-210
		< 0.55 %C	Quenched and tempered	850	250	65-170
		≥ 0.55 %C	Annealed	750	220	110-180
	Low alloy steel and cast steel (less than 5% of alloying elements)		Quenched and tempered	1000	300	95-160
			Annealed	600	200	90-160
				930	275	65-200
			Quenched and tempered	1000	300	70-210
				1200	350	95-160
High alloyed steel, cast steel, and tool steel		Annealed	680	200	130-170	
		Quenched and tempered	1100	325	75-100	
Stainless steel and cast steel		Ferritic/martensitic	680	200	110-170	
		Martensitic	820	240	70-155	
M	Stainless steel	Austenitic	600	180	85-100	
K	Cast iron nodular (GGG)		Ferritic/martensitic	180	120-160	
			Pearlitic	260	75-160	
	Grey cast iron (GG)		Ferritic	160	70-150	
			Pearlitic	250	110-140	
	Malleable cast iron		Ferritic	130	120-160	
		Pearlitic	230	110-140		
N	Aluminum- wrought alloy		Not cureable	60	160-300	
			Cured	100		
	Aluminum-cast, alloyed	≤12% Si	Not cureable	75	150-350	
			Cured	90		
		>12% Si	High temperature	130	100-250	
	Copper alloys		>1% Pb	Free cutting	110	
				Brass	90	
Non-metallic			Electrolitic copper	100		
			Duroplastics, fiber plastics		100-400	
S	High temp. alloys	Fe based		Annealed	200	
				Cured	280	
		Ni or Co based		Annealed	250	20-80
				Cured	350	
	Titanium Ti alloys			Cast	320	
					RM 400	
H	Hardened steel		Alpha+beta alloys cured	RM 1050	20-80	
	Chilled cast iron		Hardened	55 HRC	55-65	
			Hardened	60 HRC	45-55	
Cast iron		Cast	400	90-105		
		Hardened	55 HRC	55-65		

Tool dia.: DC (mm)

Feed: <i>f</i> (mm/t)						
ø2	ø3	ø4	ø6	ø8	ø10	ø12
0.03	0.04	0.04	0.06	0.07	0.08	0.09
0.03	0.04	0.04	0.06	0.07	0.08	0.09
0.02	0.03	0.03	0.05	0.06	0.07	0.08
0.02	0.03	0.03	0.05	0.06	0.07	0.08
0.02	0.02	0.03	0.03	0.04	0.05	0.05
0.02	0.02	0.03	0.03	0.04	0.05	0.05
0.02	0.02	0.03	0.03	0.04	0.05	0.05
0.02	0.02	0.03	0.03	0.04	0.05	0.05
0.02	0.02	0.03	0.03	0.04	0.05	0.05
0.02	0.02	0.03	0.03	0.04	0.05	0.05
0.02	0.02	0.03	0.03	0.04	0.05	0.05
0.02	0.02	0.03	0.03	0.04	0.05	0.05
0.03	0.04	0.04	0.06	0.07	0.08	0.09
0.03	0.04	0.04	0.06	0.07	0.08	0.09
0.03	0.04	0.04	0.06	0.07	0.08	0.09
0.03	0.04	0.04	0.06	0.07	0.08	0.09
0.03	0.04	0.04	0.06	0.07	0.08	0.09
0.03	0.04	0.04	0.06	0.07	0.08	0.09
0.03	0.04	0.04	0.06	0.07	0.08	0.09
0.03	0.04	0.04	0.06	0.07	0.08	0.09
0.02	0.02	0.03	0.03	0.04	0.05	0.05
0.05	0.06	0.07	0.09	0.1	0.11	0.12
0.02	0.02	0.02	0.03	0.03	0.03	0.03
0.02	0.02	0.02	0.03	0.03	0.03	0.03
0.02	0.02	0.02	0.03	0.03	0.03	0.03

When using long edge type tools, Feed could be reduced to 40% of above table.

MTECS

Small Diameter, Short edge type

Thread Milling - Procedure

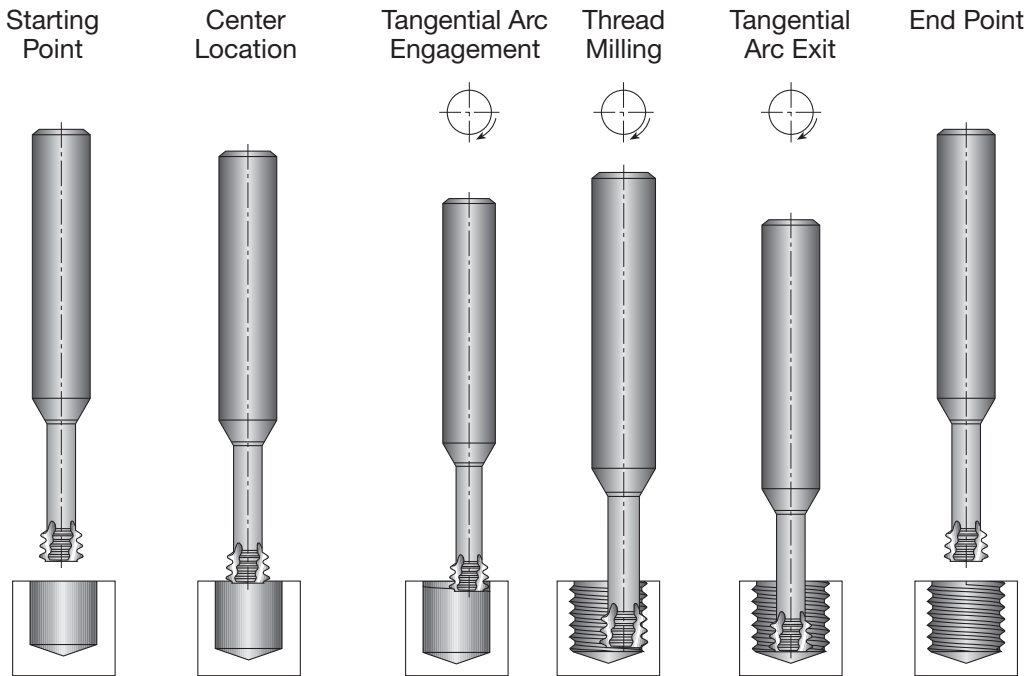

STANDARD CUTTING CONDITIONS

ISO	Material	Cutting speed V_c (m/min)	Feed: f (mm/t)										
			$\phi 1.5$	$\phi 2$	$\phi 3$	$\phi 4$	$\phi 5$	$\phi 6$	$\phi 7$	$\phi 8$	$\phi 9$	$\phi 10$	$\phi 12$
P	Low & medium carbon steels	60-120	0.05	0.05	0.07	0.09	0.11	0.13	0.14	0.15	0.16	0.16	0.17
	High carbon steels	60-90	0.04	0.05	0.06	0.08	0.09	0.1	0.12	0.13	0.14	0.14	0.16
	Alloy steels, treated steels	50-80	0.04	0.04	0.05	0.05	0.06	0.07	0.07	0.08	0.09	0.1	0.12
	Cast steels	70-90	0.04	0.04	0.05	0.05	0.06	0.07	0.07	0.08	0.09	0.1	0.12
M	Stainless steels	60-90	0.03	0.03	0.04	0.05	0.06	0.06	0.07	0.08	0.09	0.1	0.11
K	Cast iron	40-80	0.05	0.05	0.07	0.09	0.11	0.13	0.14	0.15	0.16	0.16	0.17
N	Aluminum	80-150	0.05	0.05	0.07	0.09	0.11	0.13	0.14	0.15	0.16	0.16	0.17
	Synthetics, duroplastics, thermoplastics	50-200	0.1	0.11	0.12	0.14	0.16	0.18	0.19	0.19	0.19	0.19	0.19
S	Nickel alloys, titanium alloys	20-40	0.03	0.03	0.04	0.04	0.05	0.06	0.06	0.06	0.07	0.07	0.07

MTECS Small Diameter, Short edge type

SolidThread MTECS is used for the production of small internal threads. These thread mills feature a short 3-tooth cutting zone with 3 flutes and a released neck between the cutting zone and the shank. This unique tool design offers very precise profiles and a high performance AH725 submicron carbide grade with PVD titanium aluminum nitride coating. The very short profile exerts a low force which minimizes tool bending. This facilitates parallel and high thread precision for the entire length.

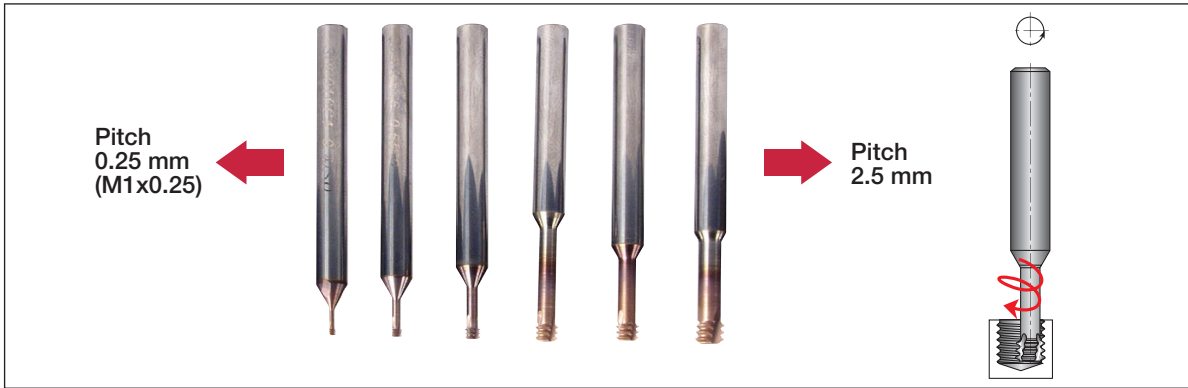

Compared to taps, the **SOLIDTHREAD** is more accurate, thread machining is substantially faster and there is no danger of a broken tap being stuck in the hole.

SolidThread vs. Tap

Criteria	Thread mill	Taps
Thread surface quality	High	Medium
Thread geometry	Very accurate	Medium
Thread tolerance	4H, 5H, 6H with std. cutter	6H with standard tap, 4H with special tap
Machining time	Shorter or same as tap	Short
Machining load	Very low	High
Range of thread diameters	Wide range of diameters (able to thread a wide range of hole sizes)	Specific tap for each thread size
Right-/Left-hand threading	Same cutter	Specific tap for right- and left-hand

Features

- Minimum thread size of MTECS: **M1x0.25** (0.75 mm pre hole diameter) up to M20x2.50
- 2xD and 3xD threading lengths
- High cutting speeds
- Short cycle time
- Low cutting forces due to the short contact profile resulting in accurate and parallel thread
- Prevents oval threads near thin walls
- No more dealing with broken taps
- Reliable threading in blind holes
- Excellent performance on hardened steel, high temperature alloys and titanium



Thread Tool Selector

- Tungaloy's advanced selector empowers you to identify the ideal thread tool by inputting both the thread specifications and details about the work material.
- Navigate through the dropdown options to access comprehensive tool information and recommended machining conditions tailored to the specific thread specifications you've chosen.
- It's important to note that this selector is tailored specifically for right-hand thread machining.

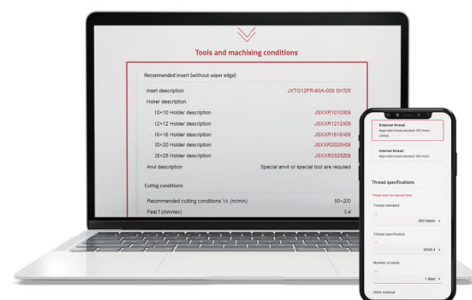

Grade

Insert

Ext. Toolholder

Int. Toolholder

Threading

Grooving

Shaper

Endmill

Drilling Tool

Technical Reference

ISO metric (M)

VMT***IS

3 - 6 flute, full profile, for internal thread



Threading

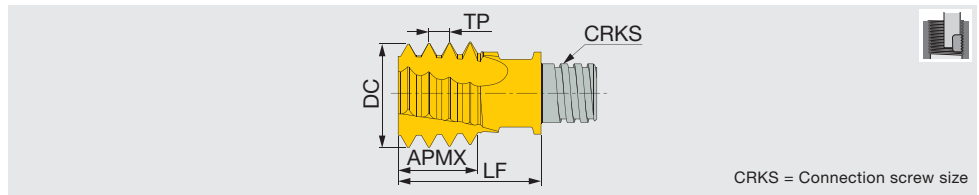

CRKS = Connection screw size

Designation	AH725	TP	Application range	DC	NOF	APMX	LF	CRKS	Wrench	Torque*
VMT100L06IS07-4S05	●	0.75	≥ M12	10	4	6	12.8	S05	KEYV-S05	7
VMT100L06IS10-4S05	●	1	≥ M12	10	4	6	12.8	S05	KEYV-S05	7
VMT100L06IS15-4S05	●	1.5	≥ M13	10	4	6	12.8	S05	KEYV-S05	7
VMT120L08IS15-4S06	●	1.5	≥ M16	12	4	7.6	14.3	S06	KEYV-S06	10
VMT120L08IS20-4S06	●	2	≥ M16	12	4	8	14.3	S06	KEYV-S06	10
VMT160L12IS15-6S08	●	1.5	≥ M20	16	6	12	19	S08	KEYV-T30L	15
VMT160L12IS20-5S08	●	2	≥ M19	16	5	12	19	S08	KEYV-T30L	15
VMT154L13IS25-5S08	●	2.5	≥ M20	15.4	5	12.7	20	S08	KEYV-S08	15
VMT160L12IS30-3S08	●	3	≥ M20	16	3	12	19	S08	KEYV-T30L	15

Torque*: Recommended clamping torque (N-m)
2 pieces per package

● : Line up

Unified (UN, UNC, UNF, UNEF, UNS)

VMT***UN

3, 4, 5 flute, full profile, for internal thread



Threading

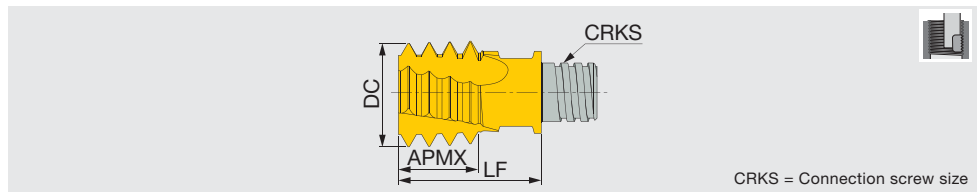

CRKS = Connection screw size

Designation	AH725	TPI	Application range	DC	NOF	APMX	LF	CRKS	Wrench	Torque*
VMT100L06UN24-4S05	●	24	≥ 1/2	10	4	5.3	12.8	S05	KEYV-S05	7
VMT100L06UN20-4S05	●	20	≥ 1/2	10	4	5.1	12.8	S05	KEYV-S05	7
VMT120L08UN16-4S06	●	16	≥ 5/8	12	4	8	14.3	S06	KEYV-S06	10
VMT120L10UN14-4S06	●	14	≥ 5/8	12	4	9	14.3	S06	KEYV-T25	10
VMT160L13UN12-5S08	●	12	≥ 13/16	16	5	12.7	19	S08	KEYV-T30L	15
VMT150L13UN10-4S08	●	10	≥ 3/4	15.4	4	12.7	19	S08	KEYV-T30L	15
VMT160L11UN09-3S08	●	9	≥ 7/8	16	3	11.3	19	S08	KEYV-T30L	15
VMT160L13UN08-3S08	●	8	≥ 15/16	16	3	12.7	20	S08	KEYV-S08	15

Torque*: Recommended clamping torque (N-m)
2 pieces per package

● : Line up

Reference pages: Standard cutting conditions → [8-54](#)

Whitworth (G, Rp, BSP, PF, PS)

VMT***W

4 flute, full profile, for internal/external thread

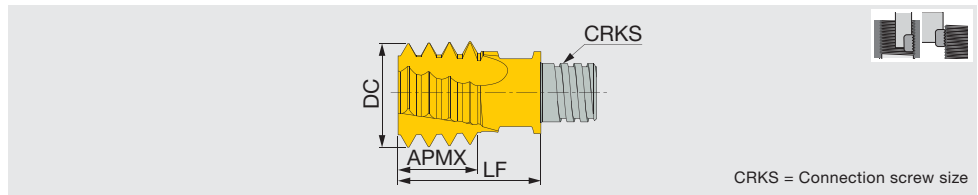

CRKS = Connection screw size

Designation	AH725	TPI	Application range	DC	NOF	APMX	LF	CRKS	Wrench	Torque*
VMT100L06W19-4S05	●	19	1/4, 3/8	10	4	5.3	12.8	S05	KEYV-S05	7
VMT160L13W14-4S08	●	14	1/2, 5/8, 3/4, 7/8	16	4	12.7	20	S08	KEYV-S08	15
VMT160L11W11-4S08	●	11	≥1	16	4	11.6	19	S08	KEYV-T30L	15

Torque*: Recommended clamping torque (N-m)
2 pieces per package

● : Line up

60° partial profile

VTR***IS

3, 4 flute, partial profile, for internal/external thread

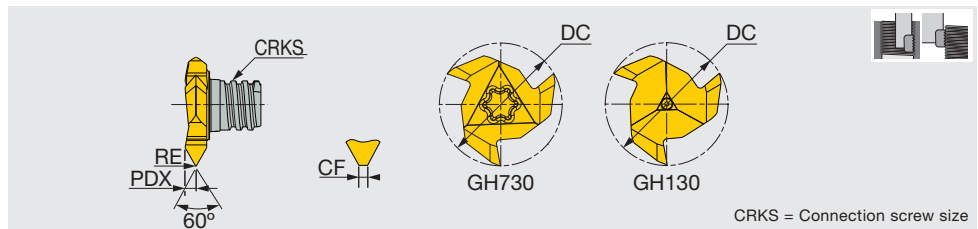

CRKS = Connection screw size

Designation	GH730	GH130	TP		Smallest Possible thread	DC	NOF	RE	CF	PDX	CRKS	Wrench	Torque*
			TPN	TPX									
VTR160L12IS05-3S06	●	▲	0.5	2	M20	15.7	3	-	0.05	1.4	S06	KEYV-177(1) / KEYV-T25(2)	10
VTR160L12IS15-3S06	●	▲	1.5	2	M22	15.7	3	0.05	-	1.4	S06	KEYV-177(1) / KEYV-T25 ⁽²⁾	10
VTR220L28IS30-4S08	●	▲	3	4.5	M36	21.7	4	0.2	-	2.8	S08	KEYV-217(1) / KEYV-T30L(2)	15

(1) Applicable for GH130

(2) Applicable for GH730

Torque*: Recommended clamping torque (N-m)
2 pieces per package

● : Line up

▲ : To be discontinued

55° partial profile

VTR***W

4 flute, partial profile, for internal/external thread

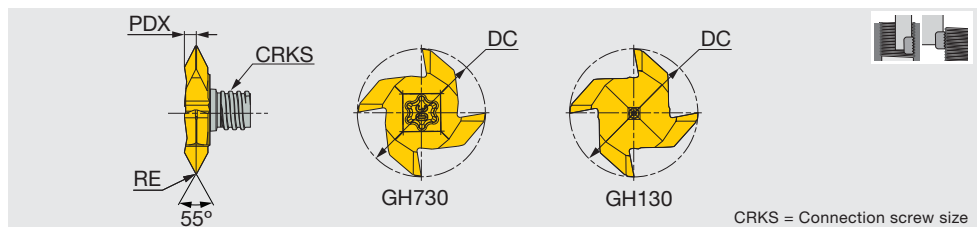
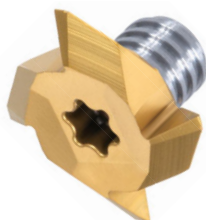

CRKS = Connection screw size

Designation	GH730	GH130	TPI		Smallest Possible thread	DC	NOF	RE	PDX	CRKS	Wrench	Torque*
			TPIN	TPIX								
VTR220L24W14-4S08	●	▲	14	11	3/4	21.7	4	0.2	2.4	S08	KEYV-217(1) / KEYV-T30L(2)	15

(1) Applicable for GH130

(2) Applicable for GH730

Torque*: Recommended clamping torque (N-m)
2 pieces per package

● : Line up

▲ : To be discontinued

Reference pages: Standard cutting conditions → 8-54

Grade

Insert

Ext. Toolholder

Int. Toolholder

Threading

Grooving

Shaper

Endmill

Drilling Tool

Technical Reference

STANDARD CUTTING CONDITIONS

Threading

VMT, VTR

ISO	Material	Condition	Tensile strength [N/mm ²]	Hardness	Cutting speed V _c (m/min)	Tool dia. : DC (mm)				
						Feed per tooth: fz (mm/t)				
						ø10	ø12	ø15.4, ø15.7, ø16	ø21.7	
P	Non-alloy steel and cast steel, free cutting steel	< 0.25 %C	Annealed	420	125 HB	100 - 250	0.08	0.09	0.12	0.15
		≥ 0.25 %C	Annealed	650	190 HB	80 - 210	0.08	0.09	0.12	0.15
		< 0.55 %C	Quenched and tempered	850	250 HB	65 - 170				
		≥ 0.55 %C	Annealed	750	220 HB	110 - 180	0.07	0.08	0.1	0.12
		Quenched and tempered	1000	300 HB	95 - 160	0.07	0.08	0.1	0.12	
	Low alloy steel and cast steel (less than 5% of alloying elements)	Annealed	600	200 HB	90 - 160	0.05	0.05	0.07	0.08	
		Quenched and tempered	930	275 HB	65 - 200	0.05	0.05	0.07	0.08	
			1000	300 HB	70 - 210	0.05	0.05	0.07	0.08	
			1200	350 HB	95 - 160	0.05	0.05	0.07	0.08	
		High alloyed steel, cast steel, and tool steel	Annealed	680	200 HB	130 - 170	0.05	0.05	0.07	0.08
Quenched and tempered	1100		325 HB	75 - 100	0.05	0.05	0.07	0.08		
Stainless steel and cast steel	Ferritic/martensitic	680	200 HB	110 - 170	0.05	0.05	0.07	0.08		
	Martensitic	820	240 HB	70 - 155	0.05	0.05	0.07	0.08		
M	Stainless steel	Annealed	600	180 HB	85 - 100	0.05	0.05	0.07	0.08	
K	Cast iron nodular (GGG)	Ferritic/martensitic		180 HB	120 - 160	0.08	0.09	0.12	0.15	
		Pearlitic		260 HB	75 - 160	0.08	0.09	0.12	0.15	
	Grey cast iron (GG)	Ferritic		160 HB	70 - 150	0.08	0.09	0.12	0.15	
		Pearlitic		250 HB	110 - 140	0.08	0.09	0.12	0.15	
	Malleable cast iron	Ferritic		130 HB	120 - 160	0.08	0.09	0.12	0.15	
		Pearlitic		230 HB	110 - 140	0.08	0.09	0.21	0.15	
N	Aluminium-wrought alloy	Not cureable		60 HB	160 - 300	0.08	0.09	0.12	0.15	
		Cured		100 HB						
	Aluminium-cast, alloyed	≤12% Si	Not cureable		75 HB	150 - 350	0.08	0.09	0.12	0.15
			Cured		90 HB					
		>12% Si	High temperature		130 HB	100 - 250	0.05	0.05	0.07	0.08
	Copper alloys	>1% Pb	Free cutting		110 HB					
			Brass		90 HB					
			Electrolytic copper		100 HB					
	Non-metallic	Duroplastics, fiber plastics				100 - 400	0.11	0.12	0.15	0.18
		Hard rubber								
S	High temp. alloys	Fe based	Annealed		200 HB					
			Cured		280 HB					
		Ni or Co based	Annealed		250 HB	20 - 80	0.03	0.03	0.04	0.04
			Cured		350 HB					
			Cast		320 HB					
	Titanium Ti alloys		RM 400							
	Alpha+beta alloys cured	RM 1050		20 - 80	0.03	0.03	0.04	0.04		
H	Hardened steel	Hardened		55 HRC	55 - 65					
		Hardened		60 HRC	45 - 55					
	Chilled cast iron	Cast		400 HB	90 - 105					
	Cast iron	Hardened		55 HRC	55 - 65					

Thread Whirling





For high-efficiency thread cutting

High productivity for precision screw manufacturing, like implant screws and bone screws

Ideal for medical screw thread forms that are becoming more complex
Single pass thread forming reduces cycle time

Features

NTK's insert design technology creates precise inserts matching even the most complex thread forms
Sharp cutting edges and PVD coated inserts generate superior surface finishes and achieves long tool life

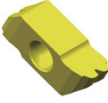
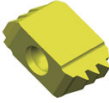
	Double-lead threads	Triple-lead threads
Work	Bone screw	Worm screw
Work material	Ti-6Al-4V ELI	brass
Workpiece		
Insert shape		
Major Dia.	φ4.0	φ7.0
Minor Dia.	φ2.4	φ4.7
Lead [Pitch×No. of Lead]	3.42mm	4.9mm

Machining multi-lead thread forms has many process requirements.
So it is important to contact us to discuss: mechanical specifications, spindle specifications, insert specifications, tooling specifications.

Thread whirling process vs. single point threading

In thread whirling, the whirling head is tilted to a specific helix angle, the cutter is rotated at high speed, the bar stock (c axis) is rotated at a low speed, and the pitch (z axis) is the feed.

The inserts shear the material which enables single pass thread forming.

Single point threading

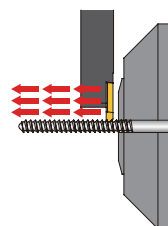

Thread whirling

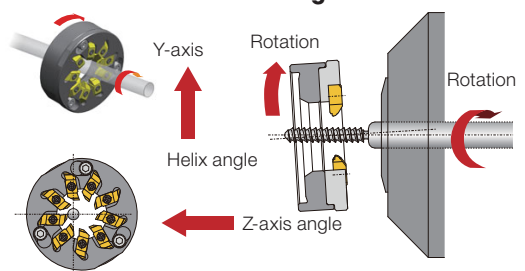

Special Item Capability

- Even though almost all bone screw shapes are special, NTK thread whirling inserts can make the correct shape of thread the first time, without any redesign or remanufacturing
- The combination of a sharp cutting edge and PVD coating achieves an excellent finish and long tool life.

Instructions

1. Refer to our chart and find your machine and spindle model. Select the suitable whirling cutter.
2. Submit the machine , spindle model information, workpiece drawing, material, and bar stock diameter to NTK. NTK calculates the lead angle and insert geometry from the work drawing and manufactures a dedicated insert.
3. Set the whirling cutter at the specified lead angle and set the cutting conditions.

Recommended Cutting Conditions

Conditions / No. of teeth		9	6	4	
Main spindle	min-1	10-40	10-25	7-15	Faster RPM reduces machining time
Whirling cutter	min-1	1500-4000			
Feed Rate		Same as thread lead = pitch			
Bar stock	mm	-φ10	-φ10	-φ8	
Work Material		Ti-6Al-4V EL / SUS316 / 17-4PH / Titanium / brass			

Formula for calculating thread whirling process time

$$T \text{ (Seconds)} = \frac{60 \times \text{Thread length}}{\text{Main spindle rpm} \times \text{Feed rate (Thread lead)}}$$

Ex.) Double lead / 50mm length / 2mm lead (2 × 1mm pitch) / 30 rpm

$$T \text{ (Seconds)} = \frac{60 \times 50\text{mm}}{30\text{rpm} \times 2\text{mm}} = 40 \text{ Seconds}$$

Applicable Thread Geometry (Approximated)

Lead of thread design

Bar stock diameter
~ φ 10 mm
(for cutters with 12mm ID)

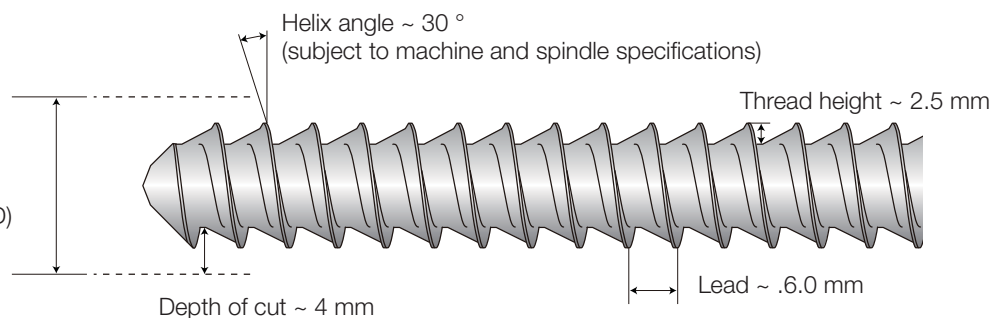

The geometries shown above are approximated and could vary by actual applications

Double-lead Bone Screw Process Example

1. 1st thread whirl at taper area
2. Rotate the bar 180° and whirl the 2nd thread on same area as 1
3. Thread whirl the straight section
4. To obtain two exits on the screw, back up half a lead (one pitch) and rotate 180 degrees. Additional machining is performed at the exit.

Basic Insert Grade : ZM3

ZM3 is the common grade for NTK thread whirling

ZM3 offers excellent surface finish

NTK can make inserts with other coatings to meet customers demands

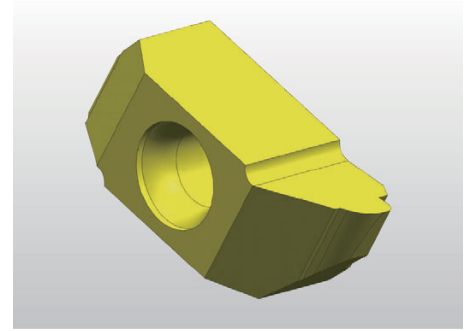

NTK Thread Machining Examples

For absolute flat on OD

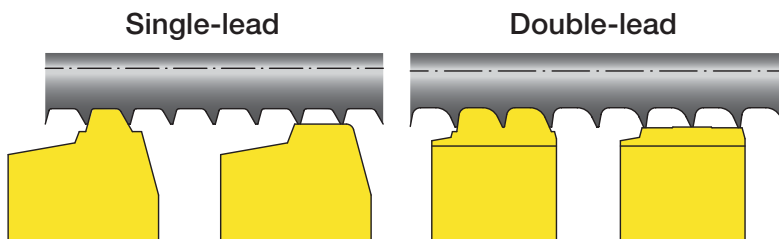

Two insert combination brings absolute flat on OD to meet drawing specifications.

For tiny thread

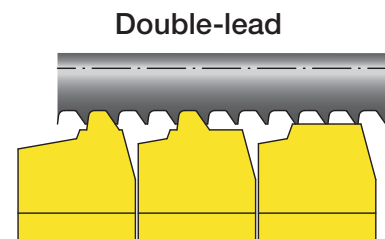

NTK's Thread Whirling system can machine small diameter multi-lead screws to spec, with lower tool pressure, by using several types of specially designed and accurately ground inserts on the cutter.

NTK's Unique Attachment System

NTK's whirling insert holder can be attached and detached without removing mounting screws



① Loosen the Mounting Screws

② Rotate the Insert Holder 10 degrees

③ Detach the Insert Holder without removing the Mounting Screws

Application Examples

Double-lead Bone Screw			
Work Material : Ti - 6Al - 4v ELI			
Bar Stock Dia.	Φ9.5	Number of start	2
Major Dia.	Φ4.0	Helix Angle	28.5°
Minor Dia.	Φ2.5	Hand of thread	Right
Cutting condition			
Main Spindle Speed (rpm)	15	Speed of whirling cutter (rpm)	3,500
Lead = Feed (mm/rev)	5.5	Result	OK
NTK Thread Whirling	Dramatically improved productivity		
Competitor's Thread Whirling	Cannot complete with single pass. Requires feeding stock multiple times and two passes for threading each time.		
NTK thread whirling succeeded in double lead screw machining when one of the major thread whirling suppliers has failed many times.			

Single - lead Bone Screw			
Work Material: 316SS			
Bar Stock Dia.	\$8.0	Number of start	1
Major Dia.	Φ3.45	Helix Angle	7.5°
Minor Dia.	Φ2.67	Hand of thread	Right
Cutting condition			
Main Spindle Speed (rpm)	23	Speed of whirling cutter (rpm)	2,000
Lead = Feed (mm/rev)	1.24	Result	OK
NTK Thread Whirling	2,600 pcs		
Competitor's Thread Whirling	1,000 pcs		
Some thread whirling manufacturers offer 6-teeth or 12-teeth systems, too many teeth cause chip packing issues and more tool pressure. Fewer teeth means greater cycle time. NTK concluded that 9-teeth is the best configuration. Our customers can run 1.5 times faster and get longer tool life.			

Triple - lead Worm Gear			
Work Material: Brass			
Bar Stock Dia.	Φ8.0	Number of start	3
Major Dia.	Φ7.0	Helix Angle	14.6°
Minor Dia.	Φ4.7	Hand of thread	Left
Cutting condition			
Main Spindle Speed (rpm)	20	Speed of whirling cutter (rpm)	3,500
Lead = Feed (mm/rev)	4.8	Result	OK
Multi-lead threads, common in the Worm Gear industry are made by a forming or cutting process. The large helix angle is difficult to machine with single-point threading. NTK now makes thread whiling inserts for multi-lead threads. Cycle time is reduced with a one pass process and thread form dimensions are stable with the low tool pressure.			

Grade
Insert
Ext. Toolholder
Int. Toolholder
Threading
Grooving
Shaper
Endmill
Drilling Tool
Technical Reference

1
2
3
4
5
6
7
8
9
10

Thread Whirling System

No.1

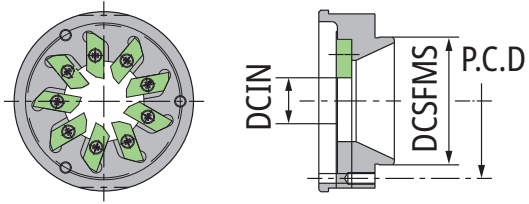

No.2

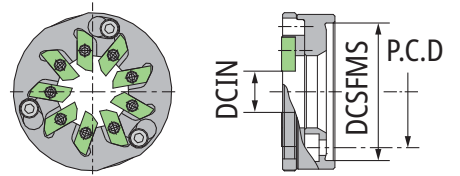

No.3

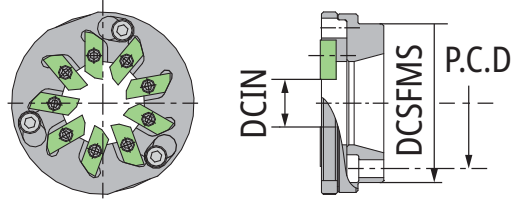

No.4

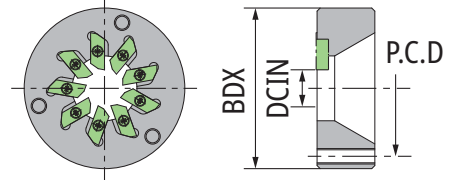

No.5

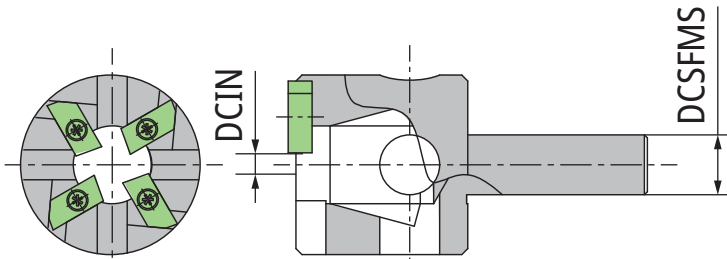

No.6

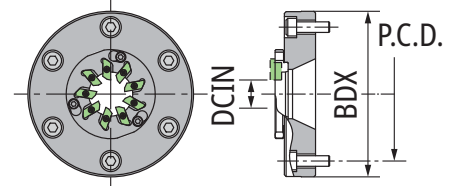

Guideline: Raw material diameter up to 6, machinable up to length 18mm
(Contact CD for further information)

No.7

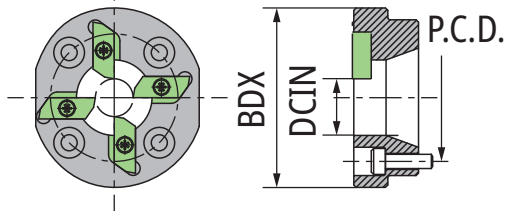

No.8

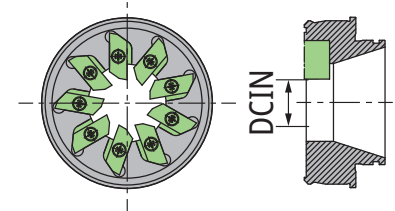

No.9

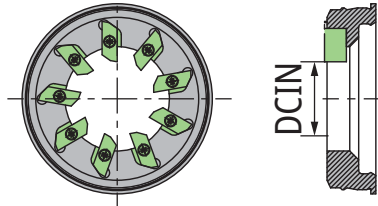

Spare Insert Holder (Cartridge)

Item number	No. of tooth	φDm	Compatible cutters
TWC6HP2	6	12	No.2, No.3※
TWC9HP2	9	12	No.2, No.3※
TWC9HP2-D16	9	12	No.6※

※Cannot be used for TWC9TS20550P2, TWC9TO12050P2-D18 and TWC9HA22594P2

Note(s): Note: Insert holder comes with insert screws and wrench
Insert holder mounting screw is not included

Spare Parts

Description		Item number
Insert Screw	for 4mm thick inserts	FSI17-2.2×6.0
	for 6.5mm thick inserts	FSI24-2.2×7.9
Wrench		T-07
Insert Holder Mounting Bolt		CS0309-TW

Thread Whirling System

Machine make	Model	Location	Spindle make	Spindle model	Helix angle	No.	NTK Whirling cutter	No. of tooth	φDm (mm)	φDs	P.C.D.	Mount adapter bolt							
CITIZEN	M432-VII	Gang	CITIZEN	BTW-4000	0°- 15°	1	TWC9C0746HP1	9	φ12	φ46	φ35	M3							
	L20/L20E/L20X	Gang		BTW-3000	0°- 15°														
	L32/L32X			BTW-3100	0°- 15°														
	D25	Gang		BTW-3100	0°- 15°														
	L32X			BTW-6000	±25°														
	L20X			BTW-5000	±25°														
	M16				0°- 15°														
	A20				BTW-2000		±25°												
	A32			Gang			BTW-1000	±25°											
	L20/L20X							±25°											
	L32/L32X								+20°- -25°										
	M20				±25°														
	M32				M32		M32	M32											
	C32																		
	L20																		
	M20																		
	M32																		
	C12/16	Gang		CITIZEN	LTRO170		±15°	2	TWC9C1037P2	9	φ12	φ37	φ30.5	CS0310 (M3)					
M2/16	Turret	LTRO128/ LTRO168																	
M2/16III		MSW105																	
M20/32III	Gang	KSW110																	
L20		LTRO183	±15°																
M20/32		LTRO183																	
M20/32	Turret	LTRO169																	
K16	Attachment	PCM	GSW-101	±15°	1	TWC6P1620HP1-D9	6	φ9	φ32	φ26	M4 (Provided with spindle)								
L20	Gang		LSW-101-L20	±10°	2	TWC9P1340P2	9	φ12	φ40	φ32	M4 (Provided with spindle)								
M20/16	Turret		NSW-101																
M20/M32	Turret		KSW-101																
STAR	SW-12	Attachment	STAR	10159	±20°	7	TWC4S1433HP1	4	φ8	φ38	φ27	CS0310 (M3)							
	ECAS-12/20			54178	±10°														
	SB-20R			0M171	-20°- 0°														
	SR-20J/20RIII 20RIV/32JII			68172	-20°- 0°														
	ECAS-20T	Turret		59172	±20°								3	TWC9S1640P2	9	φ12	φ40	φ33	CS04148S (M4)
	ECAS-32T			58171															
	SR-38	Attachment		10172	±10°														
	ST-38	Turret		43156	±20°														
	SV-12			45172	±10°														
	SV-20/SV-20R			42173	±10°														
	SV-32			43172	±10°														
	SV-38R			43156	±20°														

Grade
Insert
Ext. Toolholder
Int. Toolholder
Threading
Grooving
Shaper
Endmill
Drilling Tool
Technical Reference

1
2
3
4
5
6
7
8
9
10

Thread Whirling System

Machine make	Model	Location	Spindle make	Spindle model	Helix angle	No.	NTK Whirling cutter	No. of tooth	φDm (mm)	φDs	P.C.D.	Mount adapter bolt		
TSUGAMI	BH20/BH38	Turret	TSUGAMI	3263-Y481	±10°	3	TWC9TS2252P2	9	φ12	φ52	φ42	CS0515 (M5)		
	B038T			3263-Y2481	±10°	3	TWC9TS2252P2	9	φ12	φ52	φ42	CS0515 (M5)		
	BS20			3214-Y1371	±10°	3	TWC9TS20550P2	9	φ16	φ50	φ40	CS0515 (M5)		
	SS20/SS26/SS32 B0265/B0266-II B0325/B0326-II B0265/B0266(V)-III B0325/B0326(V)-III BW269Z/BW329Z	Attachment		3268-Y451	0°-10°	4	TWC9TS2244HP1	9	φ12	φ52	φ44	CS0520 (M5)		
	S205/S206			3281-Y451	0°-20°	4	TWC9TS1944HP1	9	φ12	φ52	φ44	CS0515 (M5)		
	S205/S206-II			3281-Y2451	0°-25°	4	TWC9TS1644HP1	9	φ12	φ52	φ44	CS0515 (M5)		
	B0123/124/126-II B0203/204 /205/205-III/206-II			3220-Y6541	0°-30°	4	TWC9TS1044HP1	9	φ12	φ52	φ44	CS0515 (M5)		
	SS20/SS26/SS32			3268-Y271	0°-15°	4	TWC9TS1952P2BK	9	φ12	φ52	φ38	CS0515 (M5)		
	SS20/SS26/SS32	3268-Y271		0°-20°	4	TWC9TS1652P2BK	9	φ12	φ52	φ38	CS0515 (M5)			
	SS207/SS267/ SS327	B-axis		Using B-axis	0°-15°	5	TWC4TS3010HP1	4	φ7	φ10	For single-corner inserts only			
	SS267/SS327-III			3293-Y3031	0°-15°	4	TWC9TS1944HP1	9	φ12	φ52	φ44	CS0520 (M5)		
	TORNOS	DECO 10/10a		Attachment	TORNOS	224-1900	±15°	4	TWC6TO11542HP1	6	φ12	φ42	φ32	CS0410 (M4)
		Evo DECO 10/10				242-1900								
DECO 13a/13e		226-1900												
Evo DECO 16/10		243-1900	±15°			3	TWC9TO10540P2	9	φ12	φ40	φ31	CS0410 (M4)		
Swiss ST26		246-1900												
DECO 20a		223-1900												
DECO 26a		225-1900	±25°			3	TWC9TO12050P2-D18	9	φ18	φ50	φ40	CS0410 (M4)		
Sigma 20		234-2750												
Sigma 32		236-2750												
HASEGA-WA	JS-1W	-	HASEGA-WA	-	0° -20°	6	TWC9HA22594P2	9	φ16	φ94	φ76	CS0620 (M6)		
Various Machines	-	-	WTO	42BJ	-22°	8	TWC9WT42BJ20D12RH	9	φ12	-	-	-		
	-	-		54BJ	30°	9	TWC9WT54BJ30D12RH	9	φ12	-	-	-		
	-	-		54BJ	30°	9	TWC9WT54BJ25D22RH	9	φ12	-	-	-		

※ Screws for insert-thickness 4.0/6.0mm are supplied with the cutter body. Use screws for the thickness of the insert you are using.

Standard Thread Whirling Inserts (2corners) for Medical ISO Style Threads
TWC.. series/Inserts Carbide

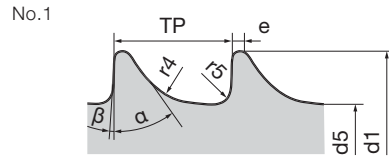

ISO5835 HA

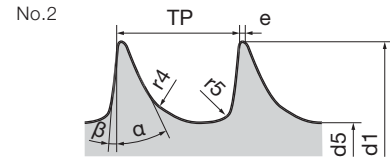

ISO5835 HB

P	Steel	★	
M	Stainless	★	
N	Non-ferrous	★	
S	Superalloys	★	
H	Hard materials		

★ : First choice
☆ : Second choice

Designation	HAND	Coated	ISO	Pitch	d1	d5	e	r4	r5	α	β	Figure
		ZM3										
TW5835-HA1.5-D12	R	●	HA1.5	0.5	1.5	1.1	0.1	0.3	0.1	35	3°	1
TW5835-HA2.0-D12	R	●	HA2.0	0.6	2	1.3	0.1	0.4	0.1	35	3°	1
TW5835-HA2.7-D12	R	●	HA2.7	1	2.7	1.9	0.1	0.6	0.2	35	3°	1
TW5835-HA3.5-D12	R	●	HA3.5	1.25	3.5	2.4	0.1	0.8	0.2	35	3°	1
TW5835-HA4.0-D12	R	●	HA4.0	1.5	4	2.9	0.1	0.8	0.2	35	3°	1
TW5835-HA4.5-D12	R	●	HA4.5	1.75	4.5	3	0.1	1	0.3	35	3°	1
TW5835-HA5.0-D12	R	●	HA5.0	1.75	5	3.5	0.1	1	0.3	35	3°	1
TW5835-HB4.0-D12	R	●	HB4.0	1.75	4	1.9	0.1	0.8	0.3	25	5°	2
TW5835-HB6.5-D12	R	●	HB6.5	2.75	6.5	3	0.2	1.2	0.8	25	5°	2

Must use Thread whirling cutters with 12mm φDm dimension

● : Line up

6. Parting, Grooving



Main products

	<p>DUOJUST</p> <p>Innovative clamping system for high rigidity in parting  CW = 1 - 2 mm</p>	6-99
	<p>TUNGCUT / TUNGSCUT</p> <p>Multi-functional tool series for various grooving operations  CW = 1.4 - 6 mm</p>	6-69, 6-104
	<p>TETRAMCUT</p> <p>Unique insert pocket geometry for grooving with high quality and precision  CW = 0.33 - 3 mm</p>	6-36
	<p>TETRAFORCE</p> <p>4-cornered insert with good clamping rigidity for highly precise grooving and parting  CW = 0.5 - 3.18 mm</p>	6-37
	<p>SNG</p> <p>Internal grooving  CW = 1 - 3.5 mm</p>	6-62
	<p>CSV Series</p> <p>Best for machining with ultra small diameter of $\phi 5$ or less CW = 0.2 - 1.5 mm</p>	6-18
	<p>GTMH32/43 Series</p> <p>Wide range lineup not only width but also chipbreaker and grade  CW = 0.3 - 5.5 mm</p>	6-23
	<p>SATURN Duo</p> <p>Unique tool for face grooving with swiss machine CW = 1.0 - 2.0 mm</p>	6-73
	<p>CTP/CTPA/CTPW Series</p> <p>High precision sharp edge and wide range for parting  CW = 0.5 - 3.0 mm</p>	6-81
	<p>Cut Duo</p> <p>Achieve stable chip evacuation with ground finished chipbreaker  CW = 2.0 - 3.0 mm</p>	6-115 -







Miniature Parting - Quick Guide

Parting

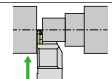

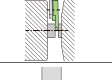
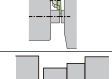
DuoForceCut

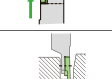
Application	Designation	Insert	Square shank (height x width)				Groove width (mm)	Max. parting diameter (mm)					Page	
			6 x 6	7 x 7	8 x 8	10 x 10		0	10	20	30	40		50
	JSXXR/L*05	JVPN...	●	●	●	●	0.5 - 1	ø4	●	ø12				6-77

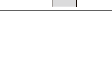
CTP

Application	Designation	Insert	Square shank (height x width)										Groove width (mm)		
			8 x 8	8 x 10	10 x 10	10 x 12	10 x 16	12 x 12	12 x 16	13 x 13	16 x 16	20 x 20			
	CTPR/L-OH2	CTP								●					0.5 - 2.0
	CTPR/L-OH	CTP				●				●			●		0.5 - 2.0
	CTPR/L	CTP		●	●					●			●		0.5 - 2.0
	CTPR/L-SUB-OH3	CTP								●					0.5 - 2.0
	CTPR/L-SUB	CTP	●		●					●					0.5 - 2.0
	CTPAR/L-OH2	CTPA								●			●		0.7 - 3.0
	CTPAR/L	CTPA			●					●			●	●	0.7 - 3.0
	CTPAR/L-SUB	CTPA			●					●			●		0.7 - 3.0
	CTPWR/L	CTPW				●	●	●	●				●	●	2.5

DuoJustCut

Application	Designation	Insert	Square shank (height x width)					Groove width (mm)	Holder
			10 x 10	10 x 12	12 x 12	16 x 16	20 x 20		Through-coolant
	JSXXR/L*09-CHP	JXP...		●	●	●		0.6 - 2	●
	JSXXR/L*09-S-CHP	JXP...	●		●	●		0.6 - 2	●

CSV

Application	Designation	Insert	Square shank (height x width)					Groove width (mm)	Max. parting diameter (mm)					Page		
			7 x 7	8 x 8	9.5 x 9.5	10 x 10	12 x 12		0	10	20	30	40		50	
	CSVR/L	CSVT	●	●	●	●	●	0.6 - 1.5	ø3	ø5						6-79



Holder		Max. parting diameter (mm)						Page
Through-coolant	Direct connection	0	10	20	30	40	50	
●	●	ø5	ø12					6-82
●		ø5	ø12					6-82
		ø5	ø12					6-83
●	●	ø5	ø12					6-81
		ø5	ø12					6-84
●	●	ø6.5	ø16					6-91
		ø6.5	ø16					6-92
		ø6.5	ø16					6-92 6-93
			ø20					6-97

Max. parting diameter (mm)							Page
0	10	20	30	40	50		
ø6		ø20				6-99	
ø6		ø20				6-99	



Miniature Parting - Quick Guide

Parting

 **TungCut**

Application	Designation	Insert	Square shank (height x width)							Groove width (mm)	Holder		
			10 x 10	10 x 12	12 x 12	12 x 16	16 x 16	16 x 20	20 x 12		20 x 20	Modular head	Through-coolant
	QC12-JTTER/L-CHP	DG.../SG...		●	●	●	●	●		1.2 - 2.39	●	●	●
	J*TER/L	DG.../SG...	●		●		●		●	1.2 - 3.18			
	JCTER/L-CHP	DG.../SG...			●		●			2 - 2.39		●	●



CTDP



Application	Designation	Insert	Square shank (height x width)					Groove width (mm)	Holder	
			10 x 10	12 x 12	16 x 16	20 x 12	20 x 20		Through-coolant	Direct connection
	CTDPR/L-OH2/OH3	CTDP		●	●		●	2.0 - 2.5	●	●
	CTDPR/L	CTDP	●	●	●	●	●	2.0 - 2.5		



CTWP

Application	Designation	Insert	Square shank (height x width)		Groove width (mm)	Holder		Max. parting diameter (mm)						Page
			10 x 10	12 x 12		Through-coolant	Direct connection	0	25	50	75	100	125	
	CTWPR/L	GWPFM	●	●	3			ø42						6-118

 **AddForceCut**

Application	Designation	Insert	Square shank (height x width)	Groove width (mm)	Max. parting diameter (mm)						Page
					0	25	50	75	100	125	
	QSER/L	QG...	20 x 20	2 - 4	ø52 ø66						6-119
	QSG	QG...	20 x 20	2 - 4	ø52 ø82						6-119
	QSP	QG...	20 x 20	2 - 5	ø50 ø120						6-119

Max. parting diameter (mm)						Page
0	25	50	75	100	125	
ø12		ø32				6-104
ø12		ø42				6-104 6-105
	ø25		ø32			6-106

Max. parting diameter (mm)						Page
0	25	50	75	100	125	
	ø25.4		ø34			6-115
	ø20		ø34			6-116

Grade

1

Insert

2

Ext. Toolholder

3

Int. Toolholder

4

Threading

5

Grooving

6

Shaper

7

Endmill

8

Drilling Tool

9

Technical Reference

10



Miniature Parting - Quick Guide

External Grooving







CSV

Application	Designation	Insert	Square shank (height x width)					Holder			Groove width (mm)		Max. groove depth (mm)	Page	
			7 x 7	8 x 8	9.5 x 9.5	10 x 10	12 x 12	Modular head	Through-coolant	Direct connection	0	1			2
	CSV/R/L	CSVG	●	●	●	●	●				0.25	1.5	0.15 - 2.6	6-18	

MiniVLockGroove

Application	Designation	Insert	Square shank (height x width)					Holder			Groove width (mm)		Max. groove depth (mm)	Page	
			8 x 8	10 x 10	10 x 12	12 x 12	12 x 16	Modular head	Through-coolant	Direct connection	0	1			2
	QC-SVER/L-CHP Modular head	VGP...			●	●	●	●	●	●	0.33	1	2.5 - 4	6-20	
	SVER/L	VGP...	●	●		●					0.5	1	2 - 4	6-20	

GTM32

Application	Designation	Insert	Square shank (height x width)							Cylindrical shank (shank dia.)							
			8 x 8	8 x 10	10 x 10	10 x 12	12 x 12	12 x 16	16 x 16	20 x 20	ø14	ø15.875	ø16	ø19.05	ø20		
	GTTR-OH2/OH3	GTMH32				●	●		●								
	GTTR/L	GTMH32	●		●		●		●	●							
	CH-GTTL	GTMH32			●		●		●								
	Y-GTTR-OH	GTMH32					●		●								
	Y-GTTR	GTMH32			●		●										
	DS-GTTL	GTMH32									●	●	●	●			

				Holder				Groove width (mm)						Max. groove depth (mm)	Page
ø22	ø25	ø25.4	ø32	Modular head	Y-axis feed	Through-coolant	Direct connection	0	1	2	3	4	5		
						●	●	0.3						0.25 - 2.7	6-23
								0.3						0.25 - 2.7	6-24
								0.3						0.25 - 2.7	6-25
					●	●		0.3						0.25 - 2.7	6-25
					●			0.3						0.25 - 2.7	6-26
●	●	●	●					0.3						0.25 - 2.7	6-26

Grade

1

Insert

2

Ext. Toolholder

3

Int. Toolholder

4

Threading

5

Grooving

6

Shaper

7

Endmill

8

Drilling Tool

9

Technical Reference

10

Miniature Parting - Quick Guide

External Grooving

Application	Designation	Insert	Square shank (height x width)						Cylindrical shank (shank dia.)						
			10 x 10	10 x 12	12 x 12	12 x 16	16 x 16	16 x 20	20 x 20	ø14	ø15.875	ø16	ø19.05	ø20	ø22
	QC-STCR/L-Y-CHP Modular head	TC*18R/L...			●	●	●	●							
	QC-STCR/L-CHP Modular head	TC*18R/L...			●	●	●	●							
	STCR/L-18	TC*18R/L...	●		●		●								
	JS-STCL18	TC*18R...							●	●	●	●	●	●	●
	QR-STCL18-CHP	TC*18R...									●	●	●		

Application	Designation	Insert	Square shank (height x width)				Holder		Groove width (mm)					Max. groove depth (mm)	Page
			10 x 10	12 x 12	16 x 16	20 x 20	Through-coolant	Direct connection	0	1	2	3	4		
	STCR/L-27	TC*27...	●	●	●	●			0.5	3.18				1 - 6.4	6-48
	STCR/L-27-CHP	TC*27...		●		●	●	●	0.5	3.18				1 - 6.4	6-48
	STCR/L-38	TCL38...				●			0.5	4				9 - 10	6-54

Application	Designation	Insert	Square shank (height x width)						Holder				
			10 x 10	10 x 14	12 x 12	12 x 14	12 x 16	16 x 16	20 x 20	Modular head	Y-axis feed	Through-coolant	Direct connection
	GTPAR-OH	GTPA				●						●	
	GTPAR	GTPA	●		●			●					
	Y-GTPAR-OH	GTPA		●			●	●		●	●		

			Holder				Groove width (mm)						Max. groove depth (mm)	Page
	ø25	ø25.4	Modular head	Y-axis feed	Through-coolant	Direct connection	0	1	2	3	4	5		
							0.33							
			●	●	●	●	[Orange bar]						0.8 - 3.5	6-36
			●		●	●	[Orange bar]						0.8 - 3.5	6-36
							[Orange bar]						0.8 - 3.5	6-37
	●	●					[Orange bar]						0.8 - 3.5	6-37
			●		●		[Orange bar]						0.8 - 3.5	6-38

	Groove width (mm)					Max. groove depth (mm)	Page
	1	2	3	4	5		
		2 [Orange bar] 2.5				3.0 - 6.0	6-55
		2 [Orange bar] 2.5				3.0 - 6.0	6-55
		2 [Orange bar] 2.5				3.0 - 6.0	6-56

Grade
Insert
Ext. Toolholder
Int. Toolholder
Threading
Grooving
Shaper
Endmill
Drilling Tool
Technical Reference

1
2
3
4
5
6
7
8
9
10

Miniature Parting - Quick Guide

External Grooving

SCRUM DUO

Application	Designation	Insert	Square shank (height x width)				Holder		Groove width (mm)						Max. groove depth (mm)	Page		
			10 x 10	12 x 12	16 x 16	20 x 20	Through-coolant	Direct connection										
									0	2	4	6	8	10				
	GTWPR/L	GWPG	●	●	●	●			3	4	5	6	7	8	9	10	7.0 - 9.0	6-58

Internal Grooving

SNG

Application	Designation	Insert	Cylindrical shank (shank dia.)					Groove width (mm)	Max. groove depth (mm)	Through coolant
			ø8	ø10	ø12	ø16	ø20			
	A/E-SNGR	*GR/L... *GMR...	●	●	●	●	●	1 - 3.5	1.5 - 3	○

Mogul Bar S-BG

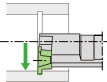
Application	Designation	Insert	Cylindrical shank (shank dia.)						Groove width (mm)	Max. groove depth (mm)	Through coolant
			ø8	ø10	ø12	ø14	ø16	ø20			
	S-BGR	GTG10...		●	●				0.5 - 3	1 - 3	

AddInternalCut

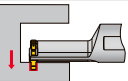
Application	Designation	Insert	Cylindrical shank		Groove width (mm)	Max. groove depth (mm)	Through coolant
			ø12	ø16			
	A/E-STCIR/L	TCIG10/12...	●	●	0.5 - 3	1 - 3	○



TungHeavyGroove

Application	Designation	Insert	Square shank (height x width)			Groove width (mm)						Max. groove depth (mm)	Page
			12 x 12	16 x 16	20 x 20	0	10	20	30	40	50		
	FPGN	PSGB...	●	●	●	0	10	20	30	40	50	-	6-60

Min. bore diameter DMIN (mm)

0	5	10	15	20	25	Page
		ø8			ø24	6-62

Min. bore diameter DMIN (mm)

0	5	10	15	20	25	Page
		ø10			ø20.5	6-66

Min. bore diameter DMIN (mm)

0	5	10	15	20	25	Page
		ø10.5			ø20	6-67

Grade

Insert

Ext. Toolholder

Int. Toolholder

Threading

Grooving

Shaper

Endmill

Drilling Tool

Technical Reference

Miniature Parting - Quick Guide

Internal Grooving

TungShortCut

Application	Designation	Insert	Cylindrical shank			Groove width (mm)	Max. groove depth (mm)	Through coolant
			ø10	ø12	ø16			
	CTIR/L-S	DGS*S/ DTR*S	●	●	●	2 - 3	3 - 6	●

Face Grooving



TetraMini-Cut

Application	Designation	Insert	Square shank (height x width)			Cylindrical shank (shank dia.)							
			10 x 10	12 x 12	16 x 16	ø14	ø15.875	ø16	ø19.05	ø20	ø22	ø25	ø25.4
	JS-STCFL18	TCF18L...				●	●	●	●	●	●	●	●
	STCFVR-18	TCF18L...	●	●	●								

SATURN DUO

Application	Designation	Insert	Square shank (height x width)					Cylindrical shank (shank dia.)								
			10 x 10	10 x 16	12 x 12	12 x 16	16 x 16	ø14	ø15.875	ø16	ø19.05	ø20	ø22	ø25	ø25.4	
	FGVR	FGV FBV		●		●	●									
	CH-FGVR/L	FGV FBV	●		●		●									
	DS-FGVR/L	FGV FBV								●	●	●	●	●	●	

FaceMiniCut

Application	Designation	Insert	Cylindrical shank (shank dia.)				Groove width (mm)	Max. groove depth (mm)	Min. face groove outside diameter (mm)						Page	
			ø12	ø12.7	ø15.875	ø16			0	5	10	15	20	25		
	A-MFR/O	MFR10	●	●	●	●	2 - 2.5	9			ø10					6-76

Min. bore diameter DMIN (mm)

	5	10	15	20	25	Page
		ø12	ø16			6-69

Groove width (mm)	Max. groove depth (mm)	Min. face groove outside diameter (mm)						Page
		0	5	10	15	20	25	
0.5 - 2.5	1 - 3		ø6					6-71
0.5 - 2.5	1 - 3		ø6					6-71

Groove width (mm)	Max. groove depth (mm)	Min. face groove outside diameter (mm)						Page
		0	5	10	15	20	25	
1.0 - 2.0	1.5 - 3		ø6					6-73
1.0 - 2.0	1.5 - 3		ø6					6-73
1.0 - 2.0	1 - 3		ø6					6-74

TUNGCUT

Multi-functional grooving tool series with excellent versatility

New modular holder system enhances versatility of existing monoblock holder and TungCap (PSC) lines. High-pressure coolant system improves chip flow and tool life.



High clamping rigidity *For stable tool life and accuracy*

Clamping system



Stable and safe contact areas

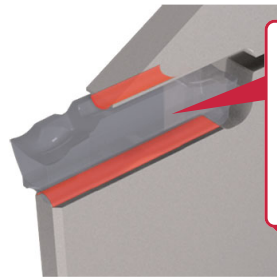

High repeatability and durability due to long pocket!

Minimizes cutting edge displacement

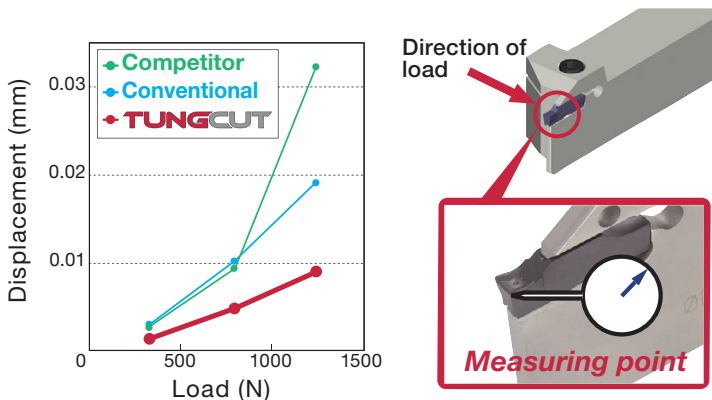

New double-ended small-size internal grooving inserts with exceptional features

Robust toolholder design



CTIR**S

(Toolholder that accommodates downsized internal grooving insert)

1 Improved chatter resistance

- Optimized screw location enhances insert clamping capability
- Shorter slot length

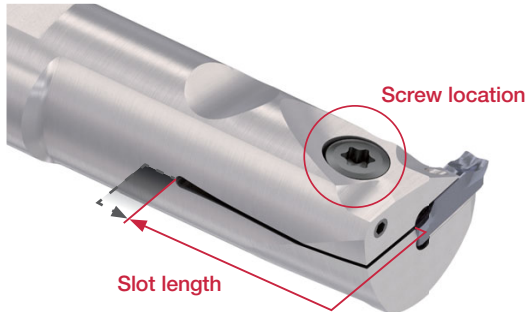

2 Effective chip evacuation

- Larger pockets promote smooth chip evacuation

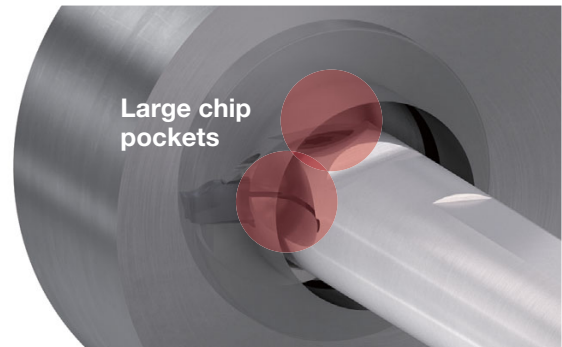

3 Internal coolant system

- Precision coolant delivered from the top to the cutting point for best performance and smooth chip evacuation.

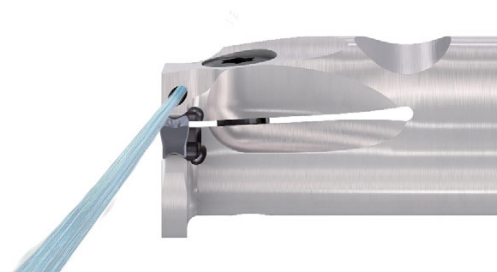

GTMH-GX Chipbreaker

For Grooving | Swiss CNC Lathes

Groove widths from: 0.33 mm - 3.0 mm

Grooving & side turning with excellent chip control

Groove width 1.5mm



Groove width 1.0mm

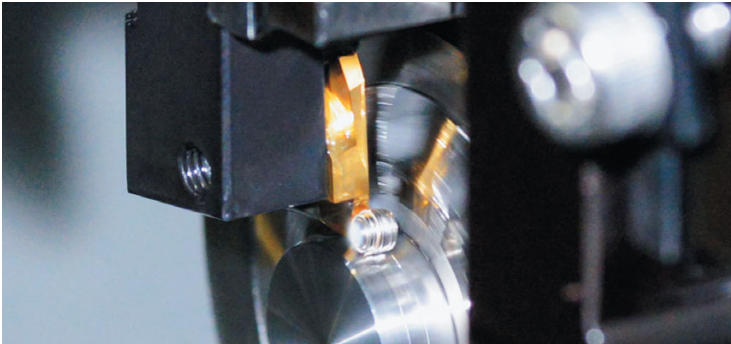

Functioning range

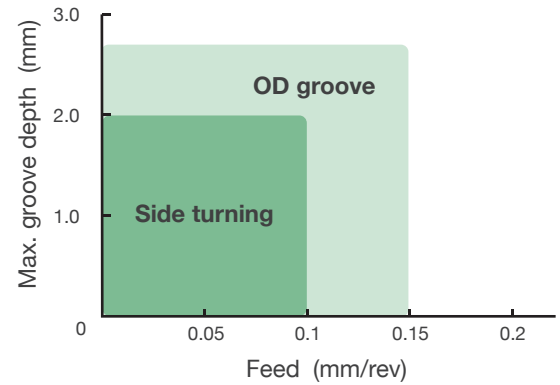

Excellent chip control

	<p>GX Chipbreaker</p>	
<p>Cutting conditions Material: AISI 316L vc=80m/min f=0.02mm/rev ap=2.5mm WET</p>	<p>Competitor</p>	

Reference pages: Inserts → [6-27 - 6-33](#), Toolholders → [6-23 - 6-26](#)

CTP/CTPA-CX Chipbreaker

For Parting off | Swiss CNC Lathes

Curls and controls chips. Achieves good surface finish

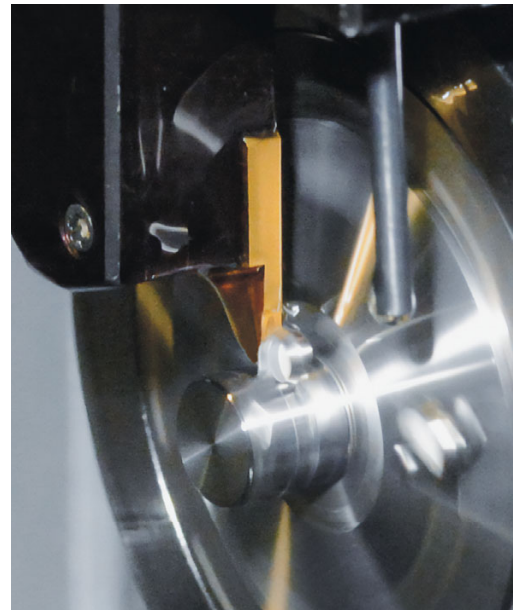
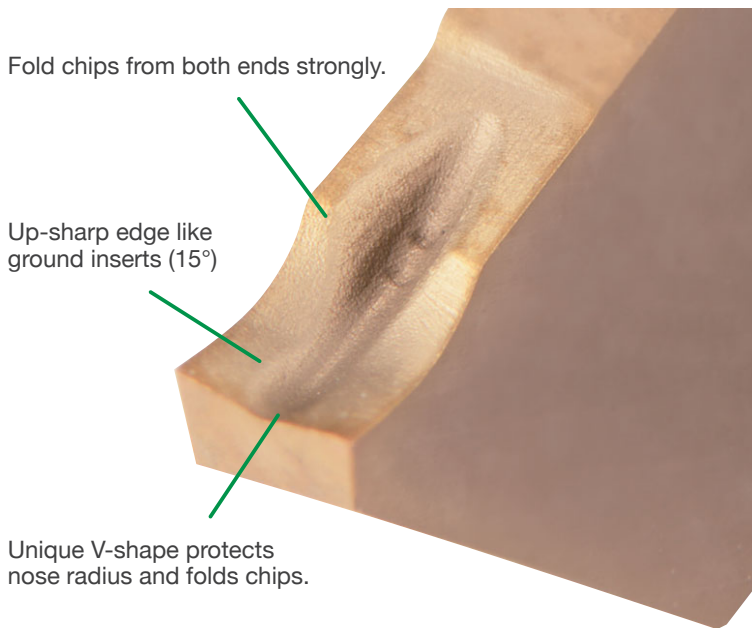

Cutting performance

Feed (mm/rev)	CX Chipbreaker		Conventional (ground chipbreaker)		Competitor (3D chipbreaker)	
	Chip	Surface finish	Chip	Surface finish	Chip	Surface finish
0.02						
0.05						
	Excellent machined surface finish		Rough surface finish		Vibration occurred due to rigidity issue	

Reference pages: Inserts → 6-85 - 6-90, Toolholders → 6-81 - 6-84

Grade 1
Insert 2
Ext. Toolholder 3
Int. Toolholder 4
Threading 5
Grooving 6
Shaper 7
Endmill 8
Drilling Tool 9
Technical Reference 10

CSV

For Cam-style machine

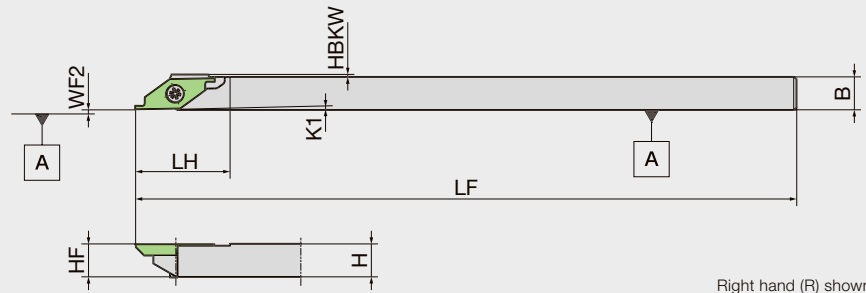

Right hand (R) shown.



Designation	H	B	LF	LH	HBKW	HF	K1	WF2	Insert
CSVR07	7	7	140	20	0.5	7	1°	0.1	CSV series, CSVF./CSVB../CSVC../CSVG../CSVT..
CSVR07GX	7	7	85	20	0.5	7	1°	0.1	CSV series, CSVF./CSVB../CSVC../CSVG../CSVT..
CSVR08	8	8	140	20	0	8	1°	0.1	CSV series, CSVF./CSVB../CSVC../CSVG../CSVT..
CSVR08GX	8	8	85	20	0	8	1°	0.1	CSV series, CSVF./CSVB../CSVC../CSVG../CSVT..
CSVR095	9.5	9.5	140	20	0	9.5	1°	0.1	CSV series, CSVF./CSVB../CSVC../CSVG../CSVT..
CSVR10	10	10	140	20	0	10	1°	0.1	CSV series, CSVF./CSVB../CSVC../CSVG../CSVT..
CSVR12	12	12	140	20	0	12	1°	0.1	CSV series, CSVF./CSVB../CSVC../CSVG../CSVT..
CSVR12GX	12	12	85	20	0	12	1°	0.1	CSV series, CSVF./CSVB../CSVC../CSVG../CSVT..
CSVL07	7	7	140	20	0.5	7	1°	0.1	CSV series, CSVF./CSVB../CSVC../CSVG../CSVT..
CSVL08	8	8	140	20	0	8	1°	0.1	CSV series, CSVF./CSVB../CSVC../CSVG../CSVT..
CSVL10	10	10	140	20	0	10	1°	0.1	CSV series, CSVF./CSVB../CSVC../CSVG../CSVT..

SPARE PARTS



Designation	Clamp screw	Wrench (for Clamp screw)
CSVR/L**	LRIS-2.5*7	CLR-15S

INSERT

CSVG without Chipbreaker (For Grooving)

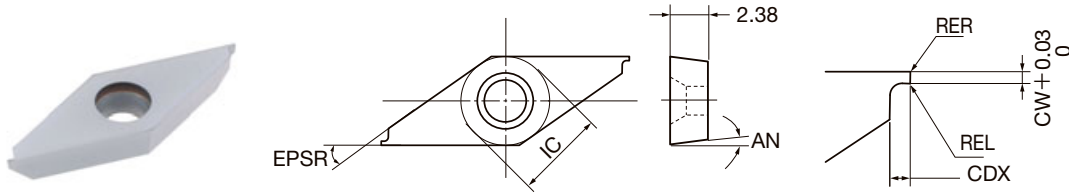

P	Steel	★
M	Stainless	☆
N	Non-ferrous	
S	Superalloys	★ : First choice
H	Hard materials	☆ : Second choice

Right hand (R) shown.

Designation	HAND	Coated		CW	APMX*	CDX	IC	AN	EPSR	REL	RER
		VM1									
CSVG11FRV025	R	●	Ⓜ	0.25	0.15	0.5	6.35	7°	35°	0	0
CSVG11FRV030	R	●	Ⓜ	0.3	0.15	0.5	6.35	7°	35°	0	0
CSVG11FRV035	R	●	Ⓜ	0.35	0.15	0.5	6.35	7°	35°	0	0
CSVG11FRV040	R	●	Ⓜ	0.4	0.15	0.5	6.35	7°	35°	0	0
CSVG11FRV045	R	●	Ⓜ	0.45	0.45	1	6.35	7°	35°	0	0
CSVG11FRV050	R	●	Ⓜ	0.5	0.45	1	6.35	7°	35°	0	0
CSVG11FRV055	R	●	Ⓜ	0.55	0.45	1	6.35	7°	35°	0	0
CSVG11FRV060	R	●	Ⓜ	0.6	0.45	1	6.35	7°	35°	0	0
CSVG11FRV065	R	●	Ⓜ	0.65	0.45	1	6.35	7°	35°	0	0
CSVG11FRV070	R	●	Ⓜ	0.7	0.45	1	6.35	7°	35°	0	0
CSVG11FRV075	R	●	Ⓜ	0.75	1.4	2	6.35	7°	35°	0	0
CSVG11FRV080	R	●	Ⓜ	0.8	1.4	2	6.35	7°	35°	0	0
CSVG11FRV085	R	●	Ⓜ	0.85	1.4	2	6.35	7°	35°	0	0
CSVG11FRV090	R	●	Ⓜ	0.9	1.4	2	6.35	7°	35°	0	0
CSVG11FRV095	R	●	Ⓜ	0.95	1.4	2	6.35	7°	35°	0	0
CSVG11FRV100	R	●	Ⓜ	1	1.4	2	6.35	7°	35°	0	0
CSVG11FRV110	R	●	Ⓜ	1.1	2.6	3	6.35	7°	35°	0	0
CSVG11FRV120	R	●	Ⓜ	1.2	2.6	3	6.35	7°	35°	0	0
CSVG11FRV130	R	●	Ⓜ	1.3	2.6	3	6.35	7°	35°	0	0
CSVG11FRV140	R	●	Ⓜ	1.4	2.6	3	6.35	7°	35°	0	0
CSVG11FRV150	R	●	Ⓜ	1.5	2.6	3	6.35	7°	35°	0	0
CSVG11FLV075	R	●	Ⓜ	0.75	1.4	2	6.35	7°	35°	0	0
CSVG11FLV095	R	●	Ⓜ	0.95	1.4	2	6.35	7°	35°	0	0
CSVG11FLV120	R	●	Ⓜ	1.2	2.6	3	6.35	7°	35°	0	0

NOTE: All angles shown are obtained when insert is set in the holder.

● : Line up

* Depth of cut maximum

Grade
Insert
Ext. Toolholder
Int. Toolholder
Threading
Grooving
Shaper
Endmill
Drilling Tool
Technical Reference

Modular head for external grooving and threading, with high pressure coolant capability

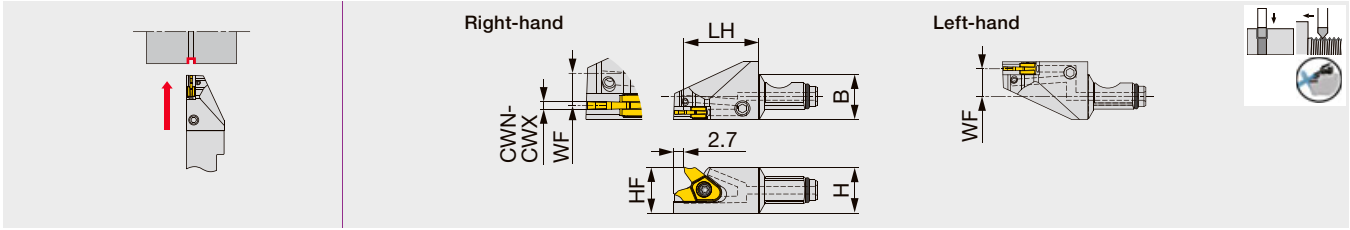

Designation	CWN	CWX	H	B	LH	HF	WF ⁽¹⁾	Insert	Torque*
QC12-SVER/L10-CHP	0.5	1	12	12	19.5	12	4.19/7.19	VG*10...	1.3

Torque*: Recommended clamping torque (N-m)

(1) "WF" indicates the distance from the reference position to the center of the cutting edge width. The first value before "/" indicates the WF for the right-hand holder and the second value after "/" for the left-hand holder.



SVER/L

External grooving and threading toolholder

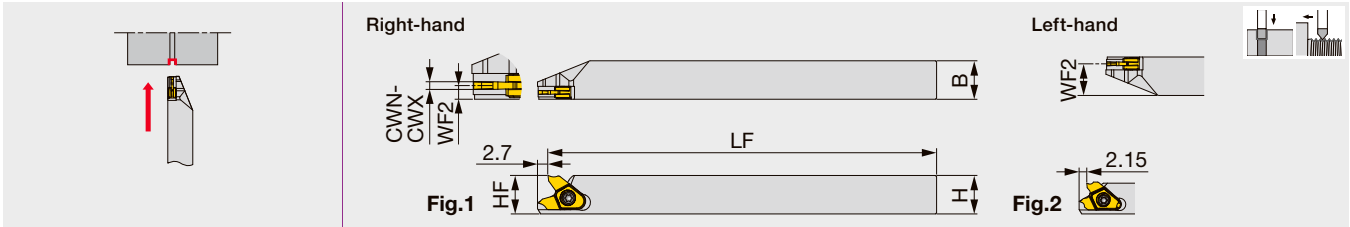

Designation	CWN	CWX	H	B	LF	HF	WF2 ⁽¹⁾	Insert	Torque*	Fig.
SVER/L0808H08	0.33	1	8	8	100	8	1.23/6.78	VGP08...	1.1	2
SVER/L1010H10	0.5	1	10	10	100	10	1.78/8.23	VG*10...	1.3	1
SVER/L1212X10	0.5	1	12	12	120	12	1.78/10.23	VG*10...	1.3	1

Torque*: Recommended clamping torque (N-m)

(1) "WF" indicates the distance from the reference position to the center of the cutting edge width. The first value before "/" indicates the WF for the right-hand holder and the second value after "/" for the left-hand holder.

SPARE PARTS

Designation	Clamping screw	Coolant plug	DirectJet plug	Wrench	Wrench 1	Wrench 2	O-ring
QC12-SVER10-CHP	CSTB-2.5L054DL	-	-	-	-	-	ORSS-0454.5X1.0NBR70
QC12-SVEL10-CHP	CSTB-2.5L054DR	-	-	-	-	-	ORSS-0454.5X1.0NBR70
SVER0808...	CSTB-2.2L053DL	-	-	T-7F	-	-	-
SVEL0808...	CSTB-2.2L053DR	-	-	T-7F	-	-	-

INSERTS

VGP08/10 (For grooving / sharp edge)

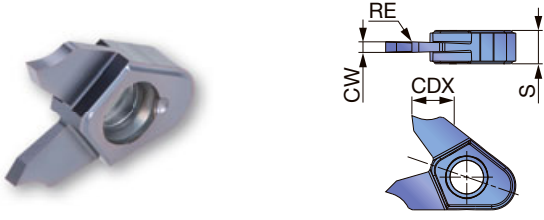

P	Steel	★							
M	Stainless	★							
K	Cast iron								
N	Non-ferrous	★							
S	Superalloys	★							
H	Hard materials								

★ : First choice

Designation	CW±0.025	RE	Coated				CDX*	CUTDIA	S
			SH725						
VGP08-033F-000	0.33	0	●				2	4	2.2
VGP08-050F-000	0.5	0	●				2	4	2.2
VGP08-075F-000	0.75	0	●				2.5	5	2.2
VGP08-100F-000	1	0	●				2.5	5	2.2
VGP10-050F-000	0.5	0	●				2.5	5	3.15
VGP10-050F-005	0.5	0.05	●				2.5	5	3.15
VGP10-075F-000	0.75	0	●				3	6	3.15
VGP10-075F-005	0.75	0.05	●				3	6	3.15
VGP10-100F-000	1	0	●				4	8	3.15
VGP10-100F-005	1	0.05	●				4	8	3.15

*Max grooving depth varies depending on workpiece diameters. See below for details.

● : Line up

Note: Max grooving depths vs workpiece diameters

To avoid tool interference with the workpiece, max grooving depths (T max) for the insert used may be smaller than the CDX values listed above depending on the workpiece diameter.

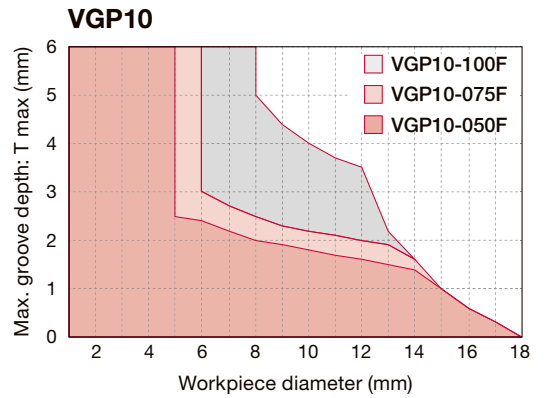
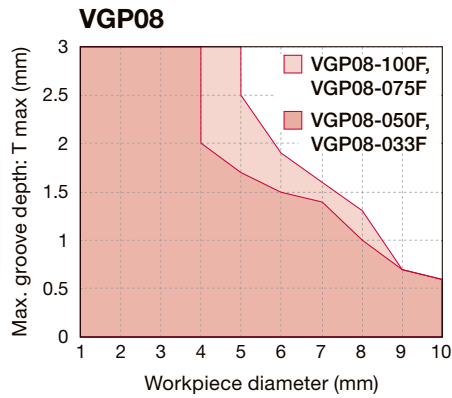
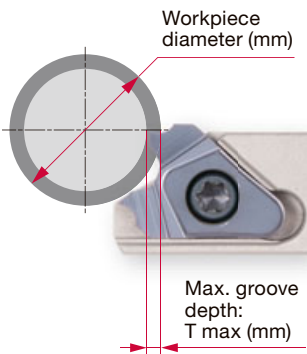

Grade 1
Insert 2
Ext. Toolholder 3
Int. Toolholder 4
Threading 5
Grooving 6
Shaper 7
Endmill 8
Drilling Tool 9
Technical Reference 10

STANDARD CUTTING CONDITIONS

Grooving

ISO	Workpiece materials	Grade	Cutting speed Vc (m/min)	Feed f (mm/rev)
P	Low carbon steels S15C, SS400, etc. C15E4, E275A, etc.	SH725	50 - 150	0.005 - 0.1
	Carbon steels, Alloy steels S55C, SCM440, etc. C55, 42CrMo4, etc.	SH725	50 - 150	0.005 - 0.1
	Free cutting steels SUH22, SUH23, etc.	SH725	50 - 150	0.005 - 0.1
M	Stainless steels SUS304, X5CrNi18-9, etc.	SH725	50 - 100	0.005 - 0.1
N	Aluminium alloys A5056, A6061, etc.	SH725	150 - 200	0.005 - 0.1
	Copper alloy C2600, C280C, etc.	SH725	100 - 200	0.005 - 0.1
S	Titanium alloys Ti-6Al-4V, etc.	SH725	30 - 80	0.005 - 0.1
	Superalloys Inconel718, etc.	SH725	30 - 80	0.005 - 0.1



GTT-OH3

Coolant through (direct connect compatible)

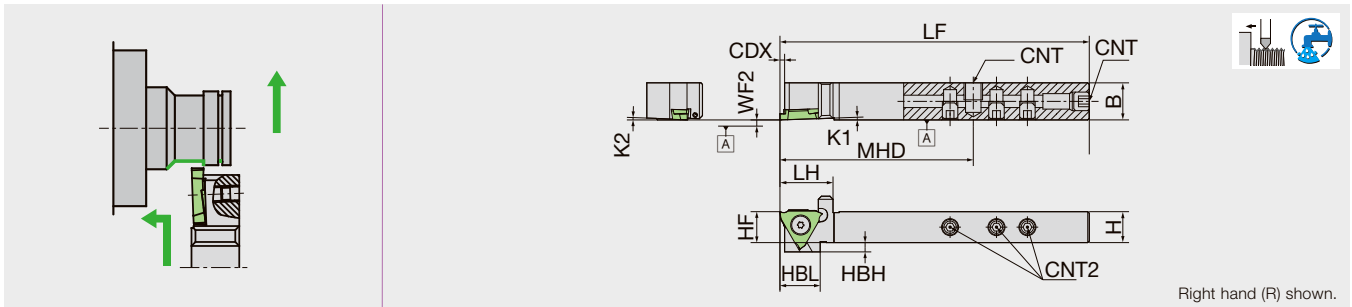

Designation	CW	H	B	LF	LH	CDX	HBH	HBL	HF	K1	K2	MHD	WF2	CNT	CNT2	Insert
GTTR1012H00-OH3	0.3 - 3	10	12	100	17.15	1.6	3	13	10	2°	2°	62.5	0	Rc1/8	M5	GT..32.. TBMH32..
GTTR16X00-OH3	0.3 - 3	16	16	120	20	1.6	-	-	16	2°	2°	78.75	0	Rc1/8	M5	GT..32.. TBMH32..

NOTE: Reference Chart of OH3 Hole Position → 10-1

SPARE PARTS

Designation	Clamp screw	Screw (for CNT)	Screw (for CNT2)	Wrench (for Clamp screw)	Wrench (for CNT2)
GTTR1012H00-OH3	LR-S-4*10PW	SS0605SC	SS0505SC	CLR-15S	LW-2.5
GTTR16X00-OH3	LR-S-4*10PW	SPR1/8	SS0505SC	CLR-15S	LW-2.5

GTT-OH2

Coolant through (direct connect compatible)

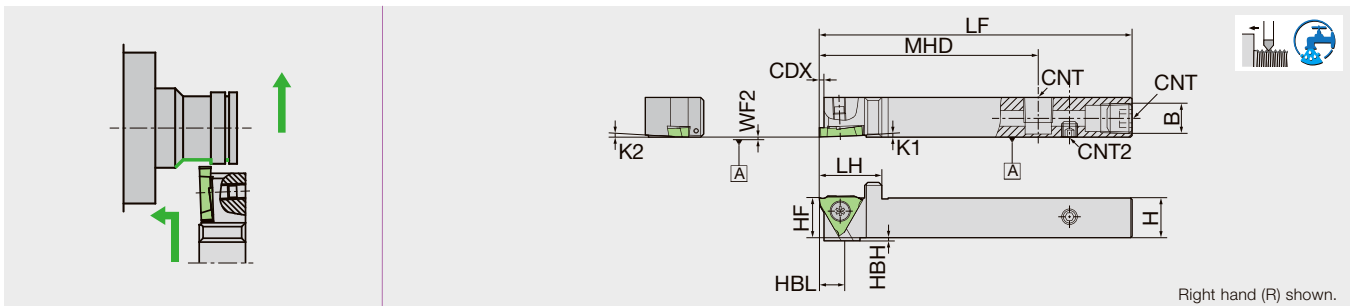

Designation	CW	H	B	LF	LH	CDX	HBH	HBL	HF	K1	K2	MHD	WF2	CNT	CNT2	Insert
GTTR12H00-OH2	0.3 - 3	12	12	100	19.5	1.6	1	13	12	2°	2°	70	0	Rc1/8	M5	GT..32.. TBMH32..
GTTR16X00-OH2	0.3 - 3	16	16	120	19.5	1.6	-	-	16	2°	2°	70	0	Rc1/8	M5	GT..32.. TBMH32..

SPARE PARTS

Designation	Clamp screw	Screw (for CNT)	Screw (for CNT2)	Wrench (for Clamp screw)	Wrench (for CNT2)
GTTR**H00-OH2	LR-S-4*10PW	SPR1/8	SS0505SC	CLR-15S	LW-2.5

Reference pages: Inserts → 6-27 - 6-33

Grade
Insert
Ext. Toolholder
Int. Toolholder
Threading
Grooving
Shaper
Endmill
Drilling Tool
Technical Reference

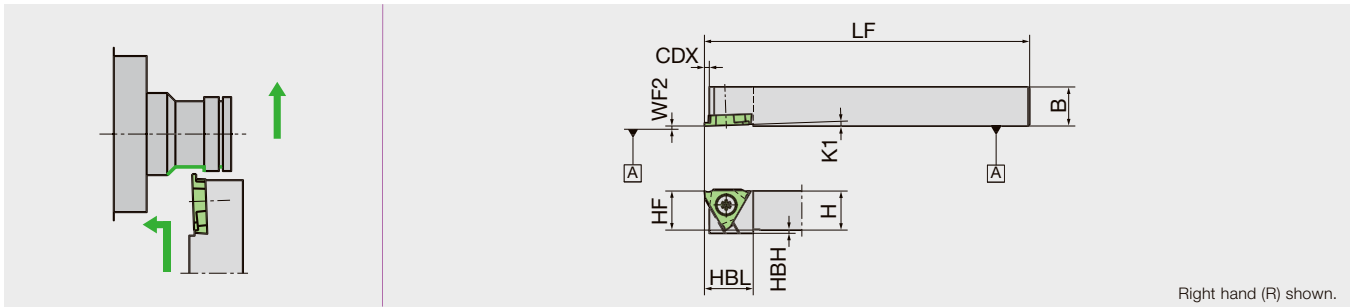

Designation	CW	H	B	LF	CDX	HBH	HBL	HF	K1	K2	WF2	Insert	
GTTR08F00	0.3 - 3	8	8	80	1.6	5	15	8	2°	2°	0	GT..32..	TBMH32..
GTTR08K00	0.3 - 3	8	8	120	1.6	5	15	8	2°	2°	0	GT..32..	TBMH32..
GTTR10F00	0.3 - 3	10	10	80	1.6	3	15	10	2°	2°	0	GT..32..	TBMH32..
GTTR10F15	1.45 - 3	10	10	80	2.7	3	15	10	2°	2°	0	GT..32..	TBMH32..
GTTR10F25	2.5 - 3	10	10	80	2.7	3	15	10	2°	2°	0	GT..32..	TBMH32..
GTTR10K00	0.3 - 3	10	10	120	1.6	3	15	10	2°	2°	0	GT..32..	TBMH32..
GTTR10K15	1.45 - 3	10	10	120	2.7	3	15	10	2°	2°	0	GT..32..	TBMH32..
GTTR10K25	2.5 - 3	10	10	120	2.7	3	15	10	2°	2°	0	GT..32..	TBMH32..
GTTR12F00	0.3 - 3	12	12	80	1.6	1	15	12	2°	2°	0	GT..32..	TBMH32..
GTTR12F15	1.45 - 3	12	12	80	2.7	1	15	12	2°	2°	0	GT..32..	TBMH32..
GTTR12F25	2.5 - 3	12	12	80	2.7	1	15	12	2°	2°	0	GT..32..	TBMH32..
GTTR12K00	0.3 - 3	12	12	120	1.6	1	15	12	2°	2°	0	GT..32..	TBMH32..
GTTR12K15	1.45 - 3	12	12	120	2.7	1	15	12	2°	2°	0	GT..32..	TBMH32..
GTTR12K25	2.5 - 3	12	12	120	2.7	1	15	12	2°	2°	0	GT..32..	TBMH32..
GTTR16H00	0.3 - 3	16	16	100	1.6	-	-	16	2°	2°	0	GT..32..	TBMH32..
GTTR16H15	1.45 - 3	16	16	100	2.7	-	-	16	2°	2°	0	GT..32..	TBMH32..
GTTR16H25	2.5 - 3	16	16	100	2.7	-	-	16	2°	2°	0	GT..32..	TBMH32..
GTTR16K00	0.3 - 3	16	16	120	1.6	-	-	16	2°	2°	0	GT..32..	TBMH32..
GTTR16K15	1.45 - 3	16	16	120	2.7	-	-	16	2°	2°	0	GT..32..	TBMH32..
GTTR16K25	2.5 - 3	16	16	120	2.7	-	-	16	2°	2°	0	GT..32..	TBMH32..
GTTR20K00	0.3 - 3	20	20	125	2.7	-	-	20	2°	2°	0	GT..32..	TBMH32..
GTTR25M00	0.3 - 3	25	25	150	2.7	-	-	25	2°	2°	0	GT..32..	TBMH32..
GTTL08F00	0.3 - 3	8	8	80	1.6	5	15	8	2°	2°	0	GT..32..	
GTTL08K00	0.3 - 3	8	8	120	1.6	5	15	8	2°	2°	0	GT..32..	
GTTL10F00	0.3 - 3	10	10	80	1.6	3	15	10	2°	2°	0	GT..32..	
GTTL10F15	1.45 - 3	10	10	80	2.7	3	15	10	2°	2°	0	GT..32..	
GTTL10F25	2.5 - 3	10	10	80	2.7	3	15	10	2°	2°	0	GT..32..	
GTTL10K00	0.3 - 3	10	10	120	1.6	3	15	10	2°	2°	0	GT..32..	
GTTL10K15	1.45 - 3	10	10	120	2.7	3	15	10	2°	2°	0	GT..32..	
GTTL10K25	2.5 - 3	10	10	120	2.7	3	15	10	2°	2°	0	GT..32..	
GTTL12F00	0.3 - 3	12	12	80	1.6	1	15	12	2°	2°	0	GT..32..	
GTTL12F15	1.45 - 3	12	12	80	2.7	1	15	12	2°	2°	0	GT..32..	
GTTL12F25	2.5 - 3	12	12	80	2.7	1	15	12	2°	2°	0	GT..32..	
GTTL12K00	0.3 - 3	12	12	120	1.6	1	15	12	2°	2°	0	GT..32..	
GTTL12K15	1.45 - 3	12	12	120	2.7	1	15	12	2°	2°	0	GT..32..	
GTTL12K25	2.5 - 3	12	12	120	2.7	1	15	12	2°	2°	0	GT..32..	
GTTL16H00	0.3 - 3	16	16	100	1.6	-	-	16	2°	2°	0	GT..32..	
GTTL16H15	1.45 - 3	16	16	100	2.7	-	-	16	2°	2°	0	GT..32..	
GTTL16H25	2.5 - 3	16	16	100	2.7	-	-	16	2°	2°	0	GT..32..	
GTTL16K00	0.3 - 3	16	16	120	1.6	-	-	16	2°	2°	0	GT..32..	
GTTL16K15	1.45 - 3	16	16	120	2.7	-	-	16	2°	2°	0	GT..32..	
GTTL16K25	2.5 - 3	16	16	120	2.7	-	-	16	2°	2°	0	GT..32..	
GTTL20K00	0.3 - 3	20	20	125	1.6	-	-	20	2°	2°	0	GT..32..	
GTTL25M00	0.3 - 3	25	25	150	1.6	-	-	25	2°	2°	0	GT..32..	

SPARE PARTS



Designation	Clamp screw	Wrench (for Clamp screw)
GTTR/L**	LR-S-4*10PW	CLR-15S
GTTL08**	LR-S-4*5.8	CLR-15S

Reference pages: Inserts → 6-27 - 6-33

CH-GTT

For horizontal gang style tool post

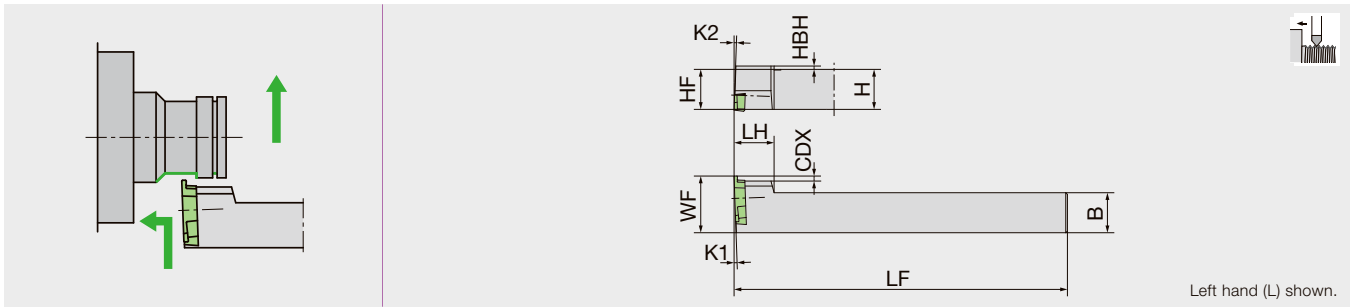

Designation	CW	H	B	LF	LH	CDX	HBH	HF	K1	K2	WF	Insert	
CH-GTTL10H00	0.3 - 3	10	10	100	12	1.5	3	10	2°	2°	15	GT..32..	TBMH32..
CH-GTTL12H00	0.3 - 3	12	12	100	12	1.5	1	12	2°	2°	17	GT..32..	TBMH32..
CH-GTTL16H00	0.3 - 3	16	16	100	12	1.5	-	16	2°	2°	21	GT..32..	TBMH32..

Use a right-handed (R) insert

SPARE PARTS



Designation	Clamp screw	Wrench (for Clamp screw)
CH-GTTL**	LR-S-4*9	RLR-20S

Y-GTT-OH

Y-axis coolant through holders

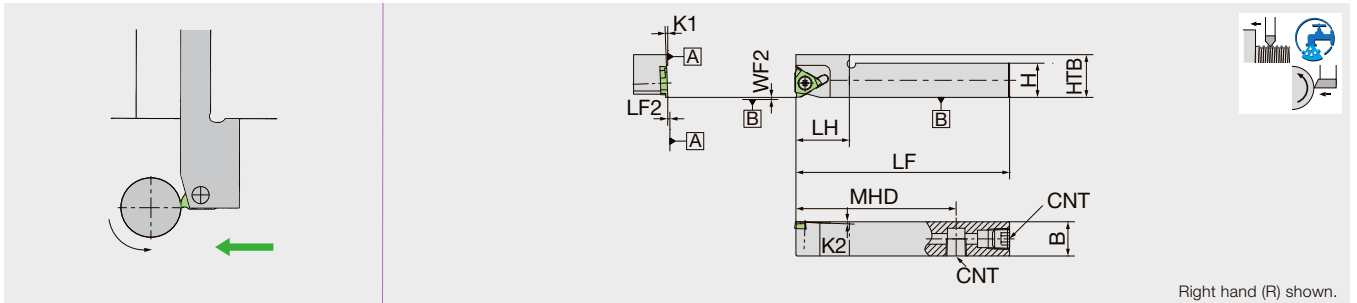

Designation	CW	H	B	LF	LH	HTB	K1	K2	LF2	MHD	WF2	CNT	Insert	
Y-GTTR12H00S-OH	0.3 - 3	12	12	100	20	20	2°	2°	0	75	0	Rc1/8	GT..32..	TBMH32..
Y-GTTR16H00-OH	0.3 - 3	16	16	100	25	20	2°	2°	0	75	0	Rc1/8	GT..32..	TBMH32..

NOTE: Use a right-handed (R) insert.

NOTE: There is a risk of interference with the Y-axis holder depending on the combination of the maximum workpiece diameter and machining diameter.

→A012

SPARE PARTS



Designation	Clamp screw	Screw (for CNT)	Wrench (for Clamp screw)
Y-GTTR**H00S-OH	LR-S-4*10PW	SPR1/8	CLR-15S

Reference pages: Inserts → [6-27](#) - [6-33](#)

Grade
Insert
Ext. Toolholder
Int. Toolholder
Threading
Grooving
Shaper
Endmill
Drilling Tool
Technical Reference

1
2
3
4
5
6
7
8
9
10

Y-GTT

Y-axis

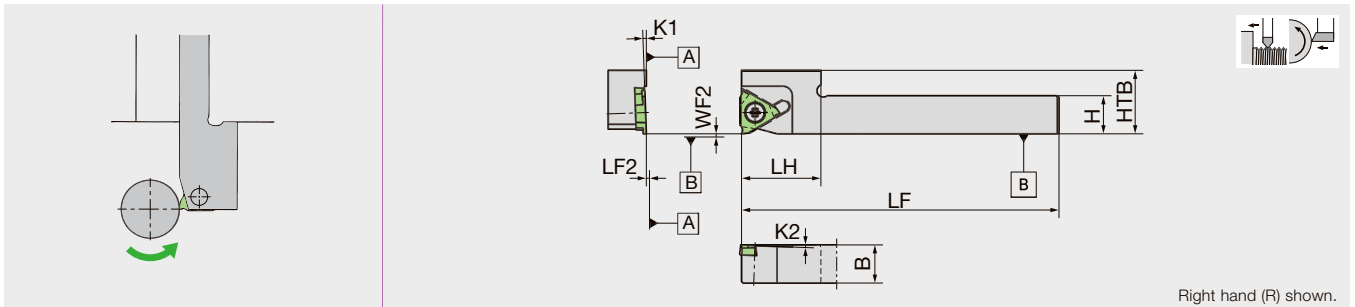

Right hand (R) shown.

Designation	CW	H	B	LF	LH	CDX	HTB	K1	K2	LF2	WF2	Insert
Y-GTTR10MS	0.3 - 3	10	10	120	22	1.6	20	2°	2°	0	0	GT..32.. TBMH32..
Y-GTTR10S	0.3 - 3	10	10	120	20	1.6	20	2°	2°	0	0	GT..32.. TBMH32..
Y-GTTR12MS	0.3 - 3	12	12	120	22	1.6	20	2°	2°	0	0	GT..32.. TBMH32..
Y-GTTR12S	0.3 - 3	12	12	120	20	1.6	20	2°	2°	0	0	GT..32.. TBMH32..

NOTE: Use a right-handed (R) insert.

NOTE: There is a risk of interference with the Y-axis holder depending on the combination of the maximum workpiece diameter and machining diameter.

→A012

SPARE PARTS



Designation	Clamp screw	Wrench (for Clamp screw)
Y-GTTR**	LR-S-4*10PW	CLR-15S

DS-GTT

DS Toolholders / For sleeve tool post

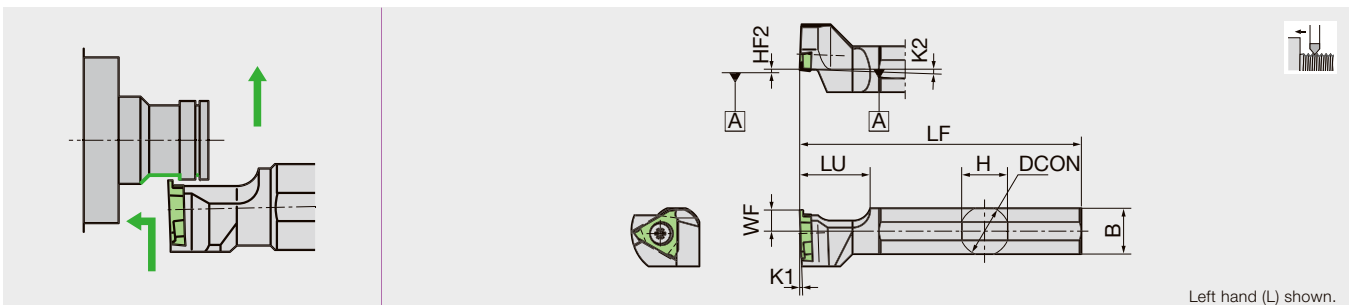

Left hand (L) shown.

Designation	CW	H	B	LF	CDX	DCON	HF2	K1	K2	LU	WF	Insert
DS-GTTL15H	0.3 - 3	15	15	100	1.6	15.875	0	2°	2°	19	6	GT..32.. TBMH32..
DS-GTTL16X	0.3 - 3	15	15	95	1.6	16	0	2°	2°	19	6	GT..32.. TBMH32..
DS-GTTL19	0.3 - 3	18	18	120	1.6	19.05	0	2°	2°	19	6	GT..32.. TBMH32..
DS-GTTL20	0.3 - 3	19	19	120	1.6	20	0	2°	2°	19	6	GT..32.. TBMH32..
DS-GTTL22	0.3 - 3	21	21	120	1.6	22	0	2°	2°	19	6	GT..32.. TBMH32..
DS-GTTL25	0.3 - 3	24	24	120	1.6	25.4	0	2°	2°	19	10	GT..32.. TBMH32..
DS-GTTL25-MET	0.3 - 3	24	24	150	1.6	25	0	2°	2°	19	10	GT..32.. TBMH32..
DS-GTTL32	0.3 - 3	30	30	150	1.6	32	0	2°	2°	19	10	GT..32.. TBMH32..

NOTE: Use a right-handed (R) insert.

SPARE PARTS



Designation	Clamp screw	Wrench (for Clamp screw)
DS-GTTL**	LR-S-4*9	RLR-20S

Reference pages: Inserts → [6-27 - 6-33](#)

INSERT

GTMH32-GX

Side Turning / 3D mold chipbreaker

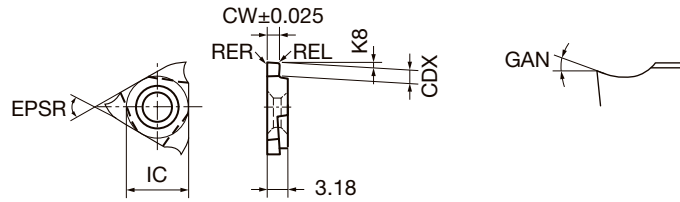

Right hand (R) shown.

P	Steel	★	☆	☆
M	Stainless	☆	★	☆
N	Non-ferrous	☆	☆	★
S	Superalloys	★	☆	☆
H	Hard materials	★	☆	☆

★ : First choice
☆ : Second choice

Designation	HAND	Coated			CW	APMX*	CDX	IC	EPSR	GAN	K8	REL	RER
		DM4	ST4	TM4									
GTMH32033RGX	R	●	●	●	0.33	0.25	0.6	9.525	60°	17°	2°	0.05	0.05
GTMH32043RGX	R	●	●	●	0.43	0.9	1.2	9.525	60°	17°	2°	0.05	0.05
GTMH32050RGX	R	●	●	●	0.5	0.9	1.2	9.525	60°	17°	2°	0.05	0.05
GTMH32053RGX	R	●	●	●	0.53	0.9	1.2	9.525	60°	17°	2°	0.05	0.05
GTMH32075RGX	R	●	●	●	0.75	1.6	2	9.525	60°	17°	2°	0.05	0.05
GTMH32095RGX	R	●	●	●	0.95	1.6	2	9.525	60°	17°	2°	0.05	0.05
GTMH32100RGX	R	●	●	●	1	1.6	2	9.525	60°	17°	2°	0.05	0.05
GTMH32100RGX01	R	●	●	●	1	1.6	2	9.525	60°	17°	2°	0.1	0.1
GTMH32150RGX	R	●	●	●	1.5	2.7	3	9.525	60°	17°	2°	0.05	0.05
GTMH32150RGX01	R	●	●	●	1.5	2.7	3	9.525	60°	17°	2°	0.1	0.1
GTMH32150RGX02	R	●	●	●	1.5	2.7	3	9.525	60°	17°	2°	0.2	0.2
GTMH32200RGX	R	●	●	●	2	2.7	3	9.525	60°	17°	2°	0.05	0.05
GTMH32200RGX01	R	●	●	●	2	2.7	3	9.525	60°	17°	2°	0.1	0.1
GTMH32200RGX02	R	●	●	●	2	2.7	3	9.525	60°	17°	2°	0.2	0.2
GTMH32300RGX	R	●	●	●	3	2.7	3	9.525	60°	17°	2°	0.05	0.05
GTMH32300RGX02	R	●	●	●	3	2.7	3	9.525	60°	17°	2°	0.2	0.2

* Depth of cut maximum

● : Line up

INSERT

GTMX32-T

Side Turning

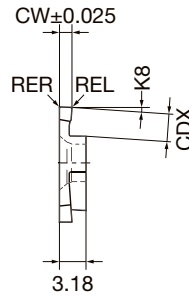
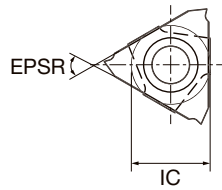
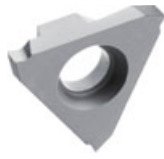

Right hand (R) shown.

P	Steel	★	☆
M	Stainless	☆	★
N	Non-ferrous		
S	Superalloys	☆	★
H	Hard materials	★	☆

★ : First choice
☆ : Second choice



Designation	HAND	Coated		CW	APMX*	CDX	IC	EPSR	GAN	K8	REL	RER
		QM3	DT4									
GTMX32030RT	R	●	●	0.3	0.25	0.6	9.525	60°	14°	2°	0.05	0.05
GTMX32033RT	R	●		0.33	0.25	0.6	9.525	60°	14°	2°	0.05	0.05
GTMX32043RT	R	●	●	0.43	0.9	1.2	9.525	60°	14°	2°	0.05	0.05
GTMX32050RT	R	●	●	0.5	0.9	1.2	9.525	60°	14°	2°	0.05	0.05
GTMX32053RT	R	●		0.53	0.9	1.2	9.525	60°	14°	2°	0.05	0.05
GTMX32065RT	R	●	●	0.65	0.9	1.2	9.525	60°	14°	2°	0.05	0.05
GTMX32075RT	R	●	●	0.75	1.6	2	9.525	60°	14°	2°	0.05	0.05
GTMX32080RT	R	●	●	0.8	1.6	2	9.525	60°	14°	2°	0.05	0.05
GTMX32095RT	R	●	●	0.95	1.6	2	9.525	60°	14°	2°	0.05	0.05
GTMX32100RT	R	●	●	1	1.6	2	9.525	60°	14°	2°	0.05	0.05
GTMX32110RT	R	●		1.1	1.6	2	9.525	60°	14°	2°	0.05	0.05
GTMX32120RT	R	●	●	1.2	1.6	2	9.525	60°	14°	2°	0.05	0.05
GTMX32125RT	R	●	●	1.25	1.6	2	9.525	60°	14°	2°	0.05	0.05
GTMX32130RT	R	●	●	1.3	1.6	2	9.525	60°	14°	2°	0.05	0.05
GTMX32140RT	R	●	●	1.4	1.6	2	9.525	60°	14°	2°	0.05	0.05
GTMX32145RT	R	●		1.45	2.7	3	9.525	60°	14°	2°	0.05	0.05
GTMX32150RT	R	●	●	1.5	2.7	3	9.525	60°	14°	2°	0.05	0.05
GTMX32160RT	R	●	●	1.6	2.7	3	9.525	60°	14°	2°	0.05	0.05
GTMX32175RT	R	●	●	1.75	2.7	3	9.525	60°	14°	2°	0.05	0.05
GTMX32180RT	R	●	●	1.8	2.7	3	9.525	60°	14°	2°	0.05	0.05
GTMX32200RT	R	●	●	2	2.7	3	9.525	60°	14°	2°	0.05	0.05
GTMX32250RT	R	●	●	2.5	2.7	3	9.525	60°	14°	2°	0.05	0.05
GTMX32300RT	R	●	●	3	2.7	3	9.525	60°	14°	2°	0.05	0.05
GTMX32100RT01	R	●	●	1	1.6	2	9.525	60°	14°	2°	0.1	0.1
GTMX32120RT01	R	●	●	1.2	1.6	2	9.525	60°	14°	2°	0.1	0.1
GTMX32150RT01	R	●	●	1.5	2.7	3	9.525	60°	14°	2°	0.1	0.1
GTMX32200RT01	R	●	●	2	2.7	3	9.525	60°	14°	2°	0.1	0.1
GTMX32250RT01	R	●	●	2.5	2.7	3	9.525	60°	14°	2°	0.1	0.1
GTMX32150RT02	R	●	●	1.5	2.7	3	9.525	60°	14°	2°	0.2	0.2
GTMX32200RT02	R	●	●	2	2.7	3	9.525	60°	14°	2°	0.2	0.2
GTMX32250RT02	R	●	●	2.5	2.7	3	9.525	60°	14°	2°	0.2	0.2
GTMX32300RT02	R	●	●	3	2.7	3	9.525	60°	14°	2°	0.2	0.2
GTMX32050LT	L			0.5	0.9	1.2	9.525	60°	14°	2°	0.05	0.05
GTMX32075LT	L	●	●	0.75	1.6	2	9.525	60°	14°	2°	0.05	0.05
GTMX32095LT	L	●	●	0.95	1.6	2	9.525	60°	14°	2°	0.05	0.05
GTMX32150LT	L	●	●	1.5	2.7	3	9.525	60°	14°	2°	0.05	0.05
GTMX32200LT	L	●	●	2	2.7	3	9.525	60°	14°	2°	0.05	0.05
GTMX32250LT	L	●	●	2.5	2.7	3	9.525	60°	14°	2°	0.05	0.05
GTMX32200LT01	L	●	●	2	2.7	3	9.525	60°	14°	2°	0.1	0.1

* Depth of cut maximum

● : Line up

Reference pages: Toolholders → [6-23](#) - [6-26](#)

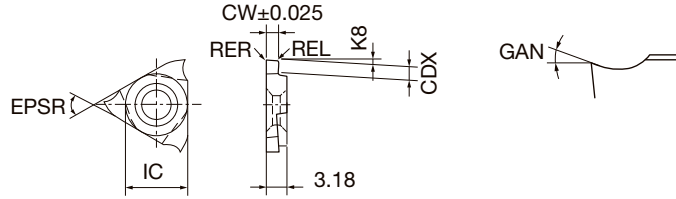

Right hand (R) shown.

P	Steel	☆
M	Stainless	★
N	Non-ferrous	★
S	Superalloys	
H	Hard materials	

★ : First choice
☆ : Second choice

Designation	HAND	Coated	CW	APMX*	CDX	IC	EPSR	GAN	K8	REL	RER
		ZM3									
GTMH32033RE	R	●	0.33	0.3	0.6	9.525	60°	20°	2°	0.03	0.03
GTMH32043RE	R	●	0.43	0.9	1.2	9.525	60°	20°	2°	0.03	0.03
GTMH32053RE	R	●	0.53	0.9	1.2	9.525	60°	20°	2°	0.05	0.05
GTMH32075RE	R	●	0.75	1.6	2	9.525	60°	20°	2°	0.05	0.05
GTMH32077RE	R	●	0.77	1.6	2	9.525	60°	20°	2°	0.05	0.05
GTMH32095RE	R	●	0.95	1.6	2	9.525	60°	20°	2°	0.05	0.05
GTMH32097RE	R	●	0.97	1.6	2	9.525	60°	20°	2°	0.05	0.05
GTMH32100RE	R	●	1	1.6	2	9.525	60°	20°	2°	0.05	0.05
GTMH32103RE	R	●	1.03	1.6	2	9.525	60°	20°	2°	0.05	0.05
GTMH32120RE	R	●	1.2	1.6	2	9.525	60°	20°	2°	0.05	0.05
GTMH32125RE	R	●	1.25	1.6	2	9.525	60°	20°	2°	0.05	0.05
GTMH32140RE	R	●	1.4	1.6	2	9.525	60°	20°	2°	0.05	0.05
GTMH32145RE	R	●	1.45	2.7	3	9.525	60°	20°	2°	0.05	0.05
GTMH32150RE	R	●	1.5	2.7	3	9.525	60°	20°	2°	0.05	0.05
GTMH32175RE	R	●	1.75	2.7	3	9.525	60°	20°	2°	0.05	0.05
GTMH32180RE	R	●	1.8	2.7	3	9.525	60°	20°	2°	0.05	0.05
GTMH32200RE	R	●	2	2.7	3	9.525	60°	20°	2°	0.05	0.05
GTMH32225RE	R	●	2.25	2.7	3	9.525	60°	20°	2°	0.05	0.05
GTMH32250RE	R	●	2.5	2.7	3	9.525	60°	20°	2°	0.05	0.05
GTMH32275RE	R	●	2.75	2.7	3	9.525	60°	20°	2°	0.05	0.05
GTMH32300RE	R	●	3	2.7	3	9.525	60°	20°	2°	0.05	0.05
GTMH32100RE01	R	●	1	1.6	2	9.525	60°	20°	2°	0.1	0.1
GTMH32120RE01	R	●	1.2	1.6	2	9.525	60°	20°	2°	0.1	0.1
GTMH32150RE01	R	●	1.5	2.7	3	9.525	60°	20°	2°	0.1	0.1
GTMH32200RE01	R	●	2	2.7	3	9.525	60°	20°	2°	0.1	0.1
GTMH32033LE	L	●	0.33	0.3	0.6	9.525	60°	20°	2°	0.03	0.03
GTMH32043LE	L	●	0.43	0.9	1.2	9.525	60°	20°	2°	0.03	0.03
GTMH32053LE	L	●	0.53	0.9	1.2	9.525	60°	20°	2°	0.05	0.05
GTMH32075LE	L	●	0.75	1.6	2	9.525	60°	20°	2°	0.05	0.05
GTMH32077LE	L	●	0.77	1.6	2	9.525	60°	20°	2°	0.05	0.05
GTMH32095LE	L	●	0.95	1.6	2	9.525	60°	20°	2°	0.05	0.05
GTMH32097LE	L	●	0.97	1.6	2	9.525	60°	20°	2°	0.05	0.05
GTMH32100LE	L	●	1	1.6	2	9.525	60°	20°	2°	0.05	0.05
GTMH32103LE	L	●	1.03	1.6	2	9.525	60°	20°	2°	0.05	0.05

* Depth of cut maximum

● : Line up

INSERT

GTMH32-E

P	Steel	☆	
M	Stainless	★	
N	Non-ferrous	★	
S	Superalloys		
H	Hard materials		

★ : First choice
☆ : Second choice

Designation	HAND	Coated		CW	APMX*	CDX	IC	EPSR	GAN	K8	REL	RER
		ZM3										
GTMH32120LE	L	●		1.2	1.6	2	9.525	60°	20°	2°	0.05	0.05
GTMH32140LE	L	●		1.4	1.6	2	9.525	60°	20°	2°	0.05	0.05
GTMH32150LE	L	●		1.5	2.7	3	9.525	60°	20°	2°	0.05	0.05
GTMH32180LE	L	●		1.8	2.7	3	9.525	60°	20°	2°	0.05	0.05
GTMH32200LE	L	●		2	2.7	3	9.525	60°	20°	2°	0.05	0.05
GTMH32225LE	L	●		2.25	2.7	3	9.525	60°	20°	2°	0.05	0.05
GTMH32250LE	L	●		2.5	2.7	3	9.525	60°	20°	2°	0.05	0.05
GTMH32275LE	L	●		2.75	2.7	3	9.525	60°	20°	2°	0.05	0.05
GTMH32300LE	L	●		3	2.7	3	9.525	60°	20°	2°	0.05	0.05
GTMH32100LE01	L	●		1	1.6	2	9.525	60°	20°	2°	0.1	0.1
GTMH32120LE01	L	●		1.2	1.6	2	9.525	60°	20°	2°	0.1	0.1
GTMH32150LE01	L	●		1.5	2.7	3	9.525	60°	20°	2°	0.1	0.1
GTMH32200LE01	L	●		2	2.7	3	9.525	60°	20°	2°	0.1	0.1

* Depth of cut maximum

● : Line up



GTMH32-SSH

Short type / Flat top chipbreaker

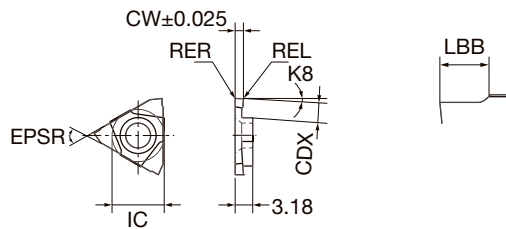
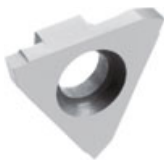

P	Steel		
M	Stainless		
N	Non-ferrous	★	
S	Superalloys		
H	Hard materials		

★ : First choice
☆ : Second choice

Designation	HAND	Uncoated		CW	APMX*	CDX	IC	EPSR	GAN	K8	LBB	REL	RER
		KM1											
GTMH32100RSSH	R	●		1	1.6	2	9.525	60°	20°	2°	1.5	0.05	0.05
GTMH32150RSSH	R	●	Ⓜ	1.5	2.7	3	9.525	60°	20°	2°	1.5	0.05	0.05
GTMH32200RSSH	R	●		2	2.7	3	9.525	60°	20°	2°	1.5	0.05	0.05

* Depth of cut maximum

● : Line up

Reference pages: Toolholders → [6-23](#) - [6-26](#)

GTMX32-SS

Short type / Flat top chipbreaker

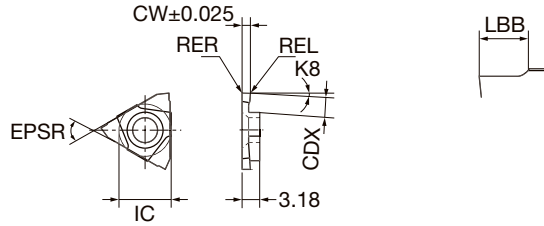

Right hand (R) shown.

P	Steel	☆
M	Stainless	★
N	Non-ferrous	★
S	Superalloys	
H	Hard materials	

★ : First choice
☆ : Second choice

Designation	HAND	Coated	CW	APMX*	CDX	IC	EPSR	GAN	K8	LBB	REL	RER
		ZM3										
GTMX32100RSS	R	●	1	1.6	2	9.525	60°	0°	2°	1.5	0.05	0.05
GTMX32150RSS	R	●	1.5	2.7	3	9.525	60°	0°	2°	1.5	0.05	0.05
GTMX32200RSS	R	●	2	2.7	3	9.525	60°	0°	2°	1.5	0.05	0.05

* Depth of cut maximum

● : Line up

GTMX32-LS

Long type / Flat top chipbreaker

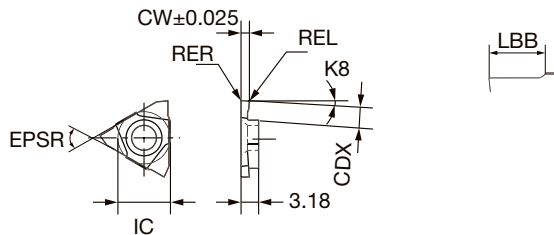

Right hand (R) shown.

P	Steel	☆
M	Stainless	★
N	Non-ferrous	★
S	Superalloys	
H	Hard materials	

★ : First choice
☆ : Second choice

Designation	HAND	Coated	CW	APMX*	CDX	IC	EPSR	GAN	K8	LBB	REL	RER
		ZM3										
GTMX32100RLS	R	●	1	1.6	2	9.525	60°	0°	2°	3	0.05	0.05
GTMX32150RLS	R	●	1.5	2.7	3	9.525	60°	0°	2°	3	0.05	0.05
GTMX32200RLS	R	●	2	2.7	3	9.525	60°	0°	2°	3	0.05	0.05

* Depth of cut maximum

● : Line up

Reference pages: Toolholders → 6-23 - 6-26

Grade
Insert
Ext. Toolholder
Int. Toolholder
Threading
Grooving
Shaper
Endmill
Drilling Tool
Technical Reference

INSERT
GTMH32-VT

Side Turning

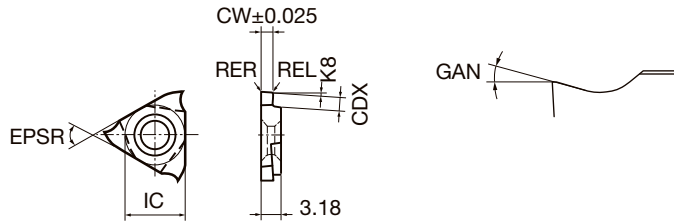

Right hand (R) shown.

P	Steel	★
M	Stainless	☆
N	Non-ferrous	★
S	Superalloys	☆
H	Hard materials	

★ : First choice
☆ : Second choice



Designation	HAND	Coated		CW	APMX*	CDX	IC	EPSR	GAN	K8	REL	RER
		VM1										
GTMH32033RVT	R	●	Ⓜ	0.33	0.25	0.6	9.525	60°	14°	2°	0	0
GTMH32043RVT	R	●	Ⓜ	0.43	0.9	1.2	9.525	60°	14°	2°	0	0
GTMH32053RVT	R	●	Ⓜ	0.53	1.6	2	9.525	60°	14°	2°	0	0
GTMH32065RVT	R	●	Ⓜ	0.65	1.6	2	9.525	60°	14°	2°	0	0
GTMH32075RVT	R	●	Ⓜ	0.75	1.6	2	9.525	60°	14°	2°	0	0
GTMH32080RVT	R	●	Ⓜ	0.8	1.6	2	9.525	60°	14°	2°	0	0
GTMH32085RVT	R	●	Ⓜ	0.85	1.6	2	9.525	60°	14°	2°	0	0
GTMH32095RVT	R	●	Ⓜ	0.95	1.6	2	9.525	60°	14°	2°	0	0
GTMH32100RVT	R	●	Ⓜ	1	1.6	2	9.525	60°	14°	2°	0	0
GTMH32110RVT	R	●	Ⓜ	1.1	1.6	2	9.525	60°	14°	2°	0	0
GTMH32120RVT	R	●	Ⓜ	1.2	1.6	2	9.525	60°	14°	2°	0	0
GTMH32130RVT	R	●	Ⓜ	1.3	1.6	2	9.525	60°	14°	2°	0	0
GTMH32140RVT	R	●	Ⓜ	1.4	1.6	2	9.525	60°	14°	2°	0	0
GTMH32150RVT	R	●	Ⓜ	1.5	2.7	3	9.525	60°	14°	2°	0	0
GTMH32200RVT	R	●	Ⓜ	2	2.7	3	9.525	60°	14°	2°	0	0

* Depth of cut maximum

● : Line up

GTMH32

Full radius style

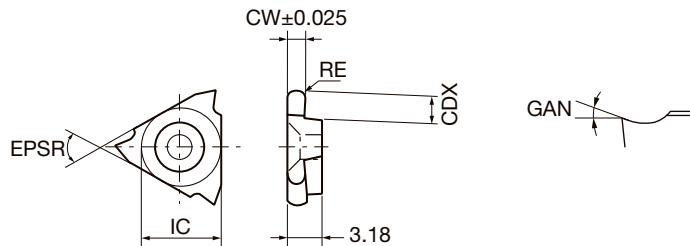

Right hand (R) shown.

P	Steel	☆
M	Stainless	★
N	Non-ferrous	★
S	Superalloys	☆
H	Hard materials	

★ : First choice
☆ : Second choice

Designation	HAND	Coated		CW	APMX*	CDX	IC	EPSR	GAN	RE
		ZM3								
GTMH32050RE025	R	●		0.5	0.9	1.2	9.525	60°	20°	0.25
GTMH32070RE035	R	●		0.7	1.6	2	9.525	60°	20°	0.35
GTMH32100RE05	R	●		1	1.6	2	9.525	60°	20°	0.5
GTMH32150RE075	R	●		1.5	2.7	3	9.525	60°	20°	0.75
GTMH32200RE10	R	●		2	2.7	3	9.525	60°	20°	1
GTMH32250RE125	R	●		2.5	2.7	3	9.525	60°	20°	1.25
GTMH32300RE15	R	●		3	2.7	3	9.525	60°	20°	1.5

* Depth of cut maximum

● : Line up

GTMX32-V90

90 Degree V-style

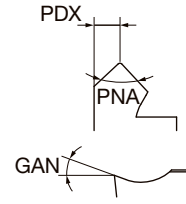
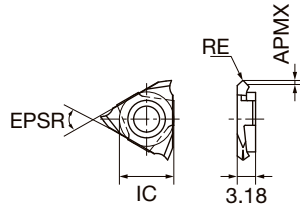

Right hand (R) shown.

P	Steel	☆
M	Stainless	★
N	Non-ferrous	★
S	Superalloys	
H	Hard materials	

★ : First choice
☆ : Second choice

Designation	HAND	Coated	APMX*	IC	EPSR	GAN	PDX	PNA	RE
		TM4							
GTMX32V90R005	R	●	0.35	9.525	60°	20°	0.5	90°	0.05
GTMX32V90R010	R	●	0.7	9.525	60°	20°	1	90°	0.1

* Depth of cut maximum

● : Line up

NGTN

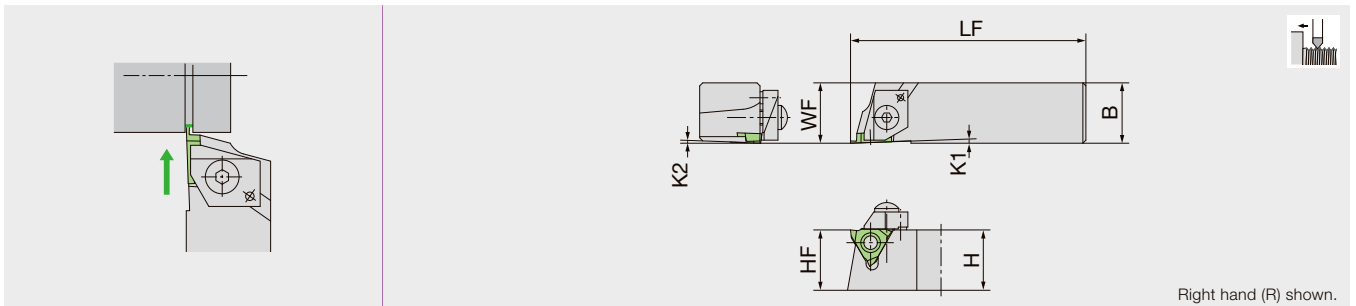

Right hand (R) shown.

Designation	CW	H	B	LF	CDX	HF	K1	K2	WF	Insert
NGTNR161643-20	2 - 5.5	16	16	78	4.5	16	2°	2°	16	GT..43..
NGTNR161643-35	3.5 - 5.5	16	16	78	4.5	16	2°	2°	16	GT..43..
NGTNL161643-20	2 - 5.5	16	16	78	4.5	16	2°	2°	16	GT..43..
NGTNL161643-35	3.5 - 5.5	16	16	78	4.5	16	2°	2°	16	GT..43..

SPARE PARTS



Designation	Clamp	Clamp screw	Spring	Wrench (for Clamp screw)
NGTNR/L161643-**	CPR5S	AOS-5*25	ASG-5	LW-2.5

Reference pages: GTMX32-V90: Toolholders → 6-23 - 6-26
NGTN: Toolholders → 6-35 - 6-36

Grade
Insert
Ext. Toolholder
Int. Toolholder
Threading
Grooving
Shaper
Endmill
Drilling Tool
Technical Reference

NGTB

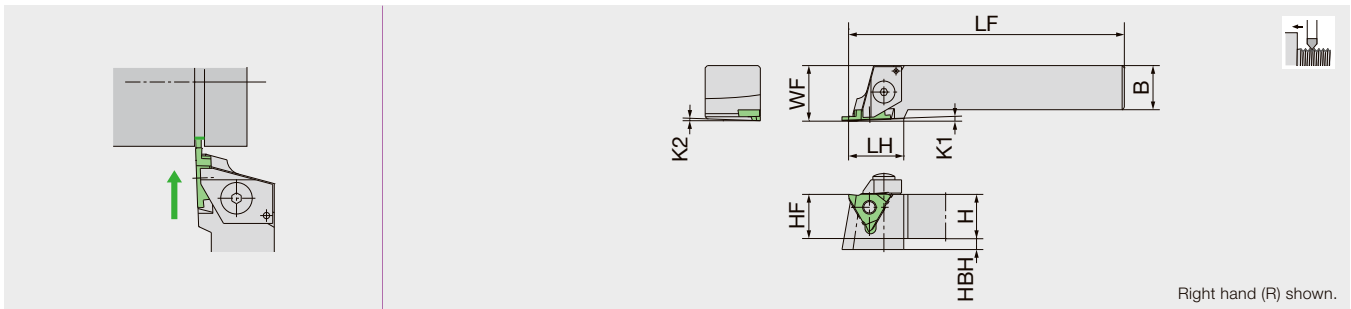

Right hand (R) shown.

Designation	CW	H	B	LF	LH	CDX	HBH	HF	K1	K2	WF	Insert
NGTBR161643-00S	1 - 5.5	16	16	100	25	3	9	16	2°	2°	20	GT..43..
NGTBR161643-20S	2 - 5.5	16	16	100	25	4.5	9	16	2°	2°	20	GT..43..
NGTBR161643-35S	3.5 - 5.5	16	16	100	25	4.5	9	16	2°	2°	20	GT..43..
NGTBR202043-00S	1 - 5.5	20	20	125	25	3	5	20	2°	2°	25	GT..43..
NGTBR202043-20S	2 - 5.5	20	20	125	25	4.5	5	20	2°	2°	25	GT..43..
NGTBR202043-35S	3.5 - 5.5	20	20	125	25	4.5	5	20	2°	2°	25	GT..43..
NGTBR252543-00S	1 - 5.5	25	25	150	25	3.5	-	25	2°	2°	30	GT..43..
NGTBR252543-20S	2 - 5.5	25	25	150	25	5.5	-	25	2°	2°	30	GT..43..
NGTBR252543-35S	3.5 - 5.5	25	25	150	25	5.5	-	25	2°	2°	30	GT..43..
NGTBR322543-20S	2 - 5.5	32	25	170	25	5.5	-	32	2°	2°	30	GT..43..
NGTBR322543-35S	3.5 - 5.5	32	25	170	25	5.5	-	32	2°	2°	30	GT..43..
NGTBL161643-00S	1 - 5.5	16	16	100	25	3	9	16	2°	2°	20	GT..43..
NGTBL161643-20S	2 - 5.5	16	16	100	25	4.5	9	16	2°	2°	20	GT..43..
NGTBL161643-35S	3.5 - 5.5	16	16	100	25	4.5	9	16	2°	2°	20	GT..43..
NGTBL202043-00S	1 - 5.5	20	20	125	25	3	5	20	2°	2°	25	GT..43..
NGTBL202043-20S	2 - 5.5	20	20	125	25	4.5	5	20	2°	2°	25	GT..43..
NGTBL202043-35S	3.5 - 5.5	20	20	125	25	4.5	5	20	2°	2°	25	GT..43..
NGTBL252543-00S	1 - 5.5	25	25	150	25	3.5	-	25	2°	2°	30	GT..43..
NGTBL252543-20S	2 - 5.5	25	25	150	25	5.5	-	25	2°	2°	30	GT..43..
NGTBL252543-35S	3.5 - 5.5	25	25	150	25	5.5	-	25	2°	2°	30	GT..43..
NGTBL322543-20S	2 - 5.5	32	25	170	25	5.5	-	32	2°	2°	30	GT..43..
NGTBL322543-35S	3.5 - 5.5	32	25	170	25	5.5	-	32	2°	2°	30	GT..43..

SPARE PARTS



Designation	Clamp	Clamp screw	Spring	Wrench (for Clamp screw)
NGTBR/L161643-**	CPR5	AOS-5*25	ASG-5	LW-2.5
NGTBR/L2**	CPR6	AOS-6*30	ASG-6	LW-3
NGTBR/L3**	CPR6	AOS-6*30	ASG-6	LW-3

NGTA

For horizontal gang style tool post

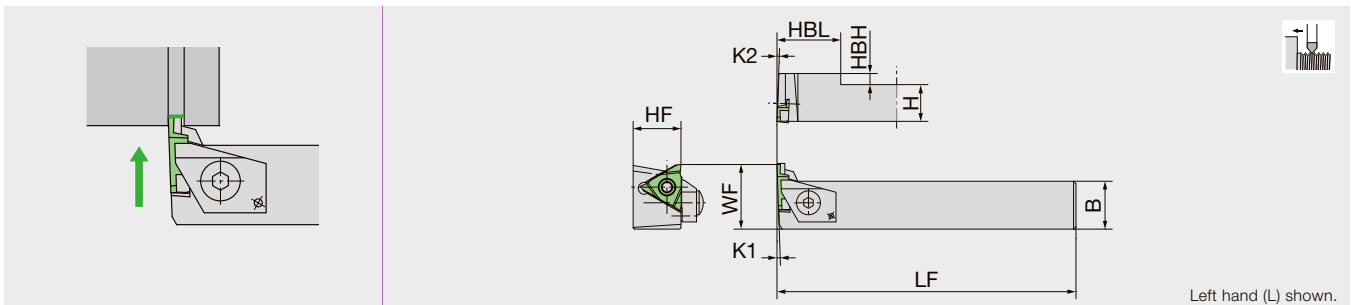

Left hand (L) shown.

Designation	CW	H	B	LF	CDX	HBH	HBL	HF	K1	K2	WF	Insert
NGTAL161643-00S	1 - 5.5	16	16	100	3	4	20	16	2°	2°	23	GT..43..
NGTAL202043-00S	1 - 5.5	20	20	125	3	-	-	20	2°	2°	27	GT..43..

NOTE: Use a right-handed (R) insert.

SPARE PARTS



Designation	Clamp	Clamp screw	Spring	Wrench (for Clamp screw)
NGTAL161643-00S	CPL5S	AOS-5*20	ASG-5	LW-2.5
NGTAL202043-00S	CPL6	AOS-6*30	ASG-6	LW-3

INSERT

GTMT43

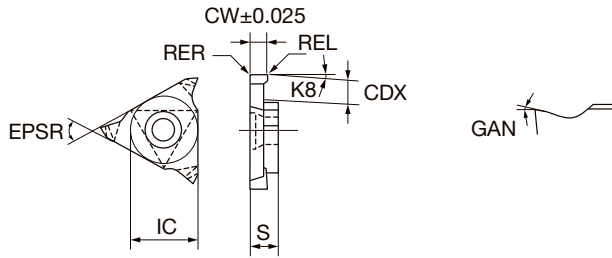

Right hand (R) shown.

P	Steel	☆	★
M	Stainless	★	☆
N	Non-ferrous	☆	★
S	Superalloys	★	☆
H	Hard materials	☆	★

★ : First choice
☆ : Second choice

Designation	HAND	Coated		CW	APMX*	CDX	IC	S	EPSR	GAN	K8	REL	RER
		DM4	QM3										
GTMT43145R	R	●	●	1.45	3	3.5	12.7	4.76	60°	11°	2°	0.2	0.2
GTMT43150R	R	●	●	1.5	3	3.5	12.7	4.76	60°	11°	2°	0.2	0.2
GTMT43175R	R	●	●	1.75	3	3.5	12.7	4.76	60°	11°	2°	0.2	0.2
GTMT43185R	R	●	●	1.85	3	3.5	12.7	4.76	60°	11°	2°	0.2	0.2
GTMT43200R	R	●	●	2	3	3.5	12.7	4.76	60°	11°	2°	0.2	0.2
GTMT43230R	R	●	●	2.3	3	3.5	12.7	4.76	60°	11°	2°	0.2	0.2
GTMT43250R	R	●	●	2.5	4.3	5.5	12.7	4.76	60°	11°	2°	0.3	0.3
GTMT43265R	R	●	●	2.65	4.3	5.5	12.7	4.76	60°	11°	2°	0.3	0.3
GTMT43280R	R	●	●	2.8	4.3	5.5	12.7	4.76	60°	11°	2°	0.3	0.3
GTMT43300R	R	●	●	3	4.3	5.5	12.7	4.76	60°	11°	2°	0.3	0.3
GTMT43330R	R	●	●	3.3	4.3	5.5	12.7	4.76	60°	11°	2°	0.3	0.3
GTMT43350R	R	●	●	3.5	4.3	5.5	12.7	4.76	60°	11°	2°	0.3	0.3
GTMT43400R	R	●	●	4	4.3	5.5	12.7	4.76	60°	11°	2°	0.4	0.4
GTMT43450R	R	●	●	4.5	4.3	5.5	12.7	4.76	60°	11°	2°	0.4	0.4
GTMT43500R	R	●	●	5	4.3	5.5	12.7	5.76	60°	11°	2°	0.4	0.4
GTMT43550R	R	●	●	5.5	4.3	5.5	12.7	5.76	60°	11°	2°	0.4	0.4
GTMT43145L	L	●	●	1.45	3	3.5	12.7	4.76	60°	11°	2°	0.2	0.2
GTMT43150L	L	●	●	1.5	3	3.5	12.7	4.76	60°	11°	2°	0.2	0.2
GTMT43175L	L	●	●	1.75	3	3.5	12.7	4.76	60°	11°	2°	0.2	0.2
GTMT43185L	L	●	●	1.85	3	3.5	12.7	4.76	60°	11°	2°	0.2	0.2
GTMT43200L	L	●	●	2	3	3.5	12.7	4.76	60°	11°	2°	0.2	0.2
GTMT43230L	L	●	●	2.3	3	3.5	12.7	4.76	60°	11°	2°	0.2	0.2
GTMT43280L	L	●	●	2.8	4.3	5.5	12.7	4.76	60°	11°	2°	0.3	0.3
GTMT43300L	L	●	●	3	4.3	5.5	12.7	4.76	60°	11°	2°	0.3	0.3
GTMT43330L	L	●	●	3.3	4.3	5.5	12.7	4.76	60°	11°	2°	0.3	0.3
GTMT43350L	L	●	●	3.5	4.3	5.5	12.7	4.76	60°	11°	2°	0.3	0.3
GTMT43400L	L	●	●	4	4.3	5.5	12.7	4.76	60°	11°	2°	0.4	0.4
GTMT43450L	L	●	●	4.5	4.3	5.5	12.7	4.76	60°	11°	2°	0.4	0.4
GTMT43500L	L	●	●	5	4.3	5.5	12.7	5.76	60°	11°	2°	0.4	0.4
GTMT43550L	L	●	●	5.5	4.3	5.5	12.7	5.76	60°	11°	2°	0.4	0.4

* Depth of cut maximum

● : Line up

Reference pages: Toolholders → 6-33 - 6-34

Grade 1
Insert 2
Ext. Toolholder 3
Int. Toolholder 4
Threading 5
Grooving 6
Shaper 7
Endmill 8
Drilling Tool 9
Technical Reference 10

INSERT

GTMA43

Full radius style

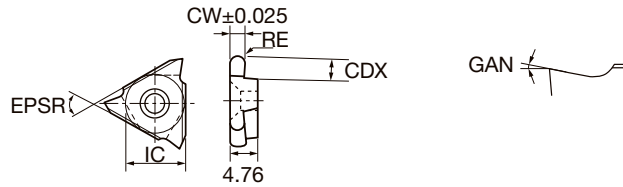

Right hand (R) shown.

P	Steel	★
M	Stainless	☆
N	Non-ferrous	
S	Superalloys	☆
H	Hard materials	☆

★ : First choice
☆ : Second choice

Designation	HAND	Coated	CW	APMX*	CDX	IC	EPSR	GAN	RE
		QM3							
GTMA43200R10R	R	●	2	3	3.5	12.7	60°	11°	1
GTMA43300R15R	R	●	3	4.5	5.5	12.7	60°	11°	1.5
GTMA43400R20R	R	●	4	4.5	5.5	12.7	60°	11°	2

* Depth of cut maximum

● : Line up

TETRAMCUT QC12-STCR/L-Y-CHP

Y-axis turning modular head for external grooving and threading, with high pressure coolant capability

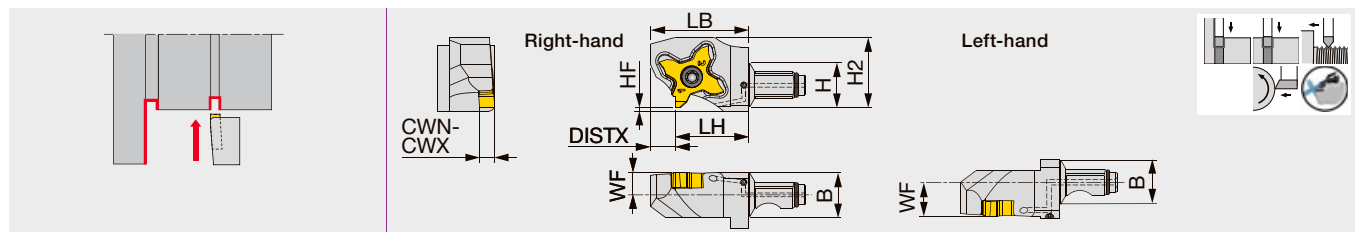

Designation	CWN	CWX	H	B	LH	HF	WF	LB	H2	DISTX	Insert	Torque*
QC12-STCR/L18-Y-CHP	0.33	3.18	12	12	19.5	0	6	26	18.6	6.5	TC*18R/L...	1.2

Torque*: Recommended clamping torque (N-m)

The right hand insert (R) is used for the right hand toolholders (R), and the left hand insert (L) is used for the left hand toolholders (L).

Through-coolant head

QC12-STCR/L-CHP

Modular head for external grooving and threading, with high pressure coolant capability

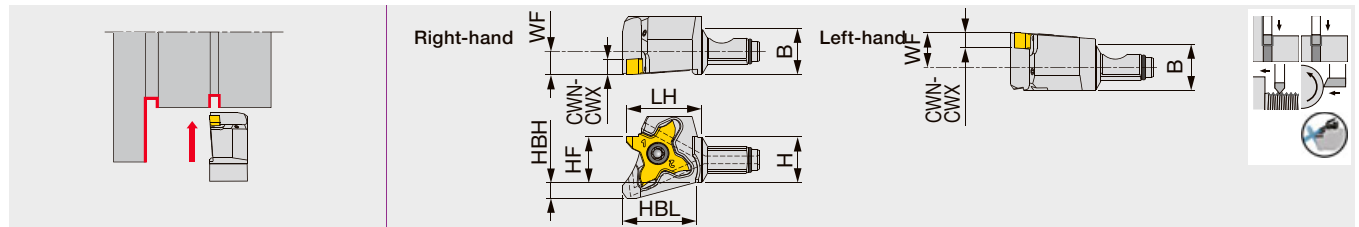

Designation	CWN	CWX	H	B	LH	HF	HBH	HBL	WF	Insert	Torque*
QC12-STCR/L18-CHP	0.33	3.18	12	12	21	12	4.2	19.3	9	TC*18R/L...	1.2

Torque*: Recommended clamping torque (N-m)

The right hand insert (R) is used for the right hand toolholders (R), and the left hand insert (L) is used for the left hand toolholders (L).

SPARE PARTS

Designation	Clamping screw	Wrench	O-ring
QC12-STCR18...	CSTC-4L100DL	T-1008/5	ORSS-0454.5X1.0NBR70
QC12-STCL18...	CSTC-4L100DR	T-1008/5	ORSS-0454.5X1.0NBR70

Reference pages : GTMA43: Toolholders → 6-33 - 6-34

QC12-STCR/L-Y-CHP, QC12-STCR/L-CHP: Inserts → 6-39 - 6-45

Shank, Accessory → 3-120, 3-121, Standard cutting conditions → 6-46, 6-47

External grooving and threading toolholder

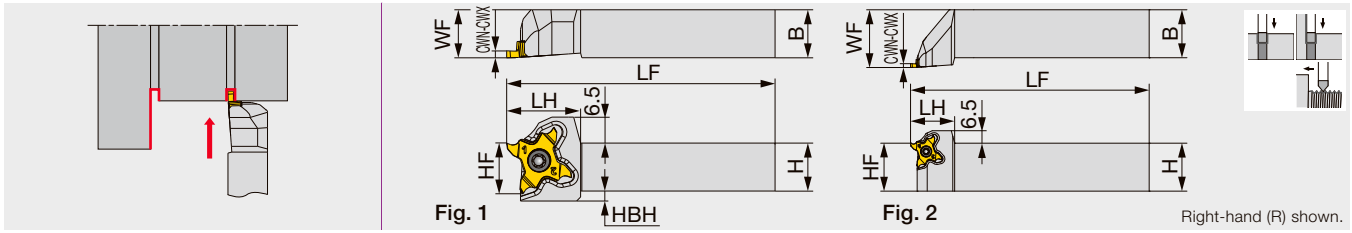

Designation	CWN	CWX	H	B	LF	LH	HF	WF	HBH	Insert	Torque*	Fig.
STCR/L1010X18	0.33	3.18	10	10	120	18.5	10	10	4.5	TC*18...	1.2	1
STCR/L1212F18	0.33	3.18	12	12	85	18.5	12	12	2.5	TC*18...	1.2	1
STCR/L1212X18	0.33	3.18	12	12	120	18.5	12	12	2.5	TC*18...	1.2	1
STCR/L1616X18	0.33	3.18	16	16	120	18.5	16	16	-	TC*18...	1.2	1
STCR/L2020H18	0.33	3.18	20	20	100	18.5	20	20	-	TC*18...	1.2	1
STCR/L2020X18	0.33	3.18	20	20	120	23	20	25	-	TC*18...	1.2	2

The right hand insert (TC*18R...) is used for the right hand toolholders (STCR...), and the left hand insert is used for the left hand toolholders

*Torque: Recommended clamping torque: N·m

JS-STCL18

External grooving and threading toolholder with round shank, for Swiss lathes

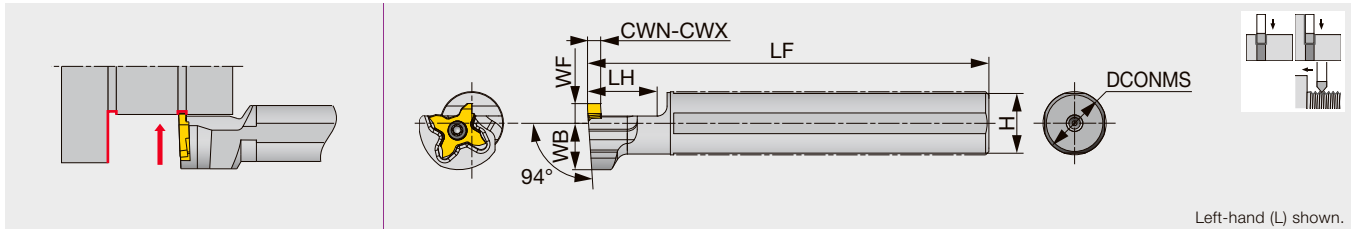

Designation	CWN	CWX	DCONMS	LF	LH	H	WB	WF	Insert	Torque*
JS14H-STCL18	0.33	3.18	14	100	20	13	14	6	TC*18R...	1.2
JS159F-STCL18	0.33	3.18	15.875	85	20	15	14	6	TC*18R...	1.2
JS16F-STCL18	0.33	3.18	16	85	20	15	14	6	TC*18R...	1.2
JS19G-STCL18	0.33	3.18	19.05	90	20	18	14	6	TC*18R...	1.2
JS19X-STCL18	0.33	3.18	19.05	120	20	18	14	6	TC*18R...	1.2
JS20G-STCL18	0.33	3.18	20	90	20	19	14	6	TC*18R...	1.2
JS20X-STCL18	0.33	3.18	20	120	20	19	14	6	TC*18R...	1.2
JS22X-STCL18	0.33	3.18	22	120	20	21	12.25	10	TC*18R...	1.2
JS25H-STCL18	0.33	3.18	25	100	20	24	12.25	10	TC*18R...	1.2
JS254X-STCL18	0.33	3.18	25.4	120	20	24	12.25	10	TC*18R...	1.2

The left hand toolholder (STCL...) is used with the right hand inserts (TC*18R...)

*Torque: Recommended clamping torque: N·m

SPARE PARTS

Designation	Clamping screw	Wrench
STCR**18, JS...STCL18	CSTC-4L100DL	T-1008/5
STCL**18	CSTC-4L100DR	T-1008/5

Threading pitch range: 0.8 - 3.0 mm

TETRAMCUT

QR12-STCL-CHP

Modular head for external grooving and threading, with high pressure coolant capability

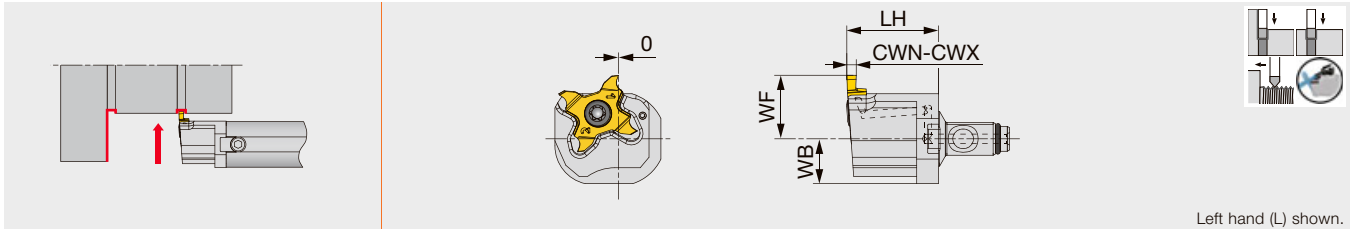

Left hand (L) shown.

Designation	CWN	CWX	LH	WF	WB	Insert	Torque*	Shank
QR12E-STCL18-CHP	0.33	3.18	19.5	11.5	7	TC*18R...	1.2	A16*-QR12
QR12G-STCL18-CHP	0.33	3.18	19.5	13.5	8	TC*18R...	1.2	A19/20*-QR12

Use left-hand toolholders (L) with right-hand inserts (R).
Torque*: Recommended clamping torque (N·m)
Assembled dimensions with shank are shown on page 9.

SPARE PARTS

Designation	Clamping screw	Wrench	O-ring
QR12*-STCL18-CHP	CSTC-4L100DL	T-1008/5	ORSS-0454.5X1.0NBR70

Reference pages : Inserts → [6-39 - 6-45](#)
Standard cutting conditions → [6-46, 6-47](#)

Selection guide for TetraMini-Cut inserts

Groove width CW (mm)	Corner rad. RE (mm)	TCL18R/L (6-44 page)	TCS18R/L (6-44 page -)	TCG18R/L (6-46 page -)		TCP18R/L (6-48 page)	TCP18R/L-F (6-49 page)
		AH7025	AH7025	AH7025	NS9530	AH725	SH7025, SH725
0.33	0.05					●	●
0.43	0.05					●	●
0.50	0.05					●	●
0.75	0.05					●	●
0.95	0.05					●	●
1.00	0.05						●
	0.1		●	●	●	●	●
1.20	0.5			●			
	0.05						●
1.25	0.1		●	●		●	●
	0.05						●
1.30	0.1		●	●	●		
	0.2		●	●	●		
1.40	0.2		●	●		●	●
	0.1		●	●			
1.45	0.2		●	●	●		
	0.05						●
1.50	0.1	●	●	●	●	●	●
	0.2	●	●	●	●		
1.58	0.79			●			
1.60	0.2		●	●			
1.70	0.2		●	●			
1.75	0.05						●
	0.1		●	●		●	●
1.85	0.2	●	●	●	●		
	0.2		●	●	●		
2.00	0.05						●
	0.1	●	●	●	●	●	●
2.25	0.2	●	●	●	●		
	1.0			●			
2.30	0.2		●	●	●		
2.39	1.2			●			
2.50	0.1		●	●		●	●
	0.2		●	●			
2.65	0.3	●	●	●	●		
	0.3		●	●	●		
2.80	0.3		●	●	●		
3.00	0.1	●	●	●	●	●	●
	0.2	●	●	●			
	0.3	●	●	●	●		
3.18	1.5			●			
	1.59						

● : Line up

Grade 1

Insert 2

Ext. Toolholder 3

Int. Toolholder 4

Threading 5

Grooving 6

Shaper 7

Endmill 8

Drilling Tool 9

Technical Reference 10

INSERT

TCL18R/L (3D chipbreaker, honed edge)

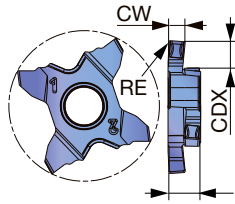

Right-hand (R) shown.

P	Steel	★
M	Stainless	★
K	Cast iron	★
N	Non-ferrous	
S	Superalloys	★
H	Hard materials	

★ : First choice



Designation	HAND	CW±0.02	RE	Coated		CDX
				AH7025		
TCL18R150-010	R	1.5	0.1	●		3.5
TCL18L150-010	L	1.5	0.1	●		3.5
TCL18R150-020	R	1.5	0.2	●		3.5
TCL18L150-020	L	1.5	0.2	●		3.5
TCL18R175-020	R	1.75	0.2	●		3.5
TCL18L175-020	L	1.75	0.2	●		3.5
TCL18R200-010	R	2	0.1	●		3.5
TCL18L200-010	L	2	0.1	●		3.5
TCL18R200-020	R	2	0.2	●		3.5
TCL18L200-020	L	2	0.2	●		3.5
TCL18R250-030	R	2.5	0.3	●		3.5
TCL18L250-030	L	2.5	0.3	●		3.5
TCL18R300-010	R	3	0.1	●		3.5
TCL18L300-010	L	3	0.1	●		3.5
TCL18R300-020	R	3	0.2	●		3.5
TCL18L300-020	L	3	0.2	●		3.5
TCL18R300-030	R	3	0.3	●		3.5
TCL18L300-030	L	3	0.3	●		3.5

Please see page 6-51 for precautions of processing.

5 pieces per package

● : Line up

TCS18R (honed edge) (3D chipbreaker, honed edge)

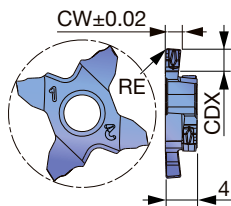

P	Steel	★
M	Stainless	★
K	Cast iron	★
N	Non-ferrous	
S	Superalloys	★
H	Hard materials	

★ : First choice

☆ : Second choice

Designation	HAND	CW±0.02	RE	Coated		CDX
				AH7025		
TCS18R100-010	R	1	0.1	●		2
TCS18L100-010	L	1	0.1	●		2
TCS18R120-010	R	1.2	0.1	●		2
TCS18L120-010	L	1.2	0.1	●		2
TCS18R125-010	R	1.25	0.1	●		2
TCS18L125-010	L	1.25	0.1	●		2

Please see page 6-51 for precautions of processing.

5 pieces per package

● : Line up

P	Steel	★
M	Stainless	★
K	Cast iron	★
N	Non-ferrous	
S	Superalloys	★
H	Hard materials	

★ : First choice
☆ : Second choice

Designation	HAND	CW±0.02	RE	Coated					CDX
				AH7025					
TCS18R125-020	R	1.25	0.2	●					2
TCS18L125-020	L	1.25	0.2	●					2
TCS18R130-020	R	1.3	0.2	●					3.5
TCS18L130-020	L	1.3	0.2	●					3.5
TCS18R140-010	R	1.4	0.1	●					3.5
TCS18L140-010	L	1.4	0.1	●					3.5
TCS18R140-020	R	1.4	0.2	●					3.5
TCS18L140-020	L	1.4	0.2	●					3.5
TCS18R145-010	R	1.45	0.1	●					3.5
TCS18L145-010	L	1.45	0.1	●					3.5
TCS18R150-010	R	1.5	0.1	●					3.5
TCS18L150-010	L	1.5	0.1	●					3.5
TCS18R150-020	R	1.5	0.2	●					3.5
TCS18L150-020	L	1.5	0.2	●					3.5
TCS18R160-020	R	1.6	0.2	●					3.5
TCS18L160-020	L	1.6	0.2	●					3.5
TCS18R170-020	R	1.7	0.2	●					3.5
TCS18L170-020	L	1.7	0.2	●					3.5
TCS18R175-010	R	1.75	0.1	●					3.5
TCS18L175-010	L	1.75	0.1	●					3.5
TCS18R175-020	R	1.75	0.2	●					3.5
TCS18L175-020	L	1.75	0.2	●					3.5
TCS18R185-020	R	1.85	0.2	●					3.5
TCS18L185-020	L	1.85	0.2	●					3.5
TCS18R195-020	R	1.95	0.2	●					3.5
TCS18L195-020	L	1.95	0.2	●					3.5
TCS18R200-010	R	2	0.1	●					3.5
TCS18L200-010	L	2	0.1	●					3.5
TCS18R200-020	R	2	0.2	●					3.5
TCS18L200-020	L	2	0.2	●					3.5
TCS18R225-020	R	2.25	0.2	●					3.5
TCS18L225-020	L	2.25	0.2	●					3.5
TCS18R230-020	R	2.3	0.2	●					3.5
TCS18L230-020	L	2.3	0.2	●					3.5
TCS18R250-010	R	2.5	0.1	●					3.5
TCS18L250-010	L	2.5	0.1	●					3.5
TCS18R250-020	R	2.5	0.2	●					3.5
TCS18L250-020	L	2.5	0.2	●					3.5
TCS18R250-030	R	2.5	0.3	●					3.5
TCS18L250-030	L	2.5	0.3	●					3.5
TCS18R265-030	R	2.65	0.3	●					3.5
TCS18L265-030	L	2.65	0.3	●					3.5
TCS18R280-030	R	2.8	0.3	●					3.5
TCS18L280-030	L	2.8	0.3	●					3.5
TCS18R300-010	R	3	0.1	●					3.5
TCS18L300-010	L	3	0.1	●					3.5
TCS18R300-020	R	3	0.2	●					3.5
TCS18L300-020	L	3	0.2	●					3.5
TCS18R300-030	R	3	0.3	●					3.5
TCS18L300-030	L	3	0.3	●					3.5

Please see page 6-51 for precautions of processing.

5 pieces per package

● : Line up

Reference pages : Toolholders → 6-40 - 6-41, Standard cutting conditions → 6-50

Grade
Insert
Ext. Toolholder
Int. Toolholder
Threading
Grooving
Shaper
Endmill
Drilling Tool
Technical Reference

INSERT

TCG18R/L (honed edge)

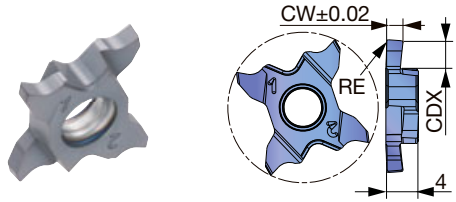

P	Steel	★		★				
M	Stainless	★						
K	Cast iron	★		★				
N	Non-ferrous							
S	Superalloys	★						
H	Hard materials							

★ : First choice
☆ : Second choice



Designation	HAND	CW±0.02	RE	Coated		Cermet		CDX
				AH7025	NS9530			
TCG18R100-010	R	1	0.1	●	●			2
TCG18L100-010	L	1	0.1	●	●			2
TCG18R120-010	R	1.2	0.1	●				2
TCG18L120-010	L	1.2	0.1	●				2
TCG18R125-010	R	1.25	0.1	●	●			2
TCG18L125-010	L	1.25	0.1	●	●			2
TCG18R125-020	R	1.25	0.2	●	●			2
TCG18L125-020	L	1.25	0.2	●	●			2
TCG18R130-020	R	1.3	0.2	●				2
TCG18L130-020	L	1.3	0.2	●				2
TCG18R140-010	R	1.4	0.1	●				3.5
TCG18L140-010	L	1.4	0.1	●				3.5
TCG18R140-020	R	1.4	0.2	●				3.5
TCG18L140-020	L	1.4	0.2	●				3.5
TCG18R145-010	R	1.45	0.1	●				3.5
TCG18L145-010	L	1.45	0.1	●				3.5
TCG18R145-020	R	1.45	0.2	●	●			3.5
TCG18L145-020	L	1.45	0.2	●	●			3.5
TCG18R150-010	R	1.5	0.1	●	●			3.5
TCG18L150-010	L	1.5	0.1	●	●			3.5
TCG18R150-020	R	1.5	0.2	●	●			3.5
TCG18L150-020	L	1.5	0.2	●	●			3.5
TCG18R160-020	R	1.6	0.2	●				3.5
TCG18L160-020	L	1.6	0.2	●				3.5
TCG18R170-020	R	1.7	0.2	●				3.5
TCG18L170-020	L	1.7	0.2	●				3.5
TCG18R175-010	R	1.75	0.1	●				3.5
TCG18L175-010	L	1.75	0.1	●				3.5
TCG18R175-020	R	1.75	0.2	●	●			3.5
TCG18L175-020	L	1.75	0.2	●	●			3.5
TCG18R185-020	R	1.85	0.2	●	●			3.5
TCG18L185-020	L	1.85	0.2	●	●			3.5
TCG18R195-020	R	1.95	0.2	●				3.5
TCG18L195-020	L	1.95	0.2	●				3.5
TCG18R200-010	R	2	0.1	●	●			3.5
TCG18L200-010	L	2	0.1	●	●			3.5
TCG18R200-020	R	2	0.2	●	●			3.5
TCG18L200-020	L	2	0.2	●	●			3.5
TCG18R225-020	R	2.25	0.2	●				3.5
TCG18L225-020	L	2.25	0.2	●				3.5
TCG18R230-020	R	2.3	0.2	●	●			3.5
TCG18L230-020	L	2.3	0.2	●	●			3.5
TCG18R250-010	R	2.5	0.1	●				3.5
TCG18L250-010	L	2.5	0.1	●				3.5

Please see page 6-51 for precautions of processing.

5 pieces per package

● : Line up

Reference pages : Toolholders → 6-40 - 6-41, Standard cutting conditions → 6-50

P	Steel	★		★																
M	Stainless	★																		
K	Cast iron	★		★																
N	Non-ferrous																			
S	Superalloys	★																		
H	Hard materials																			

★ : First choice
☆ : Second choice

Designation	HAND	CW±0.02	RE	Coated		Cermet									CDX					
				AH7025		NS9530														
TCG18R250-020	R	2.5	0.2	●																3.5
TCG18L250-020	L	2.5	0.2	●																3.5
TCG18R250-030	R	2.5	0.3	●		●														3.5
TCG18L250-030	L	2.5	0.3	●		●														3.5
TCG18R265-030	R	2.65	0.3	●		●														3.5
TCG18L265-030	L	2.65	0.3	●		●														3.5
TCG18R280-030	R	2.8	0.3	●		●														3.5
TCG18L280-030	L	2.8	0.3	●		●														3.5
TCG18R300-010	R	3	0.1	●		●														3.5
TCG18L300-010	L	3	0.1	●		●														3.5
TCG18R300-020	R	3	0.2	●																3.5
TCG18L300-020	L	3	0.2	●																3.5
TCG18R300-030	R	3	0.3	●		●														3.5
TCG18L300-030	L	3	0.3	●		●														3.5

Please see page 6-51 for precautions of processing.

5 pieces per package

● : Line up

TCG18R/L (Full R, honed edge)

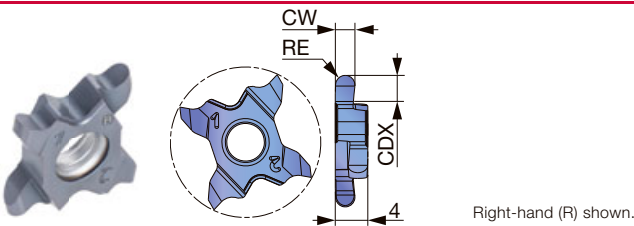

P	Steel	⊖																		
M	Stainless	⊖																		
K	Cast iron	⊖																		
N	Non-ferrous																			
S	Superalloys	⊖																		
H	Hard materials																			

★ : First choice
☆ : Second choice

Designation	HAND	CW±0.02	RE	Coated									CDX							
				AH7025																
TCG18R100-050	R	1	0.5	●																2
TCG18L100-050	L	1	0.5	●																2
TCG18R158-079	R	1.58	0.79	●																3.5
TCG18L158-079	L	1.58	0.79	●																3.5
TCG18R200-100	R	2	1	●																3.5
TCG18L200-100	L	2	1	●																3.5
TCG18R239-120	R	2.39	1.2	●																3.5
TCG18L239-120	L	2.39	1.2	●																3.5
TCG18R300-150	R	3	1.5	●																3.5
TCG18L300-150	L	3	1.5	●																3.5
TCG18R318-159	R	3.18	1.59	●																3.5
TCG18L318-159	L	3.18	1.59	●																3.5

Please see page 6-51 for precautions of processing.

5 pieces per package

● : Line up

Reference pages : Toolholders → 6-40 - 6-41, Standard cutting conditions → 6-50

Grade 1
Insert 2
Ext. Toolholder 3
Int. Toolholder 4
Threading 5
Grooving 6
Shaper 7
Endmill 8
Drilling Tool 9
Technical Reference 10

INSERT

TCP18R/L (lightly honed edge)

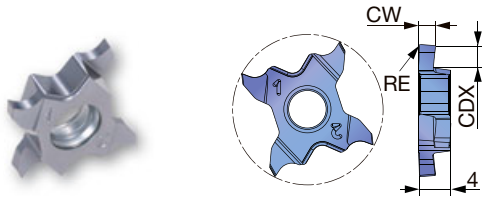

P	Steel	★	★
M	Stainless	★	★
K	Cast iron	★	★
N	Non-ferrous		
S	Superalloys	★	★
H	Hard materials		

★ : First choice
☆ : Second choice



Designation	HAND	CW±0.02	RE	Coated		CDX
				AH725	SH7025	
TCP18R033-005	R	0.33	0.05	●		0.8
TCP18L033-005	L	0.33	0.05	●		0.8
TCP18R043-005	R	0.43	0.05	●		1.2
TCP18L043-005	L	0.43	0.05	●		1.2
TCP18R050-005	R	0.50	0.05	●		1.2
TCP18L050-005	L	0.50	0.05	●		1.2
TCP18R075-005	R	0.75	0.05	●		2
TCP18L075-005	L	0.75	0.05	●		2
TCP18R095-005	R	0.95	0.05	●		2
TCP18L095-005	L	0.95	0.05	●		2
TCP18R100-010	R	1	0.1	●		2
TCP18L100-010	L	1	0.1	●		2
TCP18R120-010	R	1.2	0.1	●		2
TCP18L120-010	L	1.2	0.1	●		2
TCP18R125-010	R	1.25	0.1	●		2
TCP18L125-010	L	1.25	0.1	●		2
TCP18R140-010-35	R	1.4	0.1	●		3.5
TCP18L140-010-35	L	1.4	0.1	●		3.5
TCP18R145-010	R	1.45	0.1	●		2
TCP18L145-010	L	1.45	0.1	●		2
TCP18R145-010-35	R	1.45	0.1	●		3.5
TCP18L145-010-35	L	1.45	0.1	●		3.5
TCP18R150-010	R	1.5	0.1	●		2
TCP18L150-010	L	1.5	0.1	●		2
TCP18R150-010-35	R	1.5	0.1	●		3.5
TCP18L150-010-35	L	1.5	0.1	●		3.5
TCP18R175-010	R	1.75	0.1	●		2
TCP18L175-010	L	1.75	0.1	●		2
TCP18R175-010-35	R	1.75	0.1	●		3.5
TCP18L175-010-35	L	1.75	0.1	●		3.5
TCP18R200-010	R	2	0.1	●		2.5
TCP18L200-010	L	2	0.1	●		2.5
TCP18R200-010-35	R	2	0.1	●		3.5
TCP18L200-010-35	L	2	0.1	●		3.5
TCP18R250-010	R	2.5	0.1	●		2.5
TCP18L250-010	L	2.5	0.1	●		2.5
TCP18R250-010-35	R	2.5	0.1	●		3.5
TCP18L250-010-35	L	2.5	0.1	●		3.5
TCP18R300-010	R	3	0.1	●		2.5
TCP18L300-010	L	3	0.1	●		2.5
TCP18R300-010-35	R	3	0.1	●		3.5
TCP18L300-010-35	L	3	0.1	●		3.5

Please see page 6-51 for precautions of processing.

5 pieces per package

● : Line up

Reference pages : Toolholders → 6-40 - 6-41, Standard cutting conditions → 6-50

TCP18R/L-F (sharp edge)

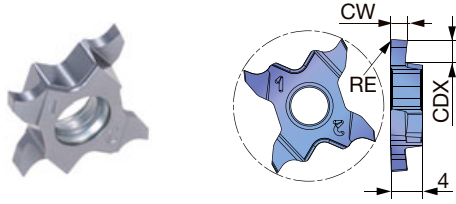

P	Steel	★	★
M	Stainless	★	★
K	Cast iron	★	★
N	Non-ferrous		
S	Superalloys	★	★
H	Hard materials		

★ : First choice
☆ : Second choice

Designation	HAND	CW±0.02	RE	Coated		CDX
				SH725	SH7025	
TCP18R033F-005	R	0.33	0.05	●	●	0.8
TCP18L033F-005	L	0.33	0.05	●	●	0.8
TCP18R043F-005	R	0.43	0.05	●	●	1.2
TCP18L043F-005	L	0.43	0.05	●	●	1.2
TCP18R050F-005	R	0.5	0.05	●	●	1.2
TCP18L050F-005	L	0.5	0.05	●	●	1.2
TCP18R075F-005	R	0.75	0.05	●	●	2
TCP18L075F-005	L	0.75	0.05	●	●	2
TCP18R095F-005	R	0.95	0.05	●	●	2
TCP18L095F-005	L	0.95	0.05	●	●	2
TCP18R100F-005	R	1	0.05	●	●	2
TCP18R100F-010	R	1	0.1	●	●	2
TCP18L100F-010	L	1	0.1	●	●	2
TCP18R120F-005	R	1.2	0.05	●	●	2
TCP18R120F-010	R	1.2	0.1	●	●	2
TCP18L120F-010	L	1.2	0.1	●	●	2
TCP18R125F-005	R	1.25	0.05	●	●	2
TCP18R125F-010	R	1.25	0.1	●	●	2
TCP18L125F-010	L	1.25	0.1	●	●	2
TCP18R140F-010-35	R	1.4	0.1	●	●	3.5
TCP18R145F-005-35	R	1.45	0.05	●	●	3.5
TCP18R145F-010	R	1.45	0.1	●		2
TCP18L145F-010	L	1.45	0.1	●		2
TCP18R145F-010-35	R	1.45	0.1	●	●	3.5
TCP18L145F-010-35	L	1.45	0.1	●	●	3.5
TCP18R150F-005-35	R	1.5	0.05	●	●	3.5
TCP18R150F-010	R	1.5	0.1	●		2
TCP18L150F-010	L	1.5	0.1	●		2
TCP18R150F-010-35	R	1.5	0.1	●	●	3.5
TCP18L150F-010-35	L	1.5	0.1	●	●	3.5
TCP18R175F-005-35	R	1.75	0.05	●	●	3.5
TCP18R175F-010	R	1.75	0.1	●		2
TCP18L175F-010	L	1.75	0.1	●		2
TCP18R175F-010-35	R	1.75	0.1	●	●	3.5
TCP18L175F-010-35	L	1.75	0.1	●	●	3.5
TCP18R200F-005-35	R	2	0.05	●	●	3.5
TCP18R200F-010	R	2	0.1	●		2.5
TCP18L200F-010	L	2	0.1	●		2.5
TCP18R200F-010-35	R	2	0.1	●	●	3.5
TCP18L200F-010-35	L	2	0.1	●	●	3.5
TCP18R250F-010	R	2.5	0.1	●		2.5
TCP18L250F-010	L	2.5	0.1	●		2.5
TCP18R250F-010-35	R	2.5	0.1	●	●	3.5
TCP18L250F-010-35	L	2.5	0.1	●	●	3.5
TCP18R300F-010	R	3	0.1	●		2.5
TCP18L300F-010	L	3	0.1	●		2.5
TCP18R300F-010-35	R	3	0.1	●	●	3.5
TCP18L300F-010-35	L	3	0.1	●	●	3.5

Please see page 6-51 for precautions of processing.

5 pieces per package

● : Line up

Reference pages : Toolholders → 6-40 - 6-41, Standard cutting conditions → 6-50

Grade 1
Insert 2
Ext. Toolholder 3
Int. Toolholder 4
Threading 5
Grooving 6
Shaper 7
Endmill 8
Drilling Tool 9
Technical Reference 10

STANDARD CUTTING CONDITIONS

TCS18R (3D chipbreaker) , TCG18R/L (honed edge)

ISO	Workpiece materials	Grades	Cutting speed Vc (m/min)	Feed: f (mm/rev)	
				TCG	TCS
P	Low carbon steel S15C, S20C, etc. C15, C20, etc.	AH7025	80 - 180	0.03 - 0.12	0.03 - 0.15
	Carbon steels, Alloy steel S55C, SCM440, etc. C55, 42CrMoS4, etc.	AH7025	80 - 180	0.03 - 0.12	0.03 - 0.15
	Prehardened steel NAK80, PX5, etc.	AH7025	80 - 180	0.03 - 0.12	0.03 - 0.15
M	Stainless steel SUS304, SUS316, etc. X5CrNi18-9, X5CrNiMo17-12-3, etc.	AH7025	50 - 120	0.03 - 0.12	0.03 - 0.15
K	Grey cast iron FC250, FC300, etc. 250, 300, etc.	AH7025	50 - 180	0.03 - 0.12	0.03 - 0.15
	Ductile cast iron FCD400, FCD600, etc. 400-15, 600-3, etc.	AH7025	50 - 180	0.03 - 0.12	0.03 - 0.15
S	Titanium alloys Ti-6Al-4V, etc.	AH7025	30 - 80	0.03 - 0.12	0.03 - 0.15
	Superalloys Inconel718, etc.	AH7025	20 - 60	0.03 - 0.12	0.03 - 0.15



External



Internal



Face



Parting

TCL18R (3D chipbreaker), TCG18R/L (Full R, honed edge)

ISO	Workpiece materials	Grades	Cutting speed Vc (m/min)	Feed: f (mm/rev)	
				TCL18	TCG18
P	Low carbon steel S15C, S20C, etc. C15, C20, etc.	AH7025	80 - 180	0.03 - 0.12	0.04 - 0.14
	Carbon steels, Alloy steel S55C, SCM440, etc. C55, 42CrMoS4, etc.	AH7025	80 - 180	0.03 - 0.12	0.04 - 0.14
	Prehardened steel NAK80, PX5, etc.	AH7025	80 - 180	0.03 - 0.12	0.04 - 0.14
M	Stainless steel SUS304, SUS316, etc. X5CrNi18-9, X5CrNiMo17-12-3, etc.	AH7025	50 - 120	0.03 - 0.12	0.04 - 0.14
K	Grey cast iron FC250, FC300, etc. 250, 300, etc.	AH7025	50 - 180	0.03 - 0.12	0.04 - 0.14
	Ductile cast iron FCD400, FCD600, etc. 400-15, 600-3, etc.	AH7025	50 - 180	0.03 - 0.12	0.04 - 0.14
S	Titanium alloys Ti-6Al-4V, etc.	AH7025	30 - 80	0.03 - 0.12	0.04 - 0.14
	Superalloys Inconel718, etc.	AH7025	20 - 60	0.03 - 0.12	0.04 - 0.14

TCP18R/L (lightly honed edge) / TCP18R/L-F (sharp edge)

ISO	Workpiece materials	Priority	Grades	Cutting speed Vc (m/min)	Feed f (mm/rev)
P	Low carbon steel S15C, S20C, etc. C15, C20, etc.	First choice	SH725	80 - 180	0.03 - 0.1
		Toughness	AH725	80 - 180	0.03 - 0.1
	Carbon steels, Alloy steel S55C, SCM440, etc. C55, 42CrMoS4, etc.	First choice	SH725	80 - 180	0.03 - 0.1
		Toughness	AH725	80 - 180	0.03 - 0.1
	Prehardened steel NAK80, PX5, etc.	First choice	SH725	80 - 180	0.03 - 0.1
		Toughness	AH725	80 - 180	0.03 - 0.1
M	Stainless steel SUS304, SUS316, etc. X5CrNi18-9, X5CrNiMo17-12-3, etc.	First choice	SH725	50 - 120	0.03 - 0.1
		Toughness	AH725	50 - 120	0.03 - 0.1
K	Grey cast iron FC250, FC300, etc. 250, 300, etc.	First choice	AH725	50 - 180	0.03 - 0.1
		Sharpness	SH725	50 - 180	0.03 - 0.1
	Ductile cast iron FCD400, FCD600, etc. 400-15, 600-3, etc.	First choice	AH725	50 - 180	0.03 - 0.1
		Sharpness	SH725	50 - 180	0.03 - 0.1
S	Titanium alloys Ti-6Al-4V, etc.	First choice	SH725	30 - 80	0.03 - 0.1
		Toughness	AH725	30 - 80	0.03 - 0.1
	Superalloys Inconel718, etc.	First choice	SH725	20 - 60	0.03 - 0.1
		Toughness	AH725	20 - 60	0.03 - 0.1

PRECAUTIONS OF PROCESSING

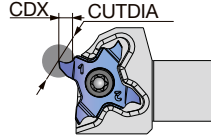
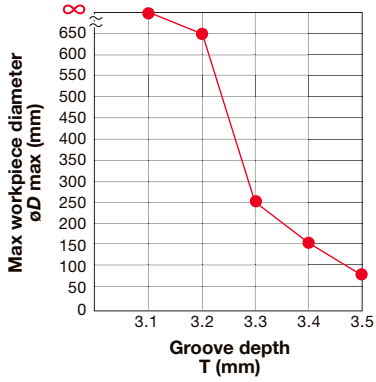
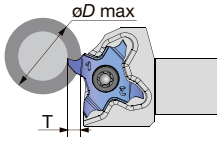

Max workpiece diameter CUTDIA (mm)
7

*Groove depth and max workpiece diameter (øDmax)

Maximum workpiece diameter is limited relative to depth of cut in order to avoid collision between insert and workpiece.

Grade

1

Insert

2

Ext. Toolholder

3

Int. Toolholder

4

Threading

5

Grooving

6

Shaper

7

Endmill

8

Drilling Tool

9

Technical Reference

10

External grooving toolholder

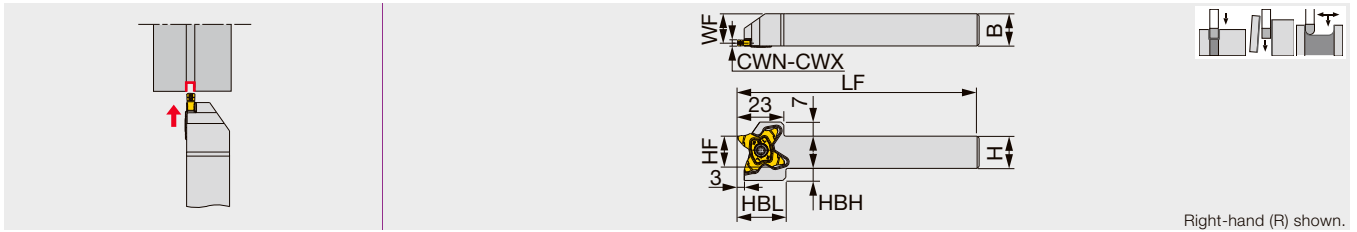

Designation	CWN	CWX	H	B	LF	HF	WF	HBH	HBL	Insert	Torque*
STCR/L1010-27	0.5	3.18	10	10	120	10	8.5	9.5	24	TC*27...	2.5
STCR/L1212-27	0.5	3.18	12	12	120	12	10.5	8	24	TC*27...	2.5
STCR/L1616-27	0.5	3.18	16	16	120	16	14.5	6	24	TC*27...	2.5
STCR/L2020-27	0.5	3.18	20	20	120	20	18.5	2	24	TC*27...	2.5

Torque*: Recommended clamping torque (N-m)

STCR/L1212-27-CHP

Direct connection

Grooving and parting-off toolholder. High pressure coolant capability.

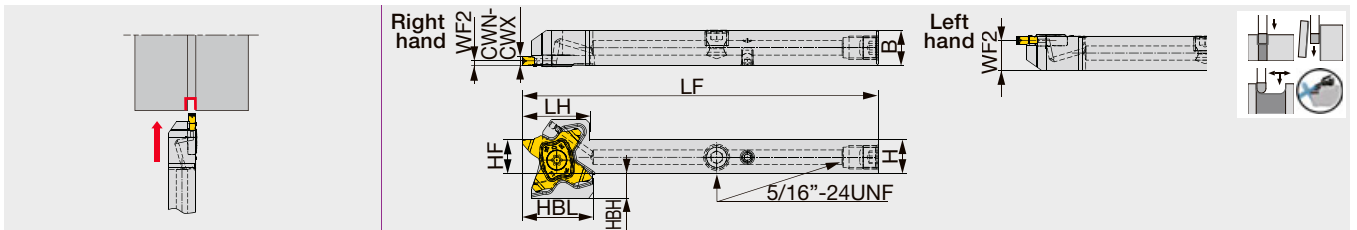

Designation	CWN	CWX	H	B	LF	LH	HF	WF2 ⁽¹⁾	HBH	HBL	Insert	Torque*
STCR/L1212-27-CHP	0.5	3.18	12	12	120	23	12	1.5/10.5	8	24	TC*27...	2.5

(1) The above WF value is valid when an insert width of CW=3 is mounted.

*Torque: Recommended torque (N-m) for clamping

Make sure to avoid tool interferences when used on Swiss machines

STCR/L2020-27-CHP

Tube connection

External grooving and parting-off toolholder with high pressure coolant supply

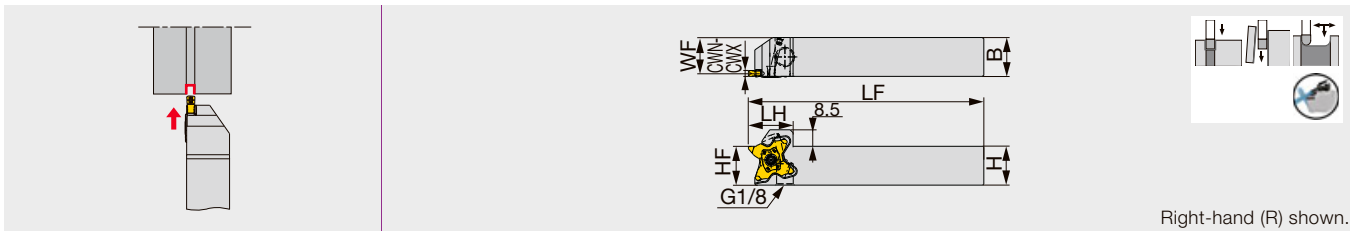

Designation	CWN	CWX	H	B	LF	LH	HF	WF	Insert	Torque*
STCR/L2020-27-CHP	0.5	3.18	20	20	120	23	20	18.5	TC*27...	2.5

Torque*: Recommended clamping torque (N-m)

SPARE PARTS

Designation	Screw	Wrench
STCR****-27, STCR...-27-CHP	SR16-212-01397L	T-2010/5
STCL****-27, STCL...-27-CHP	SR16-212-01397	T-2010/5

Reference pages : STCR/L-27, STCR/L1212-27-CHP, STCR/L2020-27-CHP:
 Inserts → 6-49 - 6-53, Standard cutting conditions → 6-53

INSERT - FOR GROOVING AND PARTING OFF

TCL27

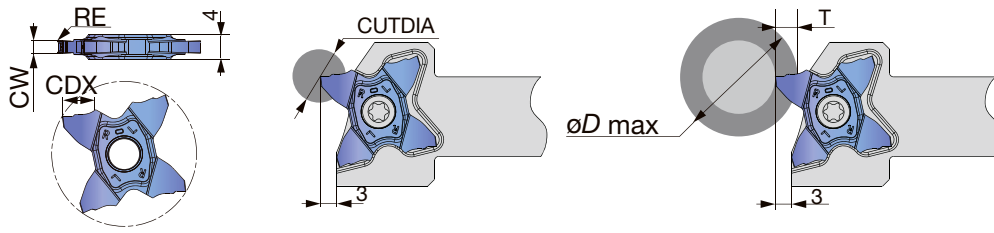

P	Steel	★	
M	Stainless	★	
K	Cast iron	★	
N	Non-ferrous		
S	Superalloys	★	
H	Hard materials		

★ : First choice
☆ : Second choice

Designation	CW±0.02	RE	Coated		CDX	CUTDIA	Relation of groove depth (T) and Max. diameter (øD max)									
			AH725				T ≤ 3	T ≤ 3.5	T ≤ 4	T ≤ 4.5	T ≤ 5	T ≤ 5.5	T ≤ 5.7	T ≤ 6	T ≤ 6.2	T ≤ 6.4
							●	☆								
TCL27-150-015	1.5	0.15	●	☆	5.7	11.4	∞	600	280	180	130	50	35	-	-	-
TCL27-200-020	2	0.2	●	☆	6.4	12.8	∞	600	280	180	130	105	85	60	50	30
TCL27-250-020	2.5	0.2	●	☆	6.4	12.8	∞	600	280	180	130	105	85	60	50	30
TCL27-300-020	3	0.2	●	☆	6.4	12.8	∞	600	280	180	135	105	95	85	78	55

5 pieces per package

● : Line up

HOW TO INDEX INSERTS

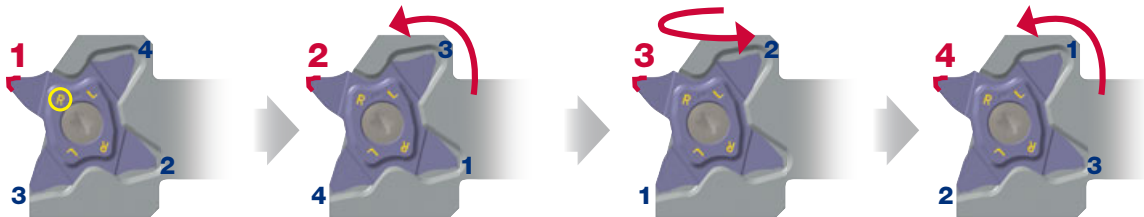

1. Right-hand edge (R) is used for the right-hand toolholders.

2. Rotate the insert

3. Flip over the insert

4. Rotate the insert

INSERT - FOR GROOVING AND PARTING OFF

TCS27

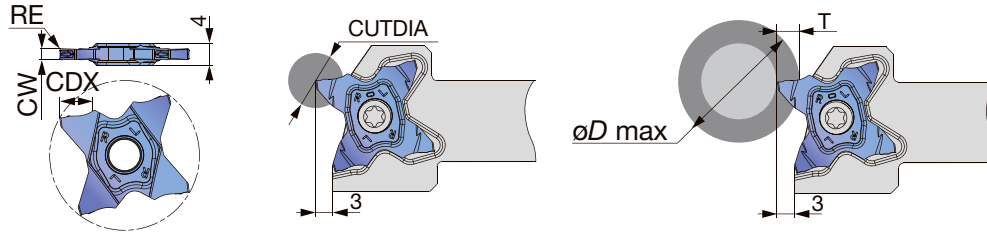

P	Steel	★	
M	Stainless	★	
K	Cast iron	★	
N	Non-ferrous		
S	Superalloys	★	
H	Hard materials		

★ : First choice
☆ : Second choice



Designation	CW±0.02	RE	Coated		CDX	CUTDIA	Relation of groove depth (T) and Max. diameter (øD max)												
			AH725				T≤1	T≤2	T≤3	T≤3.5	T≤4	T≤4.5	T≤5	T≤5.5	T≤5.7	T≤6	T≤6.2	T≤6.4	
TCS27-050-000	0.5	0	●		1	2	∞	-	-	-	-	-	-	-	-	-	-	-	-
TCS27-050-004	0.5	0.04	●		2.5	5	∞	∞	-	-	-	-	-	-	-	-	-	-	-
TCS27-075-010	0.75	0.1	●		2.5	5	∞	∞	-	-	-	-	-	-	-	-	-	-	-
TCS27-080-000	0.8	0	●		1.6	3.2	∞	-	-	-	-	-	-	-	-	-	-	-	-
TCS27-100-006	1	0.06	●		3.5	7	∞	∞	∞	600	-	-	-	-	-	-	-	-	-
TCS27-100-010	1	0.1	●		3.5	7	∞	∞	∞	600	-	-	-	-	-	-	-	-	-
TCS27-104-000	1.04	0	●		2	4	∞	∞	-	-	-	-	-	-	-	-	-	-	-
TCS27-120-000	1.2	0	●		2	4	∞	∞	-	-	-	-	-	-	-	-	-	-	-
TCS27-125-010	1.25	0.1	●		3.5	7	∞	∞	∞	600	-	-	-	-	-	-	-	-	-
TCS27-125-020	1.25	0.2	●		3.5	7	∞	∞	∞	600	-	-	-	-	-	-	-	-	-
TCS27-140-000	1.4	0	●		2	4	∞	∞	-	-	-	-	-	-	-	-	-	-	-
TCS27-147-000	1.47	0	●		2.5	5	∞	∞	-	-	-	-	-	-	-	-	-	-	-
TCS27-150-010	1.5	0.1	●		5.7	11.4	∞	∞	∞	600	280	180	130	50	35	-	-	-	-
TCS27-150-020	1.5	0.2	●		5.7	11.4	∞	∞	∞	600	280	180	130	50	35	-	-	-	-
TCS27-157-015	1.57	0.15	●		3	6	∞	∞	∞	-	-	-	-	-	-	-	-	-	-
TCS27-170-010	1.7	0.1	●		3	6	∞	∞	∞	-	-	-	-	-	-	-	-	-	-
TCS27-175-010	1.75	0.1	●		3	6	∞	∞	∞	-	-	-	-	-	-	-	-	-	-
TCS27-175-020	1.75	0.2	●		3	6	∞	∞	∞	-	-	-	-	-	-	-	-	-	-
TCS27-178-018	1.78	0.18	●		3	6	∞	∞	∞	-	-	-	-	-	-	-	-	-	-
TCS27-185-020	1.85	0.2	●		3	6	∞	∞	∞	-	-	-	-	-	-	-	-	-	-
TCS27-196-015	1.96	0.15	●		3	6	∞	∞	∞	-	-	-	-	-	-	-	-	-	-
TCS27-200-010	2	0.1	●		6.4	12.8	∞	∞	∞	600	280	180	130	105	85	60	50	30	
TCS27-200-020	2	0.2	●		6.4	12.8	∞	∞	∞	600	280	180	130	105	85	60	50	30	
TCS27-222-015	2.22	0.15	●		3.5	7	∞	∞	∞	600	-	-	-	-	-	-	-	-	-
TCS27-230-020	2.3	0.2	●		3.5	7	∞	∞	∞	600	-	-	-	-	-	-	-	-	-
TCS27-239-015	2.39	0.15	●		5.7	11.4	∞	∞	∞	600	280	180	130	50	35	-	-	-	-
TCS27-247-020	2.47	0.2	●		5.7	11.4	∞	∞	∞	600	280	180	130	50	35	-	-	-	-
TCS27-250-010	2.5	0.1	●		5.7	11.4	∞	∞	∞	600	280	180	130	50	35	-	-	-	-
TCS27-250-030	2.5	0.3	●		5.7	11.4	∞	∞	∞	600	280	180	130	50	35	-	-	-	-
TCS27-270-010	2.7	0.1	●		6.2	12.4	∞	∞	∞	600	280	180	135	105	95	85	78	-	-
TCS27-287-020	2.87	0.2	●		6.2	12.4	∞	∞	∞	600	280	180	135	105	95	85	78	-	-
TCS27-300-000	3	0	●		6.4	12.8	∞	∞	∞	600	280	180	135	105	95	85	78	55	
TCS27-300-020	3	0.2	●		6.4	12.8	∞	∞	∞	600	280	180	135	105	95	85	78	55	
TCS27-300-030	3	0.3	●		6.4	12.8	∞	∞	∞	600	280	180	135	105	95	85	78	55	
TCS27-300-040	3	0.4	●		6.4	12.8	∞	∞	∞	600	280	180	135	105	95	85	78	55	
TCS27-315-015	3.15	0.15	●		6.4	12.8	∞	∞	∞	600	280	180	135	105	95	85	78	68	
TCS27-318-020	3.18	0.2	●		6.4	12.8	∞	∞	∞	600	280	180	135	105	95	85	78	68	

5 pieces per package
● : Line up

Reference pages : Toolholders → 6-48, Standard cutting conditions → 6-53

INSERT- FOR PARTING OFF

TCS27-R/L

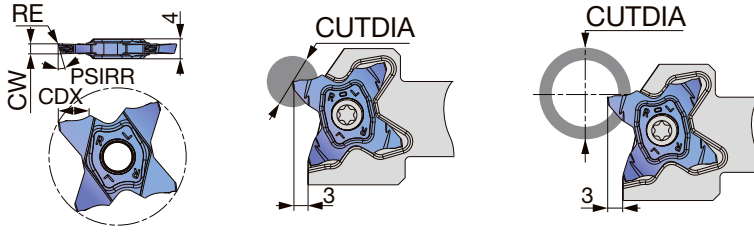

P	Steel	★		
M	Stainless	★		
K	Cast iron	★		
N	Non-ferrous			
S	Superalloys	★		
H	Hard materials			

★ : First choice
☆ : Second choice

Designation	HAND	CW±0.02	RE	Coated		CDX	PSIRL	PSIRR	Max. parting off dia. CUTDIA	
				AH725					Solid bar	Tube
TCS27-100-15R	R	1	0.06	●		3.5	0°	15°	7	600
TCS27-100-15L	L	1	0.06	●		3.5	15°	0°	7	600
TCS27-150-6R	R	1.5	0.06	●		5.7	0°	6°	11.4	35
TCS27-150-6L	L	1.5	0.06	●		5.7	6°	0°	11.4	35
TCS27-150-15R	R	1.5	0.06	●		5.7	0°	15°	11.4	35
TCS27-150-15L	L	1.5	0.06	●		5.7	15°	0°	11.4	35
TCS27-200-6R	R	2	0.1	●		6.4	0°	6°	12.8	30
TCS27-200-6L	L	2	0.1	●		6.4	6°	0°	12.8	30
TCS27-200-15R	R	2	0.1	●		6.4	0°	15°	12.8	30
TCS27-200-15L	L	2	0.1	●		6.4	15°	0°	12.8	30

5 pieces per package

● : Line up

INSERT- FOR GROOVING AND PROFILING

TCS27 (Full R)

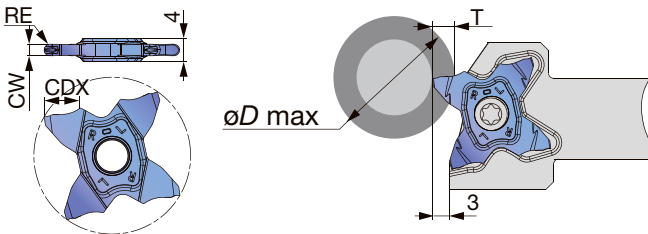

P	Steel	★		
M	Stainless	★		
K	Cast iron	★		
N	Non-ferrous			
S	Superalloys	★		
H	Hard materials			

★ : First choice
☆ : Second choice

Designation	CW±0.02	RE	Coated		CDX	Relation of groove depth (T) and Max. diameter (øD max)										
			AH725			T ≤ 3	T ≤ 3.5	T ≤ 4	T ≤ 4.5	T ≤ 5	T ≤ 5.5	T ≤ 5.7	T ≤ 6	T ≤ 6.2	T ≤ 6.4	
TCS27-157-079	1.57	0.79	●		3	∞	-	-	-	-	-	-	-	-	-	-
TCS27-200-100	2	1	●		3	∞	-	-	-	-	-	-	-	-	-	-
TCS27-239-120	2.39	1.2	●		5.7	∞	600	280	180	130	50	35	-	-	-	-
TCS27-300-150	3	1.5	●		6.4	∞	600	280	180	135	105	95	85	78	55	-

5 pieces per package

● : Line up

Reference pages : Toolholders → 6-48, Standard cutting conditions → 6-53

Grade 1
Insert 2
Ext. Toolholder 3
Int. Toolholder 4
Threading 5
Grooving 6
Shaper 7
Endmill 8
Drilling Tool 9
Technical Reference 10

INSERT- FOR GROOVING AND PARTING OFF

TCM27

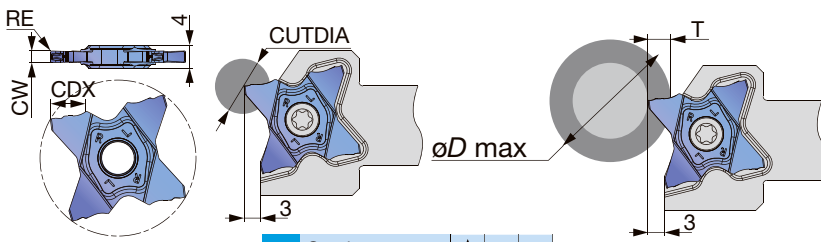

P	Steel	★		
M	Stainless	★		
K	Cast iron	★		
N	Non-ferrous	★		
S	Superalloys	★		
H	Hard materials	★		

★ : First choice
☆ : Second choice



Designation	CW±0.02	RE	Coated		CDX	CUTDIA	Relation of groove depth (T) and Max. diameter (øD max)									
			AH725				T ≤ 3	T ≤ 3.5	T ≤ 4	T ≤ 4.5	T ≤ 5	T ≤ 5.5	T ≤ 5.7	T ≤ 6	T ≤ 6.2	T ≤ 6.4
TCM27-150-010	1.5	0.1	●		5.7	11.4	∞	600	280	180	130	50	35	-	-	-
TCM27-150-020	1.5	0.2	●		5.7	11.4	∞	600	280	180	130	50	35	-	-	-
TCM27-157-015	1.57	0.15	●		3	6	∞	-	-	-	-	-	-	-	-	-
TCM27-170-010	1.7	0.1	●		3	6	∞	-	-	-	-	-	-	-	-	-
TCM27-175-010	1.75	0.1	●		3	6	∞	-	-	-	-	-	-	-	-	-
TCM27-175-020	1.75	0.2	●		3	6	∞	-	-	-	-	-	-	-	-	-
TCM27-178-018	1.78	0.18	●		3	6	∞	-	-	-	-	-	-	-	-	-
TCM27-185-020	1.85	0.2	●		3	6	∞	-	-	-	-	-	-	-	-	-
TCM27-196-015	1.96	0.15	●		3	6	∞	-	-	-	-	-	-	-	-	-
TCM27-200-010	2	0.1	●		6.4	12.8	∞	600	280	180	130	105	85	60	50	30
TCM27-200-020	2	0.2	●		6.4	12.8	∞	600	280	180	130	105	85	60	50	30
TCM27-222-015	2.22	0.15	●		3.5	7	∞	600	-	-	-	-	-	-	-	-
TCM27-230-020	2.3	0.2	●		3.5	7	∞	600	-	-	-	-	-	-	-	-
TCM27-239-015	2.39	0.15	●		5.7	11.4	∞	600	280	180	130	50	35	-	-	-
TCM27-247-020	2.47	0.2	●		5.7	11.4	∞	600	280	180	130	50	35	-	-	-
TCM27-250-010	2.5	0.1	●		5.7	11.4	∞	600	280	180	130	50	35	-	-	-
TCM27-250-030	2.5	0.3	●		5.7	11.4	∞	600	280	180	130	50	35	-	-	-
TCM27-270-010	2.7	0.1	●		6.2	12.4	∞	600	280	180	135	105	95	85	78	-
TCM27-287-020	2.87	0.2	●		6.2	12.4	∞	600	280	180	135	105	95	85	78	-
TCM27-300-000	3	0	●		6.4	12.8	∞	600	280	180	135	105	95	85	78	55
TCM27-300-020	3	0.2	●		6.4	12.8	∞	600	280	180	135	105	95	85	78	55
TCM27-300-030	3	0.3	●		6.4	12.8	∞	600	280	180	135	105	95	85	78	55
TCM27-300-040	3	0.4	●		6.4	12.8	∞	600	280	180	135	105	95	85	78	55
TCM27-315-015	3.15	0.15	●		6.4	12.8	∞	600	280	180	135	105	95	85	78	68
TCM27-318-020	3.18	0.02	●		6.4	12.8	∞	600	280	180	135	105	95	85	78	68

5 pieces per package
● : Line up

INSERT - FOR GROOVING AND PROFILING

TCM27 (Full R)

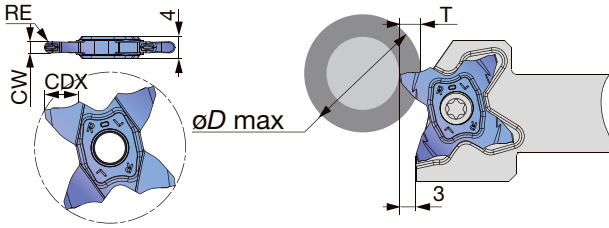

P	Steel	★		
M	Stainless	★		
K	Cast iron	★		
N	Non-ferrous			
S	Superalloys	★		
H	Hard materials			

★ : First choice
☆ : Second choice

Designation	CW±0.02	RE	Coated AH725	CDX	CUTDIA	Relation of groove depth (T) and Max. diameter (øD max)									
						T≤3	T≤3.5	T≤4	T≤4.5	T≤5	T≤5.5	T≤5.7	T≤6	T≤6.2	T≤6.4
TCM27-157-079	1.57	0.79	●	3	6	∞	-	-	-	-	-	-	-	-	-
TCM27-200-100	2	1	●	3	6	∞	-	-	-	-	-	-	-	-	-
TCM27-239-120	2.39	1.2	●	5.7	11.4	∞	600	280	180	130	50	35	-	-	-
TCM27-300-150	3	0.02	●	6.4	12.8	∞	600	280	180	135	105	95	85	78	55

5 pieces per package

● : Line up

STANDARD CUTTING CONDITIONS

ISO	Workpiece material	Grades	Cutting speed Vc (m/min)	Feed: f (mm/rev)						Depth of cut for profiling (with full radius insert)
				Grooving, parting-off		Parting-off (with hand)		Profiling (with full radius insert)		
				TCL27	TCS27	TCM27	TCS27	TCS27	TCM27	
P	Carbon steel S45C, etc. C45, etc.	AH725	100 - 200	0.03 - 0.12	0.05 - 0.15	0.05 - 0.25	0.04 - 0.12	0.05 - 0.10	0.05 - 0.15	0.5
	Alloy steel SCM435, etc. 34CrMo4, etc.	AH725	50 - 180	0.03 - 0.12	0.05 - 0.15	0.05 - 0.25	0.04 - 0.12	0.05 - 0.10	0.05 - 0.15	0.5
M	Stainless steel SUS304, etc. X5CrNi18-9, etc.	AH725	100 - 150	0.03 - 0.12	0.05 - 0.15	0.05 - 0.20	0.04 - 0.12	0.05 - 0.10	0.05 - 0.15	0.5
K	Grey cast iron FC250, etc. 250, etc.	AH725	50 - 180	0.03 - 0.12	0.05 - 0.15	0.05 - 0.25	0.04 - 0.12	0.05 - 0.10	0.05 - 0.15	0.5
	Ductile cast iron FCD400, etc. 400-15, etc.	AH725	50 - 120	0.03 - 0.12	0.05 - 0.15	0.05 - 0.20	0.04 - 0.12	0.05 - 0.10	0.05 - 0.15	0.5
S	Titanium alloys Ti-6Al-4V, etc.	AH725	30 - 60	0.03 - 0.12	0.05 - 0.15	0.05 - 0.15	0.04 - 0.12	0.05 - 0.10	0.05 - 0.10	0.5
	Superalloys Inconel718, etc.	AH725	20 - 50	0.03 - 0.12	0.05 - 0.15	0.05 - 0.15	0.04 - 0.12	0.05 - 0.10	0.05 - 0.10	0.5

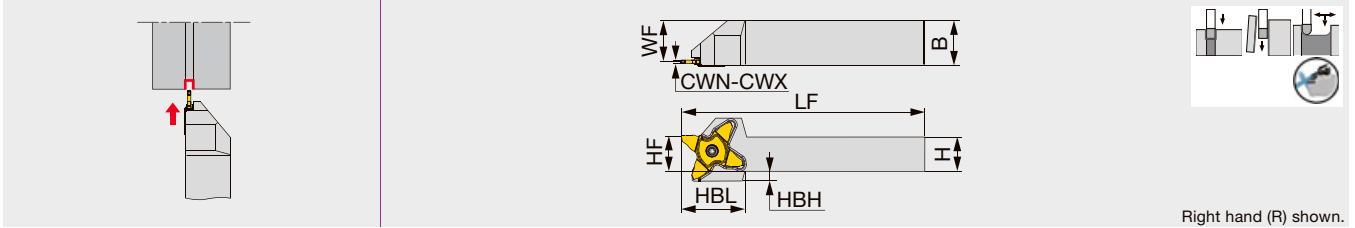

Right hand (R) shown.

Designation	CWN	CWX	H	B	LF	HF	WF	HBH	HBL	Insert	Torque*
STCR/L2020-38	1.5	4	20	20	120	20	18.1	5	35	TCL38...	2.5

Torque*: Recommended clamping torque (N·m)

SPARE PARTS

Designation	Screw	Wrench
STCR****-38 (-CHP)	SR16-212-01397L	T-2010/5
STCL****-38 (-CHP)	SR16-212-01397	T-2010/5

INSERT - FOR GROOVING AND PARTING OFF

TCL38 (for grooving and parting off)

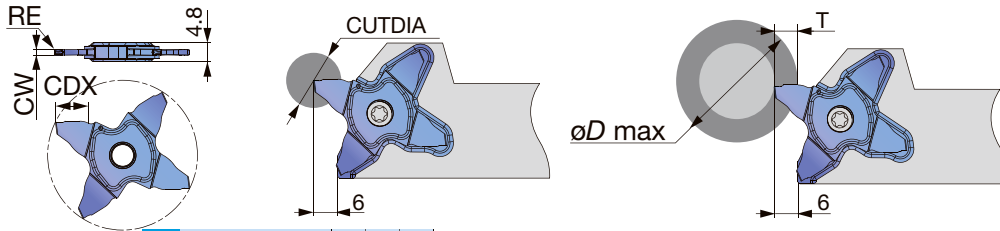

P Steel	★	
M Stainless	★	
K Cast iron	★	
N Non-ferrous		
S Superalloys	★	
H Hard materials		

★ : First choice

Designation	CW±0.02	RE	Coated AH7025	CDX	CUTDIA	Relation of groove depth (T) and Max. diameter (øD max)					
						T ≤ 5	T ≤ 6	T ≤ 7	T ≤ 8	T ≤ 9	T ≤ 10
TCL38-150-020	1.5	0.2	●	9	18	∞	950	315	190	45	-
TCL38-200-020	2	0.2	●	9	18	∞	950	315	190	45	-
TCL38-300-020	3	0.2	●	10	20	∞	950	315	190	130	50
TCL38-400-030	4	0.3	●	10	20	∞	950	315	190	130	50

5 pieces per package

● : Line up

STANDARD CUTTING CONDITIONS

ISO	Workpiece materials	Grades	Cutting speed Vc (m/min)	Feed: f (mm/rev)
				Grooving, Parting TCL38
P	Carbon steel (S45C / C45, etc.)	AH7025	80 - 180	0.03 - 0.18
	Alloy steel (SCM435 / 34CrMo4, etc.)	AH7025	50 - 180	0.03 - 0.18
M	Alloy steel (SCM435 / 34CrMo4, etc.)	AH7025	50 - 150	0.03 - 0.14
K	Grey cast iron (FC250 / 250 / GG25, etc.)	AH7025	50 - 180	0.03 - 0.14
	Ductile cast iron (FCD400 / 400-15 / GGG400, etc.)	AH7025	50 - 120	0.03 - 0.14
S	Titanium alloys (Ti-6Al-4V, etc.)	AH7025	30 - 60	0.03 - 0.14
	Superalloys (Inconel718, etc.)	AH7025	20 - 50	0.03 - 0.14

GTPA-OH

Coolant through

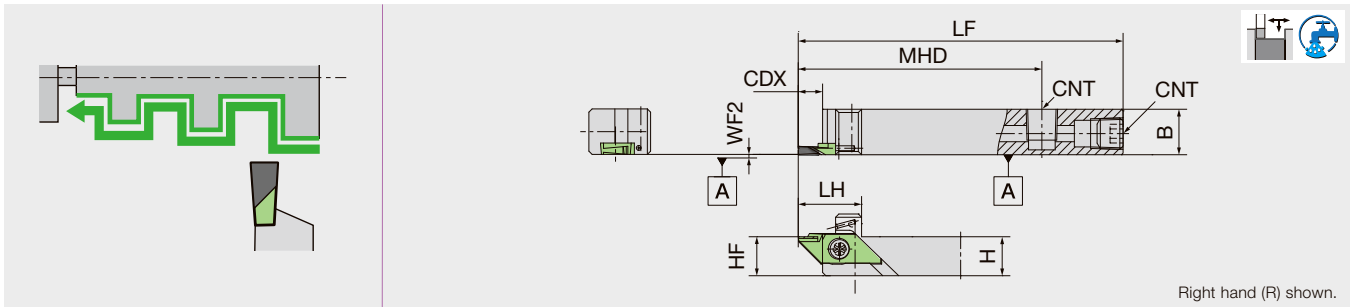

Designation	CW	H	B	LF	LH	CDX	HF	MHD	WF2	CNT	Insert
GTPAR1214H-OH	2 - 2.5	12	14	100	19.5	7.5	12	75	0.1	Rc1/8	GTPA..

SPARE PARTS

Designation	Clamp screw	Screw (for CNT)	Wrench (for Clamp screw)
GTPAR1214H-OH	LRIS-4*12PW	SPR1/8	CLR-15S

GTPA

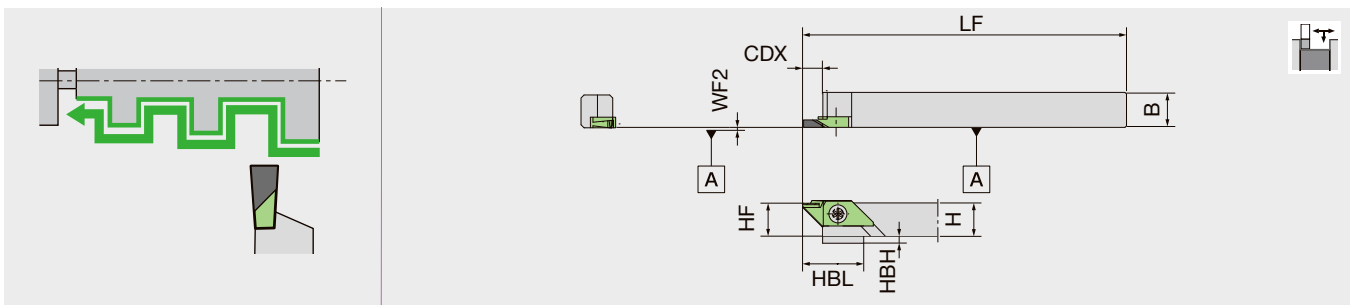

Designation	CW	H	B	LF	HF	CDX	HBH	HBL	WF2	Insert
GTPAR1010	2 - 2.5	10	10	120	10	7.5	2	19.5	0.1	GTPA..
GTPAR1212	2 - 2.5	12	12	120	12	7.5	-	-	0.1	GTPA..
GTPAR1616	2 - 2.5	16	16	120	16	7.5	-	-	0.1	GTPA..

SPARE PARTS

Designation	Clamp screw	Wrench (for Clamp screw)
GTPAR1010	LRIS-4*10PW	CLR-15S
GTPAR1212	LRIS-4*12PW	CLR-15S
GTPAR1616	LRIS-4*12PW	CLR-15S

Y-GTPA-OH

Y-axis coolant through

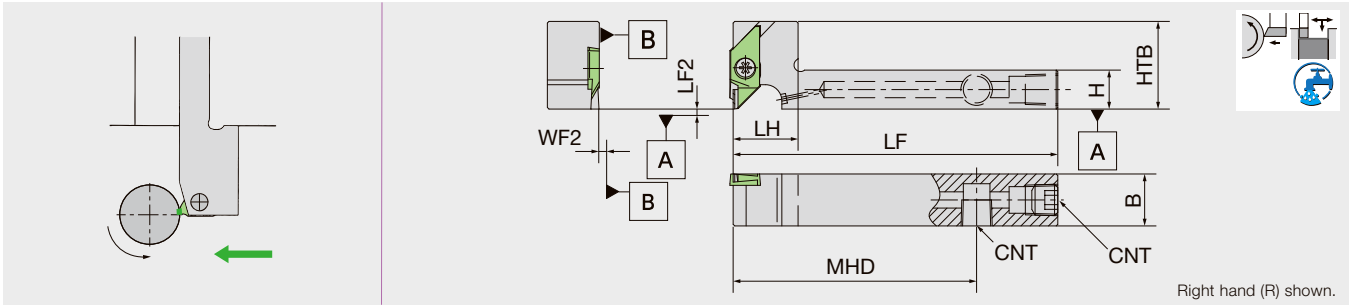

Right hand (R) shown.

Designation	CW	H	B	LH	LF	HTB	LF2	MHD	WF2	CNT	Insert
Y-GTPAR1014FSS-OH	2 - 2.5	10	14	15	80	27	0	55	0.1	M6*1	GTPA..
Y-GTPAR1216HS-OH	2 - 2.5	12	16	20	100	27	0	75	0.1	Rc1/8	GTPA..
Y-GTPAR1616H-OH	2 - 2.5	16	16	25	100	27	0	75	0.1	Rc1/8	GTPA..

NOTE: Use a right-handed (R) insert.

NOTE: There is a risk of interference with the Y-axis holder depending on the combination of the maximum workpiece diameter and machining diameter. →10-1

SPARE PARTS

Designation	Clamp screw	Screw (for CNT)	Wrench (for Clamp screw)
Y-GTPAR1014FSS-OH	LRIS-4*12PW	SS0605SC	CLR-15S
Y-GTPAR1216HS-OH	LRIS-4*12PW	SPR1/8	CLR-15S
Y-GTPAR1616H-OH	LRIS-4*12PW	SPR1/8	CLR-15S

Reference pages : Inserts → 6-57

INSERT

GTPA.. PCD

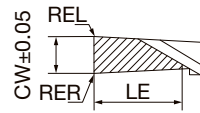
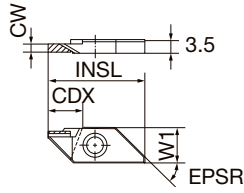
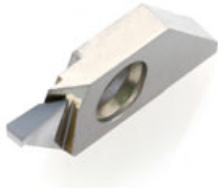

Right hand (R) shown.

P	Steel		
M	Stainless		
N	Non-ferrous	★	
S	Superalloys		
H	Hard materials		

★ : First choice
☆ : Second choice

Designation	HAND	PCD									
		PD1	CW	APMX	CDX	INSL	W1	EPSR	LE	REL	RER
GTPA20FRN01	R	●	2	6	9.2	(25)	9.4	45°	7	0.1MAX	0.1MAX
GTPA20FRN01-SH	R	●	2	3	9.2	25.7	9.4	45°	4	0.1MAX	0.1MAX
GTPA25FRN01	R	●	2.5	6	9.2	(25)	9.4	45°	7	0.1MAX	0.1MAX
GTPA25FRN01-081	R	●	2.5	3	9.2	25.7	9.4	45°	4	0.1MAX	0.1MAX

● : Line up

GTPA.. Carbide

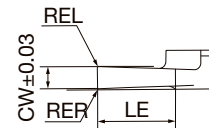
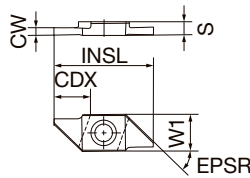
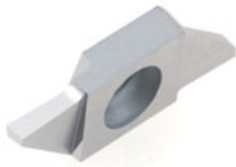

Right hand (R) shown.

P	Steel		
M	Stainless		
N	Non-ferrous	★	
S	Superalloys		
H	Hard materials		

★ : First choice
☆ : Second choice

Designation	HAND	Uncoated									
		KM1	CW	APMX	CDX	INSL	W1	EPSR	LE	REL	RER
GTPA20FRN01	R	●	2	6	9.2	(25)	9.4	45°	7	0.1MAX	0.1MAX
GTPA25FRN01	R	●	2.5	6	9.2	(25)	9.4	45°	7	0.1MAX	0.1MAX

● : Line up

SCRUM DUO GWPG(M).. series/Toolholder

GTWP

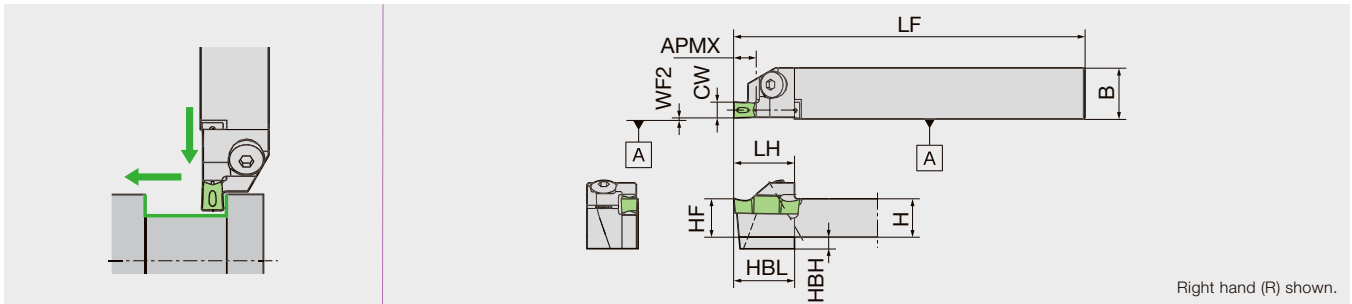

Designation	CW	H	B	LF	LH	APMX	HBH	HBL	HF	WF2	Insert
GTWPR1016-3D07	3	10	16	120	19	7	2	18	10	0.3	GWPG(M)300..
GTWPR1216-3D07	3	12	16	120	19.5	7	-	-	12	0.3	GWPG(M)300..
GTWPR1616-3D09	3	16	16	120	22	9	-	-	16	0.3	GWPG(M)300..
GTWPR1016-4E07	4	10	16	120	19	7	2	18	10	0.3	GWPG(M)400..
GTWPR1216-4E07	4	12	16	120	19.5	7	-	-	12	0.3	GWPG(M)400..
GTWPR1616-4E09	4	16	16	120	22	9	-	-	16	0.3	GWPG(M)400..
GTWPR1016-5F07	5	10	16	120	19	7	2	18	10	0.3	GWPG(M)500..
GTWPR1216-5F07	5	12	16	120	19.5	7	-	-	12	0.3	GWPG(M)500..
GTWPR1616-5F09	5	16	16	120	22	9	-	-	16	0.3	GWPG(M)500..
GTWPR1020-6G07	6	10	20	120	22	7	2	21	10	0.3	GWPG(M)600..
GTWPR1220-6G07	6	12	20	120	22.5	7	-	-	12	0.3	GWPG(M)600..
GTWPR1620-6G09	6	16	20	120	25	9	-	-	16	0.3	GWPG(M)600..
GTWPL1216-3D07	3	12	16	120	19.5	7	-	-	12	0.3	GWPG(M)300..
GTWPL1616-3D09	3	16	16	120	22	9	-	-	16	0.3	GWPG(M)300..
GTWPL1216-4E07	4	12	16	120	19.5	7	-	-	12	0.3	GWPG(M)400..
GTWPL1616-4E09	4	16	16	120	22	9	-	-	16	0.3	GWPG(M)400..
GTWPL1216-5F07	5	12	16	120	19.5	7	-	-	12	0.3	GWPG(M)500..
GTWPL1616-5F09	5	16	16	120	22	9	-	-	16	0.3	GWPG(M)500..
GTWPL1620-6G09	6	16	20	120	25	9	-	-	16	0.3	GWPG(M)600..

Note: Max. Bar Dia. ϕ 42

SPARE PARTS



Designation	Clamp screw	Wrench (for Clamp screw)
GTWPR10**	AOB-5*14	LW-3S
GTWPR/12L**	AOB-5*16	LW-3S
GTWPR/L16**	AOB-5*16	LW-3S

INSERT

GWPG(M)-GW with chipbreaker

Best for side turning

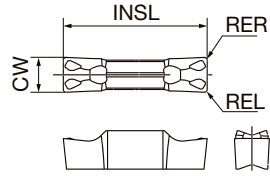

P	Steel	★
M	Stainless	☆
N	Non-ferrous	☆
S	Superalloys	★
H	Hard materials	☆

★ : First choice
☆ : Second choice

Designation	Coated	CW	INSL	REL	RER
	DM4				
GWPG300N02D-GW	●	3	20.6	0.2	0.2
GWPG300N04D-GW	●	3	20.6	0.4	0.4
GWPG400N02E-GW	●	4	20.6	0.2	0.2
GWPG400N04E-GW	●	4	20.6	0.4	0.4
GWPG400N08E-GW	●	4	20.6	0.8	0.8
GWPG500N02F-GW	●	5	20.6	0.2	0.2
GWPG500N04F-GW	●	5	20.6	0.4	0.4
GWPG500N08F-GW	●	5	20.6	0.8	0.8
GWPG600N02G-GW	●	6	25.6	0.2	0.2
GWPG600N04G-GW	●	6	25.6	0.4	0.4
GWPG600N08G-GW	●	6	25.6	0.8	0.8
GWPM300N04D-GW	●	3	20.6	0.4	0.4
GWPM400N04E-GW	●	4	20.6	0.4	0.4
GWPM500N04F-GW	●	5	20.6	0.4	0.4
GWPM600N04G-GW	●	6	25.6	0.4	0.4

GWPG.. : Outside ground
Width tolerance ±0.025
GWPM.. : Full-molded
Width tolerance ±0.05

● : Line up

Grade 1
Insert 2
Ext. Toolholder 3
Int. Toolholder 4
Threading 5
Grooving 6
Shaper 7
Endmill 8
Drilling Tool 9
Technical Reference 10

GWPG-GV with chipbreaker

Less tool pressure design

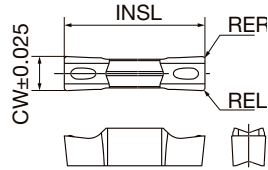

P Steel	★
M Stainless	☆
N Non-ferrous	
S Superalloys	★
H Hard materials	☆

★ : First choice
☆ : Second choice

Designation	Coated	CW	INSL	REL	RER
	DM4				
GWPG300N02D-GV	●	3	20.6	0.2	0.2
GWPG300N04D-GV	●	3	20.6	0.4	0.4
GWPG400N02E-GV	●	4	20.6	0.2	0.2
GWPG400N04E-GV	●	4	20.6	0.4	0.4
GWPG500N02F-GV	●	5	20.6	0.2	0.2
GWPG500N04F-GV	●	5	20.6	0.4	0.4
GWPG600N02G-GV	●	6	25.6	0.2	0.2
GWPG600N04G-GV	●	6	25.6	0.4	0.4

● : Line up

TUNGHEAVY GROOVE FPGN

Lever-lock toolholder for external wide grooving and profiling

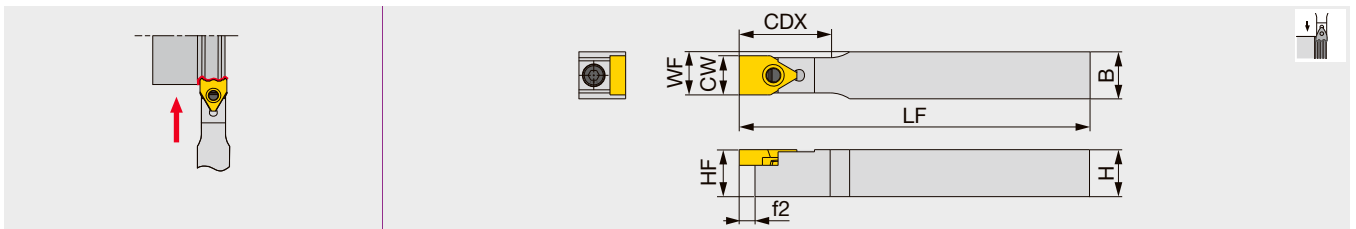

Designation	CW	CDX	H	B	LF	HF	WF	f2	Insert
FPGN1212X-10T20	10	25	12	12	125	12	11	5.5	PSGB10...
FPGN1616X-10T20	10	25	16	16	125	16	13	5.5	PSGB10...
FPGN2020K-10T20	10	25	20	20	130	20	15	5.5	PSGB10...
FPGN1616X-15T25	15	30	16	16	125	16	15.5	5.5	PSGB15...
FPGN2020K-15T25	15	30	20	20	130	20	17.5	5.5	PSGB15...
FPGN2020K-20T32	20	37	20	20	130	20	20	5.5	PSGB20...

PSGB insert blank is available for tailored inserts.

SPARE PARTS



Designation	Lever	Clamping screw	Spring	Wrench
FPGN****-10T..., 15T...	FCL4	FCS3	BP-5	P-2.5
FPGN****-20T..., 25T...	FCL8	FCS6	BP-9	P-5

Reference pages : GWPG-GV with chipbreaker: Toolholders → 6-58

INSERT

PSGB (Blank for wide profile grooving inserts*)

Specially tailored profile insert

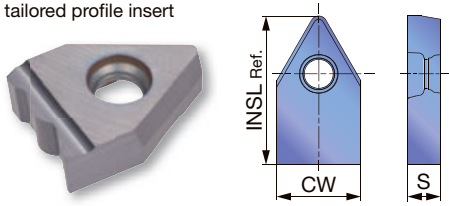

Designation	CW±0.025	Uncoated						INSL	S
		TH10	UX30						
PSGB10	10.2	●	●					18	4
PSGB15	15.2	●	●					20	5
PSGB20	20.2	●	●					27	6.5
PSGB25	25.2	●	●					27	6.5

P Steel	☆	★						
M Stainless		★						
K Cast iron	★							
N Non-ferrous	★							
S Superalloys	☆							
H Hard materials								

★ : First choice
☆ : Second choice

These are blanks (semi-finished products) for wide profile grooving inserts that can be tailored. Package quantity = 5pcs.
● : Line up

STANDARD CUTTING CONDITIONS

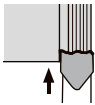

Wide profile grooving

ISO	Workpiece material	Hardness (HB)	Grade	Cutting speed Vc (m/min)
P	Steel S45C, etc. C45, etc.	< 200	UX30	50 - 150
	Alloy steel SCM440, etc. 42CrMo4, etc.	< 300	UX30	50 - 120
M	Stainless steel SUS303, etc. X5CrNi18-9, etc.	< 200	UX30	50 - 120
K	Grey cast iron FC250, etc. 250, etc.	-	TH10	50 - 150
	Ductile cast iron FCD450, etc. 450-10S, etc.	-	TH10	50 - 120
N	Aluminium alloy Si < 12%, etc.	-	TH10	100 - 500

- Custom shaped inserts can be supplied on customer's request, according to the designated final shape on part drawing.
- Semi-finished blanks PSGB types are offered for purchase.

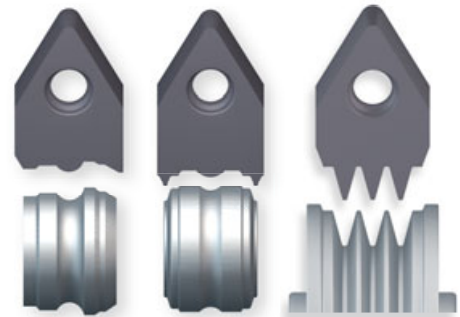

Grade 1
Insert 2
Ext. Toolholder 3
Int. Toolholder 4
Threading 5
Grooving 6
Shaper 7
Endmill 8
Drilling Tool 9
Technical Reference 10

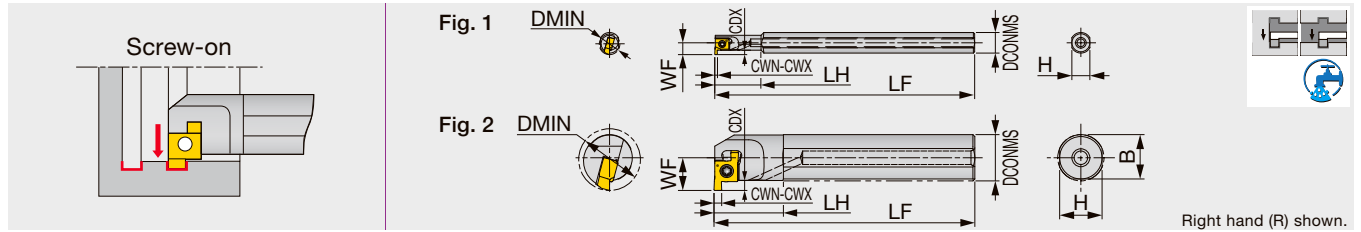

Right hand (R) shown.

Designation	Material	CWN	CWX	DMIN	CDX	DCONMS	H	B	LF	LH	WF	Insert	Torque* Fig.
A08H-SNGR06-D080	Steel	1	2	8	1.5	8	7	-	100	18	4.73	6GMR..., 6GR...	0.7 1
A08H-SNGR07-D100	Steel	1	2	10	1.5	8	7	-	100	23	5.8	7GMR..., 7GR...	1.0 1
A10K-SNGR07-D120	Steel	1	2	12	1.5	10	9	-	125	29	6.8	7GMR..., 7GR...	1.0 1
A10K-SNGR08-D140	Steel	1.5	3.5	14	2	10	9	-	125	15	7.6	8GMR..., 8GR...	1.0 2
A12M-SNGR08-D160	Steel	1.5	3.5	16	2	12	11	11.5	150	18	8.6	8GMR..., 8GR...	1.0 2
A16Q-SNGR09-D200	Steel	1.5	3.5	20	3	16	15	15.5	180	20	11.6	9GMR..., 9GR...	1.3 2
A20R-SNGR09-D240	Steel	1.5	3.5	24	3	20	18	19	200	25	13.6	9GMR..., 9GR...	1.3 2
E08X-SNGR07-D100	Carbide	1	2	10	1.5	8	7.5	-	120.5	35	5.8	7GMR..., 7GR...	1.0 1
E10X-SNGR07-D120	Carbide	1	2	12	1.5	10	9	-	143.5	45	6.8	7GMR..., 7GR...	1.0 1
E10X-SNGR08-D140	Carbide	1.5	3.5	14	2	10	9	-	146	-	7.6	8GMR..., 8GR...	1.0 2
E12X-SNGR08-D160	Carbide	1.5	3.5	16	2	12	11	-	174.8	-	8.6	8GMR..., 8GR...	1.0 2
E16X-SNGR09-D200	Carbide	1.5	3.5	20	3	16	15	-	194.6	-	11.6	9GMR..., 9GR...	1.5 2

Note: Use the right-hand insert (□GR) with the right-hand holder (□NGR).
Torque*: Recommended clamping torque (N·m)

SPARE PARTS

Designation	Clamping screw	Wrench
A**-SNGR06-D...	CSTB-2L040	T-6F
A**-SNGR07-D...	CSTB-2.2S	T-7F
A**-SNGR08-D...	CSTB-2.2	T-7F
A**-SNGR09-D...	CSTB-2.5L080	T-8F
E**-SNGR07-D...	CSTB-2.2S	T-7F
E**-SNGR08-D...	CSTB-2.2	T-7F
E**-SNGR09-D...	CSTB-2.5L080	T-8F

INSERTS

**GMR/L

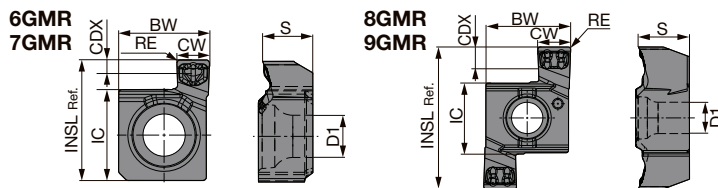

Single edge

Double edge

Right hand (R) shown.

	P	M	K	N	S	H
Steel	★					
Stainless	★					
Cast iron	★					
Non-ferrous				★		
Superalloys					★	
Hard materials						★

★ : First choice
☆ : Second choice

Designation	HAND	CW±0.025	RE	Coated						CDX	BW	S	IC	INSL	D1
				AH7025											
6GMR100-015	R	1	0.15	●						1.5	5.56	2.34	4.76	6.44	2.3
7GMR200-020	R	2	0.2	●						1.5	5.56	3.08	5.56	7.36	2.58
8GMR150-020	R	1.5	0.2	●						2	6.15	3.87	5.56	10.16	2.58
9GMR200-020	R	2	0.2	●						3	7.74	4.66	6.35	12.95	2.86
9GMR300-020	R	3	0.2	●						3	7.74	4.66	6.35	12.95	2.86

● : Line up

Reference pages: A/E-SNGR: Standard cutting conditions → 6-65

INSERT

**GR/L

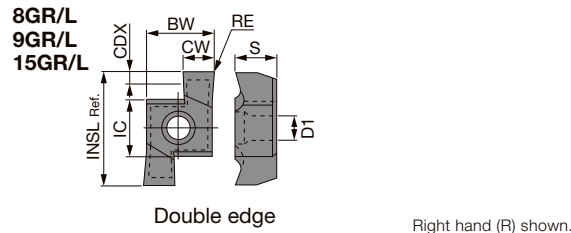
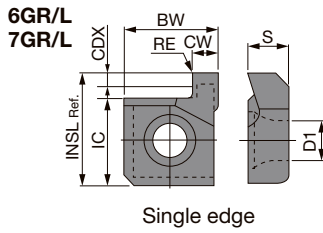

Right hand (R) shown.

P	Steel	★				★				
M	Stainless									★
K	Cast iron	☆				★				
N	Non-ferrous					★				
S	Superalloys					☆				
H	Hard materials									

★ : First choice
☆ : Second choice

Designation	HAND	CW±0.025	RE	Cermet		Uncoated		CDX	BW	S	IC	INSL	D1
				NS9530		TH10	UX30						
6GR100	R	1	0.2	●		●	●	1.5	5.6	2.34	4.76	6.44	2.3
6GL100	L	1	0.2			●	●	1.5	5.6	2.34	4.76	6.44	2.3
6GR150	R	1.5	0.2	●		●	●	1.5	5.6	2.34	4.76	6.44	2.3
6GL150	L	1.5	0.2			●	●	1.5	5.6	2.34	4.76	6.44	2.3
6GR200	R	2	0.2	●		●	●	1.5	5.6	2.34	4.76	6.44	2.3
6GL200	L	2	0.2			●	●	1.5	5.6	2.34	4.76	6.44	2.3
7GR100	R	1	0.2	●		●	●	1.5	5.6	3.08	5.56	7.36	2.58
7GR150	R	1.5	0.2	●		●	●	1.5	5.6	3.08	5.56	7.36	2.58
7GR200	R	2	0.2	●		●	●	1.5	5.6	3.08	5.56	7.36	2.58
7GL200	L	2	0.2			●	●	1.5	5.6	3.08	5.56	7.36	2.58
8GR150	R	1.5	0.2	●		●	●	2	6.2	3.87	5.56	10.16	2.58
8GR200	R	2	0.2	●		●	●	2	6.2	3.87	5.56	10.16	2.58
8GL200	L	2	0.2			●	●	2	6.2	3.87	5.56	10.16	2.58
8GR250	R	2.5	0.2	●		●	●	2	6.2	3.87	5.56	10.16	2.58
8GL250	L	2.5	0.2			●	●	2	6.2	3.87	5.56	10.16	2.58
8GR300	R	3	0.2	●		●	●	2	6.2	3.87	5.56	10.16	2.58
8GL300	L	3	0.2			●	●	2	6.2	3.87	5.56	10.16	2.58
8GR350	R	3.5	0.2	●		●	●	2	6.2	3.87	5.56	10.16	2.58
9GR150	R	1.5	0.2	●		●	●	2	7.7	4.66	6.35	12.95	2.86
9GL150	L	1.5	0.2	●		●	●	2	7.7	4.66	6.35	12.95	2.86
9GR200	R	2	0.2	●		●	●	3	7.7	4.66	6.35	12.95	2.86
9GL200	L	2	0.2	●		●	●	3	7.7	4.66	6.35	12.95	2.86
9GR250	R	2.5	0.2	●		●	●	3	7.7	4.66	6.35	12.95	2.86
9GL250	L	2.5	0.2	●		●	●	3	7.7	4.66	6.35	12.95	2.86
9GR300	R	3	0.2	●		●	●	3	7.7	4.66	6.35	12.95	2.86
9GL300	L	3	0.2	●		●	●	3	7.7	4.66	6.35	12.95	2.86
9GR350	R	3.5	0.2	●		●	●	3	7.7	4.66	6.35	12.95	2.86
9GL350	L	3.5	0.2	●		●	●	3	7.7	4.66	6.35	12.95	2.86
15GR200	R	2	0.2	●		●	●	3	10.8	5.1	9.2	20.8	4.8
15GR250	R	2.5	0.2	●		●	●	3	10.8	5.1	9.2	20.8	4.8
15GR300	R	3	0.2	●		●	●	3	10.8	5.1	9.2	20.8	4.8
15GL300	L	3	0.2			●	●	3	10.8	5.1	9.2	20.8	4.8
15GR350	R	3.5	0.2	●		●	●	3	10.8	5.1	9.2	20.8	4.8
15GR400	R	4	0.2	●		●	●	4	10.8	5.1	9.2	20.8	4.8
15GR450	R	4.5	0.2	●		●	●	4	10.8	5.1	9.2	20.8	4.8
15GL450	L	4.5	0.2			●	●	4	10.8	5.1	9.2	20.8	4.8
15GR500	R	5	0.2	●		●	●	5	10.8	5.1	9.2	20.8	4.8

Note: Use the right-hand insert (□GR) with the right-hand holder (□NGR), and use the left-hand insert (□GL) with the left-hand holder (□NGL).

● : Line up

STANDARD CUTTING CONDITIONS

ISO	Workpiece material	Grade	Cutting speed Vc (m/min)	Feed rate: f (mm/rev)	
				**GMR...	**GR/L...
P	Carbon steel S45C, C45, etc.	AH7025	80 - 180	0.03 - 0.12	-
		NS9530	80 - 200	-	0.05 - 0.15
		UX30	40 - 150	-	0.05 - 0.15
	Alloy steel SCM435, 34CrMo4, etc.	AH7025	80 - 180	0.03 - 0.12	-
		NS9530	80 - 200	-	0.05 - 0.15
		UX30	40 - 150	-	0.05 - 0.15
M	Stainless steel SUS304, X5CrNi18-9, etc.	AH7025	50 - 120	0.03 - 0.12	-
		UX30	40 - 100	-	0.03 - 0.10
K	Grey cast irons F250, GG25, 250, etc.	AH7025	50 - 220	0.03 - 0.12	-
		TH10	60 - 200	-	0.05 - 0.15
	Ductile cast irons FCD400, etc.	AH7025	50 - 180	0.03 - 0.12	-
		TH10	40 - 160	-	0.05 - 0.15
S	Titanium alloys Ti-6Al-4V, etc.	AH7025	30 - 80	0.03 - 0.12	-
		TH10	20 - 50	-	0.05 - 0.08
	Superalloys Inconel718, etc.	AH7025	20 - 60	0.03 - 0.12	-
TH10		10 - 30	-	0.03 - 0.08	



TINYCUT^{INTERNAL} A/E-SMR

Screw-on boring bar

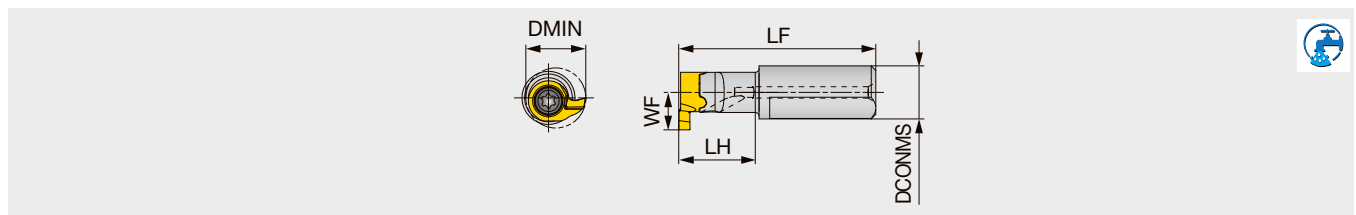

Designation	Material	DCONMS	LH	LF	Insert	Torque*
A07080-SMR4	Steel	7	8	24	M*R4...	0.5
E07120-SMR4	Carbide	7	12	29	M*R4...	0.5
A07100-SMR5	Steel	7	10	26	M*R5...	1.3
E07180-SMR5	Carbide	7	18	34	M*R5...	1.3

*Torque: Recommended clamping torque (N·m)

For A/E-SMR4, the above LF and LH dimensions are true with MGR4100F000-D05 insert assembled.

For A/E-SMR5, the above LF and LH dimensions are true with MGR5150F003-D07 insert assembled.

The DMIN and WF sizes vary depending on the insert sizes used.

SPARE PARTS

Designation	Clamping screw	Wrench
A/E07**-SMR4	CSPB-1.8L3.6	IP-6F
A/E07**-SMR5	CSTB-2.5L054DR	T-7F

INSERT

MGR

Grooving

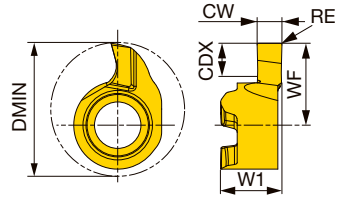

P	Steel	★						
M	Stainless	★						
K	Cast iron	★						
N	Non-ferrous							
S	Superalloys	★						
H	Hard materials							

★ : First choice

Designation	CW	RE	Coated							CDX	DMIN	WF	W1
			SH7025										
MGR4100F000-D05	1	0	●							1	5	2.95	2.3
MGR5100F003-D07	1	0.03	●							1	7	3.95	3.7
MGR5150F003-D07	1.5	0.03	●							1	7	3.95	3.7
MGR5100F003-D08	1	0.03	●							2	8	4.95	3.7
MGR5150F010-D08	1.5	0.1	●							2	8	4.95	3.7
MGR5200F020-D08	2	0.2	●							2	8	4.95	3.7

● : Line up

Grade

Insert

Ext. Toolholder

Int. Toolholder

Threading

Grooving

Shaper

Endmill

Drilling Tool

Technical Reference

S-BG

Mogul Bar / Steel shank

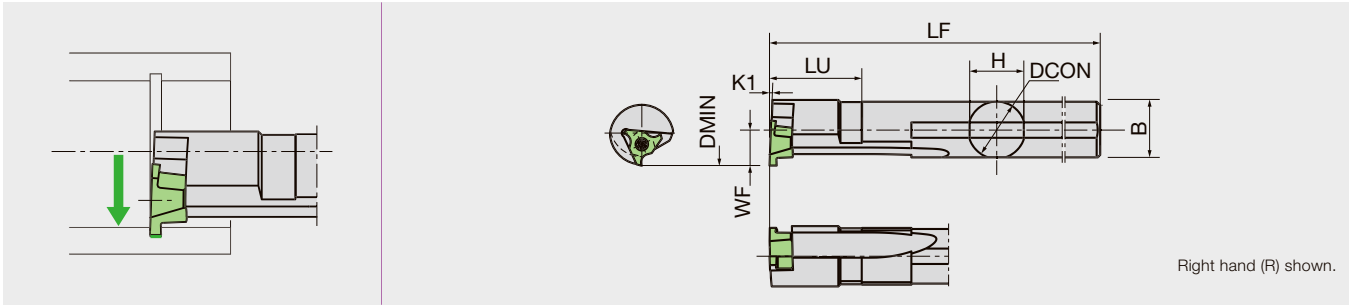

Designation	CW	H	B	LF	DMIN	APMX	DCON	K1	LU	WF	Insert
S08H-BGR10D10	0.5 - 2	7.7	7.85	120	10	1	8	2°	20	5	GTG10..
S10K-BGR10D12	0.5 - 2	9.6	9.8	120	12	1	10	2°	25	6	GTG10..

NOTE: Use a left-handed insert.

SPARE PARTS

Designation	Clamp screw	Wrench (for Clamp screw)
S**-BGR10**	LR-S-2.5*6.8	CLR-15S

INSERT

GTG..005

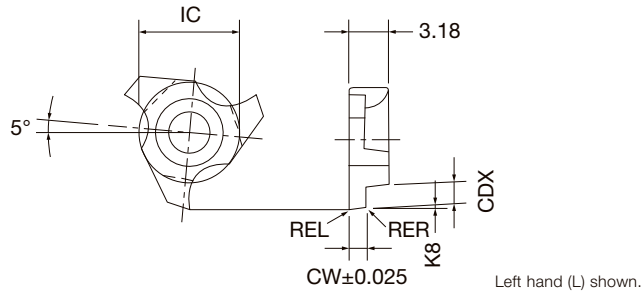

P	Steel	★	
M	Stainless	★	
N	Non-ferrous	★	
S	Superalloys		
H	Hard materials		

★ : First choice
☆ : Second choice

Designation	HAND	Coated	CW	APMX	CDX	IC	EPSR	K8	REL	RER
		TM4								
GTG10050FL005	L	●	0.5	1	1.2	5.56	60°	2°	0.05	0.05
GTG10075FL005	L	●	0.75	1	1.2	5.56	60°	2°	0.05	0.05
GTG10100FL005	L	●	1	1	1.2	5.56	60°	2°	0.05	0.05
GTG10150FL005	L	●	1.5	1	1.2	5.56	60°	2°	0.05	0.05
GTG10200FL005	L	●	2	1	1.2	5.56	60°	2°	0.05	0.05

● : Line up

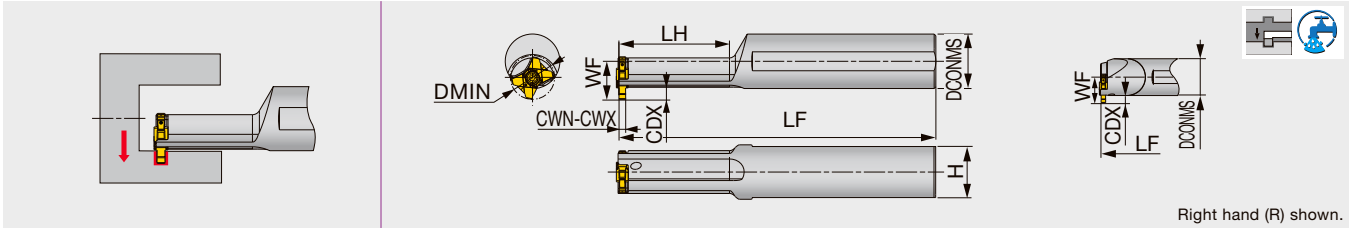

Designation	Material	CWN	CWX	DMIN	DCONMS	LH	LF	WF	H	Insert	Torque*
A12H-STCIR/L10-D105	Steel	1.5	3	10.5	12	25	100	8.3	11	TCIG10...	1
A12H-STCIR/L10-D120	Steel	1.5	3	12	12	31	100	8.3	11	TCIG10...	1
E12K-STCIR/L10-D150	Carbide	1.5	3	15	12	-	125	8.3	11	TCIG10...	1
A16J-STCIR/L12-D130	Steel	1.5	3	13	16	33	110	11.3	15	TCIG12...	1.3
A16J-STCIR/L12-D160	Steel	1.5	3	16	16	41	110	11.3	15	TCIG12...	1.3
E16M-STCIR/L12-D200	Carbide	1.5	3	20	16	-	150	11.3	15	TCIG12...	1.3

Torque*: Recommended clamping torque (N-m)

SPARE PARTS



Designation	Clamping screw
A/E-STCIR10-...	CSTB-2.2L053DR
A/E-STCIR10-...	CSTB-2.2L053DL
A/E-STCIR12-...	CSTB-2.5L054DR
A/E-STCIR12-...	CSTB-2.5L054DL

INSERTS

TCIG

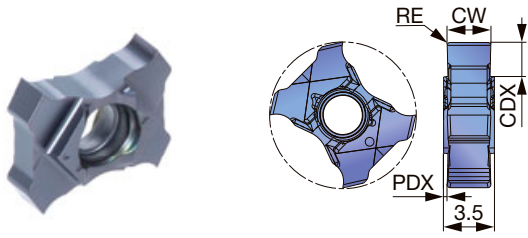

P	Steel	★							
M	Stainless	★							
K	Cast iron	★							
N	Non-ferrous								
S	Superalloys	★							
H	Hard materials								

★ : First choice

Designation	CW±0.025	RE	Coated							CDX	PDX
			AH725								
TCIG10-050-005	0.5	0.05	●							1	1.5
TCIG10-122-008	1.22	0.08	●							2	1.14
TCIG10-142-008	1.42	0.08	●							2	1.04
TCIG10-150-010	1.5	0.1	●							2	1
TCIG10-172-008	1.72	0.08	●							2	0.89
TCIG10-200-010	2	0.1	●							2	0.75
TCIG10-250-020	2.5	0.2	●							2	0.5
TCIG10-300-020	3	0.2	●							2	0.25
TCIG12-100-010	1	0.1	●							2.5	1.25
TCIG12-150-010	1.5	0.1	●							3	1
TCIG12-197-008	1.97	0.08	●							3	0.77
TCIG12-200-020	2	0.2	●							3	0.75
TCIG12-224-008	2.24	0.08	●							3	0.63
TCIG12-250-020	2.5	0.2	●							3	0.5
TCIG12-277-015	2.77	0.15	●							3	0.37
TCIG12-300-020	3	0.2	●							3	0.25

● : Line up

Shallower groove depths (T max) for smaller bores

Maximum groove depths (T max) for TCIG10 inserts are smaller than the CDX value shown above when the grooving bore diameter is < 12 mm; and for TCIG12, when the bore diameter is < 16 mm.

See the chart below for T max values in relation to the given bore diameter.

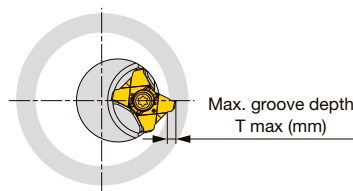
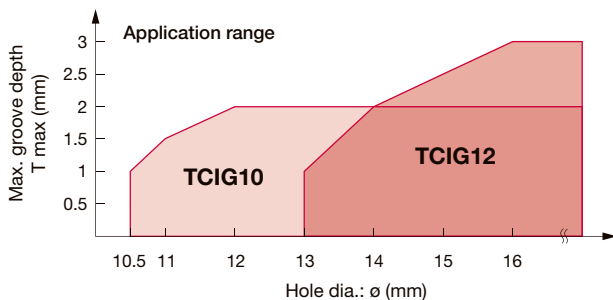

STANDARD CUTTING CONDITIONS

ISO	Workpiece material	Hardness	Priority	Cutting speed Vc (m/min)	Feed f (mm/rev)
P	Steel S45C, C45, SCM435, 34CrMo4, etc.	< 300 HB	First choice	30 - 80	0.01 - 0.05
M	Stainless steel SUS303, X10CrNiS18-9, etc.	< 200 HB	First choice	30 - 50	0.01 - 0.05
S	Titanium alloys Ti-6Al-4V, etc.	< HRC 40	First choice	10 - 50	0.01 - 0.05

Internal grooving and turning toolholder

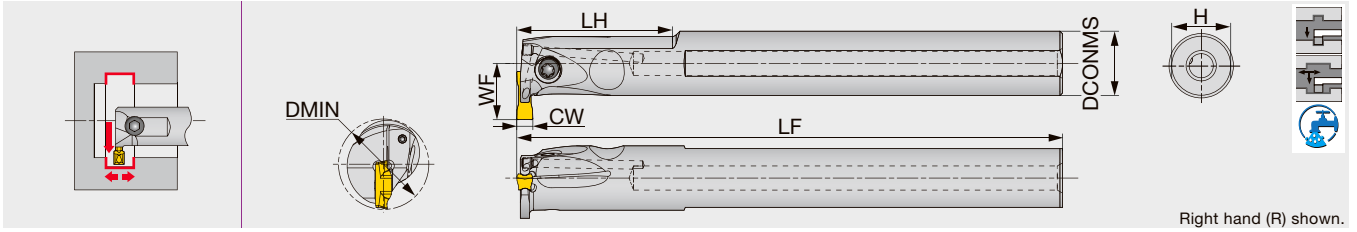

Designation	CW	DMIN	Seat size	CDX	DCONMS	H	LF ⁽¹⁾	LH	WF	Insert	Torque*
CTIR10S2T03-D120	2	12	S2	3	10	9	100	22	8.4	D**2S...	1.3
CTIR12S2T04-D160	2	16	S2	4	12	11	100	28	10.5	D**2S...	2.3
CTIR16S2T06-D200	2	20	S2	6	16	15	110	36	14.5	D**2S...	3.5
CTIR12S3T04-D160	3	16	S3	4	12	11	100	28	10.5	D**3S...	2.3
CTIR16S3T06-D200	3	20	S3	6	16	15	110	36	14.5	D**3S...	3.5

(1) LF is calculated with the groove width CW in the above table.
*Torque: Recommended clamping torque (N·m)

SPARE PARTS

Designation	Clamping screw	Wrench
CTIR10S2T03-D120	CSTB-2.5L080	T-8F
CTIR12S2T04-D160	CSTB-3.5D	T-9F
CTIR16S2T06-D200	CSTB-4	T-15F

INSERT

DGS*S

Internal grooving and parting

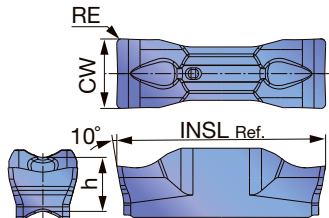

P Steel	★										
M Stainless	★										
K Cast iron	★										
N Non-ferrous											
S Superalloys	★										
H Hard materials											★ : First choice

Designation	Seat size	CW±0.05	RE	Coated							INSL	h
				AH7025								
DGS2S-010	S2	2	0.1	●							9	2.2
DGS3S-020	S3	3	0.2	●							9	2.2

● : Line up

Face grooving toolholder with round shank

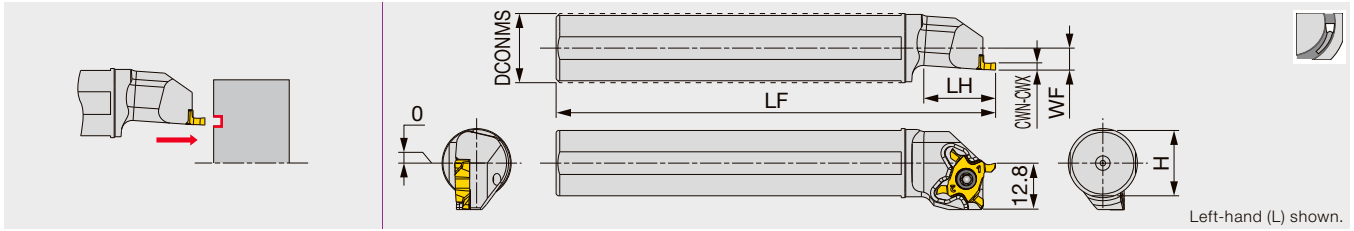

Designation	CWN	CWX	DCONMS	LF	LH	H	WF	Insert	Torque*
JS16F-STCFL18	0.5	2.5	16	85	20	15	6	TCF18L...	1.2
JS19G-STCFL18	0.5	2.5	19.05	90	20	18	6	TCF18L...	1.2
JS19X-STCFL18	0.5	2.5	19.05	120	20	18	6	TCF18L...	1.2
JS20G-STCFL18	0.5	2.5	20	90	20	19	6	TCF18L...	1.2
JS20X-STCFL18	0.5	2.5	20	120	20	19	6	TCF18L...	1.2
JS22X-STCFL18	0.5	2.5	22	120	20	21	6	TCF18L...	1.2
JS25H-STCFL18	0.5	2.5	25	100	20	24	6	TCF18L...	1.2
JS254X-STCFL18	0.5	2.5	25.4	120	20	24.5	6	TCF18L...	1.2

Note: The left hand insert (L) is used for the left hand toolholders (L).
Torque*: Recommended clamping torque: N·m

STCFVR-18

Face grooving toolholder with square shank, for Swiss lathes

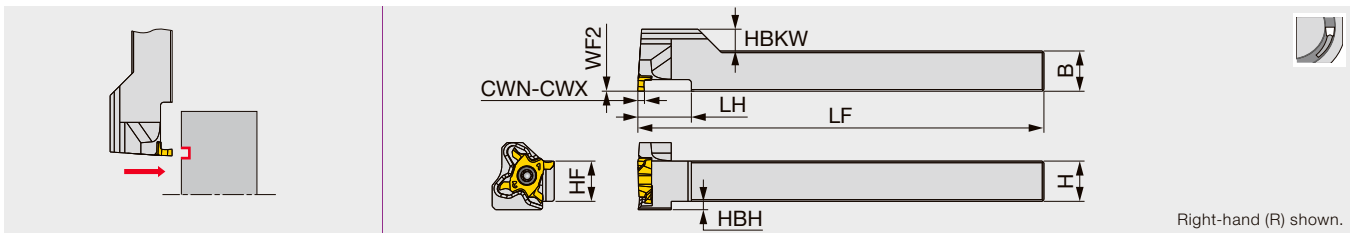

Designation	CWN	CWX	H	B	LF	LH	HF	WF2	HBKW	HBH	Insert	Torque*
STCFVR1010H18	0.5	2.5	10	10	100	12	10	0	8.5	4.5	TCF18L...	1.2
STCFVR1212F18	0.5	2.5	12	12	85	16	12	0	6.5	2.5	TCF18L...	1.2
STCFVR1212X18	0.5	2.5	12	12	120	16	12	0	6.5	2.5	TCF18L...	1.2
STCFVR1616X18	0.5	2.5	16	16	120	20	16	0	2.5	0	TCF18L...	1.2

Note: The left hand insert (L) is used for the right hand toolholders (R).
Torque*: Recommended clamping torque: N·m

SPARE PARTS

Designation	Clamping screw	Wrench
JS**-STCFL18, STCFVR**18, STCL**18	CSTC-4L100DR	T-1008/5

Threading pitch range: 0.8 - 3 mm

INSERT

TCF18L (Face grooving)

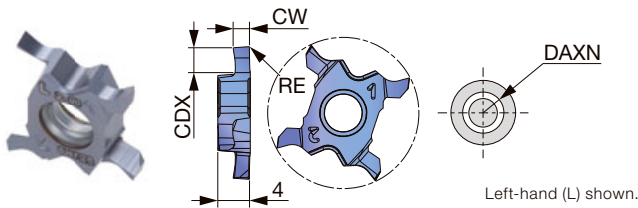

P	Steel	★	★						
M	Stainless	★	★						
K	Cast iron	★	★						
N	Non-ferrous								
S	Superalloys	★	★						
H	Hard materials								★: First choice

Designation	HAND	CW±0.02	RE	Coated		CDX	DAXN
				SH725	SH725		
TCF18L050F-005	L	0.5	0.05	●	●	1	6
TCF18L100F-005	L	1	0.05	●	●	2.5	6
TCF18L150F-005	L	1.5	0.05	●	●	2.5	6
TCF18L200F-005	L	2	0.05	●	●	3	6
TCF18L250F-005	L	2.5	0.05	●	●	3	6

5 pieces per package
●: Line up

STANDARD CUTTING CONDITIONS

TCF18L (Face grooving)

ISO	Workpiece materials	Grades	Cutting speed Vc (m/min)	Feed f (mm/rev)
P	Low carbon steel S15C, C15E, C15E4, S20C, C20, etc.	SH725	30 - 100	0.01 - 0.04
	Carbon steels, Alloy steel S55C, C55, SCM440, 42CrMoS4, etc.	SH725	30 - 100	0.01 - 0.04
	Prehardened steel NAK80, PX5, etc.	SH725	30 - 100	0.01 - 0.04
M	Stainless steel SUS304, X5CrNi18-9, X5CrNiMo17-12-2, etc.	SH725	30 - 100	0.01 - 0.04
K	Grey cast iron FC250, GG25, 250, FC300, GG30, 300, etc.	SH725	30 - 100	0.01 - 0.04
	Ductile cast iron FCD400, 400-15, FCD600, GGG60, 600-3, etc.	SH725	30 - 100	0.01 - 0.04
S	Titanium alloys Ti-6Al-4V, etc.	SH725	20 - 40	0.01 - 0.04
	Superalloys Inconel718, etc.	SH725	10 - 30	0.01 - 0.04

PRECAUTIONS OF PROCESSING

Minimum diameter for face grooving

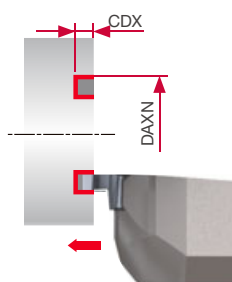

Designation	Minimum face diameter DAXN (mm)	Maximum groove depth CDX (mm)
TCL18, TCP18, TCS18, TCL18	65	3

FGV

For Gang-style machine

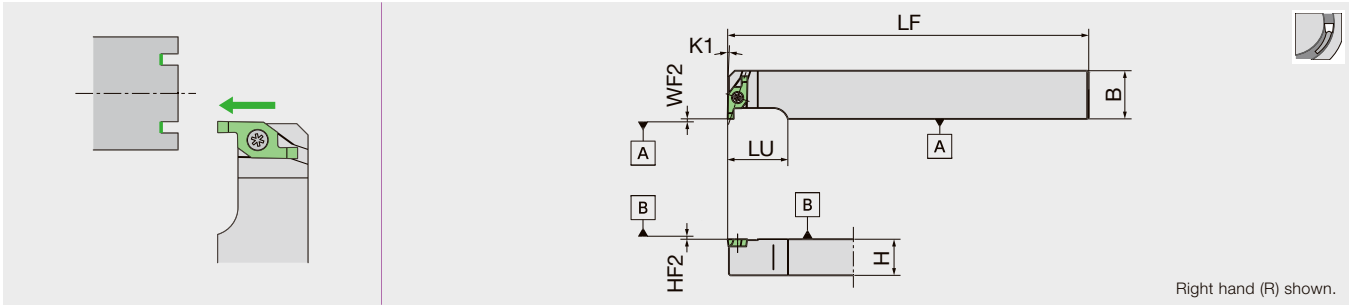

Designation	CW	H	B	LF	HF2	K1	LU	WF2	Insert
FGVR1016	1 - 2	10	16	120	0	1°	20	0	FGV..
FGVR1216	1 - 2	12	16	120	0	1°	20	0	FGV..
FGVR1616	1 - 2	16	16	120	0	1°	20	0	FGV..

NOTE: Use a left-handed insert.

SPARE PARTS



Designation	Clamp screw	Wrench (for Clamp screw)
FGVR**	LRIS-2.5*7	CLR-15S

CH-FGV

For horizontal gang style tool post

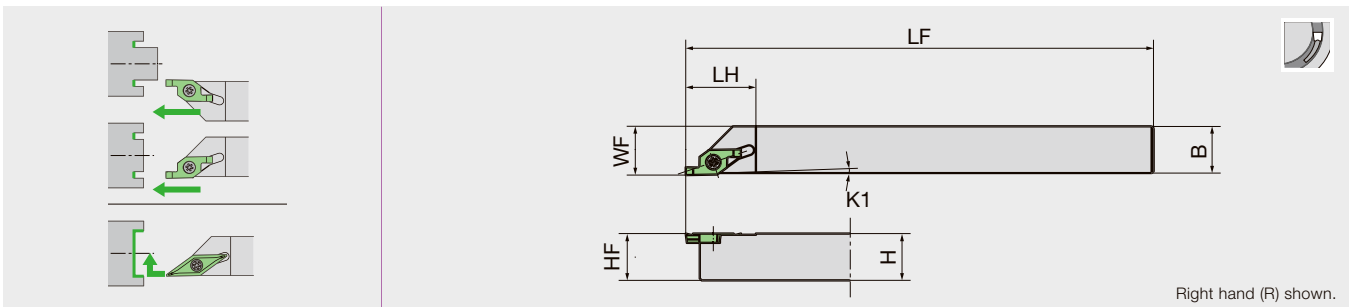

Designation	CW	H	B	LF	LH	K1	WF	Insert
CH-FGVR1010	1 - 2	10	10	120	18	1°	10.5	FGV.. FBV..
CH-FGVR1212	1 - 2	12	12	120	18	1°	12.5	FGV.. FBV..
CH-FGVR1616	1 - 2	16	16	120	18	1°	16.5	FGV.. FBV..
CH-FGVL1010	1 - 2	10	10	120	18	1°	10.5	FGV.. -
CH-FGVL1212	1 - 2	12	12	120	18	1°	12.5	FGV.. -
CH-FGVL1616	1 - 2	16	16	120	18	1°	16.5	FGV.. -

SPARE PARTS



Designation	Clamp screw	Wrench (for Clamp screw)
CH-FGV**	LRIS-2.5*7	CLR-15S

Reference pages: Inserts → 6-75

Grade 1
Insert 2
Ext. Toolholder 3
Int. Toolholder 4
Threading 5
Grooving 6
Shaper 7
Endmill 8
Drilling Tool 9
Technical Reference 10

DS-FGV

DS Toolholders / For sleeve tool post

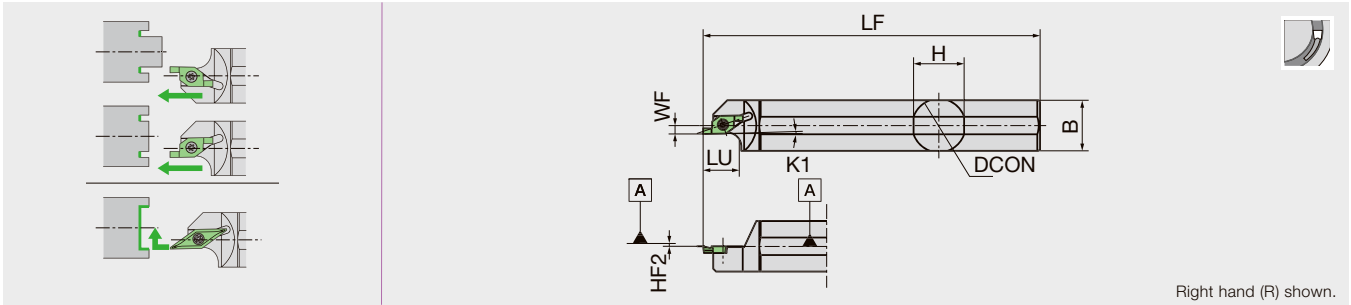

Designation	CW	H	B	LF	DCON	HF2	K1	LU	WF	Insert
DS-FGVR16-012	1 - 2	15	15	80	16	0	1°	11	3	FGV.. FBV..
DS-FGVR19	1 - 2	18	18	120	19.05	0	1°	11	3	FGV.. FBV..
DS-FGVR20	1 - 2	19	19	120	20	0	1°	11	3	FGV.. FBV..
DS-FGVR22	1 - 2	21	21	120	22	0	1°	11	3	FGV.. FBV..
DS-FGVR22M	1 - 2	21	21	150	22	0	1°	11	3	FGV.. FBV..
DS-FGVR25	1 - 2	24.5	24.5	120	25.4	0	1°	11	3	FGV.. FBV..
DS-FGVR25-MET	1 - 2	24	24	150	25	0	1°	11	3	FGV.. FBV..
DS-FGVL16-012	1 - 2	15	15	80	16	0	1°	11	3	FGV.. -
DS-FGVL19	1 - 2	18	18	120	19.05	0	1°	11	3	FGV.. -
DS-FGVL20	1 - 2	19	19	120	20	0	1°	11	3	FGV.. -
DS-FGVL22	1 - 2	21	21	120	22	0	1°	11	3	FGV.. -
DS-FGVL22M	1 - 2	21	21	150	22	0	1°	11	3	FGV.. -
DS-FGVL25	1 - 2	24.5	24.5	120	25.4	0	1°	11	3	FGV.. -
DS-FGVL25-MET	1 - 2	24	24	150	25	0	1°	11	3	FGV.. -

SPARE PARTS



Designation	Clamp screw	Wrench (for Clamp screw)
DS-FGVR/L**	LRIS-2.5*7	CLR-15S

Reference pages: Inserts → [6-75](#)

INSERT

FGV with chipbreaker

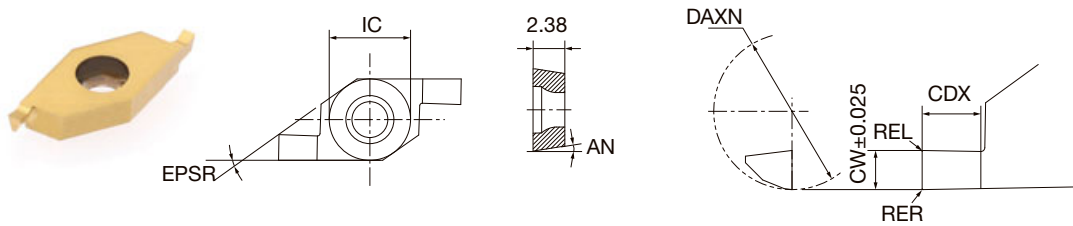

Right hand (R) shown.

P	Steel	★
M	Stainless	★
N	Non-ferrous	☆
S	Superalloys	
H	Hard materials	

★ : First choice
☆ : Second choice

Designation	HAND	Coated	CW	APMX	CDX	DAXN	IC	AN	EPSR	REL	RER
		TM4									
FGV100RB00D6	R	●	1	1.5	1.75	6	6.35	7°	35°	0	0
FGV100RB05D6	R	●	1	1.5	1.8	6	6.35	7°	35°	0.05	0.05
FGV150RB00D6	R	●	1.5	2	2.2	6	6.35	7°	35°	0	0
FGV150RB05D6	R	●	1.5	2	2.3	6	6.35	7°	35°	0.05	0.05
FGV200RB00D6	R	●	2	3	3.2	6	6.35	7°	35°	0	0
FGV200RB05D6	R	●	2	3	3.3	6	6.35	7°	35°	0.05	0.05
FGV100LB00D6	L	●	1	1.5	1.75	6	6.35	7°	35°	0	0
FGV100LB05D6	L	●	1	1.5	1.8	6	6.35	7°	35°	0.05	0.05
FGV150LB00D6	L	●	1.5	2	2.2	6	6.35	7°	35°	0	0
FGV150LB05D6	L	●	1.5	2	2.3	6	6.35	7°	35°	0.05	0.05
FGV200LB00D6	L	●	2	3	3.2	6	6.35	7°	35°	0	0
FGV200LB05D6	L	●	2	3	3.3	6	6.35	7°	35°	0.05	0.05

● : Line up

FBV with chipbreaker

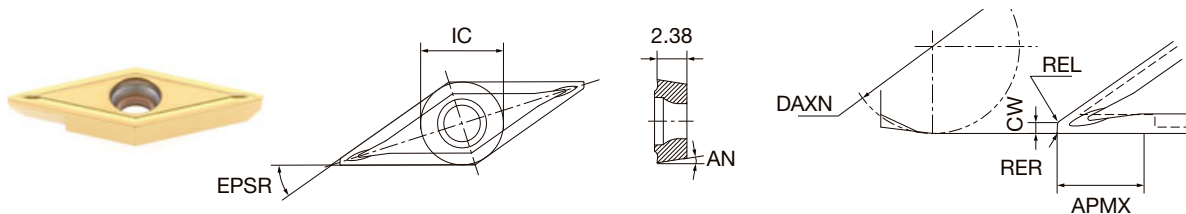

Right hand (R) shown.

P	Steel	★
M	Stainless	★
N	Non-ferrous	☆
S	Superalloys	
H	Hard materials	

★ : First choice
☆ : Second choice

Designation	HAND	Coated	CW	APMX	DAXN	IC	AN	EPSR	REL	RER
		TM4								
FBV40R05D8AM3	R	●	(0.5)	4	8	6.35	7°	35°	0.2	0.05
FBV40R15D8AM3	R	●	(0.5)	4	8	6.35	7°	35°	0.2	0.15

Note: Only CH-FGVR and DS-FGVR can take FBV Right hand insert.

● : Line up

Reference pages: Toolholders → **6-73, 6-74**

Grade 1
Insert 2
Ext. Toolholder 3
Int. Toolholder 4
Threading 5
Grooving 6
Shaper 7
Endmill 8
Drilling Tool 9
Technical Reference 10

Face grooving toolholder with round shank

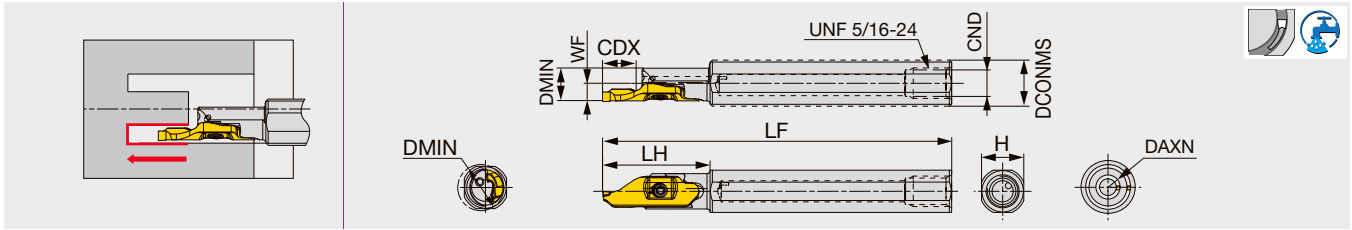

Designation	CDX	DAXN	DCONMS	DMIN	WF	LH	LF	CND	H	Insert	Torque*
A12G-MFR10-D100	9	10	12	10	5	27	90	6.9	11	MFGR10...	1.2
A127G-MFR10-D100	9	10	12.7	10	5	27	90	6.9	11.7	MFGR10...	1.2
A159F-MFR10-D100	9	10	15.875	10	5	27	85	6.9	15	MFGR10...	1.2
A16F-MFR10-D100	9	10	16	10	5	27	85	6.9	15	MFGR10...	1.2

SPARE PARTS

Designation	Clamping screw	Wrench
A***-MFR10...	CSTB-2.5	T-8F

INSERTS

MFGR10

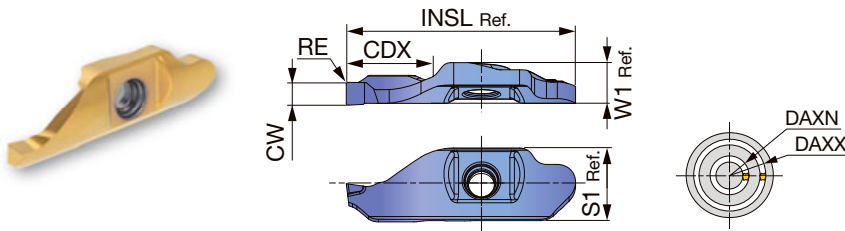

P Steel	★						
M Stainless	★						
K Cast iron							
N Non-ferrous							
S Superalloys							
H Hard materials							

★ : First choice

Designation	CW±0.025	RE	Coated				CDX	DAXN	DAXX	INSL	W1	S1
			SH7025									
MFGR10-200-020	2	0.2	●				9	10	-	25	4.6	7.9
MFGR10-200-100	2	1	●				9	10	-	25	4.6	7.9
MFGR10-250-020	2.5	0.2	●				9	10	16	25	4.6	7.9
MFGR10-250-125	2.5	1.25	●				9	10	-	25	4.6	7.9

● : Line up

STANDARD CUTTING CONDITIONS

ISO	Workpiece material	Grade	Cutting speed V _c (m/min)	Feed: f (mm/rev)
P	Low carbon steel S15C, etc., C15E4, etc.	SH7025	30 - 120	0.01 - 0.07
	Carbon steels, Alloy steel S55C, SCM440, etc., C55, 42CrMoS4, etc.	SH7025	30 - 120	0.01 - 0.07
	Prehardened steel NAK80, PX5, etc.	SH7025	30 - 120	0.01 - 0.07
M	Stainless steel SUS304, etc., X5CrNi18-9, etc.	SH7025	30 - 120	0.01 - 0.07

Parting-off and front turning toolholders

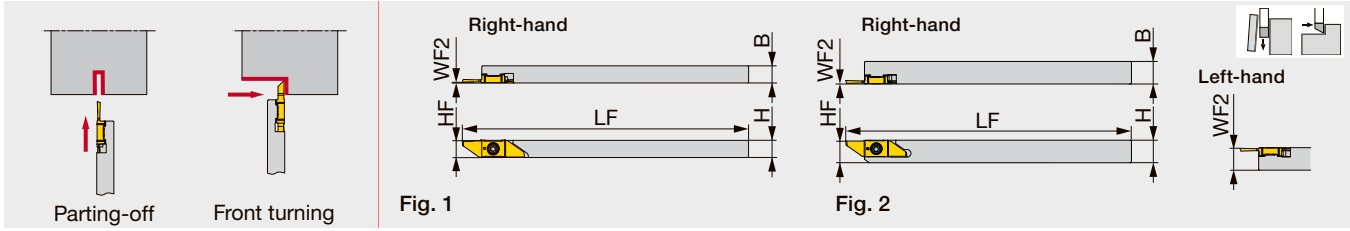

Designation	H	B	LF	HF	WF2 ⁽¹⁾	Insert	Torque*	Fig.
JSXXL0606X05	6	6	120	5.6	5.8	JV*N..., JVN...	1.3	1
JSXXR/L0707X05	7	7	120	6.6	0.2/6.8	JV*N..., JVN...	1.3	1
JSXXR/L0808F05	8	8	85	7.7	0.2/7.8	JV*N..., JVN...	1.3	2
JSXXR/L0808H05	8	8	100	7.7	0.2/7.8	JV*N..., JVN...	1.3	2
JSXXR/L1010H05	10	10	100	9.7	0.2/9.8	JV*N..., JVN...	1.3	2

Torque*: Recommended clamping torque (N·m)

(1) The first value before "/" indicates the WF for the right-hand holder and the second value after "/" for the left-hand holder.

Use the right-hand insert (JV****R...) for a right-hand holder (JSXXR...); the left-hand insert (JV****L...) for a left-hand holder (JSXXL...).

SPARE PARTS

Designation	Clamping screw	Wrench
JSXXR...05	CSTB-2.5L054DL	T-7F
JSXXL...05	CSTB-2.5L054DR	T-7F

INSERTS

JVPN**R/L (For parting-off)

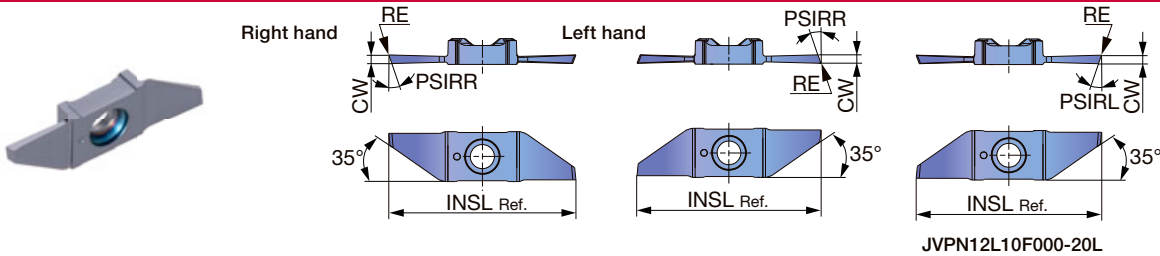

	P	M	K	N	S	H
Steel	★					
Stainless	★					
Cast iron						
Non-ferrous	★					
Superalloys	★					
Hard materials						

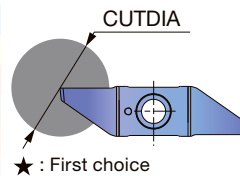

Designation	HAND	CW±0.025	RE	Coated				CUTDIA	INSL	PSIRR	PSIRL
				SH725							
JVPN04R05F000-20	R	0.5	0	●				4	42.8	20°	-
JVPN04L05F000-20	L	0.5	0	●				4	42.8	20°	-
JVPN04R05F005-20	R	0.5	0.05	●				4	42.6	20°	-
JVPN04L05F005-20	L	0.5	0.05	●				4	42.6	20°	-
JVPN07R06F000-20	R	0.6	0	●				7	42.8	20°	-
JVPN07L06F000-20	L	0.6	0	●				7	42.8	20°	-
JVPN07R06F005-20	R	0.6	0.05	●				7	42.8	20°	-
JVPN07L06F005-20	L	0.6	0.05	●				7	42.8	20°	-
JVPN12R08F000-20	R	0.8	0	●				12	43.2	20°	-
JVPN12L08F000-20	L	0.8	0	●				12	43.2	20°	-
JVPN12R08F005-20	R	0.8	0.05	●				12	43	20°	-
JVPN12L08F005-20	L	0.8	0.05	●				12	43	20°	-
JVPN12R10F000-20	R	1	0	●				12	43.4	20°	-
JVPN12L10F000-20	L	1	0	●				12	43.4	20°	-
JVPN12R10F005-20	R	1	0.05	●				12	43.4	20°	-
JVPN12L10F005-20	L	1	0.05	●				12	43.4	20°	-
JVPN12L10F000-20L	L	1	0	●				12	43.4	-	20°

● : Line up

STANDARD CUTTING CONDITIONS

Parting-off

ISO	Workpiece materials	Grade	Cutting speed Vc (m/min)	Feed f (mm/rev)
P	Low carbon steels S15C, SS400, etc. C15E4, E275A, etc.	SH725	50 - 180	0.01 - 0.05
	Carbon steels, Alloy steels S55C, SCM440, etc. C55, 42CrMo4, etc.	SH725	50 - 180	0.01 - 0.05
	Free cutting steels SUH22, SUH23, etc.	SH725	50 - 180	0.01 - 0.05
M	Stainless steels SUS304, X5CrNi18-9, etc.	SH725	50 - 120	0.01 - 0.05
N	Aluminium alloys A5056, A6061, etc.	SH725	150 - 200	0.01 - 0.05
	Copper alloys C2600, C280C, etc.	SH725	100 - 200	0.01 - 0.05
S	Titanium alloys Ti-6Al-4V, etc.	SH725	30 - 80	0.01 - 0.05
	Superalloys Inconel718, etc.	SH725	30 - 80	0.01 - 0.05



CSV

For Cam-style machine

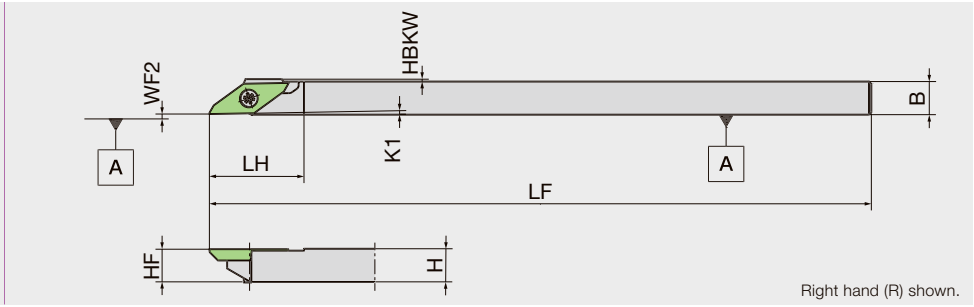

Designation	H	B	LF	LH	HBKW	HF	K1	WF2	Insert
CSVR07	7	7	140	20	0.5	7	1°	0.1	CSV series, CSVF../CSVB../CSVC../CSVG../CSVT..
CSVR07GX	7	7	85	20	0.5	7	1°	0.1	CSV series, CSVF../CSVB../CSVC../CSVG../CSVT..
CSVR08	8	8	140	20	0	8	1°	0.1	CSV series, CSVF../CSVB../CSVC../CSVG../CSVT..
CSVR08GX	8	8	85	20	0	8	1°	0.1	CSV series, CSVF../CSVB../CSVC../CSVG../CSVT..
CSVR095	9.5	9.5	140	20	0	9.5	1°	0.1	CSV series, CSVF../CSVB../CSVC../CSVG../CSVT..
CSVR10	10	10	140	20	0	10	1°	0.1	CSV series, CSVF../CSVB../CSVC../CSVG../CSVT..
CSVR12	12	12	140	20	0	12	1°	0.1	CSV series, CSVF../CSVB../CSVC../CSVG../CSVT..
CSVR12GX	12	12	85	20	0	12	1°	0.1	CSV series, CSVF../CSVB../CSVC../CSVG../CSVT..
CSVL07	7	7	140	20	0.5	7	1°	0.1	CSV series, CSVF../CSVB../CSVC../CSVG../CSVT..
CSVL08	8	8	140	20	0	8	1°	0.1	CSV series, CSVF../CSVB../CSVC../CSVG../CSVT..
CSVL10	10	10	140	20	0	10	1°	0.1	CSV series, CSVF../CSVB../CSVC../CSVG../CSVT..

SPARE PARTS



Designation	Clamp screw	Wrench (for Clamp screw)
CSV**	LRIS-2.5*7	CLR-15S

Reference pages : Inserts → **6-80**

Grade 1
Insert 2
Ext. Toolholder 3
Int. Toolholder 4
Threading 5
Grooving 6
Shaper 7
Endmill 8
Drilling Tool 9
Technical Reference 10

INSERT

CSVC-V without Chipbreaker

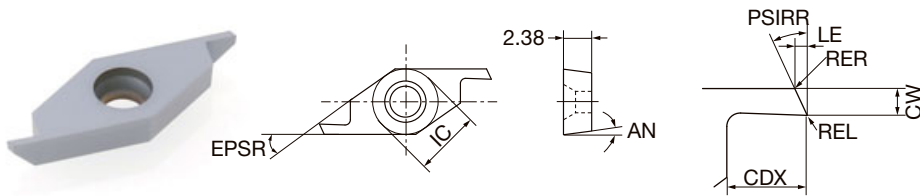

P	Steel	★
M	Stainless	☆
N	Non-ferrous	
S	Superalloys	
H	Hard materials	

★ : First choice
☆ : Second choice

Right hand (R) shown.



Designation	HAND	Coated		CUTDIA	CW	IC	AN	EPSR	CDX	LE	PSIRR	REL	RER
		VM1											
CSVC11FRV06	R	●	M	3	0.6	6.35	7°	35°	2	0.31	25°	0	0
CSVC11FRV07	R	●	M	4	0.7	6.35	7°	35°	2.5	0.36	25°	0	0
CSVC11FRV08	R	●	M	4	0.8	6.35	7°	35°	2.5	0.41	25°	0	0
CSVC11FRV09	R	●	M	4	0.9	6.35	7°	35°	2.5	0.46	25°	0	0
CSVC11FRV10	R	●	M	5	1	6.35	7°	35°	3	0.51	25°	0	0
CSVC11FRV13	R	●	M	5	1.3	6.35	7°	35°	3	0.65	25°	0	0
CSVC11FRV15	R	●	M	5	1.5	6.35	7°	35°	3	0.74	25°	0	0
CSVC11FLV07	L	●	M	4	0.7	6.35	7°	35°	2.5	0.36	25°	0	0
CSVC11FLV08	L	●	M	4	0.8	6.35	7°	35°	2.5	0.41	25°	0	0
CSVC11FLV10	L	●	M	5	1	6.35	7°	35°	3	0.51	25°	0	0
CSVC11FLV13	L	●	M	5	1.3	6.35	7°	35°	3	0.65	25°	0	0
CSVC11FLV15	L	●	M	5	1.5	6.35	7°	35°	3	0.74	25°	0	0

All angles shown are obtained when insert is set in the holder.

● : Line up

CSVC-VB with Chipbreaker

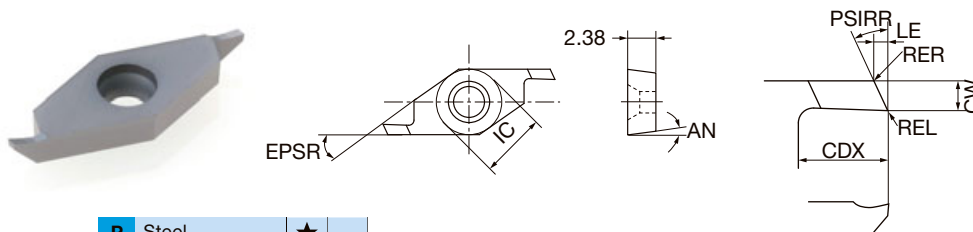

P	Steel	★
M	Stainless	☆
N	Non-ferrous	
S	Superalloys	
H	Hard materials	

★ : First choice
☆ : Second choice

Right hand (R) shown.

Designation	HAND	Coated		CUTDIA	CW	IC	AN	EPSR	CDX	LE	PSIRR	REL	RER
		VM1											
CSVC11FRVB06	R	●	M	3	0.6	6.35	7°	35°	2	0.31	25	0	0
CSVC11FRVB07	R	●	M	4	0.7	6.35	7°	35°	2.5	0.36	25	0	0
CSVC11FRVB08	R	●	M	4	0.8	6.35	7°	35°	2.5	0.41	25	0	0
CSVC11FRVB09	R	●	M	4	0.9	6.35	7°	35°	2.5	0.46	25	0	0
CSVC11FRVB10	R	●	M	5	1	6.35	7°	35°	3	0.51	25	0	0
CSVC11FRVB13	R	●	M	5	1.3	6.35	7°	35°	3	0.65	25	0	0
CSVC11FRVB15	R	●	M	5	1.5	6.35	7°	35°	3	0.74	25	0	0

All angles shown are obtained when insert is set in the holder.

● : Line up

CTP.. series/Toolholder

CTPR-SUB-OH3

Coolant through (direct connect compatible) for Sub-Spindle

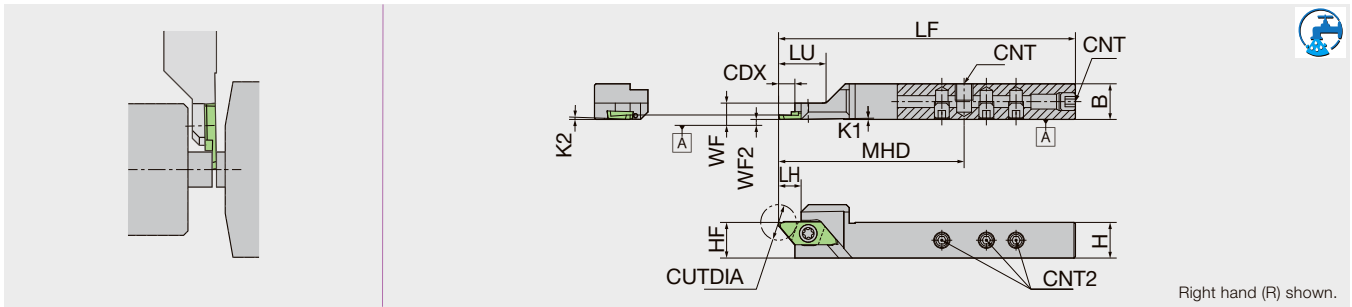

Designation	CUTDIA	H	B	LF	LH	CDX	HF	K1	K2	LU	MHD	WF	WF2	CNT	CNT2	Insert
CTPR12H-SUB-OH3	12	12	12	100	7.6	5.5	12	1°	2°	16	62.5	5.5	0	M6*1	M5	CTP..

NOTE: Reference Chart of OH3 Hole Position → 10-1

SPARE PARTS

Designation	Clamp screw	Wrench (for Clamp screw)
CTPR12H-SUB-OH3	LRIS-4*5	LLR-25S

CTPL-SUB-OH3

Coolant through (direct connect compatible) for Sub-spindle

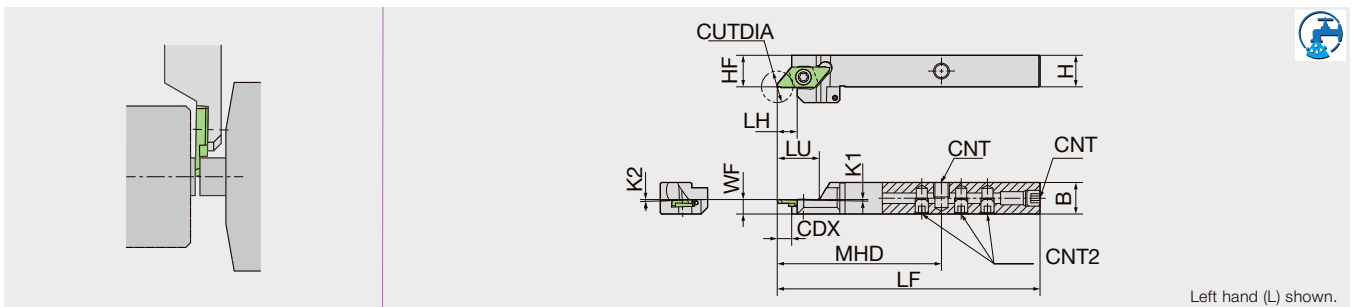

Designation	CUTDIA	H	B	LF	LH	CDX	HF	K1	K2	LU	MHD	WF	WF2	CNT	CNT2	Insert
CTPL12H-SUB-OH3	12	12	12	100	7.6	5.5	12	1°	2°	16	62.5	5.5	0	M6*1	M5	CTP..

NOTE: Reference Chart of OH3 Hole Position → 10-1

SPARE PARTS

Designation	Clamp screw	Wrench (for Clamp screw)
CTPL12H-SUB-OH3	LRIS-4*5	LLR-25S

CTP-OH2

Coolant through (direct connect compatible)

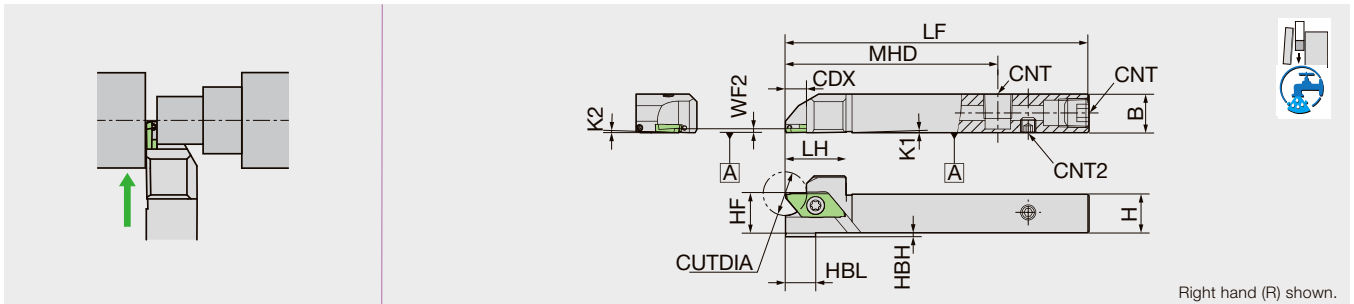

Designation	CUTDIA	H	B	LF	LH	CDX	HBH	HBL	HF	K1	K2	MHD	WF2	CNT	CNT2	Insert
CTPR12H-OH2	12	12	12	100	19.5	7	2	10	12	1°	2°	70	1.5	Rc1/8	M5	CTP..
CTPL12H-OH2	12	12	12	100	19.5	7	2	10	12	1°	2°	70	1.5	Rc1/8	M5	CTP..

SPARE PARTS

Designation	Clamp screw	Screw (for CNT)	Screw (for CNT2)	Wrench (for Clamp screw)	Wrench (for CNT2)
CTPR/L12H-OH2	LRIS-4*12PW	SPR1/8	SS0505SC	CLR-15S	LW-2.5

CTP-OH

Coolant through

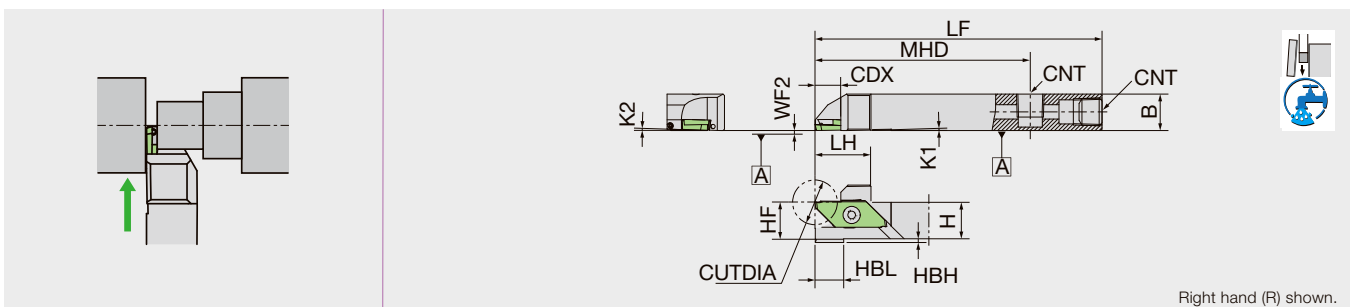

Designation	CUTDIA	H	B	LF	LH	CDX	HBH	HBL	HF	K1	K2	MHD	WF2	CNT	Insert
CTPR1012H-OH	12	10	12	100	19.5	7	4	19	10	1°	2°	75	0	M6*1	CTP..
CTPR12H-OH	12	12	12	100	19.5	7	2	10	12	1°	2°	75	0	Rc1/8	CTP..
CTPR16H-OH	12	16	16	100	19.5	7	-	-	16	1°	2°	75	0	Rc1/8	CTP..
CTPL1012H-OH	12	10	12	100	19.5	7	4	19	10	1°	2°	75	0	M6*1	CTP..
CTPL12H-OH	12	12	12	100	19.5	7	2	10	12	1°	2°	75	0	Rc1/8	CTP..
CTPL16H-OH	12	16	16	100	19.5	7	-	-	16	1°	2°	75	0	Rc1/8	CTP..

SPARE PARTS

Designation	Clamp screw	Screw (for CNT)	Wrench (for Clamp screw)	Wrench (for CNT)
CTPR/L1012H-OH	LRIS-4*12PW	SS0605SC	CLR-15S	LW-3
CTPR/L12H-OH	LRIS-4*12PW	SPR1/8	CLR-15S	-
CTPR/L16H-OH	LRIS-4*12PW	SPR1/8	CLR-15S	-

Reference pages : Inserts → 6-85 - 6-90

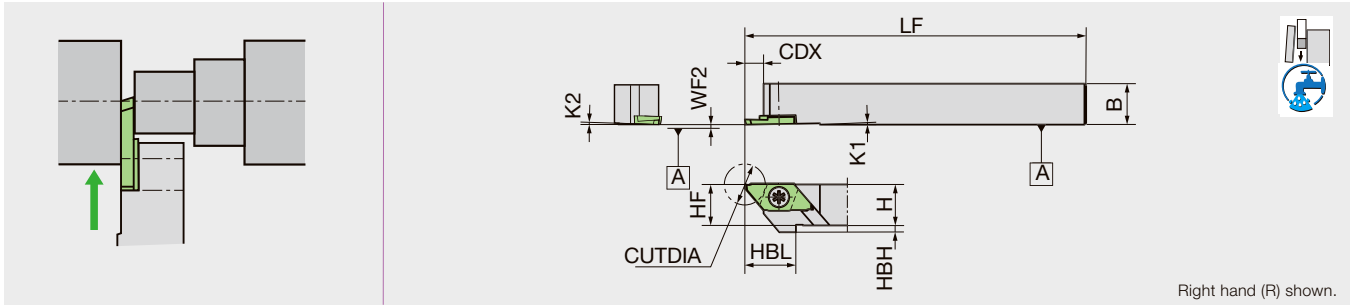

Designation	CUTDIA	H	B	LF	CDX	HBH	HBL	HF	K1	K2	WF2	Insert
CTPR08	12	8	10	120	5.5	4	15	8	1°	2°	0	CTP..
CTPR10	12	10	10	120	5.5	2	15	10	1°	2°	0	CTP..
CTPR10H	12	10	10	100	5.5	2	15	10	1°	2°	0	CTP..
CTPR12	12	12	12	120	5.5	-	-	12	1°	2°	0	CTP..
CTPR12GX	12	12	12	85	5.5	-	-	12	1°	2°	0	CTP..
CTPR16	12	16	16	120	5.5	-	-	16	1°	2°	0	CTP..
CTPR16H	12	16	16	100	5.5	-	-	16	1°	2°	0	CTP..
CTPL08	12	8	10	120	5.5	4	15	8	1°	2°	0	CTP..
CTPL10	12	10	10	120	5.5	2	15	10	1°	2°	0	CTP..
CTPL10H	12	10	10	100	5.5	2	15	10	1°	2°	0	CTP..
CTPL12	12	12	12	120	5.5	-	-	12	1°	2°	0	CTP..
CTPL12GX	12	12	12	85	5.5	-	-	12	1°	2°	0	CTP..
CTPL16	12	16	16	120	5.5	-	-	16	1°	2°	0	CTP..

SPARE PARTS



Designation	Clamp screw	Wrench (for Clamp screw)
CTPR/L08	LRIS-4*10PW	CLR-15S
CTPR/L10**	LRIS-4*10PW	CLR-15S
CTPR/L12**	LRIS-4*12PW	CLR-15S
CTPR/L16**	LRIS-4*12PW	CLR-15S

CTPR-SUB

For Sub-Spindle

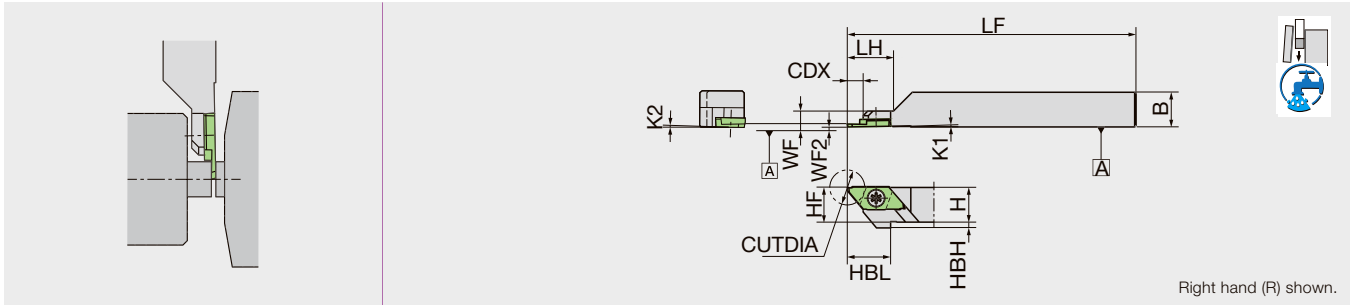

Right hand (R) shown.

Designation	CUTDIA	H	B	LF	LH	CDX	HBH	HBL	HF	K1	K2	WF	WF2	Insert
CTPR08J-SUB	12	8	8	110	16	5.5	4	15	8	1°	2°	5.5	0	CTP..
CTPR08-SUB	12	8	8	120	16	5.5	4	15	8	1°	2°	5.5	0	CTP..
CTPR10F-SUB	12	10	10	80	16	5.5	2	15	10	1°	2°	5.5	0	CTP..
CTPR10KX-SUB	12	10	10	120	16	5.5	2	15	10	1°	2°	5.5	0	CTP..
CTPR12GX-SUB	12	12	12	85	16	5.5	-	-	12	1°	2°	5.5	0	CTP..
CTPR12-SUB	12	12	12	120	16	5.5	-	-	12	1°	2°	5.5	0	CTP..

SPARE PARTS



Designation	Clamp screw	Wrench (for Clamp screw)
CTPR*-SUB	LRIS-4*5	LLR-25S

CTPL-SUB

For Sub-Spindle

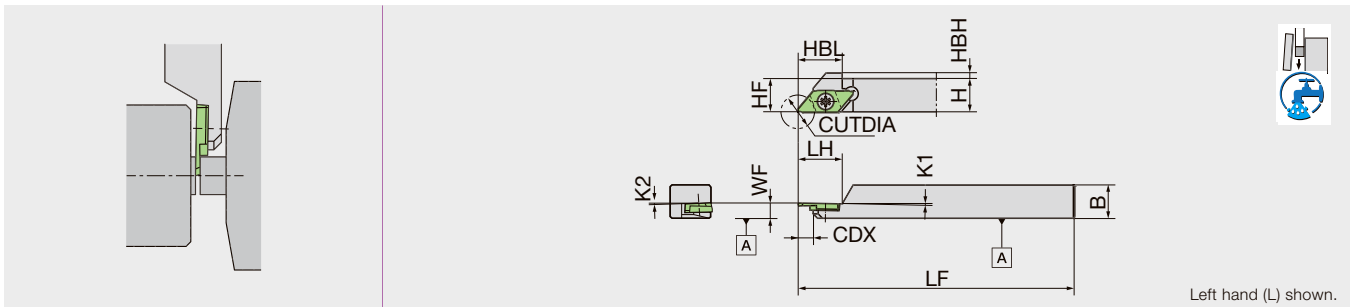

Left hand (L) shown.

Designation	CUTDIA	H	B	LF	LH	CDX	HBH	HBL	HF	K1	K2	WF	WF2	Insert
CTPL08J-SUB	12	8	8	110	16	5.5	4	15	8	1°	2°	5.5	CTP..	CTP..
CTPL08-SUB	12	8	8	120	16	5.5	4	15	8	1°	2°	5.5	CTP..	CTP..
CTPL10GX-SUB	12	10	10	85	16	5.5	2	15	10	1°	2°	5.5	CTP..	CTP..
CTPL12GX-SUB	12	12	12	85	16	5.5	-	-	12	1°	2°	5.5	CTP..	CTP..

SPARE PARTS



Designation	Clamp screw	Wrench (for Clamp screw)
CTPL*-SUB	LRIS-4*5	LLR-25S

Reference pages : Inserts → [6-85](#) - [6-90](#)

INSERT
CTP-FR

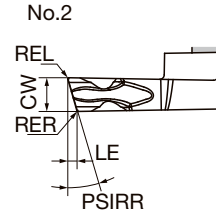
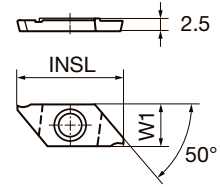
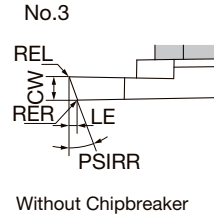
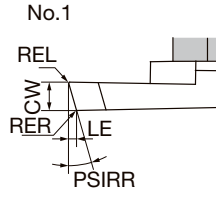
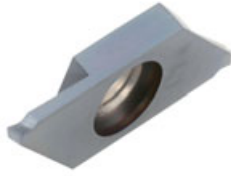

P Steel	☆	☆	★		★	☆		
M Stainless	★	☆	☆	★		☆		
N Non-ferrous						☆	★	
S Superalloys	★	☆	☆					
H Hard materials	☆		★					

★ : First choice
☆ : Second choice

Designation	HAND	Coated						Uncoated	CUTDIA	CW	INSL	W1	LE	PSIRR	REL	RER	Figure	
		DM4	DT4	QM3	ST4	VM1	ZM3											KM1
CTP05FR-SH	R								5	0.5	20	8	0.17	16°	0.05	0.05	1	
CTP07FR	R								8	0.7	20	8	0.23	16°	0.05	0.05	1	
CTP10FR	R		●						12	1	20	8	0.32	16°	0.05	0.05	1	
CTP10FR-CX	R	●			●				12	1	20	8	0.32	16°	0.05	0.05	2	
CTP10FR-SH	R		●						7	1	20	8	0.32	16°	0.05	0.05	1	
CTP10FR-TH	R				●				12	1	20	8	0.32	16°	0.05	0.05	1	
CTP10FRV	R		●			●	●	Ⓜ	12	1	20	8	0.4	20°	0	-	3	
CTP13FR	R		●				●		12	1.3	20	8	0.4	16°	0.05	0.05	1	
CTP13FR-CX	R	●			●				12	1.3	20	8	0.4	16°	0.05	0.05	2	
CTP15FR	R					●	●		12	1.5	20	8	0.46	16°	0.05	0.05	1	
CTP15FR-CX	R	●			●				12	1.5	20	8	0.46	16°	0.05	0.05	2	
CTP15FR-TH	R				●				12	1.5	20	8	0.46	16°	0.05	0.05	1	
CTP15FRV	R					●	●	●	Ⓜ	12	1.5	20	8	0.58	20°	0	-	3
CTP15FRX	R						●		12	1.5	20	8	0.46	16°	0.05	0.05	1	
CTP20FR	R					●	●		12	2	20	8	0.61	16°	0.05	0.05	1	
CTP20FR-TH	R				●				12	2	20	8	0.61	16°	0.05	0.05	1	
CTP20FRV	R					●	●	●	Ⓜ	12	2	20	8	0.77	20°	0	-	3
CTP20FRX	R						●		12	2	20	8	0.61	16°	0.05	0.05	1	
CTPX15FR	R		●	●			●		12	1.5	20	8	0.46	16°	0.05	0.05	1	
CTPX20FR	R		●	●			●		12	2	20	8	0.61	16°	0.05	0.05	1	

NOTE: All angles shown are obtained when insert is set in the holder.

● : Line up

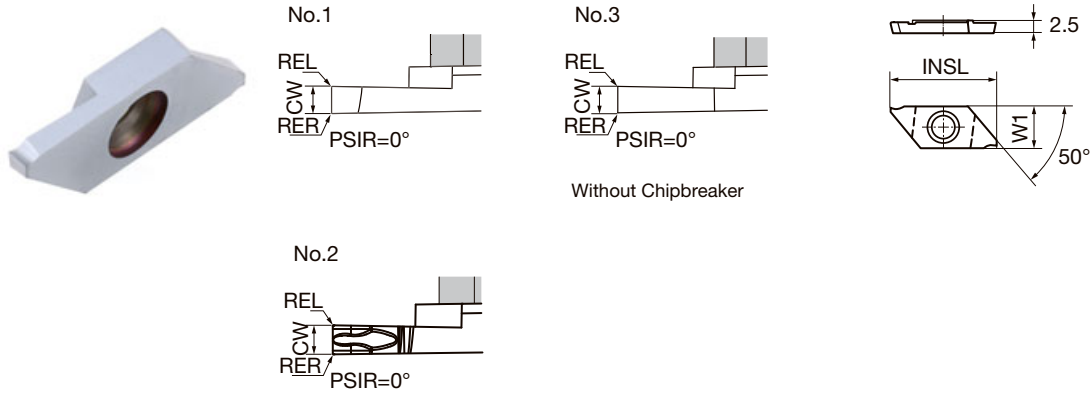

P	Steel	☆	☆	★		★	☆		
M	Stainless	★	☆	☆	★		☆		
N	Non-ferrous						☆	★	
S	Superalloys	★	☆	☆					
H	Hard materials	☆		★					

★ : First choice
☆ : Second choice

Designation	HAND	Coated						Uncoated	CUTDIA	CW	INSL	W1	PSIR	REL	RER	Figure
		DM4	DT4	QM3	ST4	VM1	ZM3									
CTP05FRN-SH	R						●		5	0.5	20	8	0°	0.05	0.05	1
CTP10FRN	R		●				●		12	1	20	8	0°	0.05	0.05	1
CTP10FRN-CX	R	●			●				12	1	20	8	0°	0.05	0.05	2
CTP10FRN-SH	R		●				●		7	1	20	8	0°	0.05	0.05	1
CTP10FRN-TH	R				●				12	1	20	8	0°	0.05	0.05	1
CTP13FRN	R		●				●		12	1.3	20	8	0°	0.05	0.05	1
CTP13FRN02-CX	R	●			●				12	1.3	20	8	0°	0.2	0.2	2
CTP13FRN-CX	R	●			●				12	1.3	20	8	0°	0.05	0.05	2
CTP15FRN	R					●	●		12	1.5	20	8	0°	0.05	0.05	1
CTP15FRN02-CX	R	●			●				12	1.5	20	8	0°	0.2	0.2	2
CTP15FRN-CX	R	●			●				12	1.5	20	8	0°	0.05	0.05	2
CTP15FRN-TH	R				●				12	1.5	20	8	0°	0.05	0.05	1
CTP15FRNV	R						●	Ⓜ	12	1.5	20	8	0°	0	0	3
CTP15FRNX	R						●		12	1.5	20	8	0°	0.05	0.05	1
CTP20FRN	R					●	●		12	2	20	8	0°	0.05	0.05	1
CTP20FRN-TH	R				●				12	2	20	8	0°	0.05	0.05	1
CTP20FRNV	R						●	Ⓜ	12	2	20	8	0°	0	0	3
CTP20FRNX	R						●		12	2	20	8	0°	0.05	0.05	1
CTPX15FRN	R		●	●					12	1.5	20	8	0°	0.05	0.05	1
CTPX20FRN	R		●	●					12	2	20	8	0°	0.05	0.05	1

NOTE: All angles shown are obtained when insert is set in the holder.

● : Line up

CTP-FRK with Chipbreaker

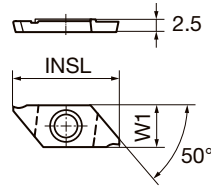
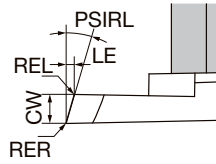
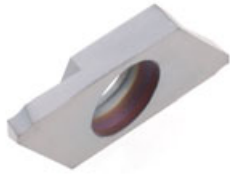

P	Steel	★	★
M	Stainless	★	☆
N	Non-ferrous	★	★
S	Superalloys	★	
H	Hard materials	★	

★ : First choice
☆ : Second choice

Designation	HAND	Coated		CUTDIA	CW	INSL	W1	LE	PSIRR	REL	RER	Figure
		DT4	ZM3									
CTP10FRK	R		●	11	1	20	8	0.32	16°	0.05	0.05	1
CTP13FRK	R	●	●	12	1.3	20	8	0.4	16°	0.05	0.05	1
CTP15FRK	R		●	11	1.5	20	8	0.46	16°	0.05	0.05	1
CTP20FRK	R		●	11	2	20	8	0.61	16°	0.05	0.05	2

NOTE: All angles shown are obtained when insert is set in the holder.

● : Line up

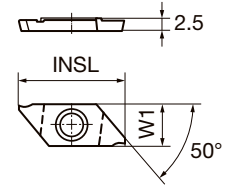
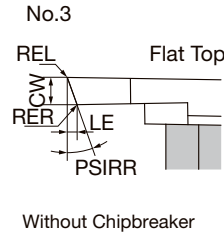
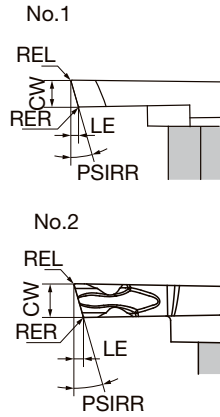
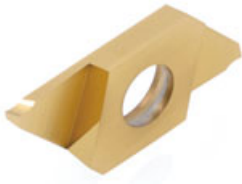

P	Steel	☆	☆	★	★	☆	
M	Stainless	★	☆	☆	★	☆	
N	Non-ferrous					☆	★
S	Superalloys	★	☆	☆			
H	Hard materials	☆		★			

★ : First choice
☆ : Second choice

Designation	HAND	Coated						Uncoated	CUTDIA	CW	INSL	W1	LE	PSIRR	REL	RER	Figure
		DM4	DT4	QM3	ST4	VM1	ZM3	KM1									
CTP05FLK-SH	L						●		5	0.5	20	8	0.17	16°	0.05	0.05	1
CTP10FLK	L		●				●		11	1	20	8	0.32	16°	0.05	0.05	1
CTP10FLK-CX	L	●			●				11	1	20	8	0.32	16°	0.05	0.05	2
CTP10FLK-SH	L		●				●		7	1	20	8	0.32	16°	0.05	0.05	1
CTP10FLK-TH	L				●				11	1	20	8	0.32	16°	0.05	0.05	1
CTP13FLK	L		●				●		11	1.3	20	8	0.4	16°	0.05	0.05	1
CTP13FLK-CX	L	●			●				11	1.3	20	8	0.4	16°	0.05	0.05	2
CTP15FLK	L					●	●		11	1.5	20	8	0.46	16°	0.05	0.05	1
CTP15FLKB	L						●		11	1.5	20	8	0.46	16°	0.05	0.05	1
CTP15FLK-CX	L	●			●				11	1.5	20	8	0.46	16°	0.05	0.05	2
CTP15FLK-TH	L				●				11	1.5	20	8	0.46	16°	0.05	0.05	1
CTP15FLKV	L					●	●	Ⓜ	11	1.5	20	8	0.58	20°	0	0	3
CTP20FLK	L					●	●		11	2	20	8	0.61	16°	0.05	0.05	1
CTP20FLK-TH	L				●				11	2	20	8	0.61	16°	0.05	0.05	1
CTP20FLKV	L					●		Ⓜ	11	2	20	8	0.77	20°	0	0	3
CTPX15FLK	L		●	●					11	1.5	20	8	0.46	16°	0.05	0.05	1
CTPX20FLK	L		●	●					11	2	20	8	0.61	16°	0.05	0.05	1

NOTE: All angles shown are obtained when insert is set in the holder.

● : Line up

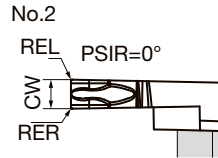
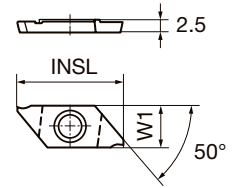
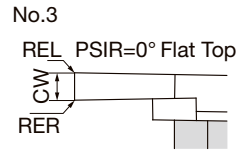
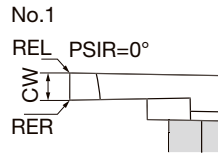

Without Chipbreaker

P Steel	☆	☆	★		★	☆		
M Stainless	★	☆	☆	★		☆		
N Non-ferrous						☆	★	
S Superalloys	★	☆	☆					
H Hard materials	☆		★					

★ : First choice
☆ : Second choice

Designation	HAND	Coated						Uncoated	CUTDIA	CW	INSL	W1	REL	RER	Figure
		DM4	DT4	QM3	ST4	VM1	ZM3	KM1							
CTP05FLN-SH	L								5	0.5	20	8	0.05	0.05	1
CTP10FLN	L		●						12	1	20	8	0.05	0.05	1
CTP10FLN-CX	L	●			●				12	1	20	8	0.05	0.05	2
CTP10FLN-SH	L		●						7	1	20	8	0.05	0.05	1
CTP10FLN-TH	L				●				12	1	20	8	0.05	0.05	1
CTP13FLN	L		●						12	1.3	20	8	0.05	0.05	1
CTP13FLN02-CX	L	●			●				12	1.3	20	8	0.2	0.2	2
CTP13FLN-CX	L	●			●				12	1.3	20	8	0.05	0.05	2
CTP15FLN	L					●	●		12	1.5	20	8	0.05	0.05	1
CTP15FLN02-CX	L	●			●				12	1.5	20	8	0.2	0.2	2
CTP15FLN-CX	L	●			●				12	1.5	20	8	0.05	0.05	2
CTP15FLN-TH	L				●				12	1.5	20	8	0.05	0.05	1
CTP15FLNV	L						●	Ⓜ	12	1.5	20	8	0	0	3
CTP20FLN	L					●	●		12	2	20	8	0.05	0.05	1
CTP20FLN-TH	L				●				12	2	20	8	0.05	0.05	1
CTP20FLNV	L						●	Ⓜ	12	2	20	8	0	0	3
CTPX15FLN	L		●	●					12	1.5	20	8	0.05	0.05	1
CTPX20FLN	L		●	●					12	2	20	8	0.05	0.05	1

NOTE: All angles shown are obtained when insert is set in the holder.

● : Line up

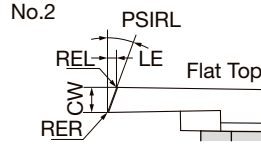
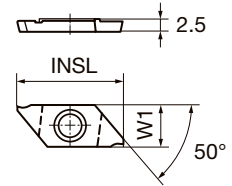
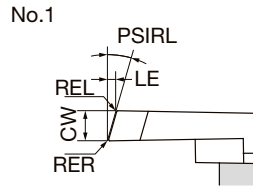

Without Chipbreaker

P	Steel	☆	★	★
M	Stainless	★	☆	☆
N	Non-ferrous	☆	☆	★
S	Superalloys	★	☆	☆
H	Hard materials	☆	☆	☆

★ : First choice
☆ : Second choice

Designation	HAND	Coated			CUTDIA	CW	INSL	W1	LE	PSIRL	REL	RER	Figure
		DT4	VM1	ZM3									
CTP07FL	L			●	8	0.7	20	8	0.23	16°	0.05	0.05	1
CTP10FL	L			●	12	1	20	8	0.32	16°	0.05	0.05	1
CTP10FLV	L		●	●	12	1	20	8	0.4	20°	0	0	2
CTP13FL	L	●		●	12	1.3	20	8	0.4	16°	0.05	0.05	1
CTP15FL	L			●	12	1.5	20	8	0.46	16°	0.05	0.05	1
CTP15FLV	L		●	●	12	1.5	20	8	0.58	20°	0	0	2
CTP20FL	L			●	12	2	20	8	0.61	16°	0.05	0.05	1
CTP20FLV	L		●	●	12	2	20	8	0.77	20°	0	0	2
CTPX15FL	L	●			12	1.5	20	8	0.46	16°	0.05	0.05	1
CTPX20FL	L	●			12	2	20	8	0.61	16°	0.05	0.05	1

NOTE: All angles shown are obtained when insert is set in the holder.

● : Line up

CTPA-OH2

Coolant through (direct connect compatible)

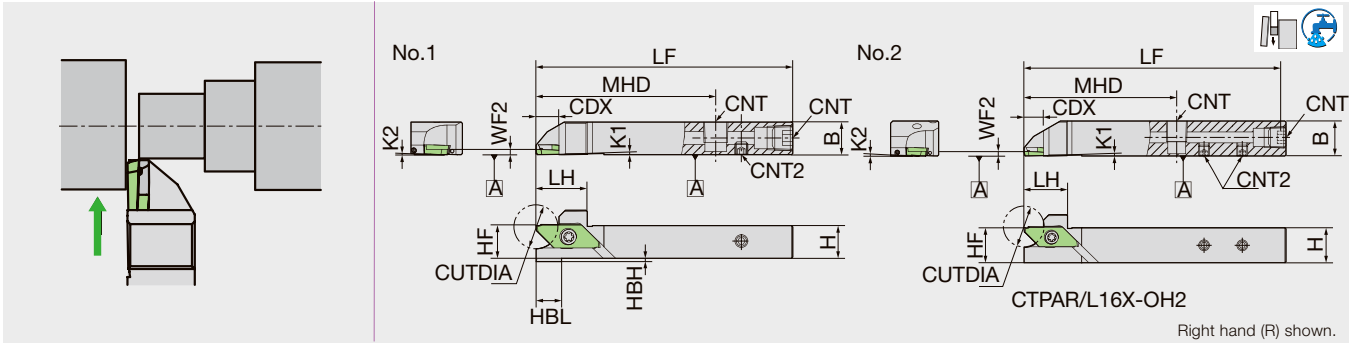

Designation	CUTDIA	H	B	LF	LH	CDX	HBH	HBL	HF	K1	K2	MHD	WF2	CNT	CNT2	Insert	Figure
CTPAR12H-OH2	16	12	12	100	19.5	9	2	10	12	1°	2°	70	2	Rc1/8	M5	CTPA.. TBPA..	1
CTPAR16X-OH2	16	16	16	120	19.5	9	-	-	16	1°	2°	70	2	Rc1/8	M5	CTPA.. TBPA..	2
CTPAL12H-OH2	16	12	12	100	19.5	9	10	10	12	1°	2°	70	2	Rc1/8	M5	CTPA.. TBPA..	1
CTPAL16X-OH2	16	16	16	120	19.5	9	-	-	16	1°	2°	70	2	Rc1/8	M5	CTPA.. TBPA..	2

SPARE PARTS

Designation	Clamp screw	Screw (for CNT)	Screw (for CNT2)	Wrench (for Clamp screw)	Wrench (for CNT2)
CTPAR**-OH2	LRIS-4*12PW	SPR1/8	SS0505SC	CLR-15S	LW-2.5

Grade 1
Insert 2
Ext. Toolholder 3
Int. Toolholder 4
Threading 5
Grooving 6
Shaper 7
Endmill 8
Drilling Tool 9
Technical Reference 10

CTPA

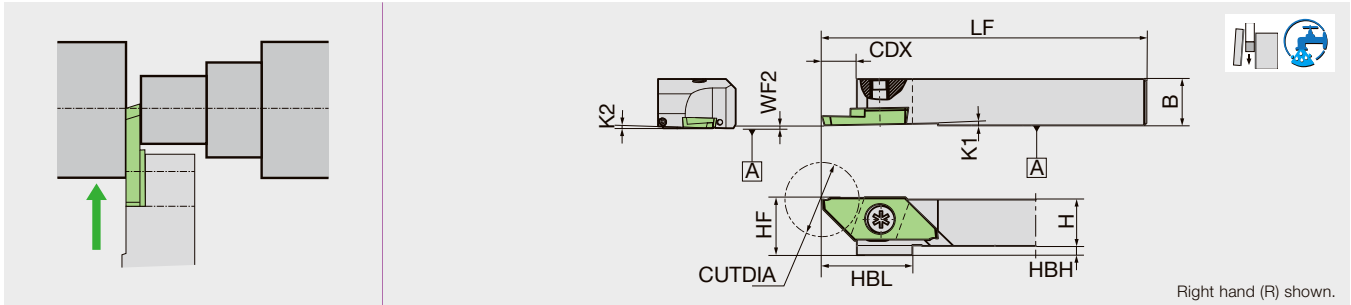

Designation	CUTDIA	H	B	LF	CDX	HBH	HBL	HF	K1	K2	WF2	Insert	
CTPAR10	16	10	10	120	7.5	2	19.5	10	1°	2°	0	CTPA..	TBPA..
CTPAR12	16	12	12	120	7.5	-	-	12	1°	2°	0	CTPA..	TBPA..
CTPAR12GX	16	12	12	85	7.5	-	-	12	1°	2°	0	CTPA..	TBPA..
CTPAR16	16	16	16	120	7.5	-	-	16	1°	2°	0	CTPA..	TBPA..
CTPAR20F	16	20	20	80	7.5	-	-	20	1°	2°	0	CTPA..	TBPA..
CTPAL10	16	10	10	120	7.5	2	19.5	10	1°	2°	0	CTPA..	TBPA..
CTPAL12	16	12	12	120	7.5	-	-	12	1°	2°	0	CTPA..	TBPA..
CTPAL12GX	16	12	12	85	7.5	-	-	12	1°	2°	0	CTPA..	TBPA..
CTPAL16	16	16	16	120	7.5	-	-	16	1°	2°	0	CTPA..	TBPA..
CTPAL20F	16	20	20	80	7.5	-	-	20	1°	2°	0	CTPA..	TBPA..

SPARE PARTS

Designation	Clamp screw	Wrench (for Clamp screw)
CTPAR/L10	LRIS-4*10PW	CLR-15S
CTPAR/L12**	LRIS-4*12PW	CLR-15S
CTPAR/L16	LRIS-4*12PW	CLR-15S
CTPAR/L20F	LRIS-4*10	LLR-25S

CTPAR-SUB

For Sub-Spindle

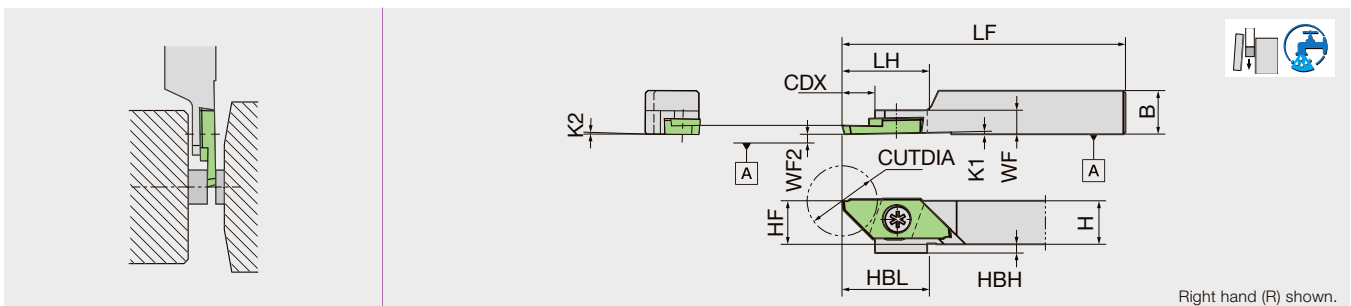

Designation	CUTDIA	H	B	LF	LH	CDX	HBH	HBL	HF	K1	K2	MHD	WF2	Insert
CTPAR10GX-SUB	16	10	10	85	20	7.5	2	19.5	10	1°	2°	5.5	0	CTPA..
CTPAR12GX-SUB	16	12	12	85	20	7.5	-	-	12	1°	2°	5.5	0	CTPA..
CTPAR12KX-SUB	16	12	12	120	20	7.5	-	-	12	1°	2°	5.5	0	CTPA..

SPARE PARTS

Designation	Clamp screw	Wrench (for Clamp screw)
CTPAR**-SUB	LRIS-4*5	LLR-25S

Reference pages : Inserts → [6-93](#) - [6-96](#)

CTPAL-SUB

For Sub-Spindle

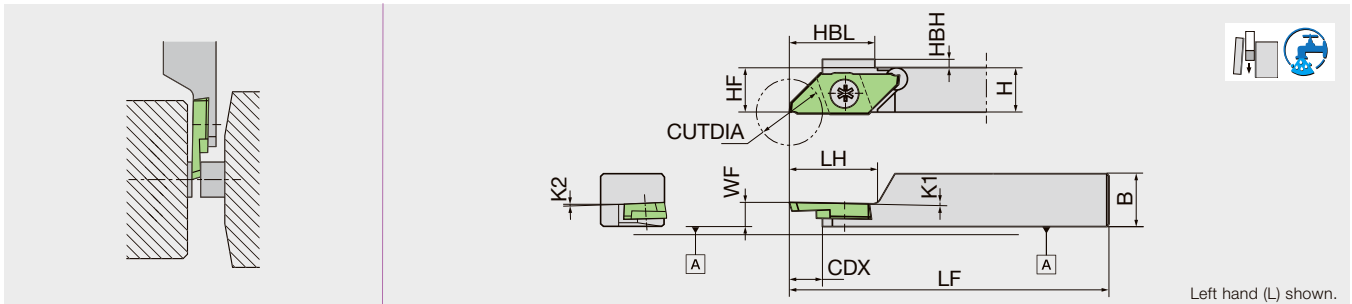

Designation	CUTDIA	H	B	LF	LH	CDX	HBH	HBL	HF	K1	K2	WF	Insert
CTPAL10GX-SUB	16	10	10	85	20	7.5	2	19.5	10	1°	2°	5.5	CTPA..
CTPAL12GX-SUB	16	12	12	85	20	7.5	-	-	12	1°	2°	5.5	CTPA..
CTPAL12KX-SUB	16	12	12	120	20	7.5	-	-	12	1°	2°	5.5	CTPA..
CTPAL16GX-SUB	16	16	16	85	28	7.5	-	-	16	1°	2°	5.5	CTPA..
CTPAL16KX-SUB	16	16	16	120	28	7.5	-	-	16	1°	2°	5.5	CTPA..

SPARE PARTS



Designation	Clamp screw	Wrench (for Clamp screw)
CTPAL*-SUB	LRIS-4*5	LLR-25S

INSERT

CTPA-FR

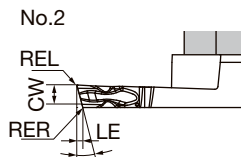
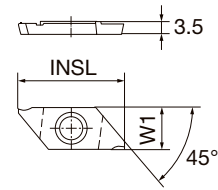
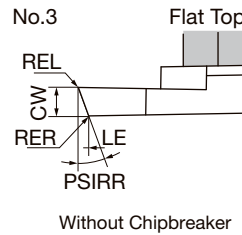
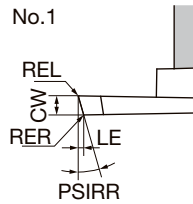
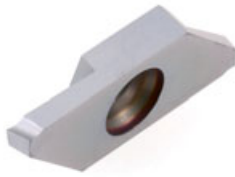

P Steel	☆	☆	★	☆	☆	☆	☆
M Stainless	★	☆	☆	★	☆	☆	☆
N Non-ferrous	☆	☆	☆	☆	☆	☆	★
S Superalloys	★	☆	☆	☆	☆	☆	☆
H Hard materials	☆	☆	★	☆	☆	☆	☆

★ : First choice
☆ : Second choice

Designation	HAND	Coated						Uncoated	CUTDIA	CW	INSL	W1	LE	PSIRR	REL	RER	Figure
		DM4	DT4	QM3	ST4	VM1	ZM3	KM1									
CTPA07FR	R								8	0.7	25	9.4	0.23	16°	0.05	0.05	1
CTPA10FR	R								12	1	25	9.4	0.32	16°	0.05	0.05	1
CTPA15FR	R		●	●		●	●		16	1.5	25	9.4	0.46	16°	0.05	0.05	1
CTPA15FR-CX	R	●			●				16	1.5	25	9.4	0.46	16°	0.05	0.05	2
CTPA15FR-TH	R				●				16	1.5	25	9.4	0.46	16°	0.05	0.05	1
CTPA20FR	R		●	●		●	●		16	2	25	9.4	0.61	16°	0.05	0.05	1
CTPA20FR-TH	R				●				16	2	25	9.4	0.61	16°	0.05	0.05	1
CTPA20FRV	R					●	●	Ⓜ	16	2	25	9.4	0.77	20°	0	0	3

NOTE: All angles shown are obtained when insert is set in the holder.

● : Line up

Reference pages : Toolholders → 6-91 - 6-93

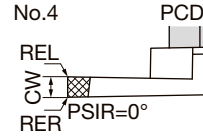
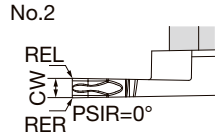
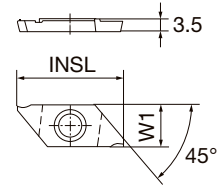
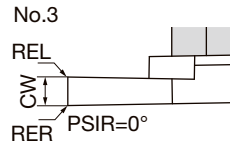
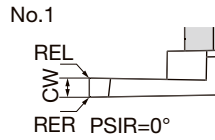
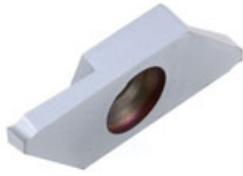

P Steel	☆	☆	★	☆	☆	☆	☆	☆	☆	☆	☆	☆	☆	☆	☆	☆	☆
M Stainless	★	☆	☆	★	☆	☆	☆	☆	☆	☆	☆	☆	☆	☆	☆	☆	☆
N Non-ferrous	☆	☆	☆	☆	☆	☆	☆	☆	☆	☆	☆	☆	☆	☆	☆	☆	☆
S Superalloys	★	☆	☆	☆	☆	☆	☆	☆	☆	☆	☆	☆	☆	☆	☆	☆	☆
H Hard materials	☆	☆	★	☆	☆	☆	☆	☆	☆	☆	☆	☆	☆	☆	☆	☆	☆

★ : First choice
☆ : Second choice

Designation	HAND	Coated						Uncoated	PCD	CUTDIA	CW	INSL	W1	PSIR	REL	RER	Figure
		DM4	DT4	QM3	ST4	VM1	ZM3	KM1	PD1								
CTPA07FRN	R									8	0.7	25	9.4	0°	0.05	0.05	1
CTPA10FRN	R									12	1	25	9.4	0°	0.05	0.05	1
CTPA15FRN	R		●	●		●	●			16	1.5	25	9.4	0°	0.05	0.05	1
CTPA15FRN-CX	R	●			●					16	1.5	25	9.4	0°	0.05	0.05	2
CTPA15FRN-TH	R				●					16	1.5	25	9.4	0°	0.05	0.05	1
CTPA20FRN	R		●	●		●	●			16	2	25	9.4	0°	0.05	0.05	1
CTPA20FRN-P	R							●		16	2	25	9.4	0°	0.1	0.1	4
CTPA20FRN-TH	R				●					16	2	25	9.4	0°	0.05	0.05	1
CTPA20FRNV	R						●		Ⓜ	16	2	25	9.4	0°	0	0	3
CTPA20FRS	R						●			16	2	25	9.4	0°	0.05	0.05	3
CTPA30FRN	R			●						16	3	25	9.4	0°	0.05	0.05	1

NOTE: All angles shown are obtained when insert is set in the holder.

● : Line up

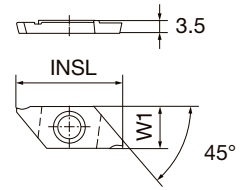
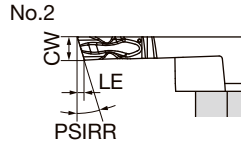
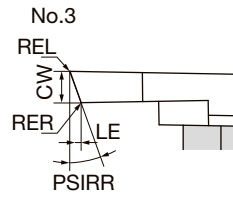
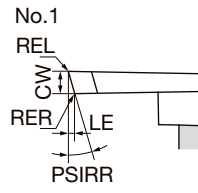
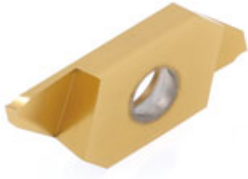

P Steel	☆	☆	★	★	☆	☆	
M Stainless	★	☆	☆	★	☆	☆	
N Non-ferrous							★
S Superalloys	★	☆	☆				
H Hard materials	☆		★				

★ : First choice
☆ : Second choice

Designation	HAND	Coated						Uncoated	CUTDIA	CW	INSL	W1	LE	PSIRR	REL	RER	Figure
		DM4	DT4	QM3	ST4	VM1	ZM3	KM1									
CTPA07FLK	L							6.5	0.7	25	9.4	0.23	16°	0.05	0.05	1	
CTPA10FLK	L							11	1	25	9.4	0.32	16°	0.05	0.05	1	
CTPA10FLKD	L							16	1	25	9.4	0.32	16°	0.05	0.05	1	
CTPA15FLK	L		●	●		●	●	14.5	1.5	25	9.4	0.46	16°	0.05	0.05	1	
CTPA15FLK-CX	L	●			●			14.5	1.5	25	9.4	0.46	16°	0.05	0.05	2	
CTPA15FLK-TH	L				●			14.5	1.5	25	9.4	0.46	16°	0.05	0.05	1	
CTPA20FLK	L		●	●		●	●	14.5	2	25	9.4	0.61	16°	0.05	0.05	1	
CTPA20FLK-TH	L				●			14.5	2	25	9.4	0.61	16°	0.05	0.05	1	
CTPA20FLKV	L					●	●	14.5	2	25	9.4	0.77	20°	0	0	3	

NOTE: All angles shown are obtained when insert is set in the holder.

● : Line up

CTPA-FLN

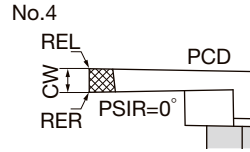
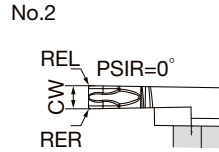
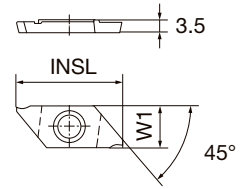
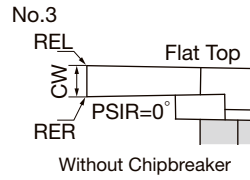
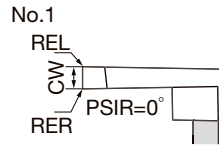

P Steel	☆	☆	★		★	☆						
M Stainless	★	☆	☆	★		☆						
N Non-ferrous						☆	★					
S Superalloys	★	☆	☆									
H Hard materials	☆		★									

★ : First choice
☆ : Second choice

Designation	HAND	Coated							Uncoated	PCD	CUTDIA	CW	INSL	W1	PSIR	REL	RER	Figure
		DM4	DT4	QM3	ST4	VM1	ZM3	KM1										
CTPA10FLN	L							●			12	1	25	9.4	0°	0.05	0.05	1
CTPA10FLND	L							●			16	1	25	9.4	0°	0.05	0.05	1
CTPA15FLN	L		●	●		●	●				16	1.5	25	9.4	0°	0.05	0.05	1
CTPA15FLN-CX	L	●				●					16	1.5	25	9.4	0°	0.05	0.05	2
CTPA15FLN-TH	L					●					16	1.5	25	9.4	0°	0.05	0.05	1
CTPA20FLN	L		●	●		●	●				16	2	25	9.4	0°	0.05	0.05	1
CTPA20FLN-P	L								●		16	2	25	9.4	0°	0.1	0.1	4
CTPA20FLN-TH	L					●					16	2	25	9.4	0°	0.05	0.05	1
CTPA20FLNV	L							●		Ⓜ	16	2	25	9.4	0°	0	0	3
CTPA20FLS	L							●			16	2	25	9.4	0°	0.05	0.05	3
CTPA30FLN	L			●							16	3	25	9.4	0°	0.05	0.05	1

NOTE: All angles shown are obtained when insert is set in the holder.

● : Line up

CTPA-FL

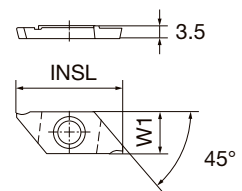
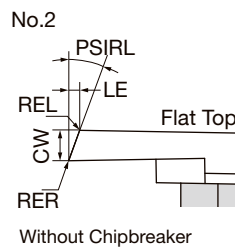
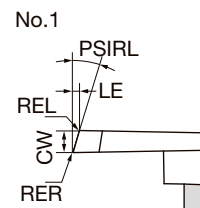

P Steel	☆	★	★
M Stainless	★	☆	☆
N Non-ferrous			★
S Superalloys	☆		
H Hard materials	☆		

★ : First choice
☆ : Second choice

Designation	HAND	Coated			CUTDIA	CW	INSL	W1	LE	PSIRL	REL	RER	Figure
		DT4	VM1	ZM3									
CTPA07FL	L			●	8	0.7	25	9.4	0.23	16°	0.05	0.05	1
CTPA10FL	L			●	12	1	25	9.4	0.32	16°	0.05	0.05	1
CTPA15FL	L	●		●	16	1.5	25	9.4	0.46	16°	0.05	0.05	1
CTPA20FL	L	●		●	16	2	25	9.4	0.61	16°	0.05	0.05	1
CTPA20FLV	L		●	Ⓜ	16	2	25	9.4	0.77	20°	0	0	2

NOTE: All angles shown are obtained when insert is set in the holder.

● : Line up

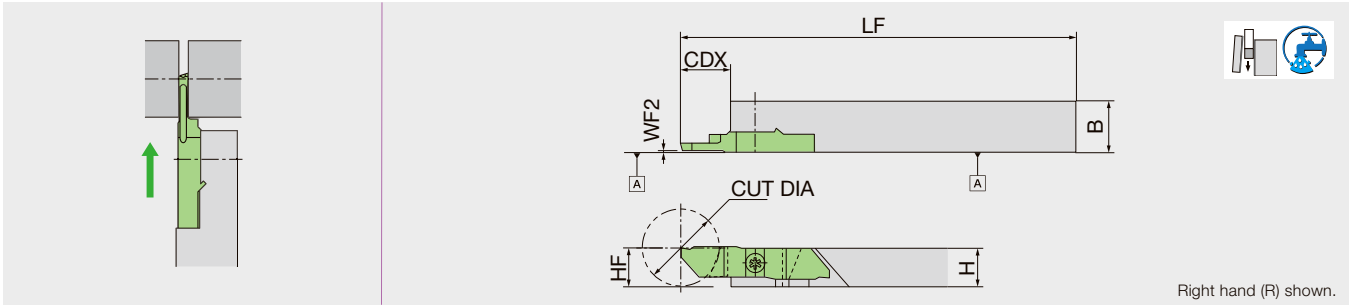

Right hand (R) shown.

Designation	CUTDIA	H	B	LF	CDX	HF	WF2	Insert
CTPWR10	20	10	16	120	15	9.95	0.6	CTPW..
CTPWR12	20	12	16	120	15	11.95	0.6	CTPW..
CTPWR16	20	16	16	120	15	15.95	0.6	CTPW..
CTPWR20	20	20	20	120	15	19.95	0.6	CTPW..
CTPWL10A	20	10	12	120	15	9.95	0.6	CTPW..
CTPWL12A	20	12	12	120	15	11.95	0.6	CTPW..
CTPWL16	20	16	16	120	15	15.95	0.6	CTPW..
CTPWL20	20	20	20	120	15	19.95	0.6	CTPW..

SPARE PARTS



Designation	Clamp screw	Wrench (for Clamp screw)
CTPWR**	LRIS-4*10	LLR-25S

Grade 1
Insert 2
Ext. Toolholder 3
Int. Toolholder 4
Threading 5
Grooving 6
Shaper 7
Endmill 8
Drilling Tool 9
Technical Reference 10

INSERT
CTPW25-R

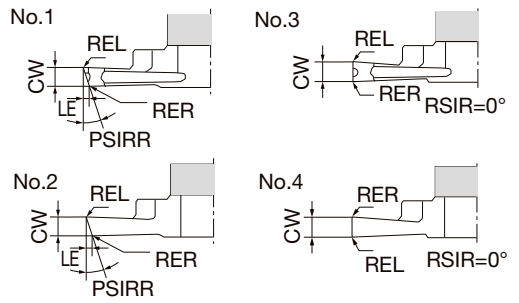
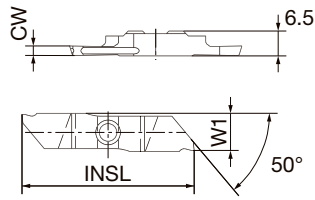
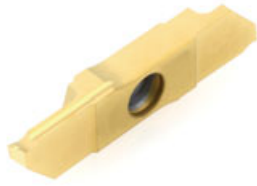

P	Steel	★
M	Stainless	★
N	Non-ferrous	★
S	Superalloys	
H	Hard materials	

★ : First choice
☆ : Second choice



Designation	Coated		CUTDIA	Chip-breaker	CW	INSL	W1	LE	PSIR	PSIRL	PSIRR	REL	RER	Figure
	ZM3													
CTPW25FR	●		20	Yes	2.5	(45)	9.7	0.81	-	-	17°	0.2	0.05	1
CTPW25FRP	●	Ⓜ	20	No	2.5	(45)	9.7	0.81	-	-	17°	0.2	0.05	2
CTPW25FRN	●		20	Yes	2.5	(45)	9.7	-	0°	-	-	0.05	0.05	3
CTPW25FRNV	●	Ⓜ	20	No	2.5	(45)	9.7	-	0°	-	-	0	0	4

NOTE: All angles shown are obtained when insert is set in the holder.

● : Line up

CTPW25-L

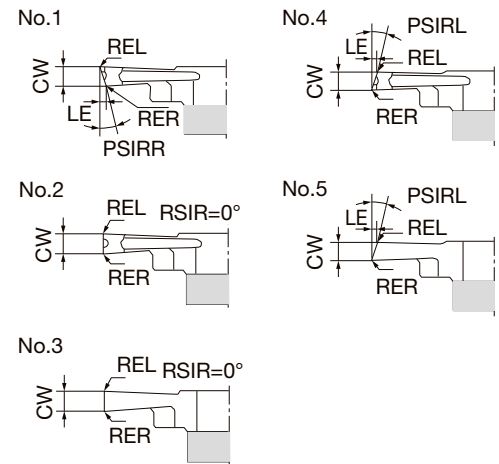
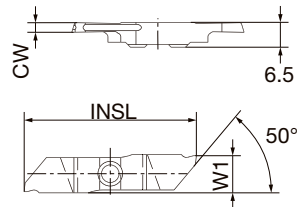

P	Steel	★
M	Stainless	★
N	Non-ferrous	★
S	Superalloys	
H	Hard materials	

★ : First choice
☆ : Second choice

Designation	Coated		CUTDIA	Chip-breaker	CW	INSL	W1	LE	PSIR	PSIRL	PSIRR	REL	RER	Figure
	ZM3													
CTPW25FLK	●		20	Yes	2.5	(45)	9.7	0.81	-	-	17°	0.2	0.05	1
CTPW25FLN	●		20	Yes	2.5	(45)	9.7	-	0°	-	-	0.05	0.05	2
CTPW25FLNV	●	Ⓜ	20	No	2.5	(45)	9.7	-	0°	-	-	0	0	3
CTPW25FL	●		20	Yes	2.5	(45)	9.7	0.81	-	17°	-	0.2	0.05	4
CTPW25FLP	●	Ⓜ	20	No	2.5	(45)	9.7	0.81	-	17°	-	0.2	0.05	5

NOTE: All angles shown are obtained when insert is set in the holder.

● : Line up

Reference pages : Toolholders → **6-97**

Parting-off toolholders with high pressure coolant capability, for swiss lathes

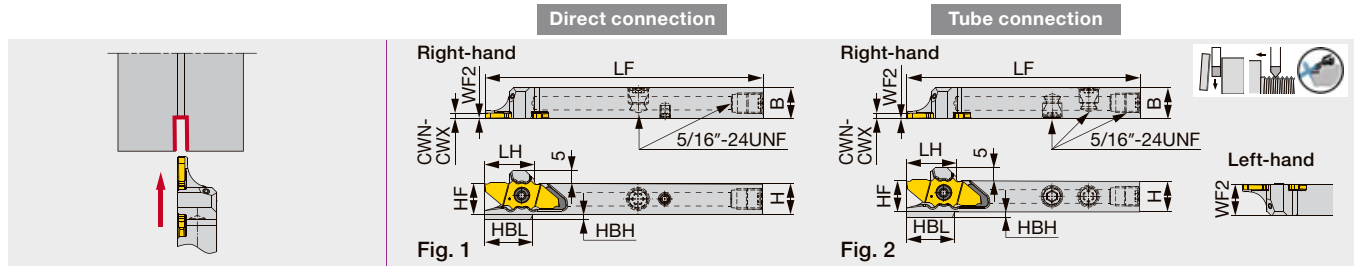

Designation	CWN	CWX	H	B	LF ⁽¹⁾	LH ⁽¹⁾	HF	WF2 ⁽²⁾	HBL ⁽¹⁾	HBH	Insert	Torque*	Fig.
JSXXR/L1012H09-CHP ⁽³⁾	0.6	2.5	10	12	102	19.2	10	0.2/11.8	18.7	3	JX**06...,12...,16...,20...	1.2	1
JSXXR/L1212F09-CHP	0.6	2.5	12	12	85	19.4	12	0.2/11.8	18.8	2	JX**06...,12...,16...,20...	1.2	2
JSXXR/L1212X09-CHP ⁽³⁾	0.6	2.5	12	12	120	19.4	12	0.2/11.8	18.8	2	JX**06...,12...,16...,20...	1.2	1
JSXXR/L1616X09B-CHP ⁽³⁾	0.6	2.5	16	16	120	19.4	16	0.2/15.8	18.7	-	JX**06...,12...,16...,20...	1.2	1

Torque*: Recommended clamping torque (N·m)
 (1) LF (Functional Length) LH (Head Length), and HBL (Head-bottom Offset Length) values shown above are true with JX**16... insert. LF, LH, and HBL will all be 2 mm shorter than the above values with JX**12... and JX**20... inserts, and 4 mm shorter for JX**06... insert.
 (2) The first value before "/" indicates the WF for the right-hand holder and the second value after "/" for the left-hand holder.
 (3) Compatible to the direct internal coolant supply system without the use of external coolant hose.
 (4) To be replaced with the new design
 Note: Use the right-hand insert (JX***R...) for a right-hand holder (JSXXR...); the left-hand insert (JX***L...) for a left-hand holder (JSXXL...).

JSXXR/L-F/X-S-CHP

Parting-off toolholders with high pressure coolant capability, for swiss lathes (for sub spindle)

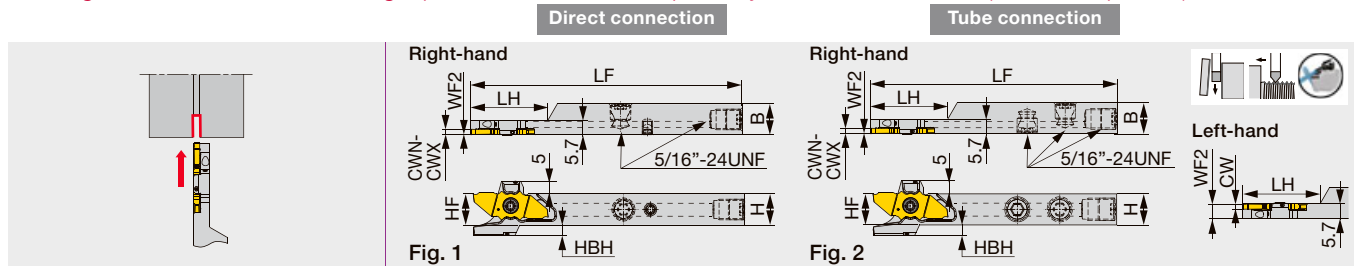

Designation	CWN	CWX	H	B	LF ⁽¹⁾	LH ⁽¹⁾	HF	W2F2 ⁽²⁾	HBH	Insert	Torque*	Fig.
JSXXR1212F09-S-CHP ⁽⁴⁾	0.6	2.5	12	12	85	26	12	0.2	4	JX**06...,12...,16...,20...	1.2	2
JSXXR/L1212F09B-S-CHP	0.6	2.5	12	12	85	30	12	0.2/5.5	2	JX**06...,12...,16...,20...	1.2	2
JSXXR/L1212X09-S-CHP ^{(3),(4)}	0.6	2.5	12	12	120	30	12	0.2/5.5	4	JX**06...,12...,16...,20...	1.2	1
JSXXR/L1212X09B-S-CHP ⁽³⁾	0.6	2.5	12	12	120	30	12	0.2/5.5	2	JX**06...,12...,16...,20...	1.2	1
JSXXR1616X09-S-CHP ^{(3),(4)}	0.6	2.5	16	16	120	30	16	0.2	1.5	JX**06...,12...,16...,20...	1.2	1
JSXXR/L1616X09B-S-CHP ⁽³⁾	0.6	2.5	16	16	120	30	16	0.2/5.5	-	JX**06...,12...,16...,20...	1.2	1

Torque*: Recommended clamping torque (N·m)
 (1) LF (Functional Length) and LH (Head Length) values shown above are true with JX**16... insert. Both LF and LH will be 2 mm shorter than the above value with JX**12... and JX**20... inserts; 4 mm shorter with JX**06... insert.
 (2) The first value before "/" indicates the WF for the right-hand holder and the second value after "/" for the left-hand holder.
 (3) Compatible to the direct internal coolant supply system without the use of external coolant hose.
 (4) To be replaced with the new design
 Note: Use the right-hand insert (JX***R...) for a right-hand holder (JSXXR...); the left-hand insert (JX***L...) for a left-hand holder (JSXXL...).

SPARE PARTS

Designation	Clamping screw	Wrench 1	Coolant plug	Wrench 2	DirectJet plug	Wrench 3
JSXXR**F...	CSTC-4L100DL	T-1008/5	SR5/16UNFTL360	P-4	-	-
JSXXL**F...	CSTC-4L100DR	T-1008/5	SR5/16UNFTL360	P-4	-	-
JSXXR**H/X...	CSTC-4L100DL	T-1008/5	SR5/16UNFTL360	P-4	SSHM4-6-TB	P-2
JSXXL**H/X...	CSTC-4L100DR	T-1008/5	SR5/16UNFTL360	P-4	SSHM4-6-TB	P-2

INSERTS

JXPS**R/L-F (with 3D chipbreaker, sharp edge)

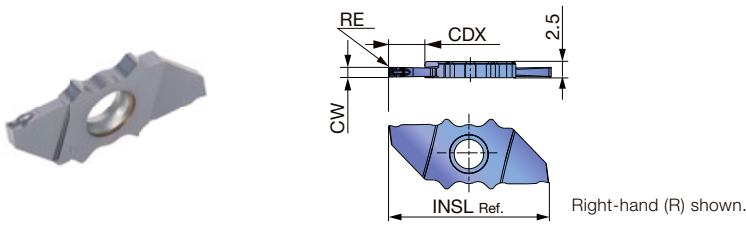

P	Steel	★	★				
M	Stainless	★	★				
K	Cast iron	★	★				
N	Non-ferrous						
S	Superalloys	★	★				
H	Hard materials						

★ : First choice



Designation	HAND	CW±0.025	RE	Coated				CUTDIA	CDX*	INSL
				SH7025	SH725					
JXPS06R06F	R	0.6	0.05	●	●			6	3.5	21
JXPS06L06F	L	0.6	0.05	●	●			6	3.5	21
JXPS12R08F	R	0.8	0.05	●	●			12	6.5	25
JXPS12L08F	L	0.8	0.05	●	●			12	6.5	25
JXPS12R10F	R	1	0.05	●	●			12	6.5	25
JXPS12L10F	L	1	0.05	●	●			12	6.5	25
JXPS12R15F	R	1.5	0.05	●	●			12	6.5	25
JXPS12L15F	L	1.5	0.05	●	●			12	6.5	25
JXPS16R15F	R	1.5	0.05	●	●			16	8.5	29
JXPS16L15F	L	1.5	0.05	●	●			16	8.5	29
JXPS20R20F	R	2	0.05	●	●			20	10.5	33
JXPS20L20F	L	2	0.05	●	●			20	10.5	33

*Max grooving depth (CDX) varies depending on workpiece diameters.

● : Line up

JXDX**R-F (PCD insert)

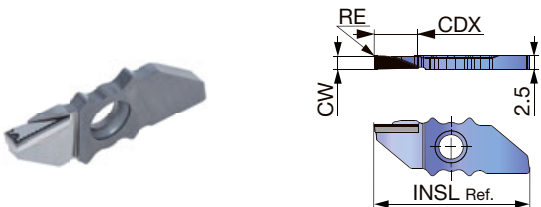

P	Steel						
M	Stainless						
K	Cast iron						
N	Non-ferrous	★					
S	Superalloys						
H	Hard materials						

★ : First choice

Designation	HAND	CW±0.05	RE	PCD				CDX	INSL
				DX110					
JXDX12R20F	R	2	< 0.1	●				6	25
JXDX12R25F	R	2.5	< 0.1	●				6.5	25
JXDX16R25F	R	2.5	< 0.1	●				7	29

● : Line up

Reference pages: Toolholders → 6-99, Standard cutting conditions → 6-102, 6-103

JXPGR/L-F (Sharp edge)**

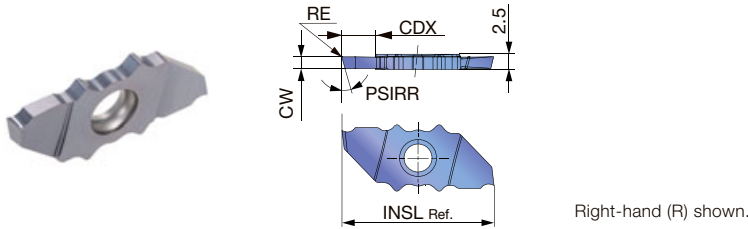

P	Steel	★	★				
M	Stainless	★	★				
K	Cast iron	★	★				
N	Non-ferrous						
S	Superalloys	★	★				
H	Hard materials						

★ : First choice

Designation	HAND	CW±0.025	RE	Coated		CUTDIA	CDX*	INSL	PSIRR
				SH7025	SH725				
JXPG06R10F	R	1	0.05	●	●	6	3.5	21	0°
JXPG06L10F	L	1	0.05	●	●	6	3.5	21	0°
JXPG06R15F	R	1.5	0.05	●	●	6	3.5	21	0°
JXPG06L15F	L	1.5	0.05	●	●	6	3.5	21	0°
JXPG06R10F-15	R	1	0.05	●	●	6	3.5	21	15°
JXPG06L10F-15	L	1	0.05	●	●	6	3.5	21	15°
JXPG06R15F-15	R	1.5	0.05	●	●	6	3.5	21	15°
JXPG06L15F-15	L	1.5	0.05	●	●	6	3.5	21	15°
JXPG12R15F	R	1.5	0.05	●	●	12	6.5	25	0°
JXPG12L15F	L	1.5	0.05	●	●	12	6.5	25	0°
JXPG12R20F	R	2	0.05	●	●	12	6.5	25	0°
JXPG12L20F	L	2	0.05	●	●	12	6.5	25	0°
JXPG12R15F-15	R	1.5	0.05	●	●	12	6.5	25	15°
JXPG12L15F-15	L	1.5	0.05	●	●	12	6.5	25	15°
JXPG12R20F-15	R	2	0.05	●	●	12	6.5	25	15°
JXPG12L20F-15	L	2	0.05	●	●	12	6.5	25	15°
JXPG16R15F	R	1.5	0.05	●	●	16	8.5	29	0°
JXPG16L15F	L	1.5	0.05	●	●	16	8.5	29	0°
JXPG16R20F	R	2	0.05	●	●	16	8.5	29	0°
JXPG16L20F	L	2	0.05	●	●	16	8.5	29	0°
JXPG16R15F-15	R	1.5	0.05	●	●	16	8.5	29	15°
JXPG16L15F-15	L	1.5	0.05	●	●	16	8.5	29	15°
JXPG16R20F-15	R	2	0.05	●	●	16	8.5	29	15°
JXPG16L20F-15	L	2	0.05	●	●	16	8.5	29	15°
JXPG20R15F	R	1.5	0.05	●	●	20	10.5	33	0°
JXPG20L15F	L	1.5	0.05	●	●	20	10.5	33	0°
JXPG20R20F	R	2	0.05	●	●	20	10.5	33	0°
JXPG20L20F	L	2	0.05	●	●	20	10.5	33	0°
JXPG20R15F-15	R	1.5	0.05	●	●	20	10.5	33	15°
JXPG20L15F-15	L	1.5	0.05	●	●	20	10.5	33	15°
JXPG20R20F-15	R	2	0.05	●	●	20	10.5	33	15°
JXPG20L20F-15	L	2	0.05	●	●	20	10.5	33	15°

*Max grooving depth (CDX) varies depending on workpiece diameters.

● : Line up

STANDARD CUTTING CONDITIONS

Parting, Grooving

ISO	Workpiece materials	Grades	Cutting speed Vc (m/min)	Feed f (mm/rev)
P	Low carbon steels S15C, SS400, etc. C15E4, E275A, etc.	SH725	50 - 200	0.01 - 0.05
	Carbon steels, Alloy steels S55C, SCM440, etc. C55, 42CrMo4, etc.	SH725	50 - 200	0.01 - 0.05
	Free cutting steels SUH22, SUH23, etc.	SH725	50 - 200	0.01 - 0.05
M	Stainless steels SUS304, X5CrNi18-9, etc.	SH725	50 - 200	0.01 - 0.05
N	Aluminium alloys A5056, A6061, etc.	SH725	150 - 200	0.01 - 0.05
	Copper alloy C2600, C280C, etc.	SH725	100 - 200	0.01 - 0.05
S	Titanium alloys Ti-6Al-4V, etc.	SH725	30 - 80	0.01 - 0.05
	Superalloys Inconel718, etc.	SH725	30 - 80	0.01 - 0.05



For aluminium and non-ferrous metal PCD insert

ISO	Workpiece materials	Grades	Operation	Cutting speed Vc (m/min)	Feed f (mm/rev)	Depth of cut ap (mm)
N	Aluminium alloys A5056, A6061, etc.	DX110	Grooving	100 - 300	0.03 - 0.15	-
		DX110	Turning	100 - 300	0.03 - 0.15	< 6

Maximum grooving depths (T) in relation to workpiece diameters (øD max) without interference

Maximum grooving depth (T) is limited relative to workpiece diameter (øD max) to avoid interference between workpiece and insert.

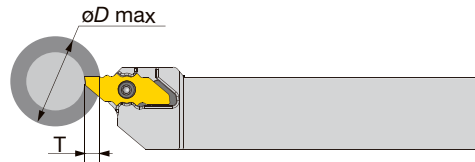

Grooving depths (T) and workpiece diameters (øD max) for each insert

Designation	T≤1.0	T≤2.0	T≤2.5	T≤3.0	T≤3.5	T≤4.0	T≤5.0	T≤5.5	T≤6.0	T≤6.5	T≤7.0	T≤7.5	T≤8.0	T≤8.5	T≤9.0	T≤9.5	T≤10.0	T≤10.5
JXP*06...	∞	∞	200	60	30	-	-	-	-	-	-	-	-	-	-	-	-	-
JXP*12...	∞	∞	∞	∞	∞	∞	∞	100	60	35	-	-	-	-	-	-	-	-
JXP*16...	∞	∞	∞	∞	∞	∞	∞	∞	∞	∞	200	90	50	25	-	-	-	-
JXP*20...	∞	∞	∞	∞	∞	∞	∞	∞	∞	∞	∞	∞	∞	∞	200	80	50	25

HOW TO SELECT TOOLS

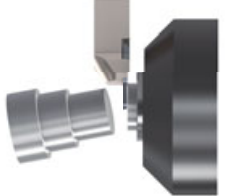
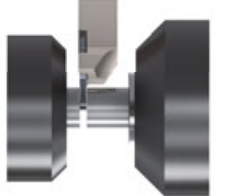
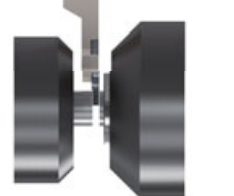
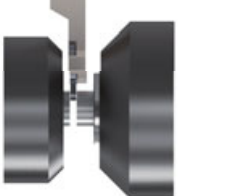
Application	Large-diameter machining of workpiece with rigidity		Small-diameter machining of workpiece with short overhang	
	Main-spindle tooling	Sub-spindle tooling	Sub-spindle tooling	
			Workpiece with long overhang at the side of sub-spindle for the process after parting-off	Short workpiece with low rigidity
 <p>Main spindle</p> <p>Position of parting-off is at the side of the main spindle</p>	 <p>Sub-spindle Main spindle</p> <p>Position of parting-off is at the side of the sub-spindle</p>	 <p>Sub-spindle Main spindle</p> <p>Position of parting-off is at the side of the main spindle</p>	 <p>Sub-spindle Main spindle</p> <p>Position of parting-off is at the side of the sub-spindle</p>	
Toolholder	R-hand (JSXXR type)	L-hand (JSXXL type)	R-hand (JSXXR-S type)	L-hand (JSXXL-S type)
Insert	Right-hand insert with lead angle to remove center core (JXPG**R***-15 type)	Left-hand insert (JXPG**L*** type)	Right-hand insert (JXPG**R*** type)	Left-hand insert (JXPG**L*** type)

HOW TO SELECT TOOLHOLDERS FOR SUB-SPINDLE

Sub-spindle dia.	Parting-off dia.	B	LF	Insert	Toolholder
ø40	~ ø6	10	116	JXPG06*	JSXXR/L1010X09-S
ø40	~ ø6	12	81	JXPG06*	JSXXR/L1212F09-S
ø40	~ ø12	10	118	JXPG12*	JSXXR/L1010X09-S
ø40	~ ø12	12	83	JXPG12*	JSXXR/L1212F09-S
ø40	~ ø16	10	120	JXPG16*	JSXXR/L1010X09-S
ø40	~ ø16	12	85	JXPG16*	JSXXR/L1212F09-S
ø40	~ ø20	12	87	JXPG20*	JSXXR/L1212F09B-S-CHP
ø50	~ ø6	12	116	JXPG06*	JSXXR/L1212X09-S
ø50	~ ø6	16	116	JXPG06*	JSXXR/L1616X09-S
ø50	~ ø12	12	118	JXPG12*	JSXXR/L1212X09-S
ø50	~ ø12	16	118	JXPG12*	JSXXR/L1616X09-S
ø50	~ ø16	12	85	JXPG16*	JSXXR/L1212F09-S
ø50	~ ø16	12	120	JXPG16*	JSXXR/L1212X09-S
ø50	~ ø16	16	120	JXPG16*	JSXXR/L1616X09-S
ø50	~ ø20	12	87	JXPG20*	JSXXR/L1212F09B-S-CHP
ø50	~ ø20	12	122	JXPG20*	JSXXR/L1212X09B-S-CHP
ø50	~ ø20	16	122	JXPG20*	JSXXR/L1616X09-S

MAX. PARTING-OFF DIA. & DEPTH

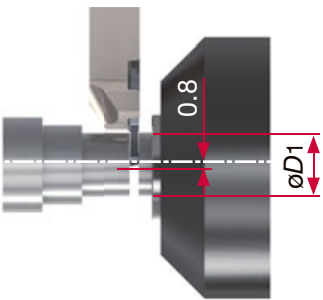
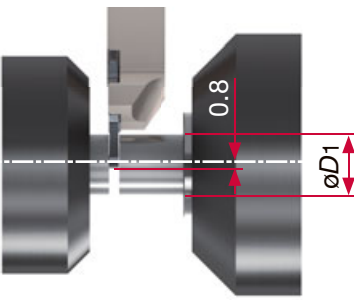
Main-spindle tooling	Sub-spindle tooling
 <p>Main spindle</p>	 <p>Sub-spindle Main spindle</p>

There will be no tool-workpiece interference when parting off the workpiece with the cutting edge position apart from the workpiece center by 0.8 mm or more.

Grade
1
Insert
2
Ext. Toolholder
3
Int. Toolholder
4
Threading
5
Grooving
6
Shaper
7
Endmill
8
Drilling Tool
9
Technical Reference
10

Modular head for external grooving and parting, with high pressure coolant capability

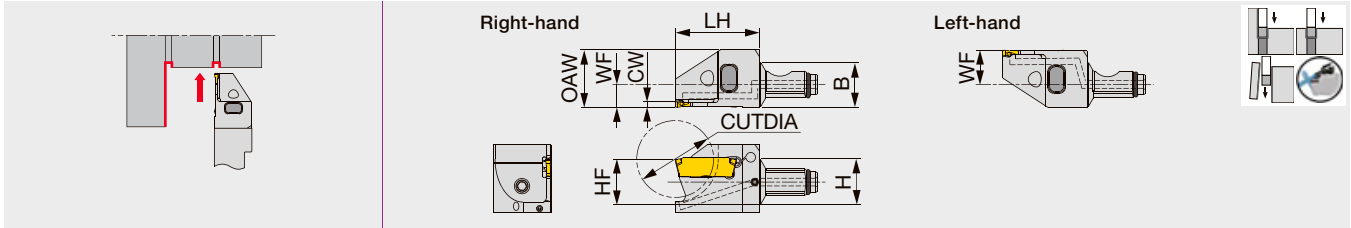

Designation	CW	Seat size	CUTDIA	H	B	LH	HF	WF ⁽¹⁾	OAW	Torque*
QC12-JTTER/L1.2D20-CHP	1.2	0.9	20	12	12	22	12	6/9	15	1.5
QC12-JTTER/L1.4D20-CHP	1.4	1	20	12	12	22	12	6/9	15	1.5
QC12-JTTER/L2D20-CHP	2	2	20	12	12	22	12	6/9	15	1.5

(1) "WF" value is calculated with groove width "CW" shown in the table. The first value before "/" indicates the WF for the right-hand holder and the second value after "/" for the left-hand holder.

Torque*: Recommended clamping torque (N·m)

JTTER/L

External grooving and parting toolholder, for Swiss lathes

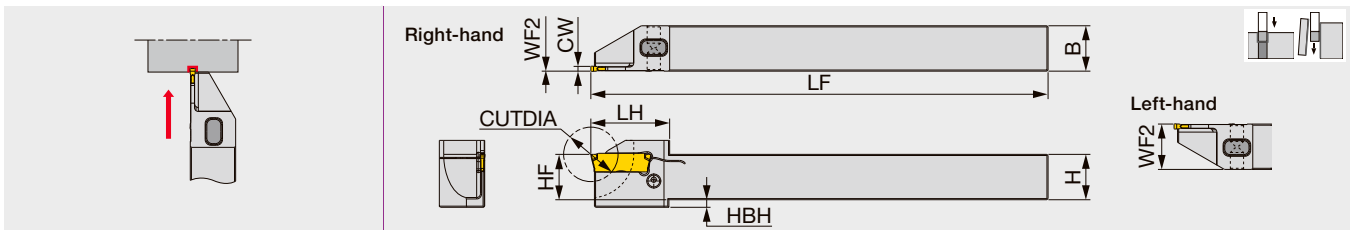

Designation	CW	Seat size	CUTDIA	H	B	LF	LH	HF	WF2 ⁽¹⁾	HBH	Torque*
JTTER/L1010H1.2D12	1.2	0.9	12	10	10	100	17	10	0/10	-	1.5
JTTER/L1212F1.2D16	1.2	0.9	16	12	12	85	19	12	0/12	-	1.5
JTTER/L1212X1.2D16	1.2	0.9	16	12	12	120	19	12	0/12	-	1.5
JTTER/L1212X1.2D20	1.2	0.9	20	12	12	120	21	12	0/12	2	1.5
JTTER/L1616X1.2D20	1.2	0.9	20	16	16	120	21	16	0/16	-	2

(1) "WF" value is calculated with groove width "CW" shown in the table. The first value before "/" indicates the WF for the right-hand holder and the second value after "/" for the left-hand holder.

Torque*: Recommended clamping torque (N·m)

SPARE PARTS

Designation	Clamping screw	Clamping pin	Wrench	O-ring
QC12-JTTER/L... JTTER/L1010, 1212...	SSM3.5x0.35	PIN-SL-TC	P-2F	ORSS-0454.5X1.0NBR70
JTTER/L1616...	SRM5-24145-RL	PIN-32121	P-2.5F	-

Reference pages: QC12-JTTER/L-CHP, JCTER/L: Inserts → [6-106 - 6-113](#)

Shank, Accessory → [3-120, 3-121](#), Standard cutting conditions → [6-114](#)

JCTER/L

External grooving and parting toolholder, for Swiss lathes

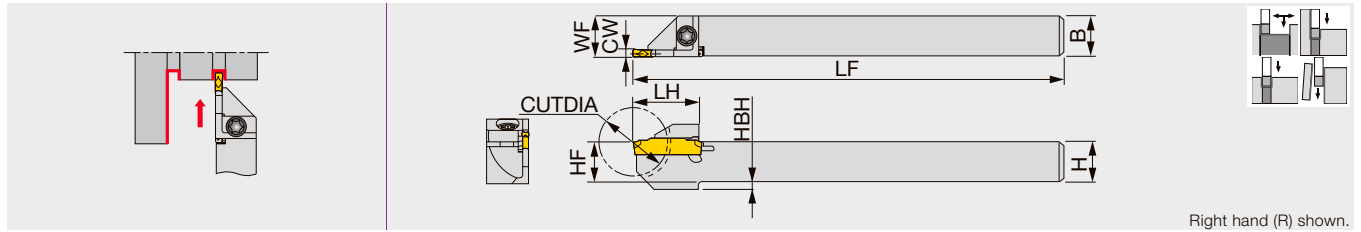

Designation	CW	Seat size	CUTDIA	H	B	LF	LH	HF	WF ⁽¹⁾	HBH	Torque*
JCTER/L1010X1.4T10	1.4	1	20	10	10	120	18	10	10.2	-	3
JCTER/L1212F1.4T12	1.4	1	24	12	12	85	19.5	12	12.2	-	3
JCTER/L1212X1.4T12	1.4	1	24	12	12	120	19.5	12	12.2	-	3
JCTER/L1414-1.4T12	1.4	1	24	14	14	125	19.5	14	14.2	-	3
JCTER/L1616X1.4T16	1.4	1	32	16	16	120	24	16	16.2	-	3
JCTER/L1010X2T10	2	2	20	10	10	120	19	10	10.1	2	3
JCTER/L1212F2T12	2	2	24	12	12	85	19	12	12.1	2	3
JCTER/L1212X2T12	2	2	24	12	12	120	19	12	12.1	2	3
JCTER/L1414-2T12	2	2	24	14	14	125	19	14	14.1	-	3
JCTER/L1616X2T16	2	2	32	16	16	120	24	16	16.1	-	3
JCTER/L1212F3T12	3	3	24	12	12	85	19	12	12.3	2	3
JCTER/L1212X3T12	3	3	24	12	12	120	19	12	12.3	2	3
JCTER/L1616X3T16	3	3	32	16	16	120	24	16	16.3	-	3
JCTER/L2020H3T16	3	3	32	20	20	100	24	20	20.3	-	3

(1) The value for "WF" is true when the insert with the width, indicated in "CW" in the table is mounted. • CUTDIA: Maximum parting-off diameter
Torque*: Recommended torque (N·m) for clamping

JCTER/L2012

External grooving and parting toolholder, for Swiss lathes

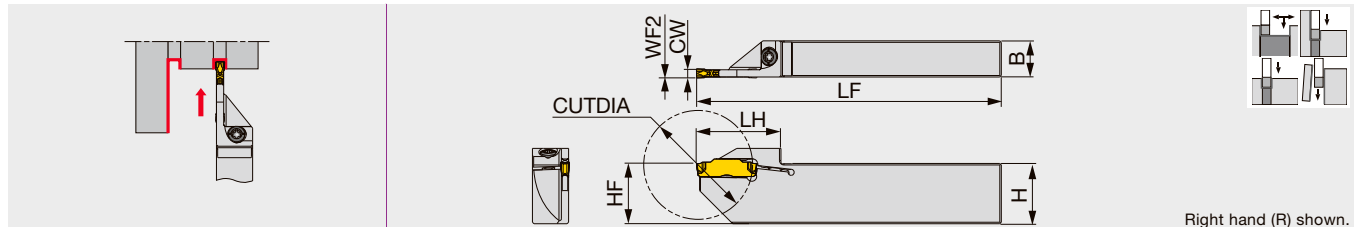

Designation	CW	Seat size	CUTDIA	H	B	LF	LH	HF	WF2 ⁽¹⁾	Torque*
JCTER/L2012H2T18	2	2	36	20	12	100	25	20	0.1	3
JCTER/L2012H3T21	3	3	42	20	12	100	28	20	0.3	3

(1) "WF" value is calculated with groove width "CW" shown in the table. • CUTDIA: Max. parting diameter
Torque*: Recommended clamping torque (N·m)

SPARE PARTS

Designation	Clamping screw	Wrench
JCTER/L...	CSHB-4-A	T-15F
JCTER/L2012...		

External grooving and parting-off toolholder, high pressure coolant compatible

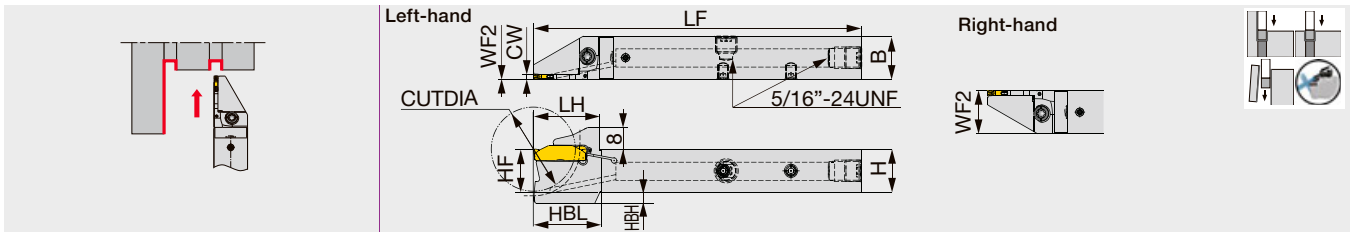

Designation	CW	Seat size	CUTDIA	H	B	LF	LH	HBL	HF	WF2 ⁽¹⁾	HBH	Torque*
JCTER/L1212X2T12-CHP	2	2	25	12	12	120	24.7	24.7	12	0/12	5	3.0
JCTER/L1616X2T12-CHP	2	2	25	16	16	120	24.7	24.5	16	0/16	1	3.0
JCTER/L1616X2T16-CHP	2	2	32	16	16	120	24.7	24.7	16	0/16	4	3.0
JCTER/L2020X2T16-CHP	2	2	32	20	20	120	24.7	-	20	0/20	0	3.0





(1) "WF" value is calculated with groove width "CW" shown in the table. • CUTDIA: Max. parting off dia.
Torque*: Recommended torque (N-m) for clamping

SPARE PARTS

Designation	Clamping screw	Wrench	Coolant plug	Wrench	DirectJet plug	Wrench	Wrench (Option)
JCTER/L...	CSHB-4-A	T-15F	SR5/16UNFTL360	P-4	SSH4-6-TB	P-2	-

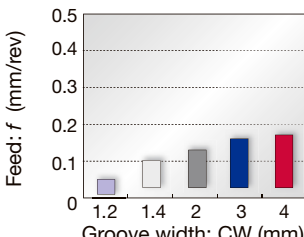
CHIPBREAKER GUIDE

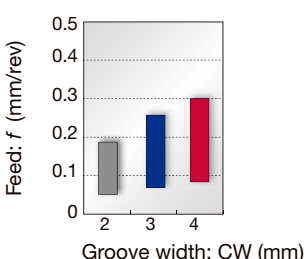
External grooving and parting

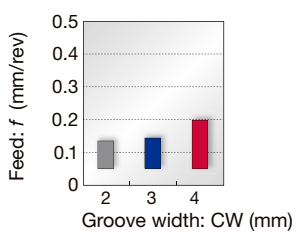
<p>DGS type (2 corners) SGS type (1 corner)</p>  <p>6-108, 6-111</p>	<p>For Swiss lathes</p> <p>Unique-designed edge and chipbreaker Handed insert available CW = 1.2 - 4 mm</p>	<p>Standard feed</p> 
<p>DGM type (2 corners) SGM type (1 corner)</p>  <p>6-109, 6-110</p>	<p>High fracture resistance</p> <p>Smooth chip evacuation Well-designed edge with high strength Handed insert available CW = 2 - 4 mm</p>	<p>Standard feed</p> 
<p>DGL type (2 corners)</p>  <p>6-113</p>	<p>1st choice for mild steel</p> <p>Chipbreaker with excellent chip control at low feed Suitable for mild steel that often has difficulties in chip control CW = 2 - 4 mm</p>	<p>Standard feed</p> 

Reference pages: JCTER/L-CHP: Inserts → [6-106 - 6-113](#)
Standard cutting conditions → [6-114](#)

External grooving

DGE type (2 corners)

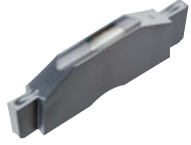

6-112

For shallow grooves with high accuracy

Excellent chip control
CW = 1 - 2.15 mm

■ Standard feed

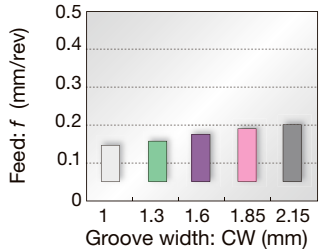

Groove width: CW (mm)	Feed: f (mm/rev)
1	0.12
1.3	0.15
1.6	0.16
1.85	0.18
2.15	0.19



DGG type (2 corners)



6-112

For non-ferrous materials and titanium alloys

Chipbreaker with low cutting force
Sharp cutting edge that prevents vibration and delivers fine surface finish
CW = 2 - 4 mm

■ Standard feed

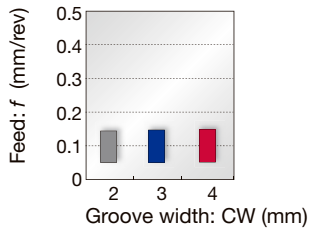

Groove width: CW (mm)	Feed: f (mm/rev)
2	0.15
3	0.16
4	0.17

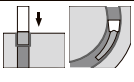

External grooving of hardened steels

SGN-CBN type (1 corner)

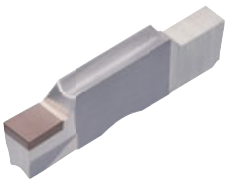

6-113

For hardened steel cutting

Optimum cutting edge shape for grooving of hardened steels
Close tolerance width for finishing (W = ±0.025 mm)
CW = 2 - 4 mm

■ Standard feed

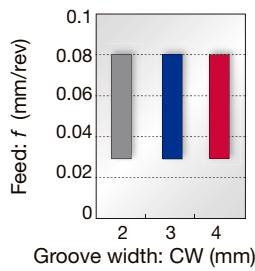

Groove width: CW (mm)	Feed: f (mm/rev)
2	0.08
3	0.08
4	0.08



INSERT

DGS

External grooving and parting

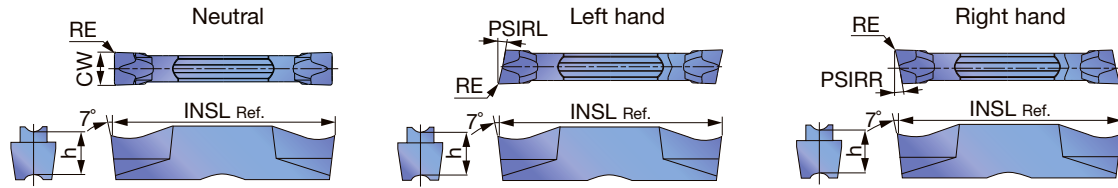

P	Steel	★	★	☆	★	☆	★	★						
M	Stainless		★	☆	★	★	★							
K	Cast iron		★		★	☆	★		☆			☆		
N	Non-ferrous											☆		
S	Superalloys		★	☆	★							★		
H	Hard materials													

★ : First choice
☆ : Second choice

Designation	Seat size	HAND	CW±0.05	RE	Coated						Cermet	Uncoated		INSL	h	PSIRL	PSIRR
					T9225	AH7025	AH725	AH8005	GH130	AH6235	NS9530	KS05F					
DGS1.2-003	0.9	N	1.2	0.03										16	4.7	0°	0°
DGS1.4-005	1	N	1.4	0.05										16	4.3	0°	0°
DGS1.4-010	1	N	1.4	0.1										16	4.3	0°	0°
DGS1.4-016	1	N	1.4	0.16										16	4.3	0°	0°
DGS2-005	2	N	2	0.05										20	5	0°	0°
DGS2-010	2	N	2	0.1										20	5	0°	0°
DGS2-020	2	N	2	0.2										20	5	0°	0°
DGS2-020-6R	2	R	2	0.2										20	5	0°	6°
DGS2-020-6L	2	L	2	0.2										20	5	6°	0°
DGS2-002-6R	2	R	2	0.02										19.5	5	0°	6°
DGS2-002-6L	2	L	2	0.02										19.5	5	6°	0°
DGS2-020-15R	2	R	2	0.2										20	5	0°	15°
DGS2-020-15L	2	L	2	0.2										20	5	15°	0°
DGS2-002-15R	2	R	2	0.02										19.5	5	0°	15°
DGS2-002-15L	2	L	2	0.02										19.5	5	15°	0°
DGS2.39-020	2	N	2.39	0.2										20	5	0°	0°
DGS3-020	3	N	3	0.2										20	5	0°	0°
DGS3-020-6R	3	R	3	0.2										20	5	0°	6°
DGS3-020-6L	3	L	3	0.2										20	5	6°	0°
DGS3-002-6R	3	R	3	0.02										19.45	5	0°	6°
DGS3-002-6L	3	L	3	0.02										19.45	5	6°	0°
DGS3-020-15R	3	R	3	0.2										20	5	0°	15°
DGS3-020-15L	3	L	3	0.2										20	5	15°	0°
DGS3-002-15R	3	R	3	0.02										19.45	5	0°	15°
DGS3-002-15L	3	L	3	0.02										19.45	5	15°	0°
DGS3.18-020	3	N	3.18	0.2										20	5	0°	0°
DGS4-030	4	N	4	0.3										20	5	0°	0°
DGS4-030-4R	4	R	4	0.3										20	5	0°	4°
DGS4-030-4L	4	L	4	0.3										20	5	4°	0°
DGS4.76-040	5	N	4.76	0.4										25	5.5	0°	0°
DGS5-030	5	N	5	0.3										25	5.5	0°	0°
DGS6-030	6	N	6	0.3										25	5.5	0°	0°
DGS6.35-040	6	N	6.35	0.4										25	5.5	0°	0°
DGS8-040	8	N	8	0.4										30	6.7	0°	0°

● : Line up

Caution

The tool will interfere with the workpiece when grooving larger diameters than ϕD_{max} .

Designation	ϕD_{max} (mm)	Designation	ϕD_{max} (mm)
DGM2-002-15R/L	28	DGS2-002-15R/L	28
DGM3-002-15R/L	29	DGS3-002-15R/L	29
DGM4-030-15R/L	30	SGS3-020-15R/L	103
SGM3-020-15R/L	103	SGS3-002-15R/L	34

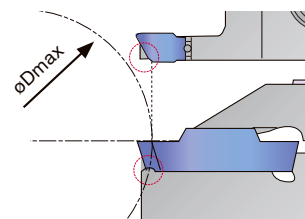

Reference pages: Toolholders → [6-104](#) - [6-106](#), Standard cutting conditions → [6-114](#)

DGM

External grooving and parting

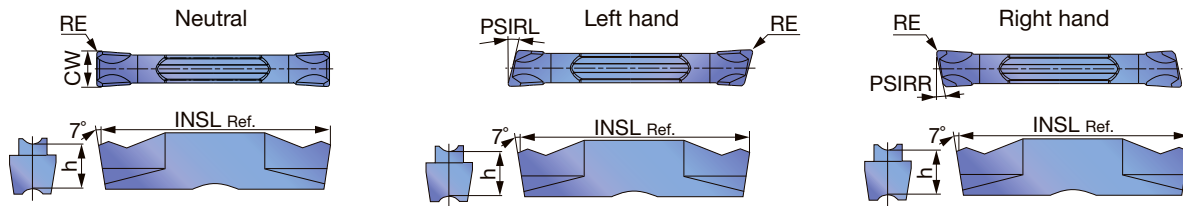

P Steel	★	★	☆	★	☆	★	★	★						
M Stainless		★	☆	★	★	★	★	★						
K Cast iron		★		★	☆	☆	★	☆			☆			
N Non-ferrous											☆			
S Superalloys		★	☆	★	★						★			
H Hard materials														

★ : First choice
☆ : Second choice

Designation	Seat size	HAND	CW±0.05	RE	Coated						Cermet	Uncoated		INSL	h	PSIRL	PSIRR
					T9225	AH7025	AH725	AH8005	AH905	GH130		AH6235	NS9530				
DGM2-020	2	N	2	0.2	●	●	●	●	●	●	●	●	●	20	5	0°	0°
DGM2-020-6R	2	R	2	0.2	●	●	●	●	●	●	●	●	●	20	5	0°	6°
DGM2-020-6L	2	L	2	0.2	●	●	●	●	●	●	●	●	●	20	5	6°	0°
DGM2-020-8R	2	R	2	0.2	●	●	●	●	●	●	●	●	●	20	5	0°	8°
DGM2-020-8L	2	L	2	0.2	●	●	●	●	●	●	●	●	●	20	5	8	0°
DGM2-020-15R	2	R	2	0.2	●	●	●	●	●	●	●	●	●	20	5	0°	15°
DGM2-020-15L	2	L	2	0.2	●	●	●	●	●	●	●	●	●	20	5	15°	0°
DGM2-002-15R	2	R	2	0.02	●	●	●	●	●	●	●	●	●	19.35	5	0°	15°
DGM2-002-15L	2	L	2	0.02	●	●	●	●	●	●	●	●	●	19.35	5	15°	0°
DGM2.39-020	2	N	2.39	0.2	●	●	●	●	●	●	●	●	●	20	5	0°	0°
DGM3-020	3	N	3	0.2	●	●	●	●	●	●	●	●	●	20	5	0°	0°
DGM3-020-6R	3	R	3	0.2	●	●	●	●	●	●	●	●	●	20	5	0°	6°
DGM3-020-6L	3	L	3	0.2	●	●	●	●	●	●	●	●	●	20	5	6°	0°
DGM3-002-6R	3	R	3	0.02	●	●	●	●	●	●	●	●	●	19.45	5	0°	6°
DGM3-002-6L	3	L	3	0.02	●	●	●	●	●	●	●	●	●	19.45	5	6°	0°
DGM3-020-15R	3	R	3	0.2	●	●	●	●	●	●	●	●	●	20	5	0°	15°
DGM3-020-15L	3	L	3	0.2	●	●	●	●	●	●	●	●	●	20	5	15°	0°
DGM3.18-020	3	N	3.18	0.2	●	●	●	●	●	●	●	●	●	20	5	0°	0°
DGM4-030	4	N	4	0.3	●	●	●	●	●	●	●	●	●	20	5	0°	0°
DGM4-030-4R	4	R	4	0.3	●	●	●	●	●	●	●	●	●	20	5	0°	4°
DGM4-030-4L	4	L	4	0.3	●	●	●	●	●	●	●	●	●	20	5	4°	0°
DGM4-030-15R	4	R	4	0.3	●	●	●	●	●	●	●	●	●	20	5	0°	15°
DGM4-030-15L	4	L	4	0.3	●	●	●	●	●	●	●	●	●	20	5	15°	0°
DGM4.76-040	5	N	4.76	0.4	●	●	●	●	●	●	●	●	●	25	5.5	0°	0°
DGM5-030	5	N	5	0.3	●	●	●	●	●	●	●	●	●	25	5.5	0°	0°
DGM5-030-4R	5	R	5	0.3	●	●	●	●	●	●	●	●	●	25	5.5	0°	4°
DGM6-030	6	N	6	0.3	●	●	●	●	●	●	●	●	●	25	5.5	0°	0°
DGM6.35-040	6	N	6.35	0.4	●	●	●	●	●	●	●	●	●	25	5.5	0°	0°
DGM8-040	8	N	8	0.4	●	●	●	●	●	●	●	●	●	30	6.7	0°	0°

● : Line up

External deep grooving and parting

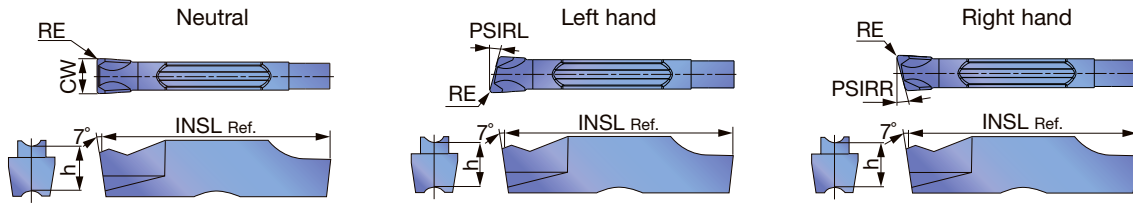

P	Steel	★	☆	★	☆	★								
M	Stainless	★	☆	★	★	★								
K	Cast iron	★		★	☆	★		☆						
N	Non-ferrous							☆						
S	Superalloys	★	☆	★				★						
H	Hard materials													

★ : First choice
☆ : Second choice

Designation	Seat size	HAND	CW±0.05	RE	Coated					Uncoated				INSL	h	PSIRL	PSIRR
					AH7025	AH725	AH8005	GH130	AH6235	KS05F							
SGM2-020	2	N	2	0.2	●	●	●	●	●	●				20	5	0°	0°
SGM2-020-6R	2	R	2	0.2	●	●	●	●						20	5	0°	6°
SGM2-020-6L	2	L	2	0.2	●	●	●	●						20	5	6°	0°
SGM3-020	3	N	3	0.2	●	●	●	●	●	●				20	5	0°	0°
SGM3-020-6R	3	R	3	0.2	●	●	●	●						20	5	0°	6°
SGM3-020-6L	3	L	3	0.2	●	●	●	●						20	5	6°	0°
SGM3-020-15R	3	R	3	0.2	●	●	●	●						20	5	0°	15°
SGM3-020-15L	3	L	3	0.2	●	●	●	●						20	5	15°	0°
SGM4-030	4	N	4	0.3	●	●	●	●	●	●				20	5	0°	0°
SGM4-030-4R	4	R	4	0.3	●	●	●	●						20	5	0°	4°
SGM4-030-4L	4	L	4	0.3	●	●	●	●						20	5	4°	0°
SGM5-030	5	N	5	0.3	●	●	●	●	●	●				25	5.5	0°	0°
SGM6-030	6	N	6	0.3	●	●	●	●	●	●				25	5.5	0°	0°
SGM8-040	8	N	8	0.4	●		●		●	●				30	6.7	0°	0°

● : Line up

External deep grooving and parting

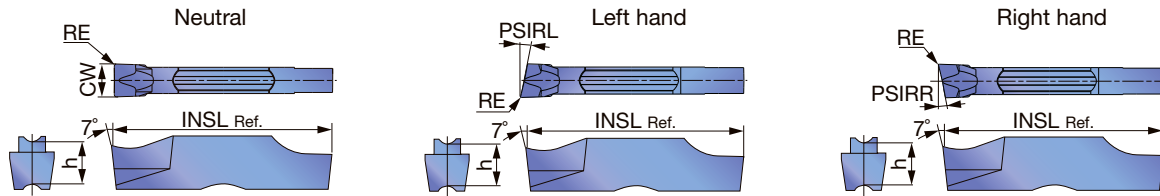

P	Steel	★	☆	★	☆	★								
M	Stainless	★	☆	★	★	★								
K	Cast iron	★		★	☆	★		☆						
N	Non-ferrous							☆						
S	Superalloys	★	☆	★				★						
H	Hard materials													

★ : First choice
☆ : Second choice

Designation	Seat size	HAND	CW±0.05	RE	Coated					Uncoated		INSL	h	PSIRL	PSIRR
					AH7025	AH725	AH8005	GH130	AH6235	KS05F					
SGS2-020	2	N	2	0.2	●	●	●	●	●	●		20	5	0°	0°
SGS2-020-6R	2	R	2	0.2	●	●	●	●	●			20	5	0°	6°
SGS2-020-6L	2	L	2	0.2	●	●	●	●	●			20	5	6°	0°
SGS2-020-15R	2	R	2	0.2	●	●	●	●	●			20	5	0°	15°
SGS2-020-15L	2	L	2	0.2	●	●	●	●	●			20	5	15°	0°
SGS3-020	3	N	3	0.2	●	●	●	●	●	●		20	5	0°	0°
SGS3-020-6R	3	R	3	0.2	●	●	●	●	●			20	5	0°	6°
SGS3-020-6L	3	L	3	0.2	●	●	●	●	●			20	5	6°	0°
SGS3-002-6R	3	R	3	0.02		●	●	●	●			19.8	5	0°	6°
SGS3-002-6L	3	L	3	0.02		●	●	●	●			19.8	5	6°	0°
SGS3-020-15R	3	R	3	0.2	●	●	●	●	●			20	5	0°	15°
SGS3-020-15L	3	L	3	0.2	●	●	●	●	●			20	5	15°	0°
SGS3-002-15R	3	R	3	0.02		●	●	●	●			19.8	5	0°	15°
SGS3-002-15L	3	L	3	0.02		●	●	●	●			19.8	5	15°	0°
SGS4-030	4	N	4	0.3	●	●	●	●	●	●		20	5	0°	0°
SGS5-030	5	N	5	0.3	●	●	●	●	●	●		25	5.5	0°	0°
SGS6-030	6	N	6	0.3	●	●	●	●	●	●		25	5.5	0°	0°
SGS8-040	8	N	8	0.4	●	●	●	●	●	●		30	6.7	0°	0°

● : Line up

DGE

External grooving (for high precision)

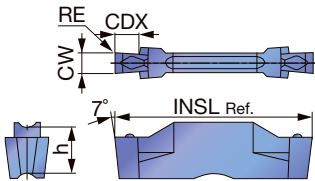

P Steel	★	☆	☆		★					
M Stainless	★	☆	★							
K Cast iron	★		☆		☆					
N Non-ferrous										
S Superalloys	★	☆								
H Hard materials										

★ : First choice
☆ : Second choice

Designation	Seat size	CW±0.02	RE	Coated			Cermet		CDX	INSL	h
				AH7025	AH725	GH130	NS9530				
DGE100-000	2	1	0		●			●	2.5	20	5
DGE130-000	2	1.3	0		●	●		●	2.5	20	5
DGE160-010	2	1.6	0.1	●	●	●		●	2.5	20	5
DGE185-010	2	1.85	0.1	●	●	●		●	3.5	20	5
DGE215-015	2	2.15	0.15	●	●	●		●	3.5	20	5

● : Line up

Caution

øDmax is limited as shown in the picture to the right according to the groove depth, G.D. Please refer to the following table.

G.D = Groove depth

Designation	Max. groove depth (mm)	øDmax (mm)				
		G.D. = 1	G.D. = 1.5	G.D. = 2	G.D. = 2.5	G.D. = 3
DGE100-000	2	∞	18.6	11.5	-	-
DGE130-000						
DGE160-010						
DGE185-010	3				8.8	7
DGE215-015						

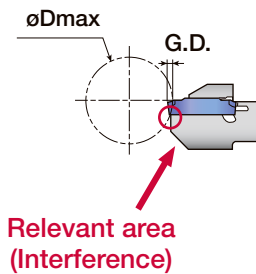

Relevant area (Interference)

DGG

External grooving (for high precision)

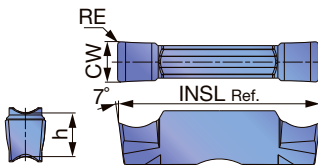

P Steel	★		★							
M Stainless	★									
K Cast iron	★		☆		☆					
N Non-ferrous						★				
S Superalloys	★					☆				
H Hard materials										

★ : First choice
☆ : Second choice

Designation	Seat size	CW±0.02	RE	Coated			Cermet		Uncoated		INSL	h
				AH7025			NS9530		KS05F			
DGG200-020	2	2	0.2	●			●		●	20	5	
DGG300-020	3	3	0.2	●			●		●	20	5	
DGG400-040	4	4	0.4	●			●		●	20	5	
DGG500-040	5	5	0.4	●			●		●	25	5.5	
DGG600-040	6	6	0.4	●			●		●	25	5.5	

● : Line up

Reference pages: Toolholders → 6-104 - 6-106, Standard cutting conditions → 6-114

DGL

External grooving and parting

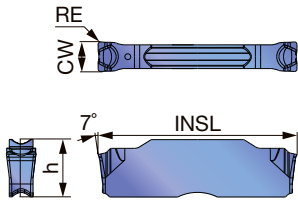

P	Steel	★	★	★					
M	Stainless	★	★	★					
K	Cast iron	★	★	★					
N	Non-ferrous								
S	Superalloys	★	★						
H	Hard materials								

★ : First choice
☆ : Second choice

Designation	Seat size	CW±0.05	RE	Coated			INSL	h
				AH7025	AH8005	AH6235		
DGL2-020	2	2	0.2	●	●	●	20	5
DGL3-025	3	3	0.25	●	●	●	20	5
DGL4-030	4	4	0.3	●	●	●	20	5
DGL5-030	5	5	0.3	●	●	●	25	5.5
DGL6-080	6	6	0.8	●	●	●	25	5.5

● : Line up

SGN

External grooving

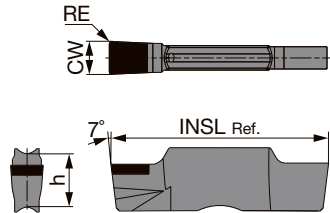

P	Steel								
M	Stainless								
K	Cast iron								
N	Non-ferrous								
S	Superalloys								
H	Hard materials	★							

★ : First choice
☆ : Second choice

Designation	Seat size	CW±0.025	RE	CBN			INSL	h	Edge prep.		
				BX360					No symbol	S	H
SGN200-020	2	2	0.2	●			20	5	○		
SGN200-020-S	2	2	0.2	●			20	5		○	
SGN200-020-H	2	2	0.2	●			20	5			○
SGN300-020	3	3	0.2	●			20	5	○		
SGN300-020-S	3	3	0.2	●			20	5		○	
SGN300-020-H	3	3	0.2	●			20	5			○
SGN400-020	4	4	0.2	●			20	5	○		
SGN400-020-S	4	4	0.2	●			20	5		○	
SGN400-020-H	4	4	0.2	●			20	5			○
SGN500-020-S	5	5	0.2	●			25	5.5		○	
SGN500-020-H	5	5	0.2	●			25	5.5			○

● : Line up

Edge preparations

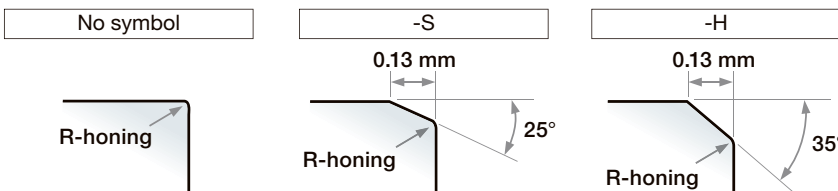

Reference pages: Toolholders → **6-104 - 6-106**, Standard cutting conditions → **6-114**

Grade

Insert

Ext. Toolholder

Int. Toolholder

Threading

Grooving

Shaper

Endmill

Drilling Tool

Technical Reference

STANDARD CUTTING CONDITIONS

ISO	Workpiece material	Hardness	Priority	Grade	Cutting speed V _c (m/min)
P	Steel S45C, SCM435, etc. C45, 34CrMo4, etc.	< 300 HB	First choice	AH7025, AH725	50 - 180
		< 300 HB	Wear resistance	T9225, AH8005	80 - 300
		< 300 HB	Impact resistance	AH6235, GH130	50 - 120
		< 300 HB	Surface quality	NS9530	80 - 220
M	Stainless steel SUS303, SUS304, etc. X10CrNiS18-9, X5CrNi18-9, etc.	< 200 HB	First choice	AH7025, AH725	50 - 120
		< 200 HB	Wear resistance	AH8005	50 - 120
		< 200 HB	Impact resistance	AH6235, GH130	50 - 120
K	Grey cast iron FC250, etc. 250, etc.	-	First choice	T515	150 - 700
		-	Impact resistance	AH8005, AH7025, AH6235, GH130	50 - 180
	Ductile cast iron FCD450, etc. 450-10S, etc.	-	First choice	T515	150 - 300
		-	Impact resistance	AH8005, AH7025, AH6235, GH130	50 - 120
N	Aluminium alloys Si < 12%	-	First choice	TH10	100 - 500
		-	First choice	KS05F	100 - 600
S	Superalloys Inconel718, etc.	< HRC 40	First choice	AH8005	20 - 60
		< HRC 40	Impact resistance	AH7025, AH725, AH6235	20 - 40
	Titanium alloys Ti-6Al-4V, etc.	< HRC 40	First choice	KS05F	20 - 100
		< HRC 40	Impact resistance	AH7025, AH725	20 - 80
H	Hardened steel SCM435, SUJ2, etc. 34CrMo4, B1, etc.	> HRC 50	First choice	BX360	80 - 150

Please see Tungaloy General catalog vol.1 **G182**, **G183** for feed: *f* (mm/rev).

CTDP.. series/Toolholder

CTDP-OH3 CUT DUO SPLASH

Direct connect coolant port 3-hole type

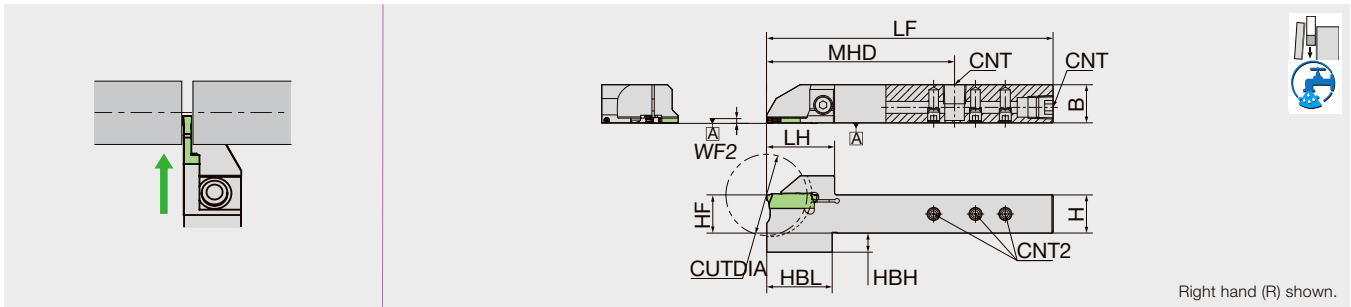

Designation	CUTDIA	H	B	LF	LH	HBH	HBL	HF	MHD	WF2	CNT	CNT2	Insert
CTDPR16-20D25-OH3	25.4	16	16	120	22	4.5	21	15.5	78.75	0.2	Rc1/8	M5	CTDP20..
CTDPR16-25D34A-OH3	34	16	16	120	28.5	8	27.5	15.5	78.8	0.2	Rc1/8	M5	CTDP25..
CTDPL16-20D25-OH3	25.4	16	16	120	22	4.5	21	16	78.75	0.2	Rc1/8	M5	CTDP20..
CTDPL16-25D34A-OH3	34	16	16	120	28.5	8	27.5	16	78.8	0.2	Rc1/8	M5	CTDP25..

SPARE PARTS

Designation	Clamp screw	Screw (for CNT)	Screw (for CNT2)	Wrench (for Clamp screw)	Wrench (for CNT2)
CTDPR/L16-20D25-OH3	LRIS-4*12	SPR1/8L	SS0505SC	LLR-25S	LW-2.5
CTDPR/L16-25D34A-OH3	CS0516LSH	SPR1/8L	SS0505SC	LW-3	LW-2.5

CTDP-OH2 CUT DUO SPLASH

Direct connect coolant port 1~2-hole type

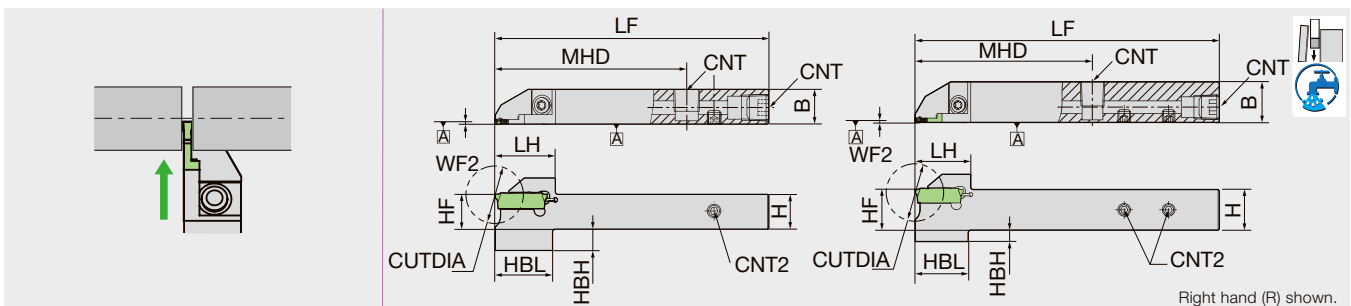

Designation	CUTDIA	H	B	LF	LH	HBH	HBL	HF	MHD	WF2	CNT	CNT2	Figure	Insert
CTDPR12-20D25-OH2	25.4	12	12	100	22	8.5	21	12	70	0.2	Rc1/8	M5	1	CTDP20..
CTDPR16-20D25-OH2	25.4	16	16	120	22	4.5	21	16	70	0.2	Rc1/8	M5	2	CTDP20..
CTDPR20-25D34A-OH2	34	20	20	120	28.5	4	27.5	20	75	0.2	Rc1/8	M5	1	CTDP25..
CTDPL12-20D25-OH2	25.4	12	12	100	22	8.5	21	12	70	0.2	Rc1/8	M5	1	CTDP20..
CTDPL16-20D25-OH2	25.4	16	16	120	22	4.5	21	16	70	0.2	Rc1/8	M5	2	CTDP20..
CTDPL20-25D34A-OH2	34	20	20	120	28.5	4	27.5	20	75	0.2	Rc1/8	M5	1	CTDP25..

SPARE PARTS

Designation	Clamp screw	Screw (for CNT)	Screw (for CNT2)	Wrench (for Clamp screw)	Wrench (for CNT2)
CTDPR/L12-20D25-OH2	LRIS-4*12	SPR1/8	SS0505SC	LLR-25S	LW-2.5
CTDPR/L16-20D25-OH2	LRIS-4*12	SPR1/8L	SS0505SC	LLR-25S	LW-2.5
CTDPR/L20-25D34A-OH2	CS0516LSH	SPR1/8	SS0505SC	LW-3	LW-2.5

CTDP CUT DUO

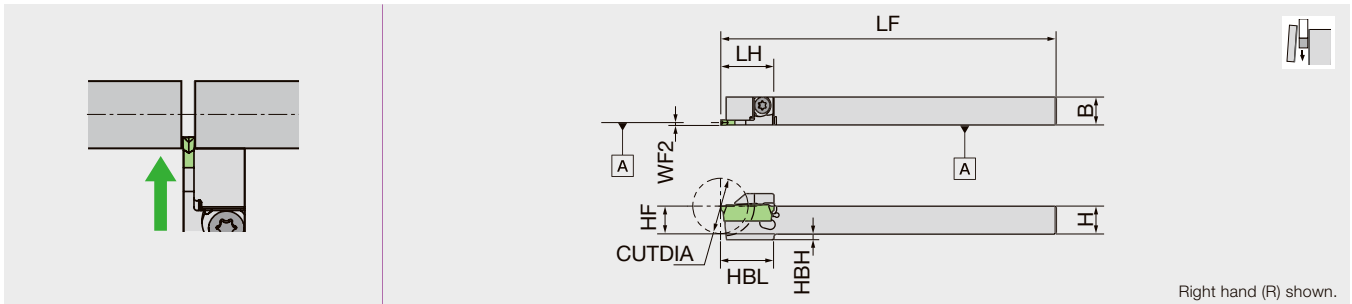

Designation	CUTDIA	H	B	LF	LH	HBH	HBL	HF	WF2	Insert
CTDPR10-20D20	20	10	10	120	19	2	19	10	0.2	CTDP20..
CTDPR12-20D20	20	12	12	120	19	-	-	12	0.2	CTDP20..
CTDPR12-20D25	25.4	12	12	120	22	-	-	12	0.2	CTDP20..
CTDPR16-20D25	25.4	16	16	120	22	-	-	16	0.2	CTDP20..
CTDPR16-20D32A	32	16	16	120	27.5	-	-	16	0.2	CTDP20..
CTDPR16-25D34A	34	16	16	120	28.5	-	-	16	0.2	CTDP25..
CTDPR2012-20D32A	32	20	12	120	29.5	-	-	20	0.2	CTDP20..
CTDPR2012-25D34A	34	20	12	120	29.5	-	-	20	0.2	CTDP25..
CTDPR20-20D32A	32	20	20	120	29.5	-	-	20	0.2	CTDP20..
CTDPR20-25D34A	34	20	20	120	29.5	-	-	20	0.2	CTDP25..
CTDPL10-20D20	20	10	10	120	19	2	19	10	0.2	CTDP20..
CTDPL12-20D20	20	12	12	120	19	-	-	12	0.2	CTDP20..
CTDPL12-20D25	25.4	12	12	120	22	-	-	12	0.2	CTDP20..
CTDPL16-20D25	25.4	16	16	120	22	-	-	16	0.2	CTDP20..
CTDPL16-20D32A	32	16	16	120	27.5	-	-	16	0.2	CTDP20..
CTDPL16-25D34A	34	16	16	120	28.5	-	-	16	0.2	CTDP25..
CTDPL2012-20D32A	32	20	12	120	29.5	-	-	20	0.2	CTDP20..
CTDPL2012-25D34A	34	20	12	120	29.5	-	-	20	0.2	CTDP25..
CTDPL20-20D32A	32	20	20	120	29.5	-	-	20	0.2	CTDP20..
CTDPL20-25D34A	34	20	20	120	29.5	-	-	20	0.2	CTDP25..

SPARE PARTS



Designation	Clamp screw	Wrench (for Clamp screw)
CTDPR/L10-20D20	LRIS-4*12	LLR-25S
CTDPR/L12-20D20	LRIS-4*12	LLR-25S
CTDPR/L12-20D25	LRIS-4*12	LLR-25S
CTDPR/L16-20D25	LRIS-4*12	LLR-25S
CTDPR/L**D32A	LRIS-5*10	LLR-28S
CTDPR/L**D34A	CS0516LSH	LW-3

Reference pages: Inserts → **6-117**

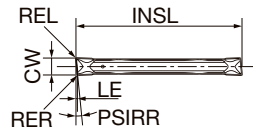

P	Steel	☆	★	★	☆
M	Stainless	★	☆	☆	☆
N	Non-ferrous	☆	☆	☆	★
S	Superalloys	★	☆	☆	☆
H	Hard materials	☆	★	☆	☆

★ : First choice
☆ : Second choice

Designation	Coated				CW	INSL	PSIRR	REL	RER	LE
	DM4	QM3	ST4	TM4						
CTDP20N	●	●	●	●	2	19.1	-	0.05	0.05	-
CTDP20N02	●	●	●	●	2	19.1	-	0.2	0.2	-
CTDP25N	●	●	●	●	2.5	21.2	-	0.05	0.05	-
CTDP25N02	●	●	●	●	2.5	21.2	-	0.2	0.2	-
CTDP20R6	●	●	●	●	2	19.1	6°	0.05	0.05	0.24
CTDP25R6	●	●	●	●	2.5	21.2	6°	0.05	0.05	0.29
CTDP20R15	●	●	●	●	2	19.1	15°	0.05	0.05	0.57
CTDP25R15	●	●	●	●	2.5	21.2	15°	0.05	0.05	0.71

● : Line up

CTWP CUT DUO EXTRA

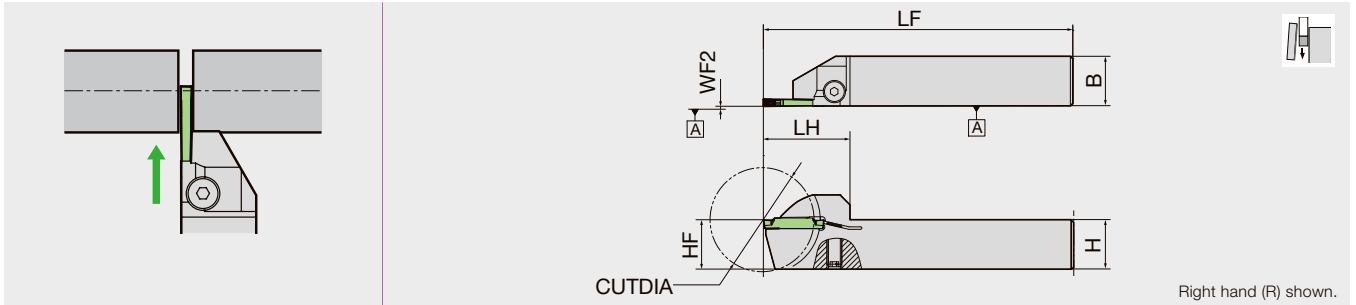

Right hand (R) shown.

Designation	CUTDIA	H	B	LF	LH	HF	WF2	Insert
CTWPR2012K-3D42	42	20	12	125	35	20	0.25	GWPFM300..
CTWPR2020K-3D42	42	20	20	125	35	20	0.25	GWPFM300..
CTWPL2012K-3D42	42	20	12	125	35	20	0.25	GWPFM300..
CTWPL2020K-3D42	42	20	20	125	35	20	0.25	GWPFM300..



SPARE PARTS

Designation	Clamp screw	Wrench (for Clamp screw)
CTWPR20**-3D42	CS0623LSHW	LW-3

INSERT

GWPFM

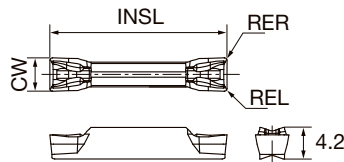

P	Steel	★
M	Stainless	★
N	Non-ferrous	★
S	Superalloys	★
H	Hard materials	☆

★ : First choice
☆ : Second choice

Designation	Coated	CW	INSL	REL	RER
	DM4				
GWPFM300N02-GT	●	3	24.5	0.2	0.2
GWPFM300N04-GT	●	3	24.5	0.4	0.4

● : Line up

External toolholders for grooving and parting

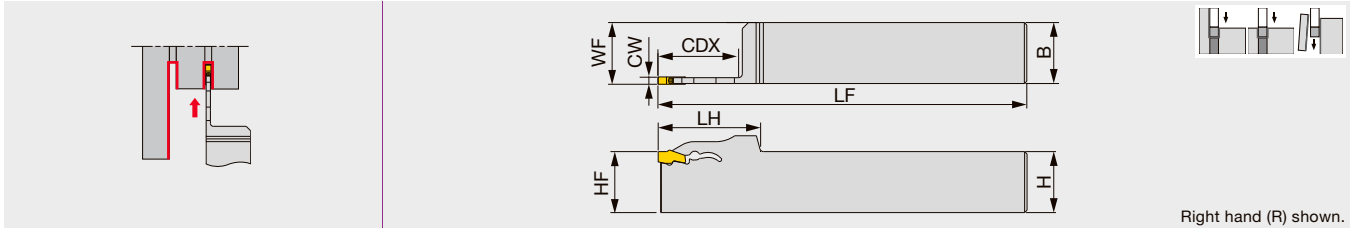

Designation	CW	CDX	Seat size	H	B	LF	LH	HF	WF
QSER/L2020-2T26	2	26	2	20	20	125	36	20	20.1
QSER/L2020-2T33	2	33	2	20	20	125	42	20	20.1
QSER/L2020-3T26	3	26	3	20	20	125	36	20	20.3
QSER/L2020-3T33	3	33	3	20	20	125	42	20	20.3
QSER/L2020-4T33	4	33	4	20	20	125	42	20	20.4

QSG

Parting-off and external grooving blade

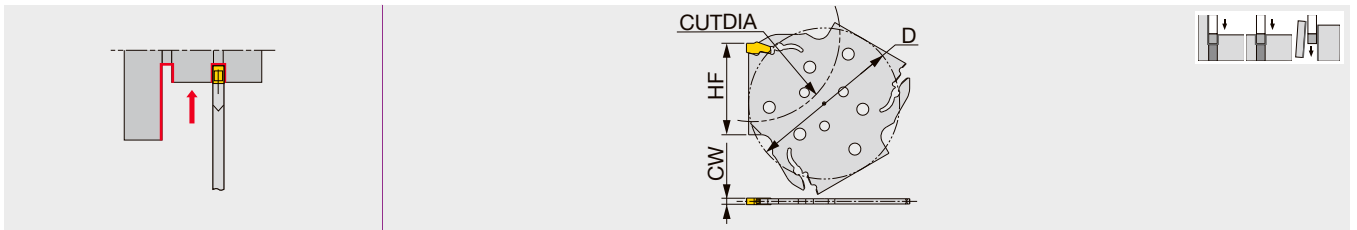

Designation	CW	Seat size	CUTDIA	HF	D
QSG52-2T	2	2	52	27	48.3
QSG82-2T	2	2	82	42	69.3
QSG52-3T	3	3	52	27	48.3
QSG82-3T	3	3	82	42	69.3
QSG52-4T	4	4	52	27	69.3
QSG82-4T	4	4	82	42	69.3

QSP

Blades for external deep grooving and parting

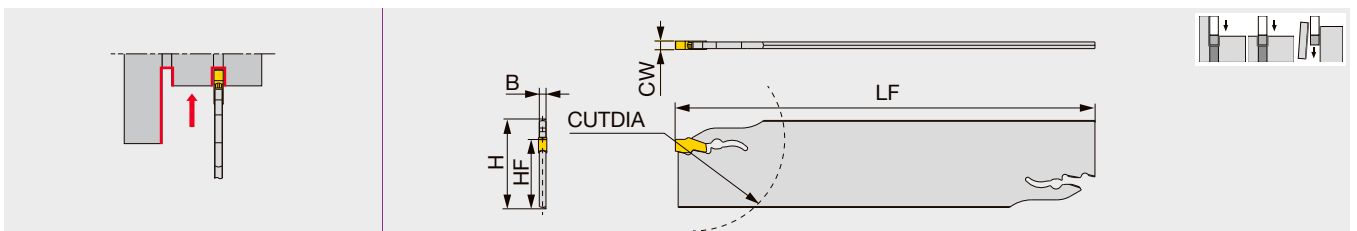

Designation	CW	CUTDIA	Seat size	H	B	LF	HF
QSP26-2D	2	50	2	26	1.8	150	21.4
QSP32-2D	2	66	2	32	1.8	150	24.8
QSP26-3D	3	75	3	26	2.4	150	21.4
QSP32-3D	3	120	3	32	2.4	150	24.8
QSP26-4D	4	80	4	26	3.2	150	21.4
QSP32-4D	4	120	4	32	3.2	150	24.9
QSP32-5D	5	120	5	32	4	150	24.9

SPARE PARTS

Designation	Wrench
QSER/L..., QSG..., QSP...	QL-39

STANDARD CUTTING CONDITIONS

ISO	Workpiece material	Hardness	Grade	Cutting speed Vc (m/min)
P	Steels C45, 34CrMo4, etc.	< 300 HB	AH7025	50 - 180
M	Stainless steel X10CrNiS18-9, etc.	< 200 HB	AH7025	50 - 120
K	Gray cast iron GG25, 250, etc.	-	AH7025	50 - 180
	Ductile cast irons GGG45, 450-10S, etc.	-	AH7025	50 - 120
S	Superalloys Inconel718, etc.	< HRC 40	AH7025	20 - 60
	Titanium alloys Ti-6Al-4V, etc.	< HRC 40	AH7025	20 - 80

Grade

Insert

Ext. Toolholder

Int. Toolholder

Threading

Grooving

Shaper

Endmill

Drilling Tool

Technical Reference

7. Shaper



SHAPER DUO

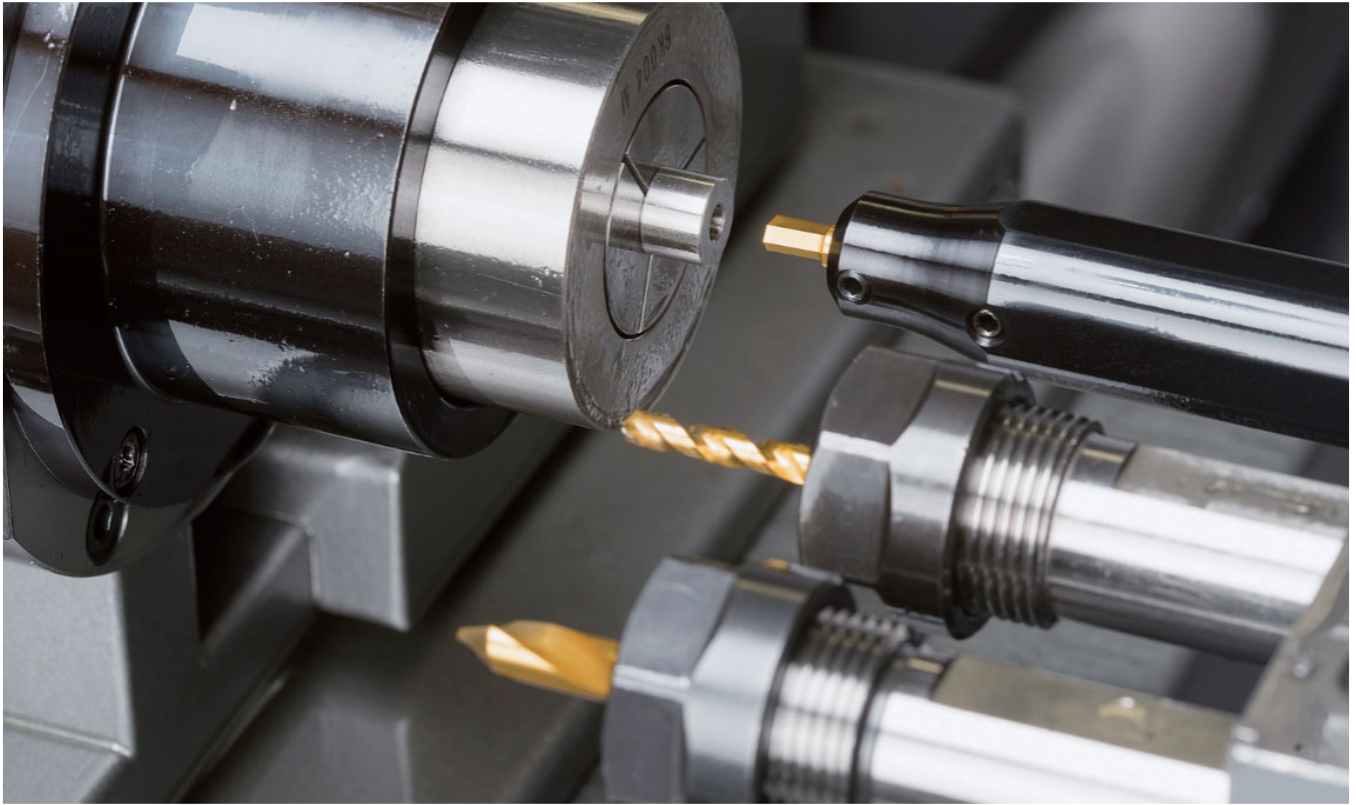

For socket hole machining on CNC automatic lathes

Hexagon, square and hexalobular socket machining can be achieved at a low cost and without any special equipment .

Wide range of socket styles and sizes can be machined by using the sub-spindle of automatic lathes.

Features

- Machine square, hexagon, and hexalobular socket holes
- Less tool pressure than Rotary-Broaching. Ideal for machining small diameter work pieces
- Wide range of socket dimensions can be machined with one size of SHAPER DUO
- Special workpieces and small quantity part runs can be machined with less tool costs

Hexalobular Socket



Hexagon Socket



Square Socket



Grade

1

Insert

2

Ext. Toolholder

3

Int. Toolholder

4

Threading

5

Grooving

6

Shaper

7

Endmill

8

Drilling Tool

9

Technical Reference

10

Features

Comparison Chart of Hexalobular Socket Machining

	Tool Pressure	Cycle Time	Tool Cost	High speed spindle	Programming	
SHAPER DUO	◎	◎	◎	Not necessary	Simple	<ul style="list-style-type: none"> No high speed spindle needed A lot less cycle time
End mill	○	×	△	Necessary	Complicated	<ul style="list-style-type: none"> Need high speed spindle Time consuming process

*Small diameter end mill driven by high-speed spindle is popular way to create Hexalobular(6-lobe) socket.

It has some flexibility but needs high speed spindle unit and it is a time consuming process.

*SHAPER DUO can make Hexalobular(6-lobe) socket faster and simpler.

Comparison Chart of HEX Socket Machining

	Tool Pressure	Cycle Time	Tool Cost	High speed spindle	
SHAPER DUO	◎	△ ※ Can be off-set by over-wrapping operation	○	◎	<ul style="list-style-type: none"> Less tool pressure-especially on small diameter parts One size can cover several socket sizes
Rotary-broaching	△	○	×	○	<ul style="list-style-type: none"> Need to have tools for each socket size

*Rotary-broaching is an efficient way to machine a Hexagon socket.

But tool pressure is high and often times it pushes part too hard.

*SHAPER DUO system enables less tool pressure and provides better tolerance with less cost.

Example of machining Hexagon socket

SHAPER DUO has better tool life compared to the competitor which has an immediate worn and rounded cutting edge.

NTK's special grinding process and TM4 grade enable to:

- ① Keep good corner edge sharpness and long tool life
- ② Provide better tolerance and accuracy
- ③ Provide better surface quality

Work materials	SUS303			
Feed	2,000 mm/min		TM4 SSP030N1940H	10,000 pcs / corner
Depth of cut (ap)	Roughing 0.025mm		Competitor's carbide inserts	300 pcs / corner
	Finishing 0.005mm			
Coolant	WET			

SHAPER DUO

INSERT BAR Hexalobular Socket (6-LOBE hole)

SSP-H

Hexagon Socket

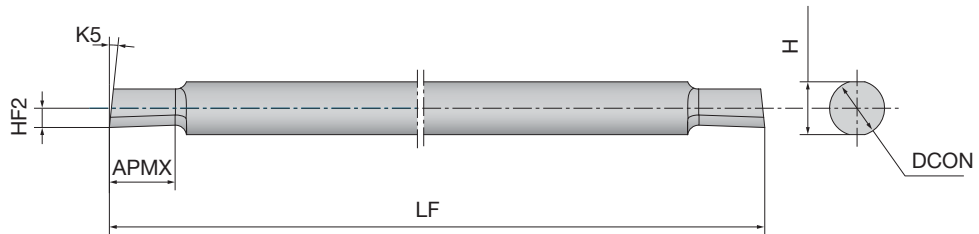
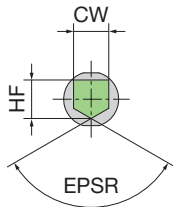

P	Steel	★
M	Stainless	★
N	Non-ferrous	★
S	Superalloys	
H	Hard materials	

★ : First choice
☆ : Second choice

Designation	Coated	Base AF	AF range	EPSR	DCON	APMX	H	LF	CW	HF	HF2	K5
	TM4											
SSP020N06515H	●	1	1 - 1.1	120°	2	1.5	1.8	50	0.65	0.7	0.35	15°
SSP020N07018H	●	1.1	1.1 - 1.2	120°	2	1.8	1.8	50	0.7	0.8	0.4	15°
SSP020N07518H	●	1.2	1.2 - 1.3	120°	2	1.8	1.8	50	0.75	0.9	0.45	15°
SSP020N08020H	●	1.3	1.3 - 1.4	120°	2	2	1.8	50	0.8	1	0.5	15°
SSP020N1130H	●	1.5	1.4 - 1.9	120°	2	3	1.8	50	1.1	0.9	0.45	6°
SSP020N1430H	●	2	1.8 - 2.5	120°	2	3	1.8	50	1.4	1.2	0.6	6°
SSP030N1940H	●	3	2.3 - 3.5	120°	3	4	2.8	50	1.9	1.5	0.75	6°
SSP040N2450H	●	4	3.3 - 4.5	120°	4	5	3.8	60	2.4	2.5	1.25	6°
SSP050N3260H	●	5	4.3 - 6.1	120°	5	6	4.8	70	3.2	3.3	1.65	6°
SSP060N42120H	●	6	5.3 - 8.1	120°	6	12	5.6	80	4.2	4	2	6°
SSP080N62160H	●	8	7.3 - 12.1	120°	8	16	7.6	80	6.2	4.9	2.45	6°

● : Line up

Grade 1
Insert 2
Ext. Toolholder 3
Int. Toolholder 4
Threading 5
Grooving 6
Shaper 7
Endmill 8
Drilling Tool 9
Technical Reference 10

Hexalobular Socket

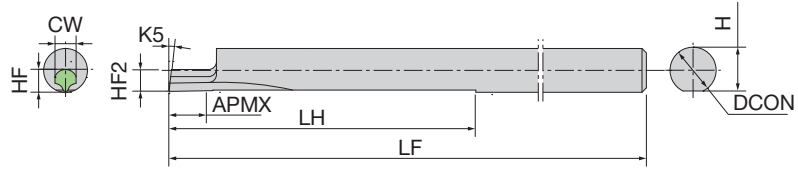
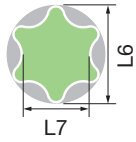

P	Steel	★	
M	Stainless	★	
N	Non-ferrous	★	
S	Superalloys		
H	Hard materials		

★ : First choice
☆ : Second choice

Designation	Coated	Socket size	Socket number	L6	L7	Recommended Pilot bore Dia.	DCON	APMX	H	LF	LH	CW	HF	HF2	K5
	TM4														
SSP050N25T06	●	T6	6	1.75	1.27	1.15	5	2.5	4.75	70	35	1.2	1.09	2.4	6°
SSP050N31T07	●	T7	-	-	-	1.38	5	3.1	4.75	70	35	1.4	1.29	2.4	6°
SSP050N36T08	●	T8	8	2.4	1.75	1.62	5	3.6	4.75	70	35	1.6	1.5	2.4	6°
SSP050N41T10	●	T10	10	2.8	2.05	1.92	5	4.1	4.75	70	35	1.8	1.7	2.4	6°
SSP050N43T15	●	T15	15	3.35	2.4	2.3	5	4.3	4.75	70	35	2.2	2.1	2.4	6°
SSP050N46T20	●	T20	20	3.95	2.85	2.71	5	4.6	4.75	70	35	2.6	2.5	2.4	6°
SSP050N50T25	●	T25	25	4.5	3.25	3.13	5	5	4.75	70	35	3	2.9	2.4	6°
SSP050N55T27	●	T27	-	-	-	3.52	5	5.5	4.75	70	35	3.4	3.3	2.4	6°
SSP050N55T30	●	T30	30	5.6	4.05	3.91	5	5.5	4.75	70	35	3.8	3.7	2.4	6°

● : Line up

SSP-S

Square Socket

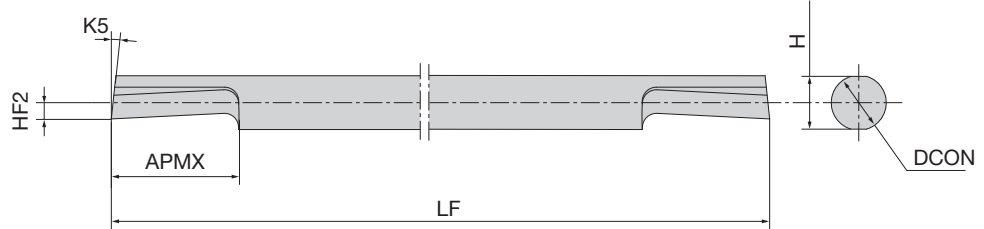
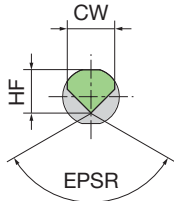
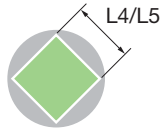

P	Steel	★
M	Stainless	★
N	Non-ferrous	★
S	Superalloys	
H	Hard materials	

★ : First choice
☆ : Second choice

Designation	Coated	Base AF	AF range	EPSR	DCON	APMX	H	LF	CW	HF	HF2	K5
	TM4											
SSP020N1740S	●	2	2 - 2.3	90°	2	4	1.8	50	1.7	1.6	0.7	6°
SSP025N1940S	●	2.5	2.3 - 2.6	90°	2.5	4	2.3	50	1.95	1.8	0.65	6°
SSP030N2260S	●	3	2.6 - 3	90°	3	6	2.8	50	2.2	2.05	0.65	6°
SSP035N2760S	●	3.5	2.9 - 3.7	90°	3.5	6	3.3	60	2.7	2.25	0.6	6°
SSP040N3380S	●	4	3.7 - 4.5	90°	4	8	3.8	60	3.35	3.05	1.15	6°
SSP050N39100S	●	5	4.5 - 5.3	90°	5	10	4.8	70	3.9	3.95	1.55	6°
SSP060N47120S	●	6	5.3 - 6.5	90°	8	12	5.6	80	4.75	4.5	1.7	6°
SSP080N58160S	●	8	6.5 - 8	90°	8	16	7.6	80	5.8	5.5	1.7	6°

● : Line up

Grade
Insert
Ext. Toolholder
Int. Toolholder
Threading
Grooving
Shaper
Endmill
Drilling Tool
Technical Reference



Machining Procedure

① Center drilling

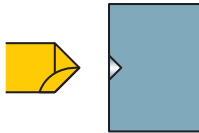

Make a center hole which is smaller than pilot hole drill.

② Drilling (Pilot hole)

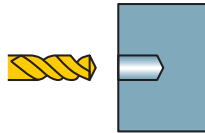

Select a drill with same or smaller (0 ~ -0.1mm) dia. as AF and machine a bit deeper because burrs may cause chipping on shaper insert

③ Shaper tool

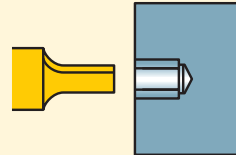

Machine socket rotating 60 degrees 6 times

④ Chamfering

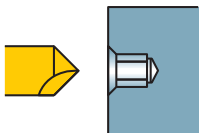

Chamfer with the same pilot hole drill as ①

⑤ Deburring

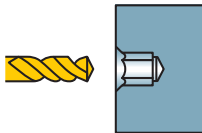

Finish and deburr with the same drill as in process ②
☆Reduce cutting conditions due to heavy interruption

SHAPER DUO Process Chart -Hexalobular-

Socket Size	Tool	Pilot bore Dia. (mm)	Starting“ X” position (mm)	Final“ X” position (mm)	Number of passes		Estimated cycle time*		
					Roughing pass 0.025mm	Finishing pass 0.005mm	ISO10664		Shaper process ③
							Standard depth of Hexalobular hole (mm)	Whole process ①-⑤	
T6	SSP050N25T06	1.15	1.14	1.75	13	1	1.82	51 sec	23.2 sec
T7	SSP050N31T07	1.38	1.35	2.06	15	1	2.44	59 sec	28.2 sec
T8	SSP050N36T08	1.62	1.59	2.4	17	1	3.05	67 sec	33.8 sec
T10	SSP050N41T10	1.92	1.89	2.8	19	1	3.56	75 sec	39.5 sec
T15	SSP050N43T15	2.3	2.29	3.35	22	1	3.81	84 sec	46.2 sec
T20	SSP050N46T20	2.71	2.69	3.95	26	1	4.07	94 sec	55.4 sec
T25	SSP050N50T25	3.13	3.09	4.5	29	1	4.45	105 sec	63.8 sec
T27	SSP050N55T27	3.52	3.51	5.07	32	1	4.7	115 sec	71.8 sec
T30	SSP050N55T30	3.91	3.89	5.6	35	1	4.95	125 sec	80.2 sec

*Using carbide drills *Shaper cutting conditions Feed: 3000mm/min Depth of cut : Roughing 0.025mm / Finishing 0.005mm

SHAPER DUO Process Chart -Hexagonal-

HEX Standard	Tool	Pilot bore Dia. (mm)	Starting“ X” position (mm)	Final“ X” position (mm)	Number of passes		Estimated cycle time*		
					Roughing pass 0.025mm	Finishing pass 0.005mm	ISO10664		Shaper process ③
							Standard depth of Hexalobular hole (mm)	Whole process ①-⑤	
HEX 1.5	SSP020N1130H	1.5	1.47	1.73	6	1	2	39 sec	14 sec
HEX 2.0	SSP020N1430H	2	1.95	2.31	8	1	2.5	44 sec	16 sec
HEX 2.5	SSP030N1940H	2.5	2.48	2.89	9	1	3	50 sec	20 sec
HEX 3.0	SSP030N1940H	3	2.95	3.46	11	1	3.5	55 sec	23 sec
HEX 4.0	SSP040N2450H	4	3.96	4.62	14	1	5	73 sec	33 sec
HEX 5.0	SSP050N3260H	5	4.96	5.77	17	1	6	90 sec	46 sec
HEX 6.0	SSP060N42120H	6	5.97	6.93	20	1	8	117 sec	63 sec
HEX 8.0	SSP080N62160H	8	7.98	9.24	26	1	10	155 sec	92 sec

*Using carbide drills *Shaper cutting conditions Feed: 3000mm/min Depth of cut : Roughing 0.025mm / Finishing 0.005mm

Recommended cutting conditions

Feed : F1000 - F4000 mm/min Depth of Cut : Roughing 0.025mm / Finishing 0.005mm

Precautions when replacing the insert bar

The tool nose position dimensions (HF2) vary. Check the dimensions of the cutting tool after changing tools or indexing insert bar.

SHAPER DUO Set-up Instructions -Hexagonal

Outside machine

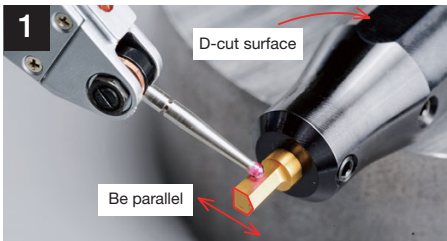

- Set the insert bar in the sleeve and check the parallelism of the flat portion of the sleeve and the insert bar.
- Minimize the overhang of the insert.

Inside machine

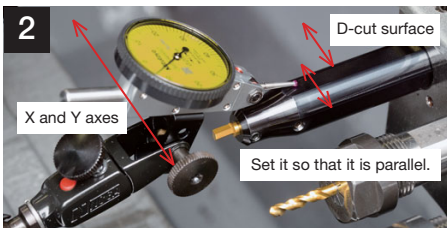

- Set the sleeve into the tool post and make sure the sleeve is set parallel.
- Minimize sleeve overhang.



- Increase the number of machining passes with smaller depth of cut if the insert chips with large depth of cut. (0.025mm×5pass is recommended)
No chamfering process is required for measuring purpose.
- Measure the length of both [a] and [b] with comparator or magnifier.
- Adjust centerline height by rotating the sleeve until you get the same length for [a] and [b].(The difference should be less than 0.02mm)
*If the straight is not seen with increased passes, you need to reset the insert and the sleeve. Please make sure both the insert and the sleeve are set up correctly.

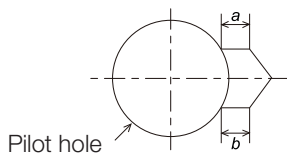

4 Machine Hexagonal shape

*Run full HEX machining program.

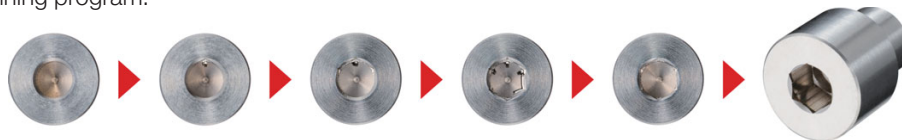

Machining hexalobular shape is basically the same as hexagon socket

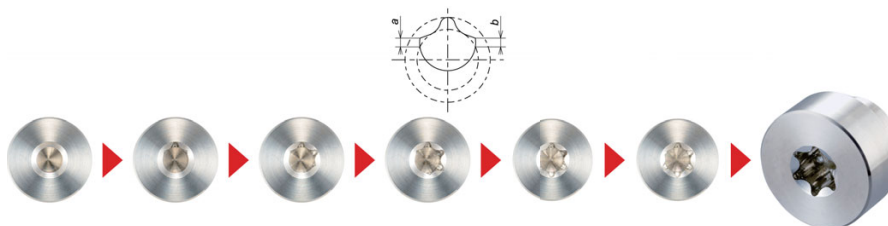

Important Note for Insert Set-up

When using the STICK DUO HYPER series, it is important that the insert is installed and oriented so the bar flat is lined up with the clamp screws. If installed in the wrong position, insert edge chipping may occur due to interference with the positioning and clamping screws. See diagram below.



Square



Hexagon



Square

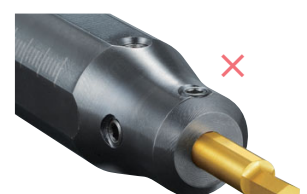

Hexagon

Grade

Insert

Ext. Toolholder

Int. Toolholder

Threading

Grooving

Shaper

Endmill

Drilling Tool

Technical Reference

Machining Program Code Explanation

Important: The programming codes and values will depend on the machine brands. For details, please contact the machine manufacturer.

Example machining piece : Hexagon socket dimensions
 : AF 3.0mm, Diagonal 3.46mm, Socket depth 3.5mm, Pilot drill diameter ϕ 3.0mm
 DOC : Roughing 0.025mm / Finishing 0.005mm
 Insert bar : TM4 SSP030N1940H

Programming tips

• Make a program considering final "X" position.

- #1 Final "X" position : 3.46mm (AF)
- #2 Finishing position of roughing : $3.46 - 0.01$ (Finishing) = 3.45mm
- #3 Calculate total DOC for roughing : $3.45 - 3.0$ (Pilot hole) = 0.45mm
- #4 Determine number of cuts : $0.45 \div 0.05$ (5 DOC for Dia.) = 9.0 + (2 round down to whole number and add "2" for program adjustment)
 → Roughing sequence runs 11 times
- #5 Set starting point : $3.45 - (0.05 \times (11 - 1)) =$ 2.95mm : must subtract by "1" for program adjustment

Main program
☆ : Rear spindle rotation stop
☆ : Back spindle indexing 0°①
T0000 (Shaper)
G50 U1.5②
G0 X2.95 Z-2.0T OO call③
☆ : Sub-program cal (OOO①) Repeat 11 times④
☆ : Sub-program cal (OOO②)⑤
☆ Back spindle indexing 60°①
G0 X2.95 Z-2.0
☆ : Sub-program cal (OOO①) Repeat 11 times④
☆ : Sub-program cal (OOO②)⑤
☆ : Back spindle indexing 120°①
G0 X2.95 Z-2.0
☆ : Sub-program cal (OOO①) Repeat 11 times④
☆ : Sub-program cal (OOO②)⑤
☆ : Back spindle indexing 180°①
G0 X2.95 Z-2.0
☆ : Sub-program cal (OOO①) Repeat 11 times④
☆ : Sub-program cal (OOO②)⑤
☆ : Back spindle indexing 240°①
G0 X2.95 Z-2.0
☆ : Sub-program cal (OOO①) Repeat 11 times④
☆ : Sub-program cal (OOO②)⑤
☆ : Back spindle indexing 300°①
G0 X2.95 Z-2.0
☆ : Sub-program cal (OOO①) Repeat 11 times④
☆ : Sub-program cal (OOO②)⑤
☆ : Spindle indexing release
G0 Z-2.0
G50 U-1.5
G0 U0 W0 T0
M1

Sub-program ①
N0000① (Roughing)
G4 U0.02⑥
G98 G1 Z3.5 F3000⑦
G4 U0.02
U-0.2 W-0.018⑧
G4 U0.02
G0 Z-2.0
G4 U0.02
U0.25⑨
M99

Sub-program ②
N0000② (Finishing)
G98 G1 X3.46 Z-2.0 F1000
G4 U0.02
Z3.5 F3000
G4 U0.02
U-0.2 W-0.018
G4 U0.02
G0 Z-2.0
M99

- ④ = Go to the Sub-Program #1.
 - Sequence runs 11 times. First cutting point X2.95 and final cutting point X3.45, with 0.05 DOC (for diameter) each time.
- ⑤ = Go to the Sub-Program #2, for finishing sequence.
 - Finishing operation with 0.005mm DOC (X 3.46) is recommended for better surface finish.
- ⑥ = Specify dwell time. This allows the program and machine to stay synchronized.
- ⑦ = Cut into part 3.5mm. F3000 is recommended feed to be used for most materials; including Titanium Alloy and Stainless Steel.
- ⑧ = This code backs off the tool with an angle greater than K5 degrees (10 degrees used in example). See page W4.

☆ : Enter the program corresponding to your machine.

- ① = Index the sub-spindle 6 times in 60 degree increments.
- ② = Specify the coordinate system shift command (in X axis direction) for the tool.
 - * A positive direction shift is recommended for easier programming.
 - [2 x HF2 ; where HF2 is tool dimension located in the catalog].
- ③ = Execute the positioning of the tool.
 - X position should be smaller than pilot drill diameter.
 - Z position should be offset 2.0 mm from material to achieve program feed rate.

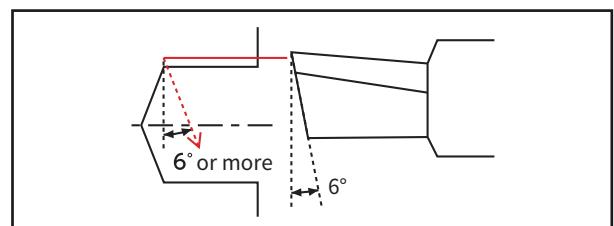

⑨ = Return to the X position + 0.05mm (the DOC for diameter).

Hexagon Socket Programming Code Examples from Machine Builders in Metric

Important: The programming codes and values will depend on the machine brands. For details, please contact to the machine manufactures.

Example machining piece : Hexagon socket dimensions
 : AF 3.0mm, Diagonal 3.46mm, Socket depth 3.5mm, Pilot drill diameter ϕ 3.0mm
 DOC : Roughing 0.025mm / Finishing 0.005mm
 Insert bar : TM4 SSP030N1940H

| CITIZEN

Main program	
M25	
M78 S0①	
T○○○○ (Shaper)	
G50 U1.5②	
G0 X2.95 Z-2.0 T○○③	
M98 P2100 L11④	
M98 P2200⑤	
M78 S60①	} 《A》
G0 X2.95 Z-2.0	
M98 P2100 L11	
M98 P2200	
Repeat 《A》 at S120, S180, S240, S300 with indexing at 60° increments	
M20	
G0 Z-2.0	
G50 U-1.5	
G0 U0 W0 T0	
M1	

| STAR

Main program	
M25	
T○○○○ (Shaper)	
G50 U1.5②	
M8	
G0 X2.95 Z-2.0 C0 T○○①③	
M98 P2100 L11④	
M98 P2200⑤	
G0 C60.0①	} 《A》
G0 X2.95 Z-2.0	
M98 P2100 L11	
M98 P2200	
Repeat 《A》 at S120, S180, S240, S300 with indexing at 60° increments	
G0 Z-2.0	
G50 U-1.5	
G0 T0	
G28 W0	
M1	

| TSUGAMI

Main program	
M105	
M150	
G28 H0①	
M182	
T○○○○ (Shaper)	
G50 U1.5②	
G0 X2.95 Z2.0 T○○③	
M98 P2100 L11④	
M98 P2200⑤	
M183	
G0 C60①	} 《A》
M182	
G0 X2.95 Z2.0	
M98 P2100 L11	
M98 P2200	
Repeat 《A》 at S120, S180, S240, S300 with indexing at 60° increments	
M183	
M151	
G0 Z2.0	
G50 U-1.5	
G0 U0 W0 T0	
M1	

Sub-program ①	
N2100 (Roughing)	
G4 U0.02.....⑥	
G98 G1 Z3.5 F3000⑦	
G4 U0.02	
U-0.2 W-0.018⑧	
G4 U0.02	
G0 Z-2.0	
G4 U0.02	
U0.25⑨	
M99	

Sub-program ①	
O2100 (Roughing)	
G4 U0.02.....⑥	
G98 G1 Z3.5 F3000⑦	
G4 U0.02	
U-0.2 W-0.018⑧	
G4 U0.02	
G0 Z-2.0	
G4 U0.02	
U0.25⑨	
M99	

Sub-program ①	
O2100 (Roughing)	
G4 U0.02.....⑥	
G98 G1 Z-3.5 F3000⑦	
G4 U0.02	
U-0.2 W0.018⑧	
G4 U0.02	
G0 Z2.0	
G4 U0.02	
U0.25⑨	
M99	

Sub-program ②	
N2200 (Finishing)	
G98 G1 X3.46 Z-2.0 F1000	
G4 U0.02	
Z3.5 F3000	
G4 U0.02	
U-0.2 W-0.018	
G4 U0.02	
G0 Z-2.0	
M99	

Sub-program ②	
O2200 (Finishing)	
G98 G1 X3.46 Z-2.0 F1000	
G4 U0.02	
Z3.5 F3000	
G4 U0.02	
U-0.2 W-0.018	
G4 U0.02	
G0 Z-2.0	
M99	

Sub-program ②	
O2200 (Finishing)	
G98 G1 X3.46 Z2.0 F1000	
G4 U0.02	
Z-3.5 F3000	
G4 U0.02	
U-0.2 W0.018	
G4 U0.02	
G0 Z2.0	
M99	

Grade
 1
 Insert
 2
 Ext. Toolholder
 3
 Int. Toolholder
 4
 Threading
 5
 Grooving
 6
 Shaper
 7
 Endmill
 8
 Drilling Tool
 9
 Technical Reference
 10

Troubleshooting

Problem: Step on sides

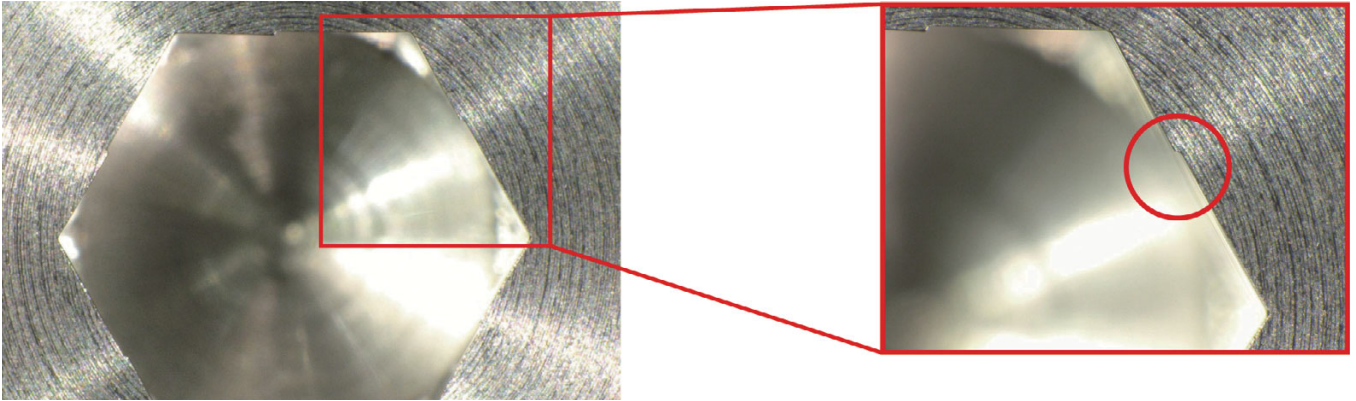

Cause: Incorrect tool set-up (Center-line shift)

Solution: Machine one angle and make sure both [a] and [b] lengths are identical, rotating the sleeve if necessary

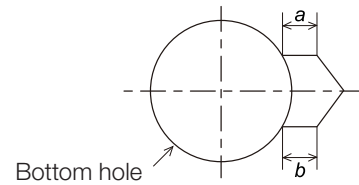

Problem: Wall dented

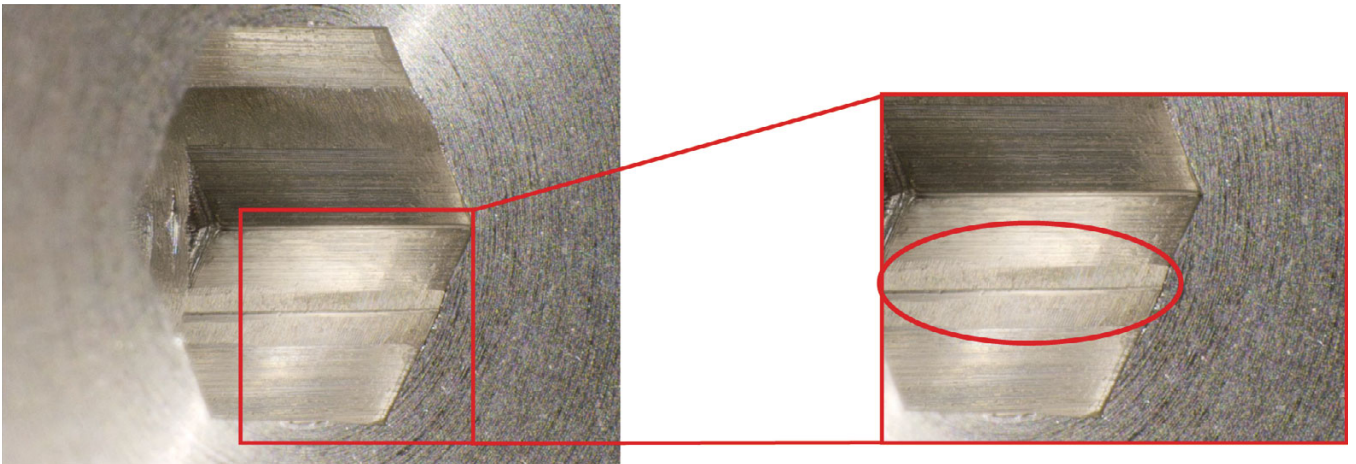

Cause: Pilot hole remaining

Solution: Need pilot hole tool's offset

Problem: Wall tapered

Solution:

- Smaller depth of cut
- Less tool overhang

Problem: Chuck is slipping / Insert chipped

Solution:

- Run at 3000 mm/min feed rate
- Smaller depth of cut

-
- 3000 mm/min feed rate can cover most materials including Titanium alloy and Stainless steel.
 - Too slow or too fast of a feed rate may cause excessive tool pressure for the workpiece and tool.

8. Endmill



Endmill



TUNGFRECE

Mini square shoulder milling cutters for high productivity

 $\varnothing 8 - \varnothing 12$ mm

8-4 -

P M N S H



SOLIDMEISTER

Solid endmill for a wide variety of applications

$\varnothing 0.4$ mm - $\varnothing 12$ mm

8-10 -

P M N S H



TUNGMEISTER

Endmills with exchangeable heads for reduced tool change time

$\varnothing 6$ mm - $\varnothing 20$ mm

8-2, 8-36 -

P M N S H

Optimal tool combination for maximum productivity

Significantly reduced tool indexing time improves machining efficiency



1 Wide range of geometries

45 kinds of geometries are available. The head indexing is easy and highly accurate with the precision thread.

2 Three kinds of shank material

Users can choose the most suitable combination according to the machining parameters, length and application required.

Steel: For general purpose

Carbide: For highly accurate machining due to excellent rigidity

Tungsten: Reduced chattering due to high vibration damping capacity



Straight shank & neck



Straight shank & taper neck



Straight shank & neck (carbide)



Straight (for slotting)



High rigidity shank



ER collet



Adaptor for TungFlex

No setup time

Machine downtime is decreased considerably. Simplified setup since only the head is indexed.

Increases productivity by 90%

Exchange time / Piece

TUNGMEISTER

less than 1 minute

Solid endmill

10 minutes

High accuracy and repeatability

Repeatability and accuracy are maintained due to full contact of both taper and face.

Head exchange accuracy

Height: $\pm 20 \mu\text{m}$

Run out: $\leq 20 \mu\text{m}$

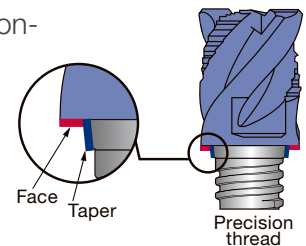



VEH, VEE, VED

Extensive tool diameter range from 5 to 32 mm

Covers a broad range of applications from precision machining to large size parts.

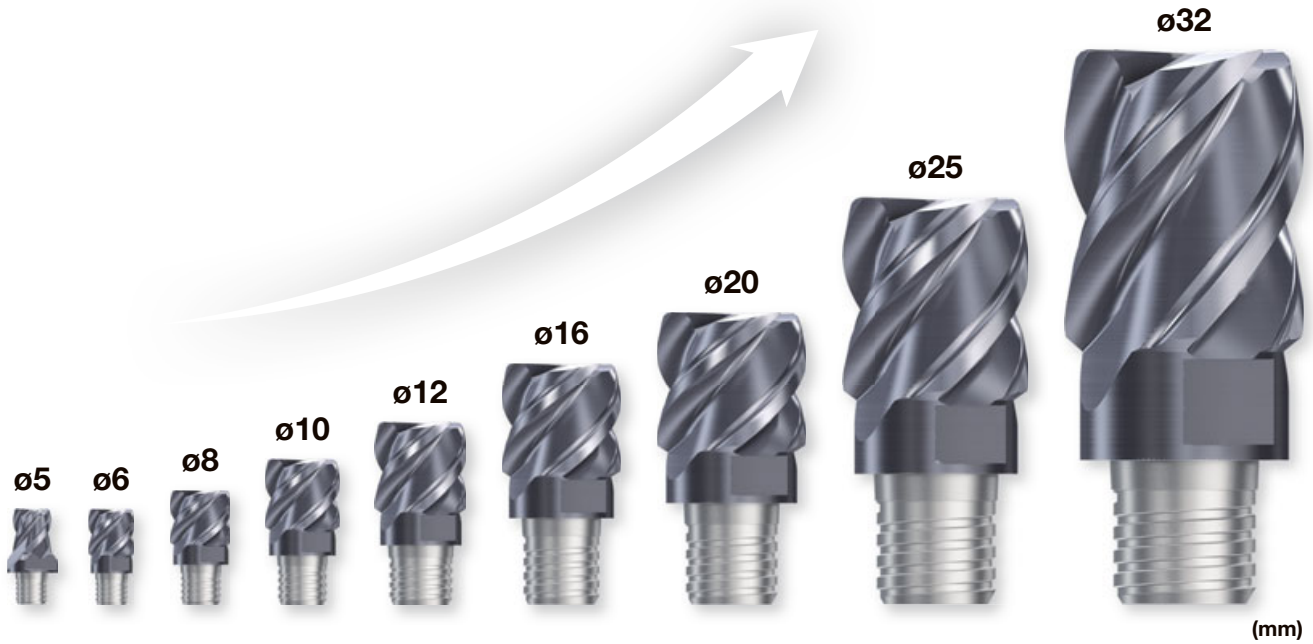

Grade 1

Insert 2

Ext. Toolholder 3

Int. Toolholder 4

Threading 5



VMT

Threading

Thread milling heads

With multiple teeth for ISO, Unified, and Whitworth threads



ISO metric
VMT***IS



Unified
VMT***UN



Whitworth
VMT***W

Grooving 6

Shaper 7



VTR

Threading

Thread milling heads

With single tooth for ISO and Whitworth threads



ISO metric
60° partial profile
VTR***IS



Whitworth
55° partial profile
VTR***W

Endmill 8

Drilling Tool 9

Technical Reference 10

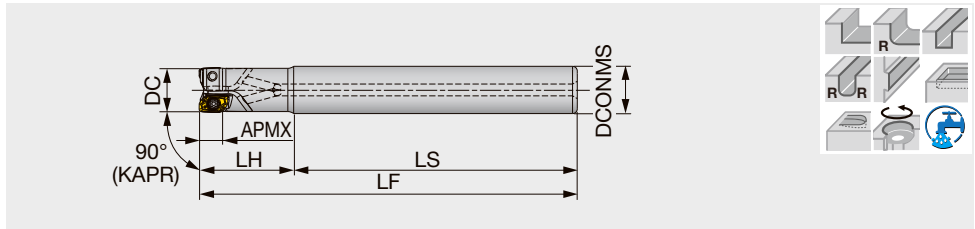

Designation	APMX	DC	CICT	DCONMS	LS	LH	LF	WT(kg)	Air hole	Insert
EPAV04M006C06.0R01	4	6	1	6	48	12	60	0.01	With	AVMT04...
EPAV04M008C08.0R02	4	8	2	8	48	12	60	0.02	With	AVMT04...
EPAV04M008C08.0R02L	4	8	2	8	60	20	80	0.03	With	AVMT04...
EPAV06M008C10.0R01	6	8	1	10	60	20	80	0.04	With	AVGT06...
EPAV04M010C10.0R02	4	10	2	10	60	20	80	0.04	With	AVMT04...
EPAV04M010C10.0R03	4	10	3	10	60	20	80	0.04	With	AVMT04...
EPAV04M010C10.0R02L	4	10	2	10	65	35	100	0.05	With	AVMT04...
EPAV06M010C10.0R02	6	10	2	10	60	20	80	0.04	With	AVGT06...
EPAV06M010C10.0R02L	6	10	2	10	65	35	100	0.06	With	AVGT06...
EPAV06M010C08.0R02L	6	10	2	8	80	20	100	0.04	With	AVGT06...
EPAV04M012C12.0R03	4	12	3	12	60	20	80	0.06	With	AVMT04...
EPAV04M012C12.0R04	4	12	4	12	60	20	80	0.06	With	AVMT04...
EPAV04M012C12.0R03L	4	12	3	12	85	35	120	0.09	With	AVMT04...
EPAV06M012C12.0R02	6	12	2	12	60	20	80	0.06	With	AVGT06...
EPAV06M012C12.0R03	6	12	3	12	60	20	80	0.06	With	AVGT06...
EPAV06M012C12.0R02L	6	12	2	12	85	35	120	0.09	With	AVGT06...
EPAV06M012C10.0R02L	6	12	2	10	100	20	120	0.07	With	AVGT06...
EPAV06M012C10.0R03	6	12	3	10	60	20	80	0.04	With	AVGT06...
EPAV06M014C12.0R03	6	14	3	12	60	20	80	0.07	With	AVGT06...
EPAV06M014C12.0R03L	6	14	3	12	120	20	140	0.11	With	AVGT06...
EPAV04M016C16.0R04	4	16	4	16	70	20	90	0.12	With	AVMT04...
EPAV04M016C16.0R05	4	16	5	16	70	20	90	0.12	With	AVMT04...
EPAV04M016C16.0R04L	4	16	4	16	105	35	140	0.19	With	AVMT04...
EPAV06M016C16.0R03	6	16	3	16	70	20	90	0.12	With	AVGT06...
EPAV06M016C16.0R04	6	16	4	16	70	20	90	0.12	With	AVGT06...
EPAV06M016C16.0R03L	6	16	3	16	105	35	140	0.20	With	AVGT06...

Approach angle

7°-25°

41°-45°

60°-70°

85°-88°

90°

Others

SPARE PARTS



Designation	Clamping screw	Lubricant	Wrench
EPAV04M006C06.0R01	CSPB-1.8L3.3	M-1000	IP-6DB
EPAV04M008... - EPAV04M016...	CSPB-1.8L3.6	M-1000	IP-6DB
EPAV06M...	CSPB-2H	M-1000	IP-6DB

Recommended clamping torque:
 CSPB-1.8L3.3, CSPB-1.8L3.6 = 0.5 N·m, CSPB-2H = 0.7 N·m, CSPB-2.5, CSPB-2.5S = 1.3 N·m

HPAV06-S

Square shoulder endmill, modular type (TungMeister), with screw clamp system

GAMP = +6.9°~ +7.6°, GAMF = -35.2°~ -32.4°

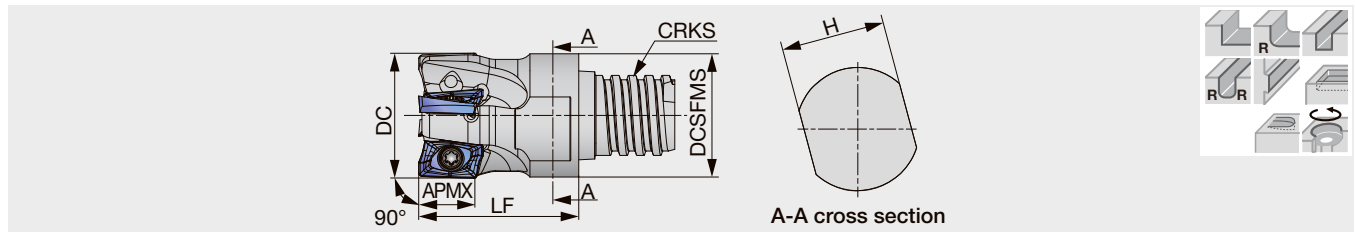

Designation	APMX	DC	CICT	LF	H	DCSFMS	CRKS	WT(kg)	Insert
HPAV06M010S05R02	6	10	2	10	8	8	S05	0.01	AVGT06...
HPAV06M010S06R02	6	10	2	16	8	9.8	S06	0.01	AVGT06...
HPAV06M012S08R02	6	12	2	18	10	11.7	S08	0.02	AVGT06...
HPAV06M012S08R03	6	12	3	18	10	11.7	S08	0.02	AVGT06...
HPAV06M016S10R03	6	16	3	20	13	15.4	S10	0.03	AVGT06...
HPAV06M016S10R04	6	16	4	20	13	15.4	S10	0.03	AVGT06...

For connections between metric shank and TungMeister thread, please use VAD-M type connector

SPARE PARTS

Designation	Clamping screw	Lubricant	Wrench
HPAV06M...	CSPB-2H	M-1000	IP-6DB

Recommended clamping torque: 0.7 N-m

Designation	Wrench*
HPAV06M010S...	KEYV-S06
HPAV06M012S...	KEYV-S08
HPAV06M016S...	KEYV-S10

*sold separately

HPAV06/12-M

Square shoulder endmill, modular type (TungFlex), with screw clamp system

HPAV06-M: GAMP = +6.9°~ +7.6°, GAMF = -35.2°~ -32.4°
 HPAV12-M: GAMP = +6°~ +7.6°, GAMF = -37.1°~ -32.4°

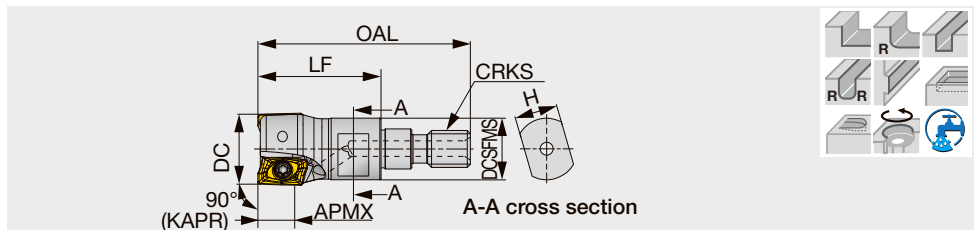

Designation	APMX	DC	CICT	OAL	LF	H	DCSFMS	CRKS	WT(kg)	Air hole	Insert
HPAV06M010M06R02	6	10	2	34.5	20	7	9.5	M6	0.01	Without	AVGT06...
HPAV06M012M06R02	6	12	2	34.5	20	7	10	M6	0.01	Without	AVGT06...
HPAV06M012M06R03	6	12	3	34.5	20	7	10	M6	0.01	Without	AVGT06...
HPAV06M016M08R03	6	16	3	42	25	10	13	M8	0.03	Without	AVGT06...
HPAV06M016M08R04	6	16	4	42	25	10	13	M8	0.03	Without	AVGT06...

SPARE PARTS

Designation	Clamping screw	Lubricant	Wrench
HPAV06M...	CSPB-2H	M-1000	IP-6DB

Recommended clamping torque: 1.3 N-m

INSERT

AVMT04-MM

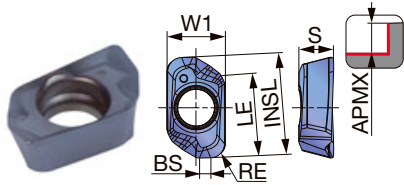

AVGT06-MJ

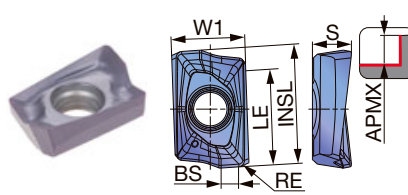

AVG06T-AJ

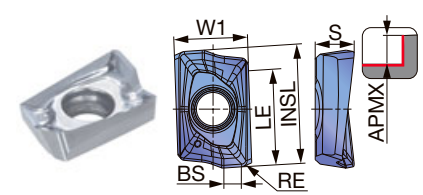

P Steel	☆	☆	★	★																
M Stainless		☆	☆	★	☆															
K Cast iron	★				☆															
N Non-ferrous									★											
S Superalloys	★	★		★																
H Hard materials	★																			

★ : First choice
☆ : Second choice

Designation	RE	APMX	Coated						Carbide		W1	INSL	S	BS	LE
			AH120	AH130	AH3135	AH3225	T1215	T3225	KS05F						
AVMT040204PPER-MM	0.4	4	●	●							3.5	6.05	2.1	1	4.4
AVMT040208PPER-MM	0.8	4	●	●							3.5	6.05	2.1	0.6	4.4
AVGT060300PBER-MJ	0.0	6			●	●					5	8	2.7	1.6	6.5
AVGT060302PBER-MJ	0.2	6	●	●	●	●					5	8	2.7	1.5	6.5
AVGT060304PBER-MJ	0.4	6	●	●	●	●					5	8	2.7	1.3	6.5
AVGT060308PBER-MJ	0.8	6	●	●	●	●					5	8	2.6	0.9	6.5
AVGT060300PBFR-AJ	0.0	6						●			5	8	2.7	1.6	6.5
AVGT060302PBFR-AJ	0.2	6						●			5	8	2.7	1.5	6.5
AVGT060304PBFR-AJ	0.4	6						●			5	8	2.7	1.3	6.5
AVGT060308PBFR-AJ	0.8	6						●			5	8	2.6	0.9	6.5

● : Line up

Approach angle

7°-25°

41°-45°

60°-70°

85°-88°

90°

Others

STANDARD CUTTING CONDITIONS

EPAV04

ISO	Workpiece materials	Hardness	Priority	Grades	Cutting speed Vc (m/min)	Feed per tooth fz (mm/t)
P	Low carbon steel S15C, SS400, etc. C15E, C15E4, E275A, etc.	- 200 HB	First choice	AH3225	100 - 300	0.05 - 0.12
	Carbon steel and alloy steel S55C, SCM440, etc. C55, 42CrMo4, etc.	- 300 HB	First choice	AH3225	100 - 250	0.05 - 0.12
	Prehardened steel NAK80, PX5, etc.	30 - 40 HRC	First choice	AH3225	100 - 200	0.05 - 0.1
M	Stainless steel SUS304, SUS316, etc. X5CrNi18-9, X5CrNiMo17-12-3, etc.	- 200 HB	First choice	AH3225	80 - 180	0.05 - 0.1
K	Grey cast iron FC250, FC300, etc. 250, 300, etc.	150 - 250 HB	First choice	AH120	100 - 300	0.05 - 0.12
	Ductile cast iron FCD400, FCD600, etc. GGG60, 600-3, etc.	150 - 250 HB	First choice	AH120	100 - 250	0.05 - 0.12
S	Titanium alloys Ti-6Al-4V, etc.	- 40 HRC	First choice	AH3225	20 - 60	0.04 - 0.07
	Superalloys Inconel 718, etc.	- 40 HRC	First choice	AH120	20 - 40	0.04 - 0.07
H	Hardened steel	SKD61, X40CrMoV5-1, etc.	First choice	AH120	50 - 150	0.04 - 0.07
		SKD11, X153CrMoV12, etc.	First choice	AH120	40 - 70	0.04 - 0.07

EPAV06, HPAV06-M, HPAV06-S, TPAV06

ISO	Workpiece materials	Hardness	Priority	Grades	Cutting speed Vc (m/min)	Feed per tooth fz (mm/t)	
P	Low carbon steel S15C, SS400, etc. C15E, C15E4, E275A, etc.	- 200 HB	First choice	AH3225	230 - 430	0.07 - 0.12	
	Carbon steel and alloy steel S55C, SCM440, etc. C55, 42CrMo4, etc.	- 300 HB	First choice	AH3225	150 - 350	0.07 - 0.12	
	Prehardened steel NAK80, PX5, etc.	30 - 40 HRC	First choice	AH3225	100 - 230	0.07 - 0.12	
M	Stainless steel SUS304, SUS316, etc. X5CrNi18-9, X5CrNiMo17-12-3, etc.	- 200 HB	First choice	AH3135	150 - 220	0.06 - 0.1	
K	Grey cast iron FC250, FC300, etc. 250, 300, etc.	150 - 250 HB	First choice	AH120	200 - 330	0.07 - 0.12	
	Ductile cast iron FCD400, FCD600, etc. GGG60, 600-3, etc.	150 - 250 HB	First choice	AH120	150 - 240	0.07 - 0.12	
N	Aluminium alloys Si < 13%	-	First choice	KS05F	650 - 1000	0.07 - 0.12	
	Aluminium alloys Si ≥ 13%	-	First choice	KS05F	100 - 230	0.04 - 0.12	
S	Titanium alloys Ti-6Al-4V, etc.	- 40 HRC	First choice	AH130	40 - 90	0.04 - 0.1	
	Superalloys Inconel 718, etc.	- 40 HRC	First choice	AH130	45 - 65	0.04 - 0.09	
H	Hardened steel	SKD61, X40CrMoV5-1, etc.	40 - 50 HRC	First choice	AH120	45 - 70	0.04 - 0.08
		SKD11, X153CrMoV12, etc.	50 - 60 HRC	First choice	AH120	40 - 65	0.04 - 0.06

MACHINING APPLICATIONS

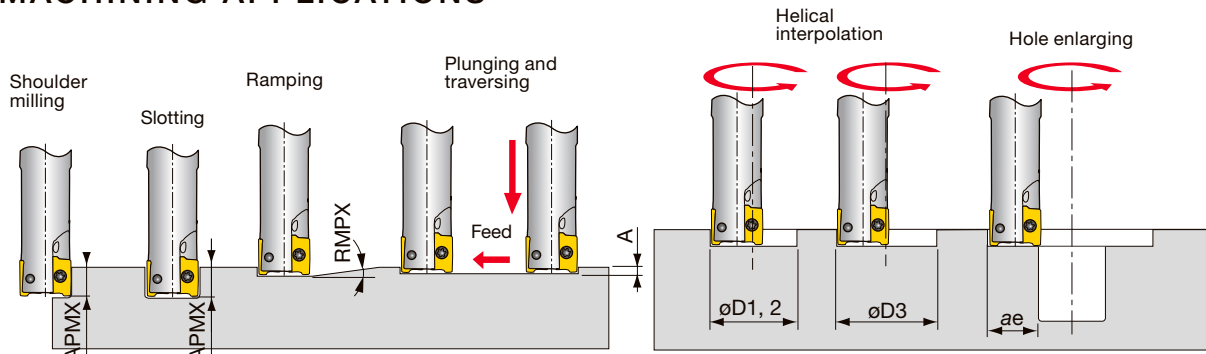

Designation	DC	Max. depth of cut		Max. plunging	Min. machining	Max. machining		Max. cutting width in enlarging
		APMX	RMPX			$\phi D2$	$\phi D3^*$	
EPAV04M006C06.0R01	6	4	0.4°	0.03	9.3	11.6	9.9	5.5
EPAV04M008C08.0R02	8	4	0.5°	0.04	12.7	15.6	13.6	7.5
EPAV04M008C08.0R02L	8	4	0.5°	0.04	12.7	15.6	13.6	7.5
EPAV04M010C10.0R02	10	4	4.1°	0.4	15.3	19.6	17.5	9.5
EPAV04M010C10.0R03	10	4	1.7°	0.2	16.1	19.6	17.5	9.5
EPAV04M010C10.0R02L	10	4	4.1°	0.4	16.1	19.6	17.5	9.5
EPAV04M012C12.0R03	12	4	2.7°	0.4	19.3	23.6	21.5	11.5
EPAV04M012C12.0R04	12	4	1.3°	0.2	20.1	23.6	21.5	11.5
EPAV04M012C12.0R03L	12	4	2.7°	0.4	19.3	23.6	21.5	11.5
EPAV04M016C16.0R04	16	4	2°	0.4	27.2	31.6	29.5	15.5
EPAV04M016C16.0R05	16	4	2°	0.4	27.2	31.6	29.5	15.5
EPAV04M016C16.0R04L	16	4	2°	0.4	27.2	31.6	29.5	15.5
EPAV06M008...	8	6	-	-	-	-	-	-
EPAV/HPAV06M010...	10	6	3°	0.3	15	19	18	9.5
EPAV/HPAV06M012...	12	6	3°	0.3	18	23	22	11.5
EPAV/HPAV06M014...	14	6	2.3°	0.3	22	27	26	13.5
EPAV/HPAV06M016...	16	6	2°	0.3	28	31	30	15.5

*Flat bottom hole

When clamping the insert, please confirm that there is no gap between the cutter body and the insert as shown in the picture.

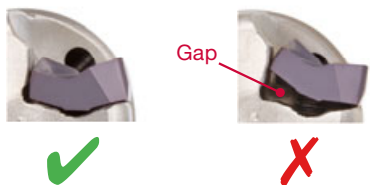

Grade
Insert
Ext. Toolholder
Int. Toolholder
Threading
Grooving
Shaper
Endmill
Drilling Tool
Technical Reference

High precision square shoulder endmill, shank type, with screw clamp system

EPA04: GAMP = +12.1°~ +12.2°, GAMF = -14.2°~ -18.3°, EPA06: GAMP = +8.5°~ +11.5°, GAMF = -5.5°~ -12.5°, EPA10: GAMP = +9.5°~ +11°, GAMF = -4.5°~ -0.5°, EPA15: GAMP = +12°~ +13.5°, GAMF = -6°~ -3.5°

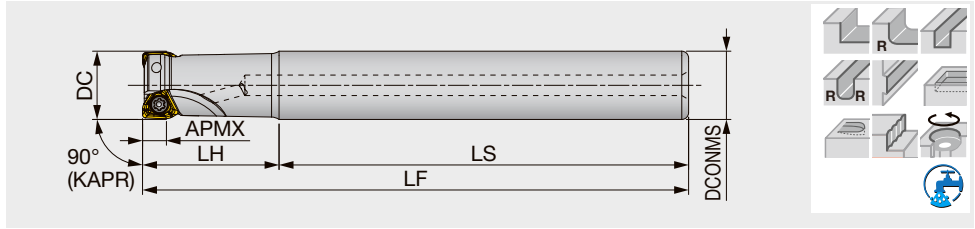

Designation	APMX	DC	CICT	DCONMS	LS	LH	LF	WT(kg)	Air hole	Insert
EPA04R008M08.0-01	3.5	8	1	8	48	12	60	0.02	with	TOMT04...
EPA04R010M10.0-02	3.5	10	2	10	60	20	80	0.04	with	TOMT04...
EPA04R010M10.0-02L	3.5	10	2	10	65	35	100	0.05	with	TOMT04...
EPA04R012M12.0-02	3.5	12	2	12	60	20	80	0.06	with	TOMT04...
EPA04R012M12.0-03	3.5	12	3	12	60	20	80	0.06	with	TOMT04...
EPA04R012M12.0-02L	3.5	12	2	12	85	35	120	0.09	with	TOMT04...
EPA04R016M16.0-03	3.5	16	3	16	70	20	90	0.12	with	TOMT04...
EPA04R016M16.0-04	3.5	16	4	16	70	20	90	0.12	with	TOMT04...
EPA04R016M16.0-03L	3.5	16	3	16	105	35	140	0.19	with	TOMT04...

SPARE PARTS



Designation	Clamping screw	Grip
EPA04R008M08.0-01	CSPB-1.8L3.3	IP-6DB
EPA04R010 - 025...	CSPB-1.8L3.6	IP-6DB

Recommended clamping torque: CSPB-1.8L3.6 = 0.5 N·m, CSPB-1.8L3.3 = 5 N·m

INSERTS

TOMT-MM

Approach angle

7°-25°

41°-45°

60°-70°

85°-88°

90°

Others

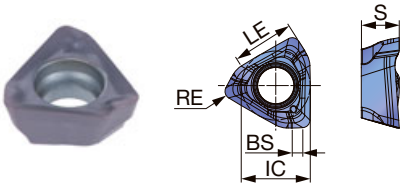

	P	M	K	N	S	H
Steel	☆	★				
Stainless		★				
Cast iron	★					
Non-ferrous						
Superalloys	★	★	★			
Hard materials			★			

★ : First choice
☆ : Second choice

Designation	RE	APMX	Coated			LE	IC	S	BS
			AH120	AH3225	AH8015				
TOMT040204PXER-MM	0.4	3.5	●	●	●	3.6	4	2.2	0.6
TOMT040208PXER-MM	0.8	3.5	●	●	●	3.6	4	2.2	0.2

● : Line up

STANDARD CUTTING CONDITIONS

EPA04



















ISO	Workpiece materials	Hardness	Grades	Cutting speed Vc (m/min)	Feed per tooth fz (mm/t)
P	Low carbon steel SS400, S15C, etc. E275A, C15E4, etc.	- 200 HB	AH3225	100 - 250	0.05 - 0.12
	Carbon steel and alloy steel S55C, SCM440, etc. C55, 42CrMo4, etc.	- 300 HB	AH3225	100 - 230	0.05 - 0.12
	Prehardened steel NAK80, PX5, etc.	30 - 40 HRC	AH3225	100 - 180	0.05 - 0.1
M	Stainless steel SUS304, etc. X5CrNi18-9, etc.	- 200 HB	AH3225	90 - 200	0.05 - 0.1
K	Grey cast iron FC250, etc. 250, etc., GGG25, etc.	150 - 250 HB	AH120	100 - 300	0.05 - 0.12
	Ductile cast iron FCD450, etc. 450-10S, etc., GGG45, etc.	150 - 250 HB	AH120	100 - 200	0.05 - 0.12
S	Titanium alloys Ti-6Al-4V, etc.	- 40 HRC	AH3225	20 - 60	0.04 - 0.07
	Heat-resistant alloys Inconel 718, etc.	- 40 HRC	AH8015	20 - 40	0.04 - 0.07
H	Hardened steel	SKD61, etc. X40CrMoV5-1, etc.	AH8015	50 - 150	0.04 - 0.07
		SKD11, etc. X153CrMoV12, etc.	AH8015	40 - 70	0.04 - 0.07

- Remove excessive chip accumulation with an air blast.
- For an operation when the depth of cut varies (ex.casting skin) or machining of workpiece materials with interrupted surface, the feed per tooth (fz) should be set to the lower recommended value shown in the above table.

- Cutting conditions may be limited depending on machine power, workpiece rigidity, and spindle output. When the cutting width, depth, or overhang length is large, set Vc and fz to the lower recommended values and check the machine power and vibration.

Grade
1
Insert
2
Ext. Toolholder
3
Int. Toolholder
4
Threading
5
Grooving
6
Shaper
7
Endmill
8
Drilling Tool
9
Technical Reference
10

Quick Guide **SOLIDMEISTER**

Edge shape	Name of the series	Designation	Appearance	Application			Tool diameter	No. of cutting edges		
				Finishing	Medium cutting	Roughing				
 Square	VARIABLEMEISTER	TEC**H4S/M**CF-E			✓	✓	ø6 - ø12	4		
		TEC**E4L**CF			✓	✓	ø1 - ø12	4		
		TECK**H4M**CF-R			✓	✓	ø4 - ø12	4		
		TEC**H4M**CF-R			✓	✓	ø6 - ø12	4		
		TECA**H3**CF-R			✓	✓	ø1 - ø12	3		
		TECA**H4**CF-R			✓	✓	ø6 - ø12	4		
		TECA**H3**CF-R**C			✓		ø6 - ø12	3		
	FINISHMEISTER	TEFS**E44**CF			✓	✓	ø6 - ø12	4		
		TEFS**B44			✓	✓	ø4 - ø12	4		
	SOLIDMEISTER	TECC**A/B2			✓	✓	✓	ø2 - ø12	2	
		TECS/TECCS**E3			✓	✓	✓	ø2 - ø12	3	
		TECC**E3			✓	✓	✓	ø4 - ø12	3	
		TEC**B3				✓	✓	ø6 - ø12	3	
		TECC**A/B4			✓	✓	✓	ø2 - ø12	4	
		TEC**B4			✓	✓		ø2 - ø12	4	
		TEC**B4**R			✓	✓		ø6 - ø12	4	
		TEC**A2				✓		ø0.4 - ø3	2	
		TEC**A4				✓		ø4 - ø12	4	

★ : First choice ☆ : Second choice

	ap	Corner geometry	Helix angle	Pitch	Workpiece material					Remarks	Page
					P	M	N	S	H		
	1D, 2D	Chamfered/R	Variable	Variable	★	★	☆	☆	☆		8-14
	2D	Chamfered/ Sharp edge	38	Variable	★	★	☆	☆	☆		8-15
	2D	R	Variable	Variable	★	★	☆	★	☆		8-15
	2D	R	Variable	Variable	★	★	☆	★	★		8-15
	1.5D, 2D	R	Variable	Variable	☆	☆	★	☆	☆		8-16
	1.5D, 2D	R	Variable	Variable	☆	☆	★	☆	☆		8-17
	2D	R	Variable	Variable	☆	☆	★	☆	☆		8-17
	2D	Chamfered	38	Variable	★	☆	☆	☆	☆	Rough/Finish combination geometry	8-19
	2D	Chamfered	45	Regular	★	★	☆	★	☆	Rough/Finish combination geometry	8-19
	2D, 3D	Chamfered	30/45	Regular	★	★	☆	☆	☆		8-21
	1D	Chamfered	38	Regular	★	★	☆	☆	☆		8-21
	2D, 3D	Chamfered	38	Regular	★	★	☆	☆	☆		8-21
	2D	Sharp edge	45	Regular	★	★	☆	☆	☆		8-22
	2D	Chamfered	30/45	Regular	★	★	☆	☆	☆		8-22
	2D, 3D	Sharp edge	45	Regular	★	★	☆	☆	☆		8-22
	2D	Sharp edge	45	Regular	★	★	☆	☆	☆		8-23
	1.5D	Sharp edge	30	Regular	★	☆	☆	☆	★		8-24
	2D	Sharp edge	30	Regular	★	☆	☆	☆	★		8-25

Quick Guide **SOLIDMEISTER**

Edge shape	Name of the series	Designation	Appearance	Application			Tool diameter	No. of cutting edges	
				Finishing	Medium cutting	Roughing			
 Square	SOLIDMEISTER	TECA**B2		✓			ø4 - ø12	2	
		TECA**B3			✓	✓	ø4 - ø12	3	
		TECA**F2		✓			ø4 - ø12	2	
	ECOMEISTER	TEC**A2**E			✓		ø1 - ø12	2	
		TEC**A/E3**E			✓		ø2 - ø12	3	
		TEC**B3**W			✓		ø2 - ø12	3	
		TEC**A4**E			✓		ø2 - ø12	4	
 Ball	SOLIDMEISTER	TEB**A2-**C**M		✓	✓		ø0.4 - ø3	2	
		TEB**A2-**C**H		✓	✓		ø1 - ø12	2	
		TEB**A2-**C**M...		✓	✓		ø3 - ø12	2	
		TEB**A2**/**/**C**M...		✓	✓		ø1 - ø10	2	
		TEB**A2-**C**-...		✓	✓		ø3 - ø12	2	
		TEB**A3		✓	✓		ø3 - ø12	3	
	TEB**A4		✓	✓		ø3 - ø12	4		
ECOMEISTER	TEB**A2**E		✓	✓		ø2 - ø12	2		

★ : First choice ☆ : Second choice

	ap	Corner geometry	Helix angle	Pitch	Workpiece material					Remarks	Page
					P	M	N	S	H		
	2D, 3D	Sharp edge	45	Regular	☆	☆	★	☆	☆		8-21
	2D	R	45	Regular	☆	☆	★	☆	☆		8-21
	2D	Sharp edge	55	Regular	☆	☆	★	☆	☆		8-26
	1D, 1.5D, 2D, 3D, 4D	Sharp edge	30	Regular	★	★	☆	☆	☆		8-26
	1D, 1.5D, 2D, 3D, 4D	Sharp edge	30/38	Regular	★	★	☆	☆	☆		8-27
	1D	Sharp edge	45	Regular	★	★	☆	☆	☆		8-28
	2D, 3D, 4D, 5D, 6D, 8D, 10D	Sharp edge	30	Regular	★	★	☆	☆	☆		8-28
	1.5D	R0.2 - R1.5	30	Regular	★	★	☆	★	★		8-28
	1D	R0.5 - R10	30	Regular	★	★	☆	★	★		8-24
	2D	R1.5 - R8	30	Regular	★	★	☆	★	★		8-30
	2D	R0.5 - R5	30	Regular	★	★	☆	★	★	Tapered ball nose	8-20
	1D, 1.5D	R1.5 - R10	30	Regular	★	★	☆	★	★		8-31
	1D, 1.5D	R1.5 - R6	30	Regular	★	★	☆	★	★		8-32
	1D, 1.5D	R1.5 - R10	30	Regular	★	★	☆	★	★		8-33
	1D, 1.5D, 2D, 3D	R1 - R10	30	Regular	★	★	☆	★	★		8-33

VARIABLE MEISTER

TEC**H4S**CF-E

4 flute chatter dampening endmill, variable helix and variable pitch, short type

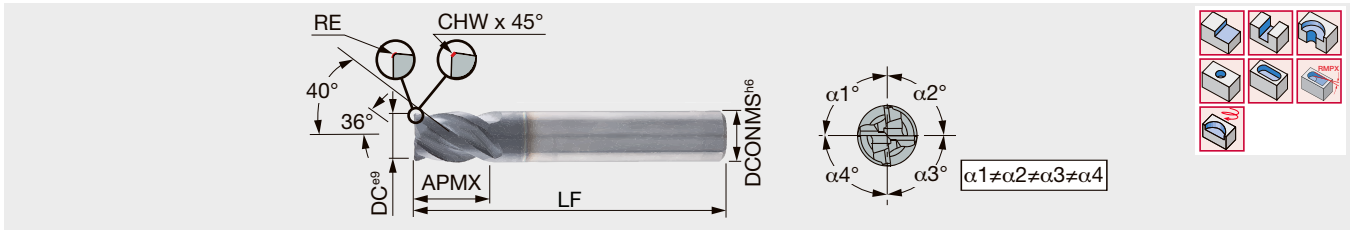

Designation	AH725	DC	DCONMS	NOF	CHW	RE	APMX	LF	Shank
TEC060H4S-06C06CF-E50	●	6	6	4	0.25	-	6	50	Cylindrical
TEC060H4S-06C06CF-R02E50	●	6	6	4	-	0.2	6	50	Cylindrical
TEC060H4S-06W06CF-E50	●	6	6	4	0.25	-	6	50	Weldon
TEC080H4S-08C08CF-E63	●	8	8	4	0.3	-	8	63	Cylindrical
TEC080H4S-08C08CF-R04E63	●	8	8	4	-	0.4	8	63	Cylindrical
TEC080H4S-08W08CF-E63	●	8	8	4	0.3	-	8	63	Weldon
TEC100H4S-10C10CF-E66	●	10	10	4	0.4	-	10	66	Cylindrical
TEC100H4S-10C10CFR.5E66	●	10	10	4	-	0.5	10	66	Cylindrical
TEC100H4S-10W10CF-E66	●	10	10	4	0.4	-	10	66	Weldon
TEC120H4S-12C12CF-E73	●	12	12	4	0.5	-	12	73	Cylindrical
TEC120H4S-12C12CF-R06E73	●	12	12	4	-	0.6	12	73	Cylindrical
TEC120H4S-12W12CF-E73	●	12	12	4	0.5	-	12	73	Weldon

● : Line up

TEC**H4M**CF-E

4 flute chatter dampening endmill, variable helix and variable pitch

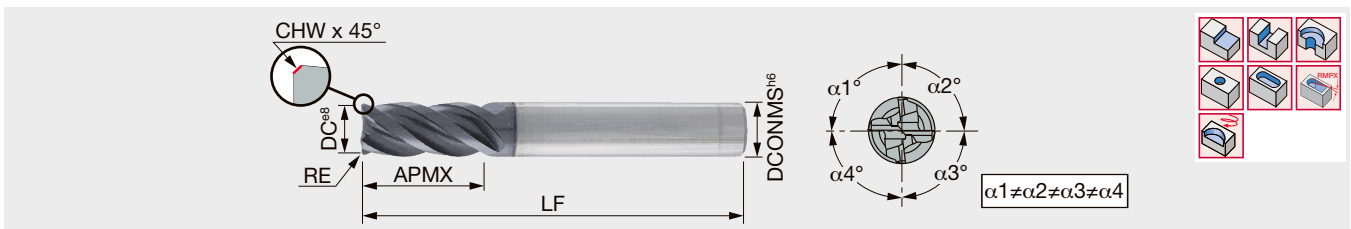

Designation	AH725	DC	DCONMS	NOF	CHW	APMX	LF	Shank
TEC060H4M-12C06CF-E57	●	6	6	4	0.25	12	57	Cylindrical
TEC060H4M-12W06CF-E57	●	6	6	4	0.25	12	57	Weldon
TEC080H4M-16C08CF-E63	●	8	8	4	0.3	16	63	Cylindrical
TEC080H4M-16W08CF-E63	●	8	8	4	0.3	16	63	Weldon
TEC100H4M-20C10CF-E72	●	10	10	4	0.4	20	72	Cylindrical
TEC100H4M-20W10CF-E72	●	10	10	4	0.4	20	72	Weldon
TEC120H4M-24C12CF-E83	●	12	12	4	0.5	24	83	Cylindrical
TEC120H4M-24W12CF-E83	●	12	12	4	0.5	24	83	Weldon

● : Line up

Reference pages: Standard cutting conditions → [8-18](#)

TEC**E4L**CF

4 flute chatter dampening endmill, 38° helix angle, variable pitch, short type

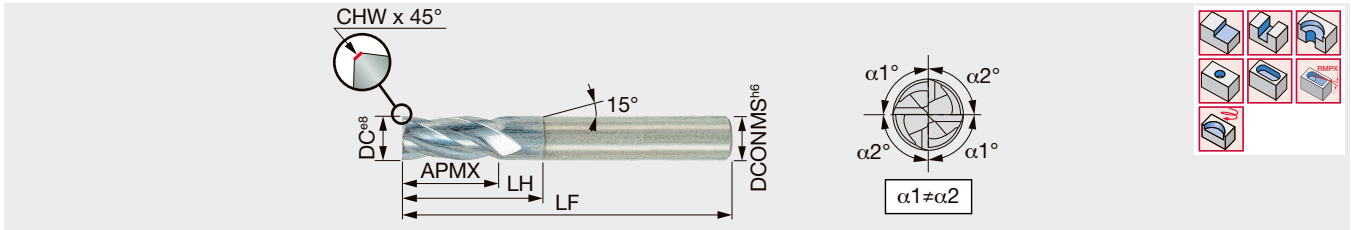

Designation	AH725	DC	DCONMS	NOF	CHW	APMX	LH	LF	Shank
TEC010E4L-2/04C04CF50	●	1	4	4	0.04	2.2	4	50	Cylindrical
TEC020E4L-4/06C04CF50	●	2	4	4	0.08	4.3	6.1	50	Cylindrical
TEC030E4L-8/11C06CF-57	●	3	6	4	0.1	8	11	57	Cylindrical
TEC040E4L-10/14C06CF-57	●	4	6	4	0.15	10	14	57	Cylindrical
TEC050E4L-12/17C06CF-57	●	5	6	4	0.18	12	17	57	Cylindrical
TEC060E4L-14/20C06CF-57	●	6	6	4	0.25	14	20	57	Cylindrical
TEC080E4L-18/26C08CFS63	●	8	8	4	-	18	26	63	Cylindrical
TEC080E4L-18/26C08CF-63	●	8	8	4	0.3	18	26	63	Cylindrical
TEC080E4L-18/26W08CF63	●	8	8	4	0.3	18	26	63	Weldon
TEC100E4L-22/32C10CFS72	●	10	10	4	-	22	32	72	Cylindrical
TEC100E4L-22/32C10CF-72	●	10	10	4	0.4	22	32	72	Cylindrical
TEC100E4L-22/32W10CF72	●	10	10	4	0.4	22	32	72	Weldon
TEC120E4L-26/38C12CFS83	●	12	12	4	-	26	38	83	Cylindrical
TEC120E4L-26/38C12CF-83	●	12	12	4	0.5	26	38	83	Cylindrical
TEC120E4L-26/38W12CF83	●	12	12	4	0.5	26	38	83	Weldon

● : Line up

TECK**H4M**CF-R

4 flute chatter dampening endmill, variable helix and variable pitch, for titanium machining

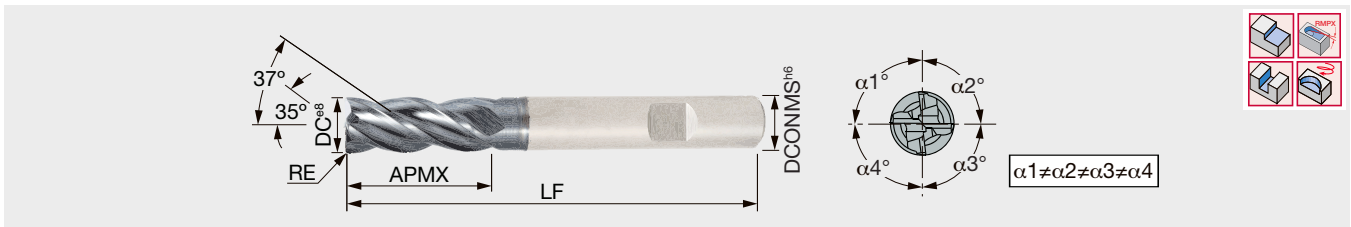

Designation	AH725	DC	DCONMS	NOF	RE	APMX	RMPX	LF	Shank
TECK040H4M-08C06CF-R02	●	4	6	4	0.2	8	5°	57	Cylindrical
TECK050H4M-10C06CF-R02	●	5	6	4	0.2	10	5°	57	Cylindrical
TECK060H4M-12C06CF-R02	●	6	6	4	0.2	12	5°	57	Cylindrical
TECK060H4M-12W06CF-R02	●	6	6	4	0.2	12	5°	57	Weldon
TECK080H4M-16C08CF-R04	●	8	8	4	0.4	16	5°	63	Cylindrical
TECK080H4M-16W08CF-R04	●	8	8	4	0.4	16	5°	63	Weldon
TECK100H4M-20C10CF-R05	●	10	10	4	0.5	20	5°	72	Cylindrical
TECK100H4M-20W10CF-R05	●	10	10	4	0.5	20	5°	72	Weldon
TECK120H4M-24C12CF-R06	●	12	12	4	0.6	24	5°	83	Cylindrical
TECK120H4M-24W12CF-R06	●	12	12	4	0.6	24	5°	83	Weldon

● : Line up

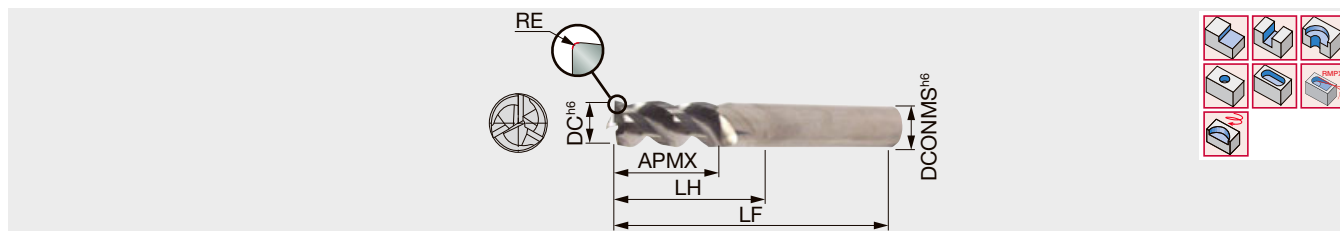

Designation	KS15F	DC	DCONMS	NOF	RE	APMX	LH	LF	Shank
TECA010H3-04C06CF-R.05	●	1	6	3	0.05	4	6	57	Cylindrical
TECA015H3-04/06C06CF-R01	●	1.5	6	3	0.1	4	6	57	Cylindrical
TECA020H3-05/08C06CF-R01	●	2	6	3	0.1	5	8	57	Cylindrical
TECA025H3-05/08C06CF-R01	●	2.5	6	3	0.1	5	8	57	Cylindrical
TECA030H3-07/12C06CF-R01	●	3	6	3	0.1	7	12	57	Cylindrical
TECA040H3-10/16C06CF-R02	●	4	6	3	0.2	10	16	57	Cylindrical
TECA050H3-12/20C06CF-R02	●	5	6	3	0.2	12	20	57	Cylindrical
TECA060H3-09/18C06CF-R02	●	6	6	3	0.2	9	18	57	Cylindrical
TECA060H3-09/18C06CF-R04	●	6	6	3	0.4	9	18	57	Cylindrical
TECA060H3-09/18C06CF-R08	●	6	6	3	0.8	9	18	57	Cylindrical
TECA060H3-09/30C06CF-R02	●	6	6	3	0.2	9	30	65	Cylindrical
TECA060H3-09/30C06CF-R04	●	6	6	3	0.4	9	30	65	Cylindrical
TECA060H3-09/30C06CF-R08	●	6	6	3	0.8	9	30	65	Cylindrical
TECA060H3-14/24C06CF-R02	●	6	6	3	0.2	14	24	60	Cylindrical
TECA080H3-12/24C08CF-R02	●	8	8	3	0.2	12	24	63	Cylindrical
TECA080H3-12/24C08CF-R04	●	8	8	3	0.4	12	24	63	Cylindrical
TECA080H3-12/24C08CF-R08	●	8	8	3	0.8	12	24	63	Cylindrical
TECA080H3-12/24C08CF-R30	●	8	8	3	3	12	24	63	Cylindrical
TECA080H3-12/40C08CF-R02	●	8	8	3	0.2	12	40	79	Cylindrical
TECA080H3-12/40C08CF-R04	●	8	8	3	0.4	12	40	79	Cylindrical
TECA080H3-12/40C08CF-R08	●	8	8	3	0.8	12	40	79	Cylindrical
TECA080H3-18/32C08CF-R02	●	8	8	3	0.2	18	32	68	Cylindrical
TECA100H3-15/30C10CF-R02	●	10	10	3	0.2	15	30	72	Cylindrical
TECA100H3-15/30C10CF-R04	●	10	10	3	0.4	15	30	72	Cylindrical
TECA100H3-15/30C10CF-R08	●	10	10	3	0.8	15	30	72	Cylindrical
TECA100H3-15/30C10CF-R16	●	10	10	3	1.6	15	30	72	Cylindrical
TECA100H3-15/30C10CF-R30	●	10	10	3	3	15	30	72	Cylindrical
TECA100H3-15/50C10CF-R02	●	10	10	3	0.2	15	50	92	Cylindrical
TECA100H3-15/50C10CF-R04	●	10	10	3	0.4	15	50	92	Cylindrical
TECA100H3-15/50C10CF-R08	●	10	10	3	0.8	15	50	92	Cylindrical
TECA100H3-15/50C10CF-R16	●	10	10	3	1.6	15	50	92	Cylindrical
TECA100H3-15/50C10CF-R20	●	10	10	3	2	15	50	92	Cylindrical
TECA100H3-15/50C10CF-R30	●	10	10	3	3	15	50	92	Cylindrical
TECA100H3-22/40C10CF-R02	●	10	10	3	0.2	22	40	80	Cylindrical
TECA100H3-22/40C10CF-R30	●	10	10	3	3	22	40	80	Cylindrical
TECA120H3-18/36C12CF-R02	●	12	12	3	0.2	18	36	83	Cylindrical
TECA120H3-18/36C12CF-R04	●	12	12	3	0.4	18	36	83	Cylindrical
TECA120H3-18/36C12CF-R08	●	12	12	3	0.8	18	36	83	Cylindrical
TECA120H3-18/36C12CF-R16	●	12	12	3	1.6	18	36	83	Cylindrical
TECA120H3-18/36C12CF-R20	●	12	12	3	2	18	36	83	Cylindrical
TECA120H3-18/36C12CF-R25	●	12	12	3	2.5	18	36	83	Cylindrical
TECA120H3-18/60C12CF-R02	●	12	12	3	0.2	18	60	100	Cylindrical
TECA120H3-18/60C12CF-R04	●	12	12	3	0.4	18	60	100	Cylindrical
TECA120H3-18/60C12CF-R08	●	12	12	3	0.8	18	60	100	Cylindrical
TECA120H3-18/60C12CF-R16	●	12	12	3	1.6	18	60	100	Cylindrical
TECA120H3-18/60C12CF-R20	●	12	12	3	2	18	60	100	Cylindrical
TECA120H3-18/60C12CF-R25	●	12	12	3	2.5	18	60	100	Cylindrical
TECA120H3-18/60C12CF-R30	●	12	12	3	3	18	60	100	Cylindrical

● : Line up

VARIABLE MEISTER

TECA**H4**CF-R

4 flute endmill, variable helix and variable pitch, relieved neck type, for aluminium machining (1.5xD, 2xD)

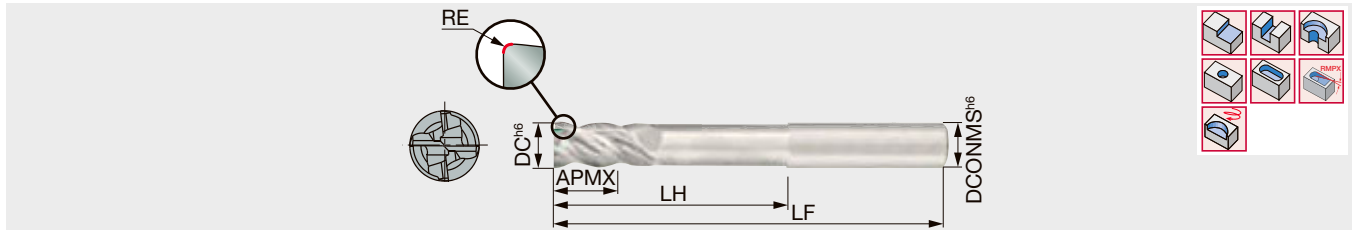

Designation	KS15F	DC	DCONMS	NOF	RE	APMX	LH	LF	Shank
TECA060H4-09/30C06CF-R02	●	6	6	4	0.2	9	30	65	Cylindrical
TECA060H4-12/18C06CF-R02	●	6	6	4	0.2	12	18	57	Cylindrical
TECA080H4-12/40C08CF-R02	●	8	8	4	0.2	12	40	79	Cylindrical
TECA080H4-16/24C08CF-R02	●	8	8	4	0.2	16	24	63	Cylindrical
TECA100H4-15/50C10CF-R02	●	10	10	4	0.2	15	50	92	Cylindrical
TECA100H4-20/30C10CF-R02	●	10	10	4	0.2	20	30	72	Cylindrical
TECA120H4-18/60C12CF-R02	●	12	12	4	0.2	18	60	100	Cylindrical
TECA120H4-24/36C12CF-R02	●	12	12	4	0.2	24	36	83	Cylindrical

● : Line up

TECA**H3**CF-R**C

3 flute endmill, variable helix and variable pitch, center cutting edge, for aluminium machining

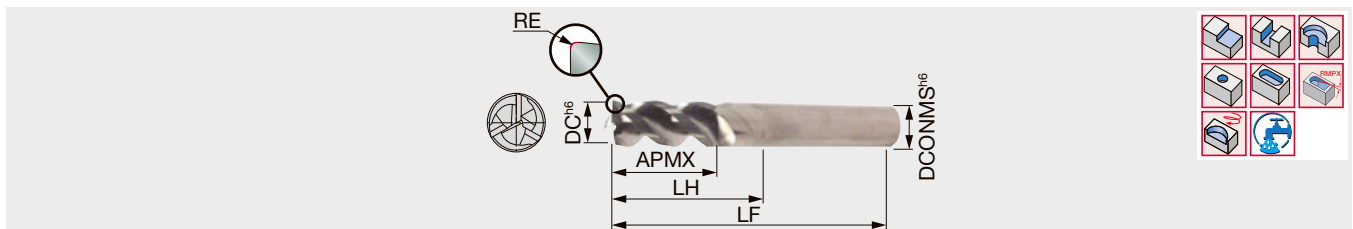

Designation	KS15F	DC	DCONMS	NOF	RE	APMX	LH	LF	Coolant hole	Shank
TECA060H3-12/18C06CF-R02C	●	6	6	3	0.2	12	18	57	With	Cylindrical
TECA060H3-12/30C06CF-R02C	●	6	6	3	0.2	12	30	65	With	Cylindrical
TECA080H3-16/24C08CF-R02C	●	8	8	3	0.2	16	24	63	With	Cylindrical
TECA080H3-16/40C08CF-R02C	●	8	8	3	0.2	16	40	79	With	Cylindrical
TECA100H3-20/30C10CF-R02C	●	10	10	3	0.2	20	30	72	With	Cylindrical
TECA100H3-20/50C10CF-R02C	●	10	10	3	0.2	20	50	100	With	Cylindrical
TECA120H3-24/36C12CF-R02C	●	12	12	3	0.2	24	36	83	With	Cylindrical
TECA120H3-24/60C12CF-R02C	●	12	12	3	0.2	24	60	100	With	Cylindrical

● : Line up

STANDARD CUTTING CONDITIONS

Slotting / Roughing ($a_e = 0.4 \times D$ or over)

ISO	Workpiece material	Hardness	Vc (m/min)	fz (mm/t)		ap (Slotting)
				$\phi 6 - \phi 8$	$\phi 10 - \phi 12$	
P	Carbon steel	- 300 HB	140 - 180	0.03 - 0.045	0.035 - 0.055	2xD
	Alloy steel	- 300 HB	70 - 150	0.025 - 0.04	0.035 - 0.055	2xD
M	Stainless steel	- 200 HB	60 - 100	0.025 - 0.045	0.035 - 0.05	1xD
K	Cast iron	150 - 200 HB	80 - 180	0.025 - 0.05	0.035 - 0.065	2xD
N	Aluminium alloy	-	300 - 750	0.025 - 0.05	0.035 - 0.065	2xD
S	Titanium alloy	- 40 HRC	20 - 50	0.025 - 0.04	0.03 - 0.05	1xD
H	Hardened steel	- 60 HRC	20 - 30	0.01 - 0.02	0.02 - 0.04	0.5xD

Semi-finishing / Shouldering ($a_e = 0.1 \sim 0.4 \times D$)

ISO	Workpiece material	Hardness	Vc (m/min)	fz (mm/t)		ap
				$\phi 6 - \phi 8$	$\phi 10 - \phi 12$	
P	Carbon steel	- 300 HB	150 - 220	0.035 - 0.075	0.075 - 0.09	2xD
	Alloy steel	- 300 HB	70 - 160	0.025 - 0.065	0.05 - 0.09	2xD
M	Stainless steel	- 200 HB	80 - 130	0.03 - 0.05	0.04 - 0.06	2xD
K	Cast iron	150 - 250 HB	130 - 220	0.035 - 0.065	0.05 - 0.075	2xD
N	Aluminium alloy	-	350 - 850	0.05 - 0.075	0.075 - 0.1	2xD
S	Titanium alloy	- 40 HRC	40 - 60	0.035 - 0.05	0.04 - 0.065	2xD
H	Hardened steel	- 60 HRC	30 - 70	0.015 - 0.045	0.03 - 0.05	2xD

Finishing (feed rate depending on required accuracy) / High feed machining at low depth of cut ($a_e = 0.05 \sim 0.1 \times D$)

ISO	Workpiece material	Hardness	Vc (m/min)	fz (mm/t)		ap
				$\phi 6 - \phi 8$	$\phi 10 - \phi 12$	
P	Carbon steel	- 300 HB	170 - 280	0.06 - 0.09	0.085 - 0.1	apmax
	Alloy steel	- 300 HB	110 - 220	0.06 - 0.09	0.085 - 0.1	apmax
M	Stainless steel	- 200 HB	100 - 160	0.035 - 0.055	0.05 - 0.065	apmax
K	Cast iron	150 - 250 HB	180 - 280	0.04 - 0.075	0.075 - 0.08	apmax
N	Aluminium alloy	-	350 - 900	0.055 - 0.09	0.085 - 0.125	apmax
S	Titanium alloy	- 40 HRC	50 - 70	0.04 - 0.065	0.05 - 0.075	apmax
H	Hardened steel	- 60 HRC	40 - 80	0.025 - 0.05	0.04 - 0.065	apmax

- When the depth of cut (a_e) is closer to the upper limit, please start with a lower limit value of cutting speed (Vc).
- Please set the cutting speed and the feed rate lower for the items with long slot according to how chattering occurs.
- While air blow is recommended, water-soluble coolant will be good for stainless steel, titanium alloy, and heat-resistant alloy.
- When chattering occurs with low rigid machines or settings, reduce cutting speed and feed at an equal rate.
- When chattering occurs with long tool overhang, reduce cutting speed and feed by 20 to 40%.

4 flute endmill, 38° helix angle, variable pitch, roughing and finishing combination type

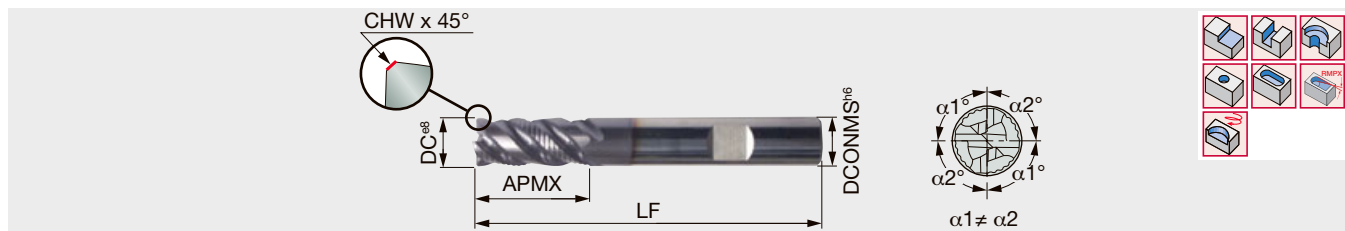

Designation	AH725	DC	DCONMS	NOF	CHW	APMX	LF	Shank
TEFS060E44-14C06CF57	●	6	6	4	0.25	14	57	Cylindrical
TEFS060E44-14W06CF-57	●	6	6	4	0.25	14	57	Weldon
TEFS080E44-18C08CF63	●	8	8	4	0.3	18	63	Cylindrical
TEFS080E44-18W08CF-63	●	8	8	4	0.3	18	63	Weldon
TEFS100E44-22C10CF72	●	10	10	4	0.4	22	72	Cylindrical
TEFS100E44-22W10CF-72	●	10	10	4	0.4	22	72	Weldon
TEFS120E44-26C12CF83	●	12	12	4	0.5	26	83	Cylindrical
TEFS120E44-26W12CF-83	●	12	12	4	0.5	26	83	Weldon

● : Line up

TEFS**B44

4 flute endmill, 45° helix angle, roughing and finishing combination type

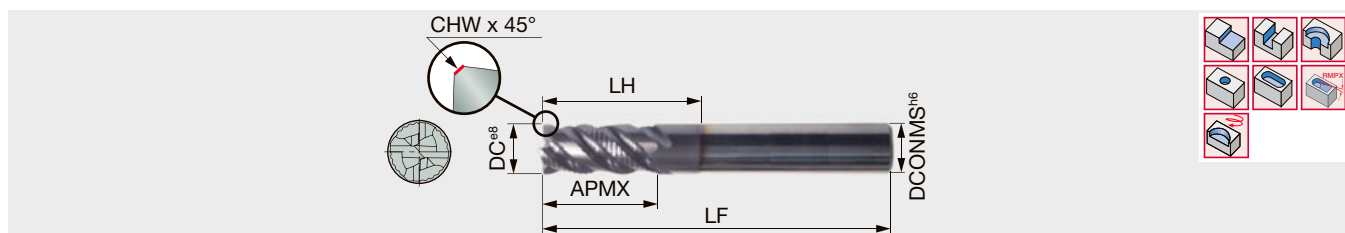

Designation	AH725	DC	DCONMS	NOF	CHW	APMX	LH	LF	Shank
TEFS040B44-10C06-57	●	4	6	4	0.12	10	-	57	Cylindrical
TEFS050B44-12C06-57	●	5	6	4	0.18	12	-	57	Cylindrical
TEFS060B44-14/20C06-57	●	6	6	4	0.25	14	20	57	Cylindrical
TEFS060B4414/20W06-57	●	6	6	4	0.25	14	20	57	Weldon
TEFS060B44-14C06-57	●	6	6	4	0.25	14	-	57	Cylindrical
TEFS060B44-14W06-57	●	6	6	4	0.25	14	-	57	Weldon
TEFS080B44-18/26C08-63	●	8	8	4	0.3	18	26	63	Cylindrical
TEFS080B44-18/26W08-63	●	8	8	4	0.3	18	26	63	Weldon
TEFS080B44-18C08-63	●	8	8	4	0.3	18	-	63	Cylindrical
TEFS080B44-18W08-63	●	8	8	4	0.3	18	-	63	Weldon
TEFS100B44-22/32C10-72	●	10	10	4	0.3	22	32	72	Cylindrical
TEFS100B44-22/32W10-72	●	10	10	4	0.3	22	32	72	Weldon
TEFS100B44-22C10-72	●	10	10	4	0.3	22	-	72	Cylindrical
TEFS100B44-22W10-72	●	10	10	4	0.3	22	-	72	Weldon
TEFS120B44-26/38C12-83	●	12	12	4	0.4	26	38	83	Cylindrical
TEFS120B44-26/38W12-83	●	12	12	4	0.4	26	38	83	Weldon
TEFS120B44-26C12-83	●	12	12	4	0.4	26	-	83	Cylindrical
TEFS120B44-26W12-83	●	12	12	4	0.4	26	-	83	Weldon

● : Line up

FINISHMEISTER SHREDMEISTER

STANDARD CUTTING CONDITIONS

Slotting / Roughing ($ae = 0.4 \times D$ or over)

ISO	Workpiece material	Hardness	Vc (m/min)	fz (mm/t)		ap (Slotting)
				$\phi 6 - \phi 8$	$\phi 10 - \phi 12$	
P	Carbon steel	- 300 HB	140 - 180	0.035 - 0.055	0.045 - 0.07	2xD
	Alloy steel	- 300 HB	70 - 150	0.03 - 0.045	0.045 - 0.07	2xD
M	Stainless steel	- 200 HB	60 - 100	0.03 - 0.055	0.045 - 0.06	1xD
K	Cast iron	150 - 200 HB	80 - 180	0.03 - 0.06	0.045 - 0.08	2xD
N	Aluminium alloy	-	300 - 750	0.03 - 0.06	0.045 - 0.08	2xD
S	Titanium alloy	- 40 HRC	20 - 50	0.03 - 0.045	0.04 - 0.06	1xD
H	Hardened steel	- 60 HRC	20 - 30	0.015 - 0.025	0.025 - 0.07	0.5xD

Semi-finishing / Shouldering ($ae = 0.1 \sim 0.4 \times D$)

ISO	Workpiece material	Hardness	Vc (m/min)	fz (mm/t)		ap
				$\phi 6 - \phi 8$	$\phi 10 - \phi 12$	
P	Carbon steel	- 300 HB	150 - 220	0.045 - 0.09	0.09 - 0.11	2xD
	Alloy steel	- 300 HB	70 - 160	0.03 - 0.075	0.06 - 0.1	2xD
M	Stainless steel	- 200 HB	80 - 130	0.035 - 0.06	0.055 - 0.07	2xD
K	Cast iron	150 - 250 HB	130 - 220	0.045 - 0.075	0.06 - 0.09	2xD
N	Aluminium alloy	-	350 - 850	0.06 - 0.09	0.09 - 0.12	2xD
S	Titanium alloy	- 40 HRC	40 - 60	0.045 - 0.06	0.055 - 0.07	2xD
H	Hardened steel	- 60 HRC	30 - 70	0.02 - 0.055	0.045 - 0.07	2xD

Finishing (feed rate depending on required accuracy) / High feed machining at small width of cut ($ae = 0.05 \sim 0.1 \times D$)

ISO	Workpiece material	Hardness	Vc (m/min)	fz (mm/t)		ap
				$\phi 6 - \phi 8$	$\phi 10 - \phi 12$	
P	Carbon steel	- 300 HB	170 - 280	0.075 - 0.11	0.11 - 0.12	apmax
	Alloy steel	- 300 HB	110 - 220	0.075 - 0.11	0.11 - 0.12	apmax
M	Stainless steel	- 200 HB	100 - 160	0.045 - 0.07	0.06 - 0.075	apmax
K	Cast iron	150 - 250 HB	180 - 280	0.05 - 0.09	0.09 - 0.1	apmax
N	Aluminium alloy	-	350 - 900	0.065 - 0.11	0.11 - 0.15	apmax
S	Titanium alloy	- 40 HRC	50 - 70	0.055 - 0.075	0.06 - 0.09	apmax
H	Hardened steel	- 60 HRC	40 - 80	0.03 - 0.06	0.05 - 0.09	apmax

- When the depth of cut (ae) is closer to the upper limit, please start with a lower limit value of cutting speed (Vc).
- While air blow is recommended, water-soluble coolant will be good for stainless steel, titanium alloy, and heat-resistant alloy.
- When chattering occurs with low rigid machines or settings, reduce cutting speed and feed at an equal rate.
- When chattering occurs with long tool overhang, reduce cutting speed and feed by 20 to 40%.

TECC**A/B2

2 flute slotting endmill, 30° or 45° helix angle

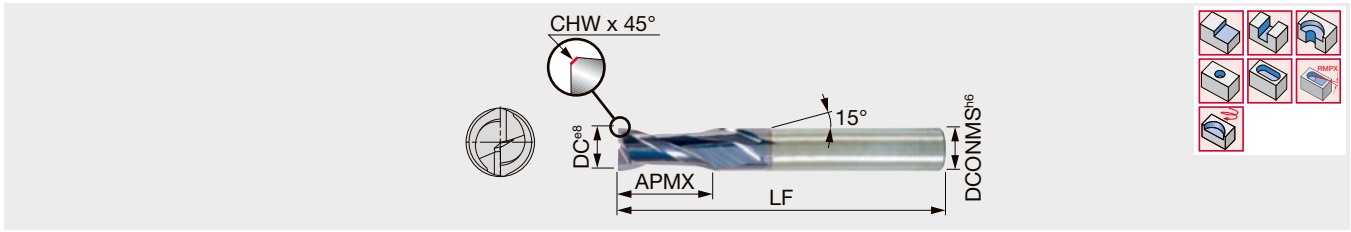

Designation	AH725	DC	DCONMS	NOF	CHW	APMX	LF	FHA	Shank
TECC020B2-07C03-38	●	2	3	2	0.1	7	38	45°	Cylindrical
TECC030A2-10C03-38	●	3	3	2	0.1	10	38	30°	Cylindrical
TECC040A2-12C04-50	●	4	4	2	0.1	12	50	30°	Cylindrical
TECC050A2-14C05-50	●	5	5	2	0.15	14	50	30°	Cylindrical
TECC060A2-16C06-57	●	6	6	2	0.15	16	57	30°	Cylindrical
TECC080A2-20C08-63	●	8	8	2	0.15	20	63	30°	Cylindrical
TECC100A2-22C10-72	●	10	10	2	0.15	22	72	30°	Cylindrical
TECC120A2-25C12-83	●	12	12	2	0.25	25	83	30°	Cylindrical

● : Line up

TECS/TECCS**E3

3 flute slotting endmill, 38° helix angle, short type

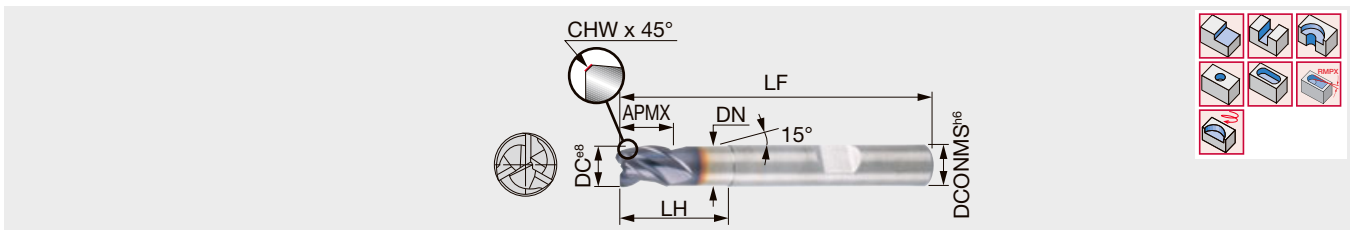

Designation	AH725	DC	DCONMS	NOF	CHW	DN	APMX	LH	LF	Shank
TECS020E3-03W06-57	●	2	6	3	0.1	1.9	3	7	57	Weldon
TECS030E3-04W06-57	●	3	6	3	0.1	2.9	4	10	57	Weldon
TECS040E3-05W06-57	●	4	6	3	0.1	3.9	5	12	57	Weldon
TECS050E3-06W06-57	●	5	6	3	0.15	4.9	6	14	57	Weldon
TECCS060E3-07W06-57	●	6	6	3	0.15	5.9	7	16	57	Weldon
TECCS080E3-09W08-63	●	8	8	3	0.15	7.6	9	20	63	Weldon
TECCS100E3-11W10-72	●	10	10	3	0.15	9.5	11	22	72	Weldon
TECCS120E3-12W12-83	●	12	12	3	0.25	11.3	12	25	83	Weldon

● : Line up

TECC**E3

3 flute slotting endmill, 38° helix angle

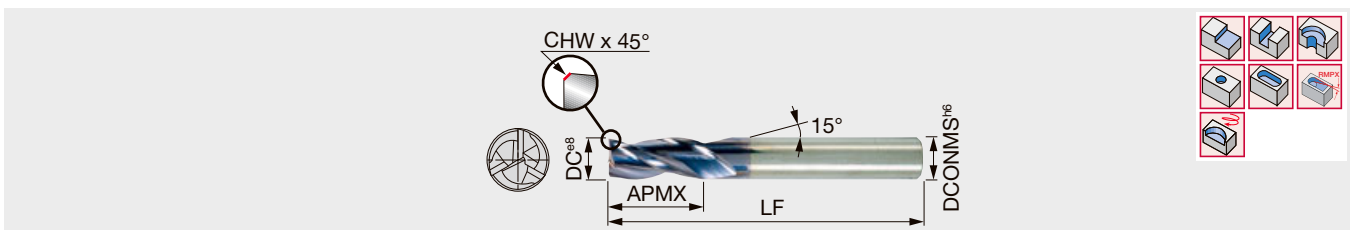

Designation	AH725	DC	DCONMS	NOF	CHW	APMX	LF	FHA	Shank
TECC040E3-12C04-50	●	4	4	3	0.1	12	50	38°	Cylindrical
TECC050E3-14C05-50	●	5	5	3	0.15	14	50	38°	Cylindrical
TECC060E3-16C06-57	●	6	6	3	0.15	16	57	38°	Cylindrical
TECC080E3-20C08-63	●	8	8	3	0.15	20	63	38°	Cylindrical
TECC100E3-22C10-72	●	10	10	3	0.15	22	72	38°	Cylindrical
TECC120E3-25C12-83	●	12	12	3	0.25	25	83	38°	Cylindrical

● : Line up

Reference pages: Standard cutting conditions → [8-29](#)

3 flute slotting endmill, 45° helix angle

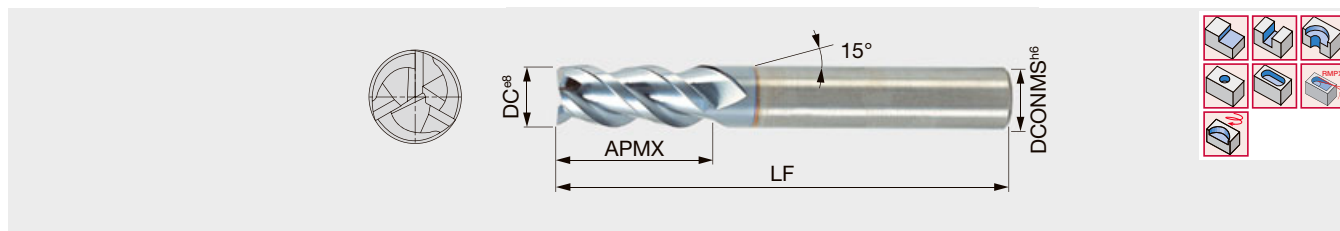

Designation	AH725	DC	NOF	DCONMS	APMX	LF	Shank
TEC060B3-16C06-57	●	6	3	6	16	57	Cylindrical
TEC080B3-20C08-63	●	8	3	8	20	63	Cylindrical
TEC090B3-20C09-67	●	9	3	9	20	67	Cylindrical
TEC100B3-22C10-72	●	10	3	10	22	72	Cylindrical
TEC120B3-25C12-83	●	12	3	12	25	83	Cylindrical

● : Line up

TECC**A/B4

4 flute endmill, 30° or 45° helix angle

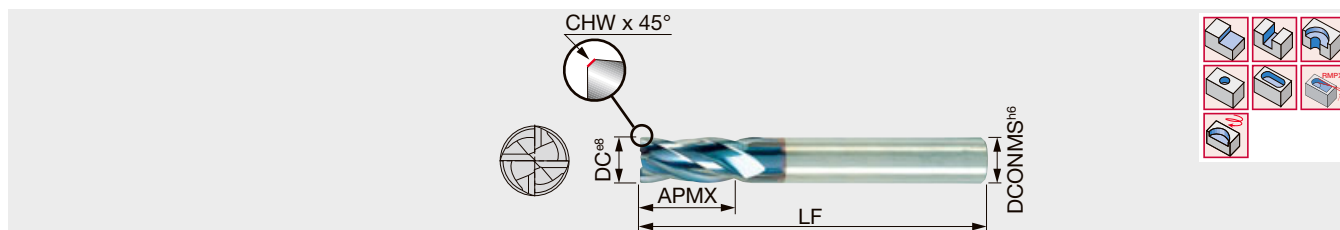

Designation	AH725	DC	DCONMS	NOF	CHW	APMX	LF	FHA	Shank
TECC020B4-07C03-38	●	2	3	4	0.1	7	38	45°	Cylindrical
TECC030A4-10C03-38	●	3	3	4	0.1	10	38	30°	Cylindrical
TECC040A4-12C04-50	●	4	4	4	0.1	12	50	30°	Cylindrical
TECC050A4-14C05-50	●	5	5	4	0.15	14	50	30°	Cylindrical
TECC060A4-16C06-57	●	6	6	4	0.15	16	57	30°	Cylindrical
TECC080A4-20C08-63	●	8	8	4	0.15	20	63	30°	Cylindrical
TECC100A4-22C10-72	●	10	10	4	0.15	22	72	30°	Cylindrical
TECC120A4-25C12-83	●	12	12	4	0.25	25	83	30°	Cylindrical

● : Line up

TEC**B4

4 flute endmill, 45° helix angle

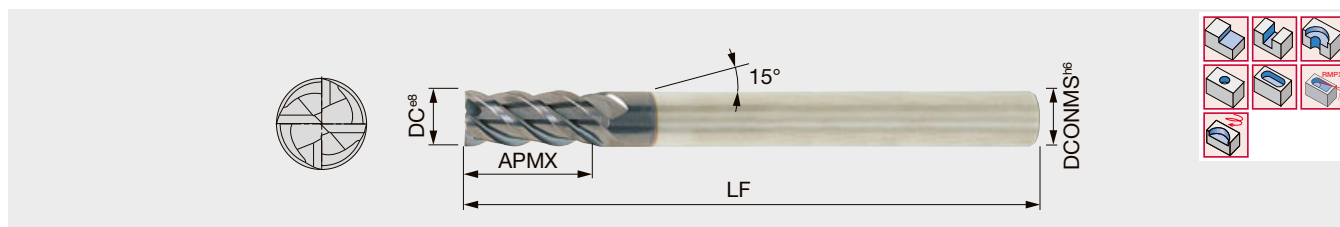

Designation	AH725	DC	DCONMS	NOF	APMX	LF	Shank
TEC020B4-07C06-57	●	2	6	4	7	57	Cylindrical
TEC030B4-10C06-57	●	3	6	4	10	57	Cylindrical
TEC040B4-12C06-57	●	4	6	4	12	57	Cylindrical
TEC050B4-14C06-57	●	5	6	4	14	57	Cylindrical
TEC060B4-16C06-57	●	6	6	4	16	57	Cylindrical
TEC080B4-20C08-63	●	8	8	4	20	63	Cylindrical
TEC100B4-22C10-72	●	10	10	4	22	72	Cylindrical
TEC120B4-25C12-83	●	12	12	4	25	83	Cylindrical

● : Line up

TEC**B4**R

4 flute radius endmill, 45° helix angle

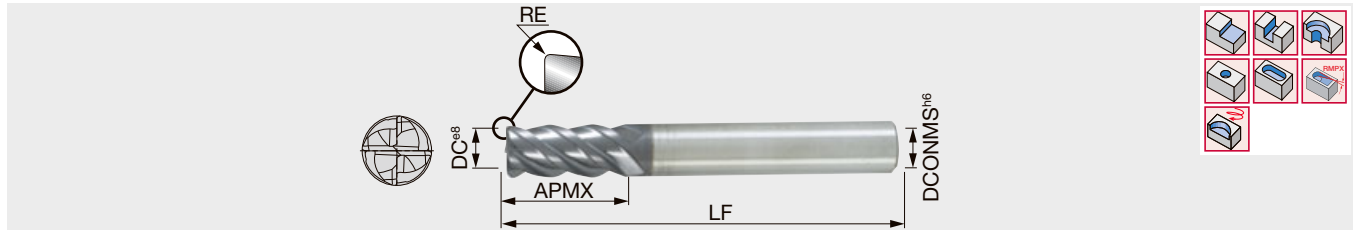

Designation	AH725	DC	DCONMS	NOF	RE	APMX	LF	Shank
TEC060B4-16C06R05-57	●	6	6	4	0.5	16	57	Cylindrical
TEC060B4-16C06R1-57	●	6	6	4	1	16	57	Cylindrical
TEC080B4-20C08R05-63	●	8	8	4	0.5	20	63	Cylindrical
TEC080B4-20C08R1-63	●	8	8	4	1	20	63	Cylindrical
TEC080B4-20C08R15-63	●	8	8	4	1.5	20	63	Cylindrical
TEC080B4-20C08R2-63	●	8	8	4	2	20	63	Cylindrical
TEC100B4-22C10R05-72	●	10	10	4	0.5	22	72	Cylindrical
TEC100B4-22C10R1-72	●	10	10	4	1	22	72	Cylindrical
TEC100B4-22C10R15-72	●	10	10	4	1.5	22	72	Cylindrical
TEC100B4-22C10R2-72	●	10	10	4	2	22	72	Cylindrical
TEC100B4-22C10R3-72	●	10	10	4	3	22	72	Cylindrical
TEC120B4-25C12R05-83	●	12	12	4	0.5	25	83	Cylindrical
TEC120B4-25C12R1-83	●	12	12	4	1	25	83	Cylindrical
TEC120B4-25C12R15-83	●	12	12	4	1.5	25	83	Cylindrical
TEC120B4-25C12R2-83	●	12	12	4	2	25	83	Cylindrical
TEC120B4-25C12R3-83	●	12	12	4	3	25	83	Cylindrical

● : Line up

Grade

Insert

Ext. Toolholder

Int. Toolholder

Threading

Grooving

Shaper

Endmill

Drilling Tool

Technical Reference

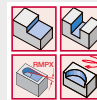
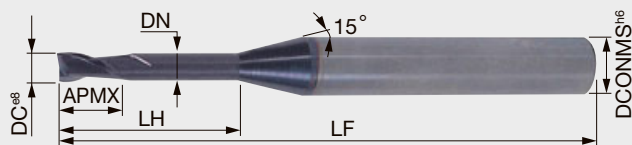

Designation	AH750	DC	DCONMS	NOF	DN	APMX	LH	LF	Shank
TEC004A2-006/02C4M45	●	0.4	4	2	0.37	0.6	2	45	Cylindrical
TEC004A2-006/04C4M45	●	0.4	4	2	0.37	0.6	4	45	Cylindrical
TEC005A2-007/02C4M45	●	0.5	4	2	0.45	0.7	2	45	Cylindrical
TEC005A2-007/04C4M45	●	0.5	4	2	0.45	0.7	4	45	Cylindrical
TEC005A2-007/06C4M45	●	0.5	4	2	0.45	0.7	6	45	Cylindrical
TEC006A2-009/02C4M45	●	0.6	4	2	0.55	0.9	2	45	Cylindrical
TEC006A2-009/04C4M45	●	0.6	4	2	0.55	0.9	4	45	Cylindrical
TEC006A2-009/06C4M45	●	0.6	4	2	0.55	0.9	6	45	Cylindrical
TEC007A2-010/02C4M45	●	0.7	4	2	0.65	1	2	45	Cylindrical
TEC008A2-012/04C4M45	●	0.8	4	2	0.75	1.2	4	45	Cylindrical
TEC008A2-012/06C4M45	●	0.8	4	2	0.75	1.2	6	45	Cylindrical
TEC008A2-012/08C4M45	●	0.8	4	2	0.75	1.2	8	45	Cylindrical
TEC009A2-0135/06C4M45	●	0.9	4	2	0.85	1.35	6	45	Cylindrical
TEC009A2-0135/10C4M45	●	0.9	4	2	0.85	1.35	10	45	Cylindrical
TEC010A2-015/04C4M45	●	1	4	2	0.97	1.5	4	45	Cylindrical
TEC010A2-015/06C4M45	●	1	4	2	0.97	1.5	6	45	Cylindrical
TEC010A2-015/08C4M45	●	1	4	2	0.95	1.5	8	45	Cylindrical
TEC010A2-015/10C4M45	●	1	4	2	0.95	1.5	10	45	Cylindrical
TEC010A2-015/12C4M45	●	1	4	2	0.93	1.5	12	45	Cylindrical
TEC010A2-015/16C4M50	●	1	4	2	0.93	1.5	16	50	Cylindrical
TEC012A2-018/06C4M45	●	1.2	4	2	1.17	1.8	6	45	Cylindrical
TEC012A2-018/08C4M45	●	1.2	4	2	1.15	1.8	8	45	Cylindrical
TEC012A2-018/10C4M45	●	1.2	4	2	1.15	1.8	10	45	Cylindrical
TEC012A2-018/16C4M50	●	1.2	4	2	1.13	1.8	16	50	Cylindrical
TEC014A2-021/06C4M45	●	1.4	4	2	1.35	2.1	6	45	Cylindrical
TEC014A2-021/08C4M45	●	1.4	4	2	1.35	2.1	8	45	Cylindrical
TEC014A2-021/10C4M45	●	1.4	4	2	1.35	2.1	10	45	Cylindrical
TEC015A2-023/06C4M45	●	1.5	4	2	1.47	2.3	6	45	Cylindrical
TEC015A2-023/08C4M45	●	1.5	4	2	1.45	2.3	8	45	Cylindrical
TEC015A2-023/10C4M45	●	1.5	4	2	1.45	2.3	10	45	Cylindrical
TEC015A2-023/12C4M45	●	1.5	4	2	1.43	2.3	12	45	Cylindrical
TEC015A2-023/16C4M50	●	1.5	4	2	1.41	2.3	16	50	Cylindrical
TEC015A2-023/18C4M55	●	1.5	4	2	1.41	2.3	18	55	Cylindrical
TEC015A2-023/20C4M55	●	1.5	4	2	1.41	2.3	20	55	Cylindrical
TEC016A2-024/06C4M45	●	1.6	4	2	1.57	2.4	6	45	Cylindrical
TEC016A2-024/08C4M45	●	1.6	4	2	1.55	2.4	8	45	Cylindrical
TEC016A2-024/10C4M45	●	1.6	4	2	1.55	2.4	10	45	Cylindrical
TEC016A2-024/18C4M55	●	1.6	4	2	1.53	2.4	18	55	Cylindrical
TEC016A2-024/20C4M55	●	1.6	4	2	1.53	2.4	20	55	Cylindrical
TEC016A2-024/26C4M60	●	1.6	4	2	1.53	2.4	26	60	Cylindrical
TEC018A2-027/06C4M45	●	1.8	4	2	1.77	2.7	6	45	Cylindrical
TEC018A2-027/08C4M45	●	1.8	4	2	1.75	2.7	8	45	Cylindrical
TEC018A2-027/10C4M45	●	1.8	4	2	1.75	2.7	10	45	Cylindrical
TEC018A2-027/12C4M45	●	1.8	4	2	1.73	2.7	12	45	Cylindrical
TEC020A2-030/06C4M45	●	2	4	2	1.97	3	6	45	Cylindrical
TEC020A2-030/08C4M45	●	2	4	2	1.95	3	8	45	Cylindrical
TEC020A2-030/10C4M45	●	2	4	2	1.95	3	10	45	Cylindrical
TEC020A2-030/12C4M45	●	2	4	2	1.93	3	12	45	Cylindrical
TEC020A2-030/16C4M50	●	2	4	2	1.91	3	16	50	Cylindrical

● : Line up

Designation	AH750	DC	DCONMS	NOF	DN	APMX	LH	LF	Shank
TEC020A2-030/20C4M55	●	2	4	2	1.89	3	20	55	Cylindrical
TEC020A2-030/30C4M70	●	2	4	2	1.89	3	30	70	Cylindrical
TEC025A2-037/08C4M45	●	2.5	4	2	2.4	3.7	8	45	Cylindrical
TEC025A2-037/10C4M45	●	2.5	4	2	2.4	3.7	10	45	Cylindrical
TEC025A2-037/12C4M45	●	2.5	4	2	2.4	3.7	12	45	Cylindrical
TEC025A2-037/16C4M55	●	2.5	4	2	2.4	3.7	16	55	Cylindrical
TEC025A2-037/20C4M60	●	2.5	4	2	2.4	3.7	20	60	Cylindrical
TEC025A2-037/30C4M80	●	2.5	4	2	2.4	3.7	30	80	Cylindrical
TEC030A2-045/08C6M45	●	3	6	2	2.85	4.5	8	45	Cylindrical
TEC030A2-045/10C6M45	●	3	6	2	2.85	4.5	10	45	Cylindrical
TEC030A2-045/12C6M45	●	3	6	2	2.85	4.5	12	45	Cylindrical
TEC030A2-045/16C6M55	●	3	6	2	2.85	4.5	16	55	Cylindrical
TEC030A2-045/20C6M60	●	3	6	2	2.85	4.5	20	60	Cylindrical
TEC030A2-045/30C6M70	●	3	6	2	2.85	4.5	30	70	Cylindrical
TEC030A2-045/40C6M90	●	3	6	2	2.85	4.5	40	90	Cylindrical

● : Line up

SOLIDMEISTER

TEC**A4

4 flute endmill, 30° helix angle, for hardened steel up to 65 HRC

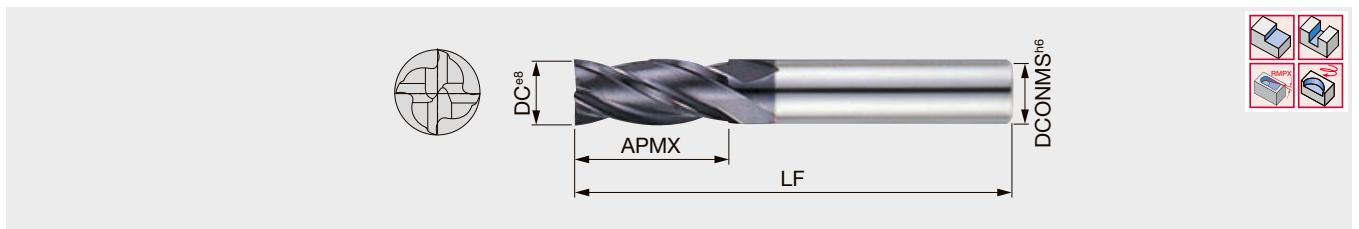

Designation	AH750	DC	DCONMS	NOF	APMX	LF	Shank
TEC040A4-11C06-50	●	4	6	4	11	50	Cylindrical
TEC050A4-13C06-50	●	5	6	4	13	50	Cylindrical
TEC060A4-13C06-50	●	6	6	4	13	50	Cylindrical
TEC070A4-16C08-63	●	7	8	4	16	63	Cylindrical
TEC080A4-19C08-63	●	8	8	4	19	63	Cylindrical
TEC090A4-19C10-72	●	9	10	4	19	72	Cylindrical
TEC100A4-22C10-72	●	10	10	4	22	72	Cylindrical
TEC120A4-26C12-73	●	12	12	4	26	73	Cylindrical

● : Line up

TECA**B2

2 flute slotting endmill, 45° helix angle, for aluminium machining

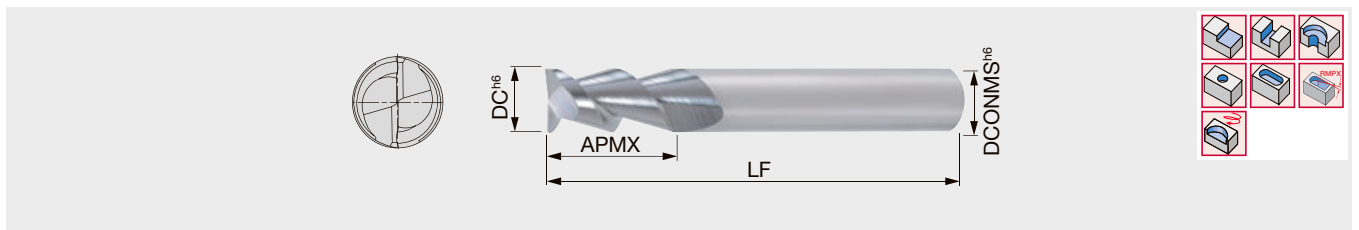

Designation	KS15F	DC	DCONMS	NOF	APMX	LF	Shank
TECA040B2-12C06-57	●	4	6	2	12	57	Cylindrical
TECA050B2-14C06-57	●	5	6	2	14	57	Cylindrical
TECA060B2-16C06-57	●	6	6	2	16	57	Cylindrical
TECA080B2-20C08-63	●	8	8	2	20	63	Cylindrical
TECA100B2-22C10-72	●	10	10	2	22	72	Cylindrical
TECA120B2-25C12-83	●	12	12	2	25	83	Cylindrical

● : Line up

Reference pages: Standard cutting conditions → 8-29

Grade
Insert
Ext. Toolholder
Int. Toolholder
Threading
Grooving
Shaper
Endmill
Drilling Tool
Technical Reference

1
2
3
4
5
6
7
8
9
10

3 flute endmill, 45° helix angle, for aluminium machining

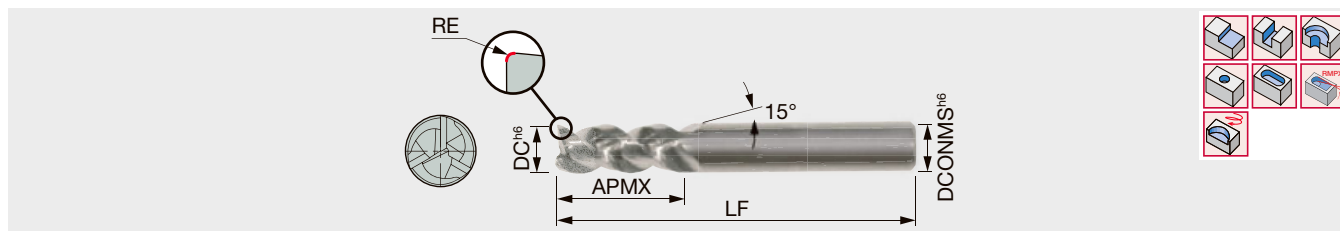

Designation	KS15F	DC	DCONMS	NOF	RE	APMX	LF	Shank
TECA040B3-12C06-57	●	4	6	3	0.1	12	57	Cylindrical
TECA040B3-12W06-57	●	4	6	3	0.1	12	57	Weldon
TECA050B3-14C06-57	●	5	6	3	0.2	14	57	Cylindrical
TECA050B3-14W06-57	●	5	6	3	0.2	14	57	Weldon
TECA060B3-16C06-57	●	6	6	3	0.2	16	57	Cylindrical
TECA060B3-16W06-57	●	6	6	3	0.2	16	57	Weldon
TECA080B3-20C08-63	●	8	8	3	0.2	20	63	Cylindrical
TECA080B3-20C08R30-63	●	8	8	3	3	20	63	Cylindrical
TECA080B3-20W08-63	●	8	8	3	0.2	20	63	Weldon
TECA100B3-22C10-72	●	10	10	3	0.2	22	72	Cylindrical
TECA100B3-22W10-72	●	10	10	3	0.2	22	72	Weldon
TECA100B3-25C10R30-72	●	10	10	3	3	25	72	Cylindrical
TECA100B3-25C10R40-72	●	10	10	3	4	25	72	Cylindrical
TECA120B3-25C12-83	●	12	12	3	0.2	25	83	Cylindrical
TECA120B3-25W12-83	●	12	12	3	0.2	25	83	Weldon
TECA120B3-30C12R30-83	●	12	12	3	3	30	83	Cylindrical
TECA120B3-30C12R40-83	●	12	12	3	4	30	83	Cylindrical

● : Line up

TECA**F2

2 flute slotting endmill, 55° helix angle, for aluminium machining

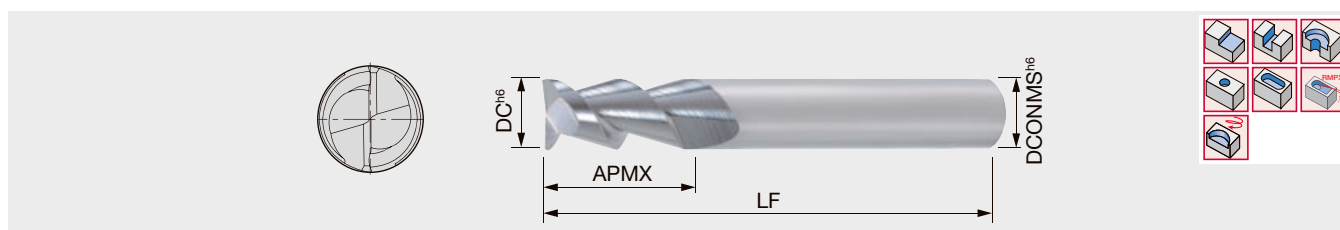

Designation	KS15F	DC	DCONMS	NOF	APMX	LF	Shank
TECA040F2-11C04-50	●	4	4	2	11	50	Cylindrical
TECA060F2-13C06-57	●	6	6	2	13	57	Cylindrical
TECA080F2-20C08-63	●	8	8	2	20	63	Cylindrical
TECA100F2-22C10-72	●	10	10	2	22	72	Cylindrical
TECA120F2-25C12-83	●	12	12	2	25	83	Cylindrical

● : Line up

3 flute endmill, 30° or 38° helix angle, short type

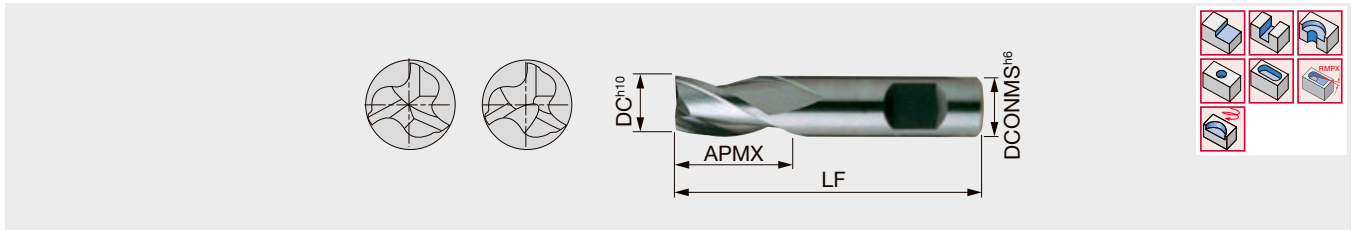

Designation	AH725	DC	DCONMS	NOF	APMX	LF	FHA	Shank
TEC020E3-04C06-E35	●	2	6	3	4	35	38°	Cylindrical
TEC025E3-05C06-E36	●	2.5	6	3	5	36	38°	Cylindrical
TEC030E3-05C06-E36	●	3	6	3	5	36	38°	Cylindrical
TEC035A3-06W06-E37	●	3.5	6	3	6	37	30°	Weldon
TEC040E3-07C06-E39	●	4	6	3	7	39	38°	Cylindrical
TEC045A3-08W06-E38	●	4.5	6	3	8	38	30°	Weldon
TEC050A3-08C06-E39	●	5	6	3	8	39	30°	Cylindrical
TEC055A3-08W06-E39	●	5.5	6	3	8	39	30°	Weldon
TEC060E3-08C06-E39	●	6	6	3	8	39	38°	Cylindrical
TEC070A3-10W08-E42	●	7	8	3	10	42	30°	Weldon
TEC080E3-11C08-E43	●	8	8	3	11	43	38°	Cylindrical
TEC090A3-11W10-E48	●	9	10	3	11	48	30°	Weldon
TEC100E3-13C10-E50	●	10	10	3	13	50	38°	Cylindrical

● : Line up

TEC**A/E3**E

3 flute endmill, 30° or 38° helix angle

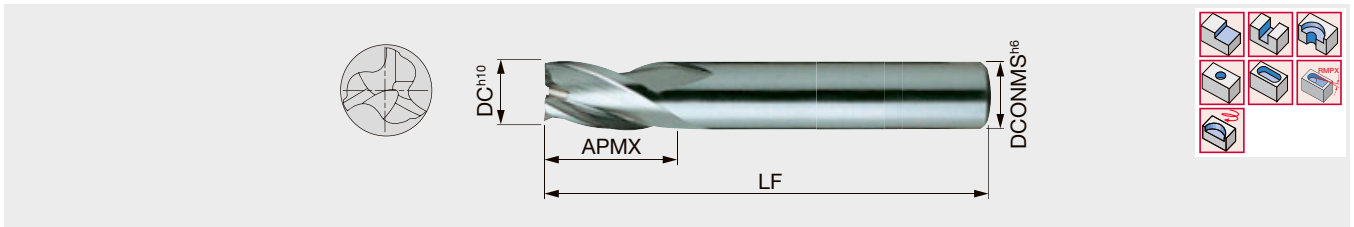

Designation	AH725	DC	DCONMS	NOF	APMX	LF	FHA	Shank
TEC020E3-08C02-E32	●	2	2	3	8	32	38°	Cylindrical
TEC030E3-12C03-E38	●	3	3	3	12	38	38°	Cylindrical
TEC040E3-12C04-E50	●	4	4	3	12	50	38°	Cylindrical
TEC050E3-14C05-E50	●	5	5	3	14	50	38°	Cylindrical
TEC060E3-16C06-E50	●	6	6	3	16	50	38°	Cylindrical
TEC070E3-20C07-E60	●	7	7	3	20	60	38°	Cylindrical
TEC080E3-20C08-E63	●	8	8	3	20	63	38°	Cylindrical
TEC090A3-20C09-E60	●	9	9	3	20	60	30°	Cylindrical
TEC100E3-22C10-E72	●	10	10	3	22	72	38°	Cylindrical
TEC120E3-22C12-E73	●	12	12	3	22	73	38°	Cylindrical

● : Line up

TEC**B3**W

3 flute endmill, 45° helix angle, short type

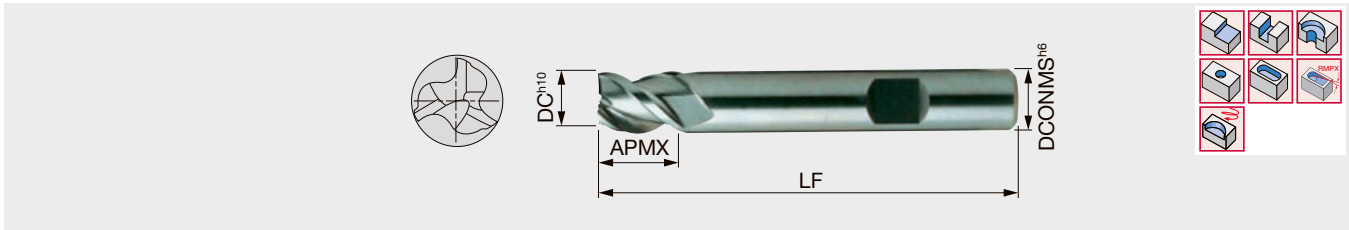

Designation	AH725	DC	DCONMS	NOF	APMX	LF	Shank
TEC020B3-03W06-50	●	2	6	3	3	50	Weldon
TEC030B3-04W06-50	●	3	6	3	4	50	Weldon
TEC040B3-05W06-54	●	4	6	3	5	54	Weldon
TEC050B3-06W06-54	●	5	6	3	6	54	Weldon
TEC060B3-07W06-54	●	6	6	3	7	54	Weldon
TEC080B3-09W08-58	●	8	8	3	9	58	Weldon
TEC100B3-11W10-66	●	10	10	3	11	66	Weldon
TEC120B3-12W12-73	●	12	12	3	12	73	Weldon

● : Line up

TEC**A4**E

4 flute endmill, 30° helix angle

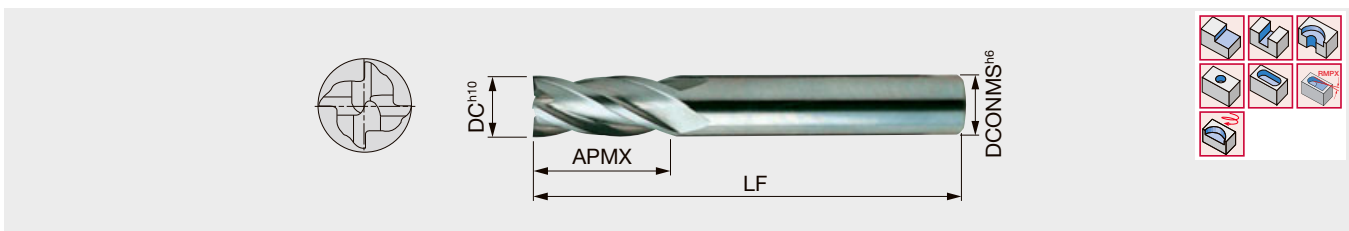

Designation	AH725	DC	DCONMS	NOF	APMX	LF	Shank
TEC020A4-08C02-E32	●	2	2	4	8	32	Cylindrical
TEC025A4-08C025-E32	●	2.5	2.5	4	8	32	Cylindrical
TEC030A4-12C03-E38	●	3	3	4	12	38	Cylindrical
TEC040A4-12C04-E50	●	4	4	4	12	50	Cylindrical
TEC050A4-14C05-E50	●	5	5	4	14	50	Cylindrical
TEC055A4-16C055-E50	●	5.5	5.5	4	16	50	Cylindrical
TEC060A4-16C06-E50	●	6	6	4	16	50	Cylindrical
TEC070A4-20C07-E60	●	7	7	4	20	60	Cylindrical
TEC080A4-20C08-E60	●	8	8	4	20	60	Cylindrical
TEC090A4-20C09-E60	●	9	9	4	20	60	Cylindrical
TEC100A4-22C10-E72	●	10	10	4	22	72	Cylindrical
TEC120A4-22C12-E73	●	12	12	4	22	73	Cylindrical

● : Line up

Reference pages: Standard cutting conditions → [8-29](#)

STANDARD CUTTING CONDITIONS

Slotting / Roughing

ISO	Workpiece material	Hardness	Vc (m/min)	fz (mm/t)		ap (Slotting)
				ø6 - ø8	ø10 - ø12	
P	Carbon steel	- 300 HB	140 - 180	0.025 - 0.035	0.03 - 0.045	1xD
	Alloy steel	- 300 HB	70 - 150	0.02 - 0.03	0.03 - 0.045	1xD
M	Stainless steel	- 200 HB	60 - 100	0.02 - 0.035	0.03 - 0.04	0.5xD
K	Cast iron	150 - 250 HB	80 - 180	0.02 - 0.04	0.03 - 0.05	1xD
N	Aluminium alloy	-	300 - 750	0.02 - 0.04	0.03 - 0.05	1xD
S	Titanium alloy	-	20 - 50	0.02 - 0.03	0.025 - 0.04	0.25xD
H	Hardened steel	- 60 HRC	20 - 30	0.01 - 0.015	0.02 - 0.045	0.2xD

Semi-finishing / Shouldering (ae = 0.1-0.4 x D)

ISO	Workpiece material	Hardness	Vc (m/min)	fz (mm/t)		ap
				ø6 - ø8	ø10 - ø12	
P	Carbon steel	- 300 HB	150 - 220	0.03 - 0.06	0.06 - 0.07	2xD
	Alloy steel	- 300 HB	70 - 160	0.02 - 0.05	0.04 - 0.065	2xD
M	Stainless steel	- 200 HB	80 - 130	0.025 - 0.04	0.035 - 0.045	2xD
K	Cast iron	150 - 250 HB	130 - 220	0.03 - 0.05	0.04 - 0.06	2xD
N	Aluminium alloy	-	350 - 850	0.04 - 0.06	0.06 - 0.08	2xD
S	Titanium alloy	-	40 - 60	0.03 - 0.04	0.035 - 0.05	2xD
H	Hardened steel	- 60 HRC	30 - 70	0.015 - 0.035	0.035 - 0.055	2xD

Finishing (feed rate depending on required accuracy) / High feed machining at low depth of cut (ae = 0.05-0.1 x D)

ISO	Workpiece material	Hardness	Vc (m/min)	fz (mm/t)		ap
				ø6 - ø8	ø10 - ø12	
P	Carbon steel	- 300 HB	170 - 280	0.05 - 0.07	0.07 - 0.08	apmax
	Alloy steel	- 300 HB	110 - 220	0.05 - 0.07	0.07 - 0.08	apmax
M	Stainless steel	- 200 HB	100 - 160	0.03 - 0.045	0.04 - 0.05	apmax
K	Cast iron	150 - 250 HB	180 - 280	0.035 - 0.06	0.06 - 0.065	apmax
N	Aluminium alloy	-	350 - 900	0.045 - 0.07	0.07 - 0.1	apmax
S	Titanium alloy	-	50 - 70	0.035 - 0.05	0.04 - 0.06	apmax
H	Hardened steel	- 60 HRC	40 - 80	0.02 - 0.04	0.04 - 0.06	apmax

- When the depth of cut (ae) is closer to the upper limit, please start with a lower limit value of cutting speed (Vc).
- The items with long slot (2xD or over) and the items with 5 cutting edges or more are not suitable for slotting operation.
- When using AH750, reducing cutting speed by 20 to 30% is effective for extending tool life.
- While air blow is recommended, water-soluble coolant will be good for stainless steel, titanium alloy, and heat-resistant alloy.
- When chattering occurs with low rigid machines or settings, reduce cutting speed and feed at an equal rate.
- When chattering occurs with long tool overhang, reduce cutting speed and feed by 20 to 40% (Variable/FinishMeister is recommended for such operations).
- In slotting of high hardened steel, heat-resistant alloy, and some types of stainless steel, start with ap=0.2xD and increase the value gradually while checking the status of the operation.
- In shoulder milling of high hardened steel and heat-resistant alloy, the cutting width should be started at ae=0.05xD and increase the value gradually while checking the status of the operation.
- The items with many cutting edges are good for finishing and high feed machining of small width of cut.
- VariableMeister is suitable for machining large depth of cut.
- Low feed in finishing is recommended for good surface roughness.

2 flute ball nose rib processing endmill, 30° helix angle, for hardened steel

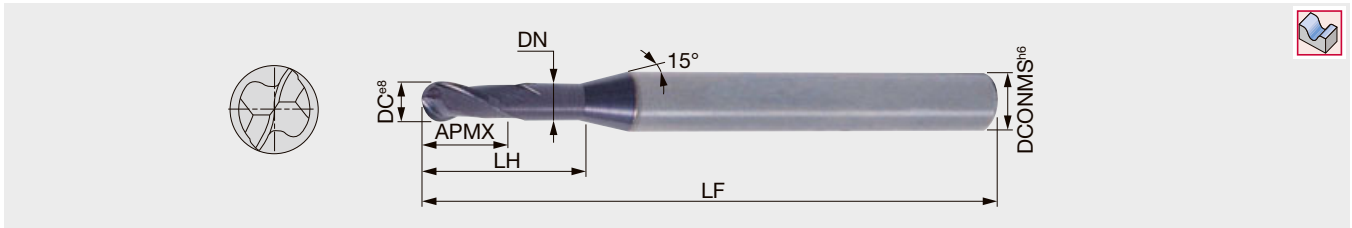

Designation	AH750	DC	DCONMS	NOF	DN	APMX	LH	LF	Shank
TEB004A2-006/02C4M45	●	0.4	4	2	0.36	0.6	2	45	Cylindrical
TEB004A2-006/03C4M45	●	0.4	4	2	0.36	0.6	3	45	Cylindrical
TEB005A2-007/02C4M45	●	0.5	4	2	0.45	0.7	2	45	Cylindrical
TEB005A2-007/04C4M45	●	0.5	4	2	0.45	0.7	4	45	Cylindrical
TEB005A2-007/06C4M45	●	0.5	4	2	0.45	0.7	6	45	Cylindrical
TEB006A2-009/02C4M45	●	0.6	4	2	0.55	0.9	2	45	Cylindrical
TEB006A2-009/04C4M45	●	0.6	4	2	0.55	0.9	4	45	Cylindrical
TEB008A2-012/04C4M45	●	0.8	4	2	0.75	1.2	4	45	Cylindrical
TEB008A2-012/06C4M45	●	0.8	4	2	0.75	1.2	6	45	Cylindrical
TEB010A2-015/04C4M45	●	1	4	2	0.97	1.5	4	45	Cylindrical
TEB010A2-015/06C4M45	●	1	4	2	0.97	1.5	6	45	Cylindrical
TEB010A2-015/08C4M45	●	1	4	2	0.95	1.5	8	45	Cylindrical
TEB010A2-015/10C4M45	●	1	4	2	0.95	1.5	10	45	Cylindrical
TEB010A2-015/12C4M45	●	1	4	2	0.93	1.5	12	45	Cylindrical
TEB010A2-015/16C4M50	●	1	4	2	0.93	1.5	16	50	Cylindrical
TEB012A2-018/08C4M45	●	1.2	4	2	1.17	1.8	8	45	Cylindrical
TEB012A2-018/12C4M45	●	1.2	4	2	1.13	1.8	12	45	Cylindrical
TEB014A2-021/08C4M45	●	1.4	4	2	1.35	2.1	8	45	Cylindrical
TEB014A2-021/16C4M50	●	1.4	4	2	1.31	2.1	16	50	Cylindrical
TEB015A2-023/06C4M45	●	1.5	4	2	1.47	2.3	6	45	Cylindrical
TEB015A2-023/08C4M45	●	1.5	4	2	1.45	2.3	8	45	Cylindrical
TEB015A2-023/10C4M45	●	1.5	4	2	1.45	2.3	10	45	Cylindrical
TEB015A2-023/12C4M45	●	1.5	4	2	1.43	2.3	12	45	Cylindrical
TEB015A2-023/20C4M55	●	1.5	4	2	1.39	2.3	20	55	Cylindrical
TEB016A2-024/08C4M45	●	1.6	4	2	1.55	2.4	8	45	Cylindrical
TEB016A2-024/12C4M45	●	1.6	4	2	1.53	2.4	12	45	Cylindrical
TEB018A2-027/08C4M45	●	1.8	4	2	1.75	2.7	8	45	Cylindrical
TEB018A2-027/12C4M45	●	1.8	4	2	1.73	2.7	12	45	Cylindrical
TEB018A2-027/16C4M50	●	1.8	4	2	1.71	2.7	16	50	Cylindrical
TEB020A2-030/06C4M45	●	2	4	2	1.97	3	6	45	Cylindrical
TEB020A2-030/10C4M45	●	2	4	2	1.93	3	10	45	Cylindrical
TEB020A2-030/12C4M50	●	2	4	2	1.93	3	12	50	Cylindrical
TEB020A2-030/16C4M50	●	2	4	2	1.91	3	16	50	Cylindrical
TEB020A2-030/20C4M55	●	2	4	2	1.89	3	20	55	Cylindrical
TEB020A2-030/30C4M70	●	2	4	2	1.89	3	30	70	Cylindrical
TEB030A2-045/08C6M50	●	3	6	2	2.85	4.5	8	50	Cylindrical
TEB030A2-045/10C6M50	●	3	6	2	2.85	4.5	10	50	Cylindrical
TEB030A2-045/12C6M50	●	3	6	2	2.85	4.5	12	50	Cylindrical
TEB030A2-045/16C6M55	●	3	6	2	2.85	4.5	16	55	Cylindrical
TEB030A2-045/20C6M60	●	3	6	2	2.85	4.5	20	60	Cylindrical
TEB030A2-045/30C6M70	●	3	6	2	2.85	4.5	30	70	Cylindrical
TEB030A2-045/35C6M80	●	3	6	2	2.85	4.5	35	80	Cylindrical

● : Line up

2 flute ball nose endmill, 30° helix angle, short type, for hardened steel

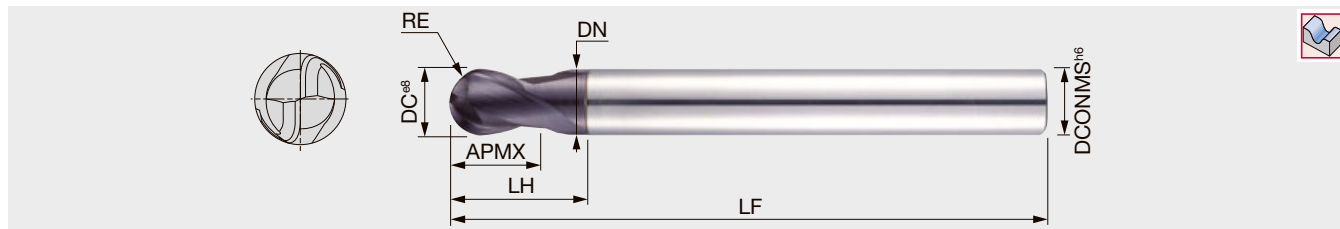

Designation	AH750	DC	DCONMS	NOF	DN	RE±0.01	APMX	LH	LF	Shank
TEB010A2-01/02C04H50	●	1	4	2	0.95	0.5	1	2.2	50	Cylindrical
TEB020A2-02/04C06H50	●	2	6	2	1.9	1	2	4	50	Cylindrical
TEB030A2-03/06C06H60	●	3	6	2	2.9	1.5	3	6	60	Cylindrical
TEB040A2-04/08C06H70	●	4	6	2	3.9	2	4	8	70	Cylindrical
TEB050A2-05/10C06H80	●	5	6	2	4.9	2.5	5	10	80	Cylindrical
TEB060A2-06/12C06H90	●	6	6	2	5.9	3	6	12	90	Cylindrical
TEB080A2-08/16C08H100	●	8	8	2	7.9	4	8	16	100	Cylindrical
TEB100A2-10/20C10H100	●	10	10	2	9.9	5	10	20	100	Cylindrical
TEB120A2-12/24C12H110	●	12	12	2	11.9	6	12	24	110	Cylindrical

● : Line up

TEB**A2-**C**M...

2 flute ball nose rib processing endmill, 30° helix angle, for hardened steel

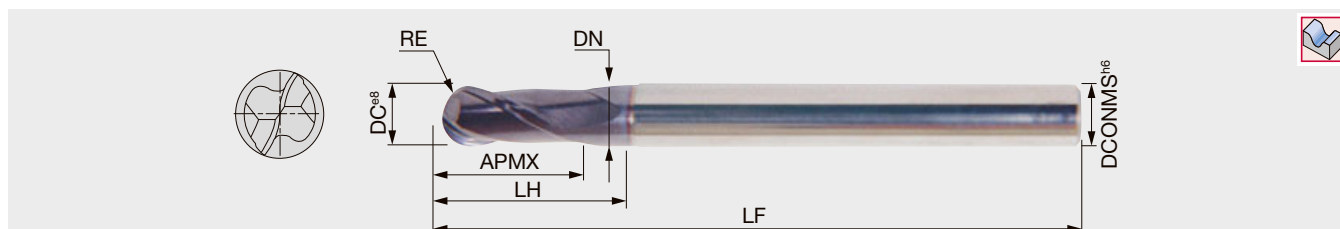

Designation	AH750	DC	DCONMS	NOF	DN	RE	APMX	LH	LF	Shank
TEB030A2-08C03M100	●	3	3	2	-	1.5	8	-	100	Cylindrical
TEB030A2-08C06M70	●	3	6	2	-	1.5	8	-	70	Cylindrical
TEB040A2-08C06M70	●	4	6	2	-	2	8	-	70	Cylindrical
TEB040A2-08C04M100	●	4	4	2	-	2	8	-	100	Cylindrical
TEB050A2-12C06M80	●	5	6	2	-	2.5	12	-	80	Cylindrical
TEB060A2-10C06M120	●	6	6	2	-	3	10	-	120	Cylindrical
TEB060A2-12/22C06M80	●	6	6	2	5.8	3	12	22	80	Cylindrical
TEB080A2-14/27C08M90	●	8	8	2	7.8	4	14	27	90	Cylindrical
TEB100A2-18/31C10M100	●	10	10	2	9.8	5	18	31	100	Cylindrical
TEB120A2-22/35C12M110	●	12	12	2	11.8	6	22	35	110	Cylindrical

● : Line up

TEBA2/**/**/**C**M...**

2 flute ball nose endmill, 30° helix angle, tapered neck type, for hardened steel

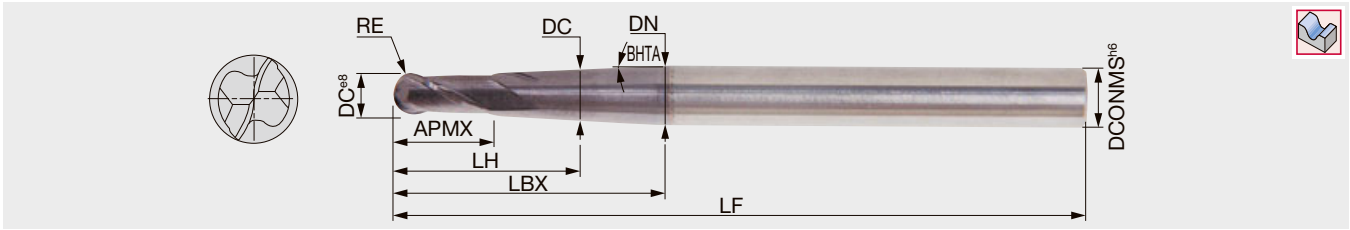

Designation	AH750	DC	DCONMS	NOF	DN	RE±0.01	APMX	LH	LBX	BHTA	LF	Shank
TEB010A2-02/04/3.0C06M80	●	1	6	2	5	0.5	2	4	42	3°	80	Cylindrical
TEB020A2-04/06/3.0C06M80	●	2	6	2	5.7	1	4	6	41	3°	80	Cylindrical
TEB030A2-06/08/3.0C06M70	●	3	6	2	5.6	1.5	6	8	32	3°	70	Cylindrical
TEB040A2-08/10/1.5C06M90	●	4	6	2	6	2	8	10	49	1.5°	90	Cylindrical
TEB050A2-10/12/1.5C08M110	●	5	8	2	7.6	2.5	10	12	61	1.5°	110	Cylindrical
TEB060A2-12/15/1.5C08M110	●	6	8	2	8	3	12	15	53	1.5°	110	Cylindrical
TEB080A2-14/17/1.5C10M120	●	8	10	2	10	4	14	17	55	1.5°	120	Cylindrical
TEB100A2-18/21/1.5C12M130	●	10	12	2	12	5	18	21	59	1.5°	130	Cylindrical

● : Line up

TEBA2-**C**-...**

2 flute ball nose endmill, 30° helix angle, short type

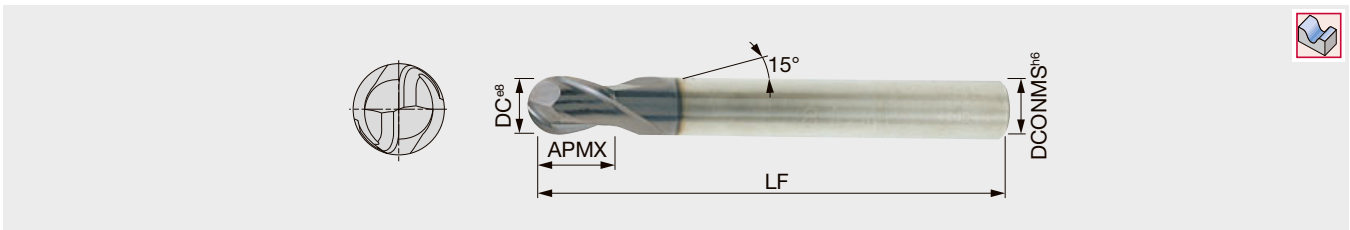

Designation	AH750	AH725	DC	DCONMS	NOF	APMX	LF	Shank
TEB030A2-05C06-57	●	●	3	6	2	5	57	Cylindrical
TEB040A2-07C06-57	●	●	4	6	2	7	57	Cylindrical
TEB050A2-08C06-57	●	●	5	6	2	8	57	Cylindrical
TEB060A2-08C06-57	●	●	6	6	2	8	57	Cylindrical
TEB080A2-11C08-63	●	●	8	8	2	11	63	Cylindrical
TEB100A2-13C10-72	●	●	10	10	2	13	72	Cylindrical
TEB120A2-14C12-83	●	●	12	12	2	14	83	Cylindrical

● : Line up

TEBA3**

3 flute ball nose endmill, 30° helix angle, short type

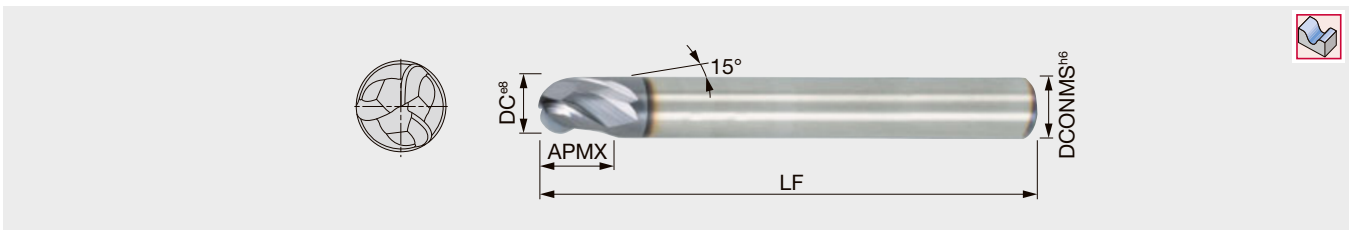

Designation	AH725	DC	DCONMS	NOF	APMX	LF	Shank
TEB030A3-05C06-57	●	3	6	3	5	57	Cylindrical
TEB040A3-07C06-57	●	4	6	3	7	57	Cylindrical
TEB050A3-08C06-57	●	5	6	3	8	57	Cylindrical
TEB060A3-08C06-57	●	6	6	3	8	57	Cylindrical
TEB080A3-11C08-63	●	8	8	3	11	63	Cylindrical
TEB100A3-13C10-72	●	10	10	3	13	72	Cylindrical
TEB120A3-14C12-83	●	12	12	3	14	83	Cylindrical

● : Line up

Reference pages: Standard cutting conditions → 8-34

4 flute ball nose endmill, 30° helix angle, short type

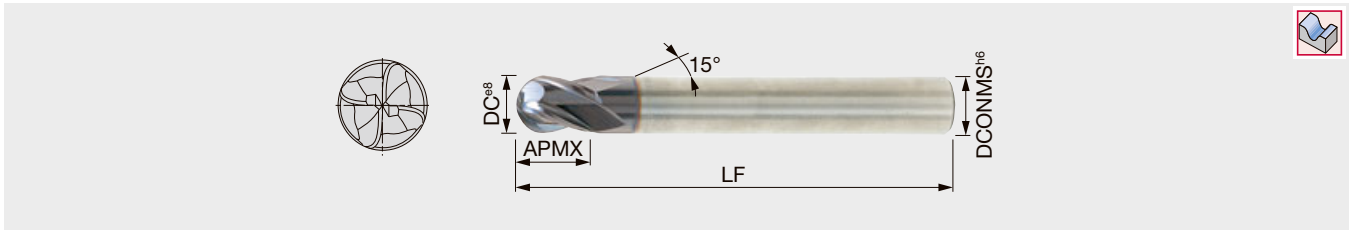

Designation	AH725	DC	DCONMS	NOF	APMX	LF	Shank
TEB030A4-05C06-57	●	3	6	4	5	57	Cylindrical
TEB040A4-07C06-50	●	4	6	4	7	50	Cylindrical
TEB050A4-08C06-57	●	5	6	4	8	57	Cylindrical
TEB060A4-08C06-57	●	6	6	4	8	57	Cylindrical
TEB080A4-11C08-63	●	8	8	4	11	63	Cylindrical
TEB100A4-13C10-72	●	10	10	4	13	72	Cylindrical
TEB120A4-14C12-83	●	12	12	4	14	83	Cylindrical

● : Line up

2 flute ball nose endmill, 30° helix angle, short type

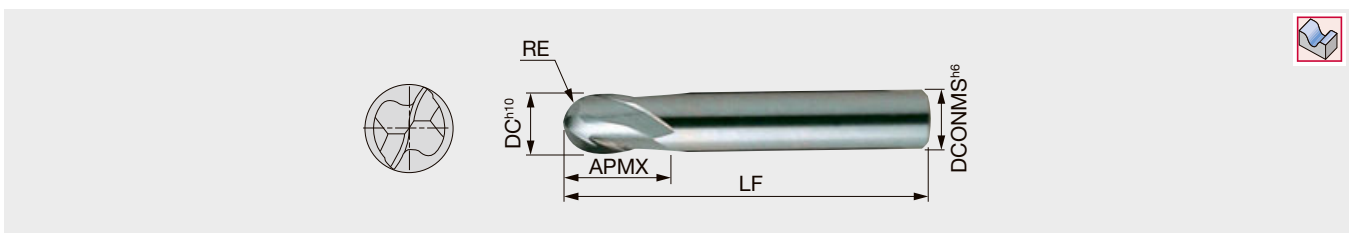

Designation	AH725	DC	DCONMS	NOF	RE	APMX	LF	Shank
TEB020A2-04C06-E48	●	2	6	2	1	4	48	Cylindrical
TEB020A2-06C03-E38	●	2	3	2	1	6	38	Cylindrical
TEB025A2-04C06-E48	●	2.5	6	2	1.25	4	48	Cylindrical
TEB030A2-04C06-E48	●	3	6	2	1.5	4	48	Cylindrical
TEB040A2-06C06-E50	●	4	6	2	2	6	50	Cylindrical
TEB040A2-08W06-E57	●	4	6	2	2	8	57	Weldon
TEB060A2-07C06-E51	●	6	6	2	3	7	51	Cylindrical
TEB060A2-10W06-E57	●	6	6	2	3	10	57	Weldon
TEB080A2-09C08-E63	●	8	8	2	4	9	63	Cylindrical
TEB100A2-10C10-E66	●	10	10	2	5	10	66	Cylindrical
TEB120A2-14C12-E71	●	12	12	2	6	14	71	Cylindrical

● : Line up

VARIABLEMEISTER SHREDMEISTER SOLIDMEISTER ECOMEISTER

STANDARD CUTTING CONDITIONS - Ball nose type

Shape machining (Roughing to semi-finishing)

ISO	Workpiece material	Hardness	Vc (m/min)	fz (mm/t)		ap
				ø3 - ø6	ø8 - ø12	
P	Carbon steel	- 300 HB	125 - 200	0.02 - 0.055	0.04 - 0.08	0.05 - 0.12xD
	Alloy steel	- 300 HB	100 - 150	0.01 - 0.035	0.03 - 0.05	0.04 - 0.1xD
M	Stainless steel	- 200 HB	110	0.015 - 0.03	0.03 - 0.04	0.05 - 0.1xD
K	Cast iron	150 - 250 HB	150 - 180	0.03 - 0.06	0.06 - 0.09	0.08 - 0.15xD
H	Hardened steel	- 49 HRC	70 - 80	0.008 - 0.02	0.025 - 0.03	0.04 - 0.08xD
	Hardened steel	50 - 60 HRC	30 - 40	0.005 - 0.008	0.007 - 0.013	0.03 - 0.06xD

Finishing











ISO	Workpiece material	Hardness	Vc (m/min)	fz (mm/t)		ap
				ø3 - ø6	ø8 - ø12	
P	Carbon steel	- 300 HB	170 - 280	0.017 - 0.046	0.034 - 0.068	0.02xD
	Alloy steel	- 300 HB	120 - 165	0.008 - 0.03	0.025 - 0.043	0.01xD
M	Stainless steel	- 200 HB	150	0.012 - 0.026	0.025 - 0.034	0.01xD
K	Cast iron	150 - 250 HB	200 - 220	0.025 - 0.051	0.051 - 0.077	0.03xD
H	Hardened steel	- 49 HRC	100	0.007 - 0.017	0.021 - 0.026	0.01xD
	Hardened steel	50 - 60 HRC	40 - 50	0.004 - 0.007	0.006 - 0.011	0.01xD

- When using AH750, reducing cutting speed by 20 to 30% is effective for extending tool life.
- While air blow is recommended, water-soluble coolant will be good for stainless steel, titanium alloy, and heat-resistant alloy.
- When chattering occurs with low rigid machines or settings, reduce cutting speed and feed at an equal rate.
- When chattering occurs with long tool overhang, reduce cutting speed and feed by 20 to 40% (VariableMeister is recommended for such operations).

Quick Guide **TUNGMEISTER**







Square, Face mill, High feed

★ : First choice ☆ : Second choice

Head geometry	Designation	Appearance	Application			Tool dia. (mm)	No. of cutting edges	Cutting edge length		Corner geometry	Helix angle	Pitch	CRKS	Workpiece material					Remarks	Page
			Roughing	Semifinishing	Finishing			L/D	APMX (mm)					P	M	N	S	H		
 Square	VEH...		✓	✓	✓	ø8 - ø12	4	0.6 - 0.8XD	5 - 9	R	Variable	Variable	S05 - S12	★	★	☆	★	☆		8-38
	VEH...		✓	✓	✓	ø8 - ø12	4	1.2 - 1.5XD	12 - 18	R	Variable	Variable	S05 - S21	★	★	☆	★	☆	Long edge	8-38
	VEE**-04... VED**-04...		✓	✓	✓	ø5 - ø12	4	0.8XD	4 - 9	R	30/45	Regular	S04 - S12	★	★	☆	★	☆	General	8-39
	VEE**I...		✓	✓	✓	ø8 - ø12	4	0.6 - 0.8XD	5 - 9	R/ Chamfered	38	Variable	S05 - S15	★	★	☆	★	☆		8-40
	VEE**-03...		✓	✓	✓	ø7.7 - ø12	3	0.5XD	4 - 9	Sharp edge	38/45	Regular	S05 - S12	★	★	☆	★	☆	For key way	8-40
	VEE**A02...		✓	✓	✓	ø10 - ø12	2	0.7XD	7 - 9	R	45	Regular	S06 - S08				★			8-40
	VEE**A03...		✓	✓	✓	ø8 - ø12	3	0.6XD	5 - 8	R	45	Regular	S05 - S12				★			8-41
	VEE**C...		✓	✓		ø8 - ø12	4	0.6 - 0.8XD	5 - 9	Chamfered	45	Regular	S05 - S15	★	★	☆	★	☆	Rough/ Finish combination geometry	8-41
 Face mill	VFM...		✓	✓	✓	ø12 - ø12	6	0.3XD	3.6 - 7.5	R	-	Variable	S05 - S10	★	★	☆	★	☆		8-44





Multi-function (chamfering, spot drill, center hole)

★ : First choice ☆ : Second choice

Head geometry	Designation	Appearance	Center edge (Z-feed capability)	Tool dia. (mm)	No. of cutting edges	Chamfering angle	Helix angle	Pitch	CRKS	Workpiece material					Remarks	Page
										P	M	N	S	H		
 Chamfering	VCA**-04/06...		Without	ø10 - ø16	4, 6	45	0	Regular	S06 - S12	★	★	☆	★	☆		8-45
 Chamfering Spot drill	VCP**-02...		With	ø8 - ø16.5	2	30/45/60	0	Regular	S05 - S10	★	★	☆	★	☆		8-46
	VDS...		With	ø8 - ø16	2	45	10	Regular	S05 - S10	★	★	☆	★	☆	Low cutting force	8-46
 Center hole	VDP**-02...		With	ø1.07 - ø6.46	2	-	0	Regular	S04 - S12	★	★	☆	★	☆	For center hole	8-48







Slotting

★ : First choice ☆ : Second choice







Head geometry	Designation	Appearance	Groove width (mm)	Tool dia. (mm)	No. of cutting edges	Edge shape	Helix angle	Pitch	CRKS	Workpiece material					Remarks	Page
										P	M	N	S	H		
	VST**-3...		1.2 - 3.17	ø15.7 - ø17.7	3	R	0	Regular	S06	★	★	☆	★	☆		8-49
	VST**-4/6...		0.76 - 10	ø21.7 - ø27.7	4, 6	R	0	Regular	S08, S10	★	★	☆	☆	☆		8-50
	VST**A45...		3.4 - 5.5	ø17.7 - ø21.7	3, 4	Chamfered	0	Regular	S06, S08	★	★	☆	★	☆	For chamfering, 45° chamfer angle	8-50

Threading

★ : First choice ☆ : Second choice

Head geometry	Designation	Appearance	Feature	Wiper edge	No. of cutting edges	Tool dia. (mm)	Internal/External	Thread type	Min. thread size	CRKS	Workpiece material					Page
											P	M	N	S	H	
	VMT***IS		Full profile	With	3 - 6	ø10 - ø16	Internal	ISO metric	M12X0.75	S05 - S08	★	★	☆	★	☆	8-52
	VMT***UN		Full profile	With	3, 4, 5	ø10 - ø16	Internal	Unified	9/16-24 UNEF	S05 - S08	★	★	☆	★	☆	8-52
	VMT***W		Full profile	With	4	ø10, 16	Internal/External	Whitworth	G1/4	S05, S08	★	★	☆	★	☆	8-53
	VTR***IS		Partial profile	Without	3, 4	ø15.7 - ø21.7	Internal/External	60° partial profile	M20X0.5	S06, S08	★	★	☆	★	☆	8-53
	VTR***W		Partial profile	Without	4	ø21.7	Internal/External	55° partial profile	G3/4	S08	★	★	☆	★	☆	8-53

Shank

Shank	Neck	Appearance	Material				Page
			Steel	Carbide	Carbide (with coolant hole)	Tungsten (with coolant hole)	
Straight	Straight		✓	✓	✓	✓	8-56
Weldon	Straight		✓	-	-	-	8-59
Straight	Taper		✓	✓	-	✓	8-58
High rigidity shank			✓	✓	-	-	8-56
Straight (slotting)			✓	✓	✓	-	8-59
Adaptor for TungFlex			✓	-	-	-	8-59
ER collet			✓	-	-	-	8-60

4 flute, roughing - finishing, variable helix and pitch

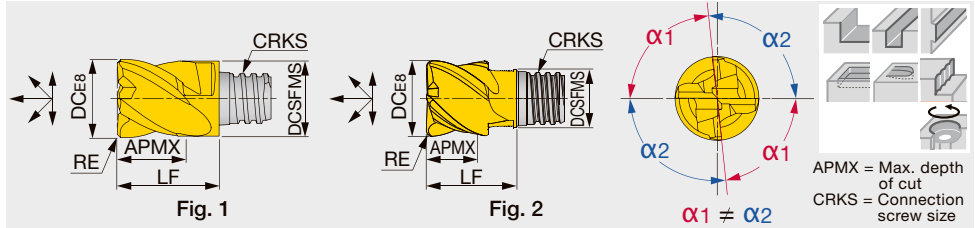

Designation	AH715	AH725	NOF	FHA	DC	DCSFMS	APMX	RE	CRKS	LF	Wrench	Torque*	Fig.
VEH080L05.0R05I04S05	●		4	41° - 45°	8	7.7	5	0.5	S05	10	KEYV-S05	7	1
VEH080L05.0R10I04S05		●	4	41° - 45°	8	7.7	5	1	S05	10	KEYV-S05	7	1
VEH100L07.0R10I04S05	●		4	41° - 45°	10	7.7	7	1	S05	12.8	KEYV-S05	7	2
VEH100L07.0R05I04S06		●	4	41° - 45°	10	9.7	7	0.5	S06	13	KEYV-S06	10	1
VEH100L07.0R10I04S06		●	4	41° - 45°	10	9.7	7	1	S06	13	KEYV-S06	10	1
VEH120L09.0R10I04S06	●		4	41° - 45°	12	9.3	9	1	S06	14.3	KEYV-S06	10	2
VEH120L09.0R05I04S08		●	4	41° - 45°	12	11.7	9	0.5	S08	16.5	KEYV-S08	15	1
VEH120L09.0R10I04S08		●	4	41° - 45°	12	11.7	9	1	S08	16.5	KEYV-S08	15	1

Torque*: Recommended clamping torque (N-m)
2 pieces per package

● : Line up



VEH...

4 flute, roughing - finishing, long edge, variable helix and pitch

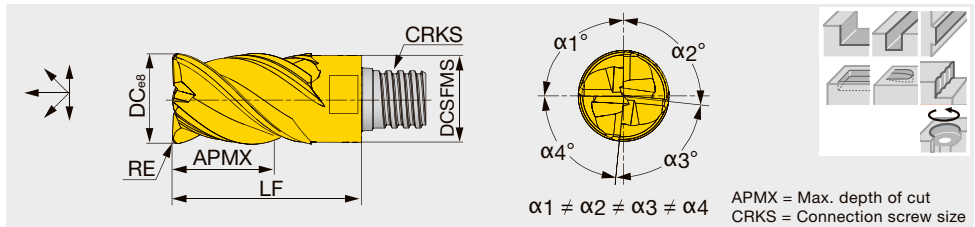

Designation	AH715	NOF	FHA	DC	DCSFMS	APMX	RE	CRKS	LF	Wrench	Torque*
VEH080L12.0R05I04S05	●	4	41° - 45°	8	7.7	12	0.5	S05	18	KEYV-S05	7
VEH080L12.0R10I04S05	●	4	41° - 45°	8	7.7	12	1	S05	18	KEYV-S05	7
VEH100L15.0R05I04S06	●	4	41° - 45°	10	9.7	15	0.5	S06	22	KEYV-S06	10
VEH100L15.0R10I04S06	●	4	41° - 45°	10	9.7	15	1	S06	22	KEYV-S06	10
VEH120L18.0R05I04S08	●	4	41° - 45°	12	11.7	18	0.5	S08	27	KEYV-S08	15
VEH120L18.0R10I04S08	●	4	41° - 45°	12	11.7	18	1	S08	27	KEYV-S08	15

Torque*: Recommended clamping torque (N-m)
VEH080 - VEH120: 2 pieces per package

● : Line up

VEE**-04..., VED**-04...

4 flute, roughing - finishing, general

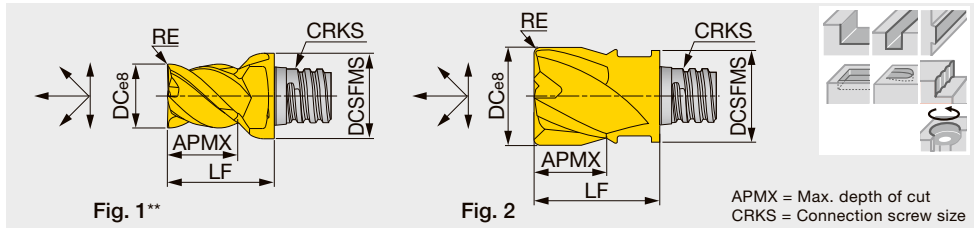

Designation	AH715	AH725	NOF	FHA	DC	DCSFMS	APMX	RE	CRKS	LF	Wrench	Torque*	Fig.
VEE050L04.0R05-04S04	●		4	45°	5	6	4	0.5	S04	8.5	KEYV-S05	4	1
VEE060L04.0R05-04S04		●	4	45°	6	5.8	4	0.5	S04	8.5	KEYV-S05	4	2
VEE060L05.0R00-04S05	●	●	4	45°	6	8	5	-	S05	10	KEYV-S05	7	1
VEE080L05.0R00-04S05		●	4	45°	8	7.7	5	-	S05	10	KEYV-S05	7	2
VED080L05.0R05-04S05		●	4	30°	8	7.7	5	0.5	S05	10	KEYV-S05	7	2
VED080L05.0R10-04S05		●	4	30°	8	7.7	5	1	S05	10	KEYV-S05	7	2
VED080L05.0R15-04S05		●	4	30°	8	7.7	5	1.5	S05	10	KEYV-S05	7	2
VEE100L07.0R00-04S06		●	4	45°	10	9.7	7	-	S06	13	KEYV-S06	10	2
VED100L07.0R05-04S06		●	4	30°	10	9.7	7	0.5	S06	13	KEYV-S06	10	2
VEE100L07.0R05-04S06		●	4	45°	10	9.7	7	0.5	S06	13	KEYV-S06	10	2
VED100L07.0R10-04S06		●	4	30°	10	9.7	7	1	S06	13	KEYV-S06	10	2
VEE100L07.0R10-04S06		●	4	45°	10	9.7	7	1	S06	13	KEYV-S06	10	2
VEE120L09.0R00-04S08	●	●	4	45°	12	11.7	9	-	S08	16.5	KEYV-S08	15	2
VED120L09.0R05-04S08		●	4	30°	12	11.7	9	0.5	S08	16.5	KEYV-S08	15	2
VEE120L09.0R05-04S08		●	4	45°	12	11.7	9	0.5	S08	16.5	KEYV-S08	15	2
VED120L09.0R10-04S08	●	●	4	30°	12	11.7	9	1	S08	16.5	KEYV-S08	15	2
VEE120L09.0R10-04S08		●	4	45°	12	11.7	9	1	S08	16.5	KEYV-S08	15	2

Torque*: Recommended clamping torque (N-m)

**Fig. 1: Avoid interference with workpiece when using this cutting head. The shank diameter is larger than the cutter diameter when assembled.
2 pieces per package

● : Line up

4 flute, roughing - finishing, variable pitch

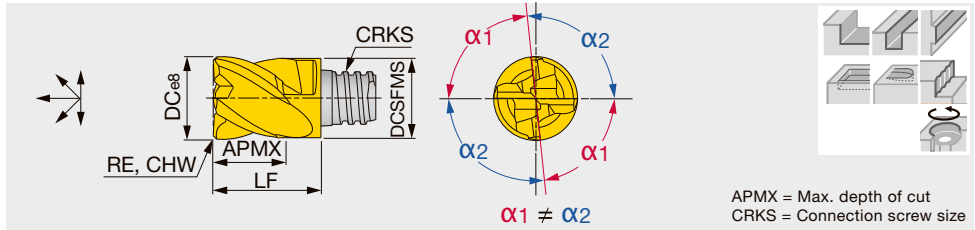

APMX = Max. depth of cut
CRKS = Connection screw size

Designation	AH715	AH725	NOF	FHA	DC	DCSFMS	APMX	RE	CHW	CRKS	LF	Wrench	Torque*
VEE080L05.0C30I04S05	●		4	38°	8	7.7	5	-	0.3	S05	10	KEYV-S05	7
VEE100L07.0C40I04S06	●		4	38°	10	9.7	7	-	0.4	S06	13	KEYV-S06	10
VEE120L09.0C50I04S08	●		4	38°	12	11.7	9	-	0.5	S08	16.5	KEYV-S08	15

Torque*: Recommended clamping torque (N-m)
VEE080 - VEE120: 2 pieces per package

● : Line up



Square

VEE**-03...

3 flute, roughing - finishing, general, for key way

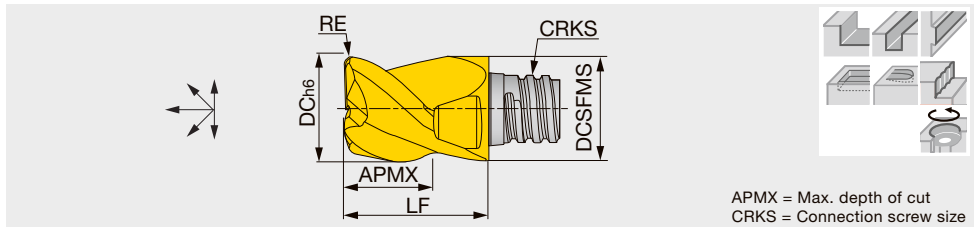

APMX = Max. depth of cut
CRKS = Connection screw size

Designation	AH715	AH725	NOF	FHA	DC	DCSFMS	APMX	RE	CRKS	LF	Wrench	Torque*
VEE077L04.0R02-03S05	●		3	38°	7.7	7.7	4	0.2	S05	10	KEYV-S05	7
VEE080L05.0R00-03S05	●		3	45°	8	7.7	5	-	S05	10	KEYV-S05	7
VEE097L05.0R03-03S06	●		3	38°	9.7	9.7	5	0.3	S06	13	KEYV-S06	10
VEE100L07.0R00-03S06	●		3	45°	10	9.7	7	-	S06	13	KEYV-S06	10
VEE117L07.0R03-03S08	●	●	3	38°	11.7	11.7	7	0.3	S08	16.5	KEYV-S08	15
VEE120L09.0R00-03S08	●		3	45°	12	11.7	9	-	S08	16.5	KEYV-S08	15

Torque*: Recommended clamping torque (N-m)
2 pieces per package

● : Line up

VEE**A02...

2 flute, roughing - finishing, for non-ferrous metal, general

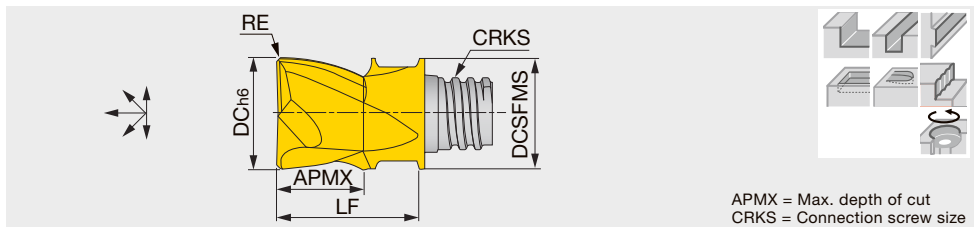

APMX = Max. depth of cut
CRKS = Connection screw size

Designation	KS15F	NOF	FHA	DC	DCSFMS	APMX	RE	CRKS	LF	Wrench	Torque*
VEE100L07.0R05A02S06	●	2	45°	10	9.7	7	0.5	S06	13	KEYV-S06	10
VEE100L07.0R10A02S06	●	2	45°	10	9.7	7	1	S06	13	KEYV-S06	10
VEE120L09.0R05A02S08	●	2	45°	12	11.7	9	0.5	S08	16.5	KEYV-S08	15

Torque*: Recommended clamping torque (N-m)
2 pieces per package

● : Line up

Reference pages: Standard cutting conditions → **8-42 - 8-43**

VEE**A03...

3 flute, roughing - finishing, for non-ferrous metal, general

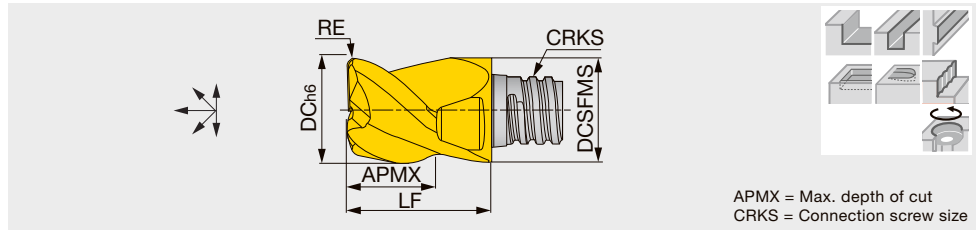

Designation	KS15F	NOF	FHA	DC	DCSFMS	APMX	RE	CRKS	LF	Wrench	Torque*
VEE080L05.0R05A03S05	●	3	45°	8	7.7	5	0.5	S05	10	KEYV-S05	7
VEE100L06.0R05A03S06	●	3	45°	10	9.7	6	0.5	S06	13	KEYV-S06	10
VEE100L06.0R10A03S06	●	3	45°	10	9.7	6	1	S06	13	KEYV-S06	10
VEE120L08.0R05A03S08	●	3	45°	12	11.7	8	0.5	S08	16.5	KEYV-S08	15
VEE120L08.0R10A03S08	●	3	45°	12	11.7	8	1	S08	16.5	KEYV-S08	15

Torque*: Recommended clamping torque (N-m)
2 pieces per package

● : Line up

VEE**C...

4 flute, roughing - semi finishing, roughing and finishing edge combination

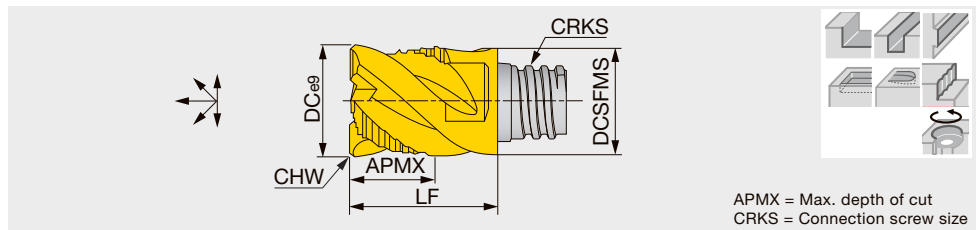

Designation	AH725	NOF	FHA	DC	DCSFMS	APMX	CHW	CRKS	LF	Wrench	Torque*
VEE080L05.0C30C04S05	●	4	45°	8	7.7	5	0.3	S05	10	KEYV-S05	7
VEE100L07.0C30C04S06	●	4	45°	10	9.7	7	0.3	S06	13	KEYV-S06	10
VEE120L09.0C40C04S08	●	4	45°	12	11.7	9	0.4	S08	16.5	KEYV-S08	15

Torque*: Recommended clamping torque (N-m)
VEE080 - VEE120: 2 pieces per package

● : Line up

STANDARD CUTTING CONDITIONS

Shoulder milling

VEH, VEE: 3 flutes, VED / VEE: 4 flutes, VEE-A, VEE-I, VEE-R, VED-R, VEE-C

ISO	Workpiece material	Hardness	Cutting speed V_c (m/min)	Feed per tooth: f_z (mm/t)					Depth of cut a_p (mm)	Width of cut a_e (mm)
				Tool diameter: DC (mm)						
				5	6	8	10	12		
P	Carbon steel S45C, S55C, etc. C45, C55, etc.	- 300 HB	80 - 180	0.03 - 0.07	0.03 - 0.07	0.05 - 0.09	0.07 - 0.12	0.08 - 0.13	0.6 x DC	0.25 x DC
	Alloy steel SCM440, SCr420, etc. 42CrMo4, 20Cr4, etc.	- 300 HB	60 - 140	0.03 - 0.07	0.03 - 0.07	0.05 - 0.09	0.07 - 0.12	0.08 - 0.13	0.6 x DC	0.25 x DC
	Prehardened steel PX5, NAK80, etc.	30 - 40 HRC	60 - 120	0.03 - 0.07	0.03 - 0.07	0.05 - 0.09	0.07 - 0.12	0.08 - 0.13	0.6 x DC	0.25 x DC
M	Stainless steel SUS304, SUS316, etc. X5CrNi18-9, X5CrNiMo17-12-2, etc.	- 200 HB	40 - 100	0.03 - 0.07	0.03 - 0.07	0.05 - 0.09	0.07 - 0.12	0.08 - 0.13	0.6 x DC	0.25 x DC
K	Grey cast iron FC250, FC300, etc. 250, 300, etc., GG250, GG300, etc.	150 - 250 HB	80 - 200	0.03 - 0.07	0.03 - 0.07	0.05 - 0.09	0.07 - 0.12	0.08 - 0.13	0.6 x DC	0.25 x DC
	Ductile cast iron FCD450, etc. 450-10S, etc., GGG450, etc.	150 - 250 HB	80 - 200	0.03 - 0.07	0.03 - 0.07	0.05 - 0.09	0.07 - 0.12	0.08 - 0.13	0.6 x DC	0.25 x DC
N	Aluminium alloys Si < 13%	-	200 - 700	0.03 - 0.07	0.03 - 0.07	0.05 - 0.09	0.07 - 0.12	0.08 - 0.13	0.6 x DC	0.25 x DC
	Aluminium alloys Si ≥ 13%	-	100 - 300	0.03 - 0.07	0.03 - 0.07	0.05 - 0.09	0.07 - 0.12	0.08 - 0.13	0.6 x DC	0.25 x DC
S	Titanium alloys Ti-6Al-4V, etc.	- 40 HRC	40 - 80	0.03 - 0.07	0.03 - 0.07	0.05 - 0.09	0.07 - 0.12	0.08 - 0.13	0.6 x DC	0.25 x DC
	Heat-resistant alloys Inconel 718, etc.	- 40 HRC	20 - 40	0.03 - 0.07	0.03 - 0.07	0.05 - 0.09	0.07 - 0.12	0.08 - 0.13	0.6 x DC	0.25 x DC
H	Hardened steel SKD61, SKT4, etc. 55NiCrMoV7, etc.	40 - 50 HRC	40 - 80	0.03 - 0.07	0.03 - 0.07	0.05 - 0.09	0.07 - 0.12	0.08 - 0.13	0.6 x DC	0.25 x DC
	Hardened steel SKD11, SKH51, etc. HS6-5-2, etc.	50 - 60 HRC	20 - 60	0.03 - 0.07	0.03 - 0.07	0.05 - 0.09	0.07 - 0.12	0.08 - 0.13	0.6 x DC	0.25 x DC



VED / VEE: 6 flutes, VED / VEE: 8, 10 flutes, VED: 7, 9 flutes

ISO	Workpiece material	Hardness	Cutting speed V_c (m/min)	Feed per tooth: f_z (mm/t)			Depth of cut a_p (mm)	Width of cut a_e (mm)
				Tool diameter: DC (mm)				
				8	10	12		
S	Titanium alloys Ti-6Al-4V, etc.	- 40 HRC	60 - 120	0.05 - 0.09	0.07 - 0.12	0.08 - 0.13	0.6 x DC	0.02 x DC
	Heat-resistant alloys Inconel 718, etc.	- 40 HRC	30 - 60	0.05 - 0.09	0.07 - 0.12	0.08 - 0.13	0.6 x DC	0.02 x DC
H	Hardened steel SKD61, SKT4, etc. 55NiCrMoV7, etc.	40 - 50 HRC	80 - 160	0.05 - 0.09	0.07 - 0.12	0.08 - 0.13	0.6 x DC	0.02 x DC
	Hardened steel SKD11, SKH51, etc. HS6-5-2, etc.	50 - 60 HRC	40 - 90	0.05 - 0.09	0.07 - 0.12	0.08 - 0.13	0.6 x DC	0.02 x DC

Slotting

VEH, VEE: 3 flutes, VED/VEE: 4 flutes, VEE-A, VEE-I, VEE-R, VEE-C

ISO	Workpiece material	Hardness	Cutting speed V_c (m/min)	Feed per tooth: f_z (mm/t)					Depth of cut a_p (mm)
				Tool diameter: DC (mm)					
				5	6	8	10	12	
P	Carbon steel S45C, S55C, etc. C45, C55, etc.	- 300 HB	50 - 70	0.03 - 0.04	0.03 - 0.04	0.03 - 0.04	0.04 - 0.05	0.05 - 0.06	0.5 x DC
	Alloy steel SCM440, SCr420, etc. 42CrMo4, 20Cr4, etc.	- 300 HB	40 - 80	0.03 - 0.04	0.03 - 0.04	0.03 - 0.04	0.04 - 0.05	0.05 - 0.06	0.5 x DC
	Prehardened steel PX5, NAK80, etc.	30 - 40 HRC	40 - 70	0.03 - 0.04	0.03 - 0.04	0.03 - 0.04	0.04 - 0.05	0.05 - 0.06	0.5 x DC
M	Stainless steel SUS304, SUS316, etc. X5CrNi18-9, X5CrNiMo17-12-2, etc.	- 200 HB	30 - 60	0.03 - 0.04	0.03 - 0.04	0.03 - 0.04	0.04 - 0.05	0.05 - 0.06	0.5 x DC
K	Grey cast iron FC250, FC300, etc. 250, 300, etc., GG250, GG300, etc.	150 - 250 HB	50 - 120	0.03 - 0.04	0.03 - 0.04	0.03 - 0.04	0.04 - 0.05	0.05 - 0.06	0.5 x DC
	Ductile cast iron FCD450, etc. 450-10S, etc., GGG450, etc.	150 - 250 HB	50 - 120	0.03 - 0.04	0.03 - 0.04	0.03 - 0.04	0.04 - 0.05	0.05 - 0.06	0.5 x DC
N	Aluminium alloys Si < 13%	-	130 - 400	0.03 - 0.04	0.03 - 0.04	0.03 - 0.04	0.04 - 0.05	0.05 - 0.06	0.5 x DC
	Aluminium alloys Si ≥ 13%	-	70 - 200	0.03 - 0.04	0.03 - 0.04	0.03 - 0.04	0.04 - 0.05	0.05 - 0.06	0.5 x DC
S	Titanium alloys Ti-6Al-4V, etc.	- 40 HRC	20 - 40	0.03 - 0.04	0.03 - 0.04	0.03 - 0.04	0.04 - 0.05	0.05 - 0.06	0.5 x DC
	Heat-resistant alloys Inconel 718, etc.	- 40 HRC	10 - 20	0.03 - 0.04	0.03 - 0.04	0.03 - 0.04	0.04 - 0.05	0.05 - 0.06	0.5 x DC
H	Hardened steel SKD61, SKT4, etc. 55NiCrMoV7, etc.	40 - 50 HRC	25 - 60	0.03 - 0.04	0.03 - 0.04	0.03 - 0.04	0.04 - 0.05	0.05 - 0.06	0.5 x DC
	Hardened steel SKD11, SKH51, etc. HS6-5-2, etc.	50 - 60 HRC	10 - 30	0.03 - 0.04	0.03 - 0.04	0.03 - 0.04	0.04 - 0.05	0.05 - 0.06	0.5 x DC

Grade

Insert

Ext. Toolholder

Int. Toolholder

Threading

Grooving

Shaper

Endmill

Drilling Tool

Technical Reference

Face mill

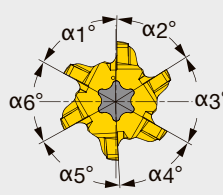
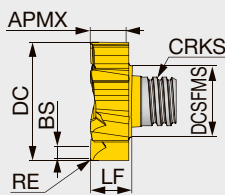

$$\alpha 1 \neq \alpha 2 \neq \alpha 3 \neq \alpha 4 \neq \alpha 5 \neq \alpha 6$$

APMX = Max. depth of cut
CRKS = Connection screw size

Designation	AH715	NOF	FHA	DC	DCSFMS	APMX	RE	BS	CRKS	LF	Wrench	Torque*
VFM120L03.6R02106S05	●	6	10°	12	7.7	3.6	0.2	1.2	S05	4.4	KEYV-T20	7
VFM160L04.8R04106S06	●	6	10°	16	9.7	4.8	0.4	2	S06	5.6	KEYV-T25	10
VFM200L06.0R04106S08	●	6	10°	20	11.7	6	0.4	2	S08	7	KEYV-T40L	15
VFM250L07.5R04106S10	●	6	10°	25	15.3	7.5	0.4	2	S10	8.55	KEYV-T50L	28

Torque*: Recommended clamping torque (N-m)
2 pieces per package

● : Line up

STANDARD CUTTING CONDITIONS

Face milling

VFM

ISO	Workpiece material	Hardness	Cutting speed Vc (m/min)	Feed per tooth: fz (mm/t)				Depth of cut ap (mm)	Width of cut ae (mm)
				Tool diameter: DC (mm)					
				12	16	20	25		
P	Carbon steel S45C, S55C, etc. C45, C55, etc.	- 300 HB	80 - 180	0.08 - 0.13	0.09 - 0.15	0.1 - 0.17	0.1 - 0.17	1	0.7 x DC
	Alloy steel SCM440, SCr420, etc. 42CrMo4, 20Cr4, etc.	- 300 HB	60 - 140	0.08 - 0.13	0.09 - 0.15	0.1 - 0.17	0.1 - 0.17	1	0.7 x DC
	Prehardened steel PX5, NAK80, etc.	30 - 40 HRC	60 - 120	0.08 - 0.13	0.09 - 0.15	0.1 - 0.17	0.1 - 0.17	1	0.7 x DC
M	Stainless steel SUS304, SUS316, etc. X5CrNi18-9, X5CrNiMo17-12-2, etc.	- 200 HB	40 - 100	0.08 - 0.13	0.09 - 0.15	0.1 - 0.17	0.1 - 0.17	1	0.7 x DC
K	Grey cast iron FC250, FC300, etc. 250, 300, etc., GG250, GG300, etc.	150 - 250 HB	80 - 200	0.08 - 0.13	0.09 - 0.15	0.1 - 0.17	0.1 - 0.17	1	0.7 x DC
	Ductile cast iron FCD450, etc. 450-10S, etc., GGG450, etc.	150 - 250 HB	80 - 200	0.08 - 0.13	0.09 - 0.15	0.1 - 0.17	0.1 - 0.17	1	0.7 x DC
N	Aluminium alloys Si < 13%	-	200 - 700	0.08 - 0.13	0.09 - 0.15	0.1 - 0.17	0.1 - 0.17	1	0.7 x DC
	Aluminium alloys Si ≥ 13%	-	100 - 300	0.08 - 0.13	0.09 - 0.15	0.1 - 0.17	0.1 - 0.17	1	0.7 x DC
S	Titanium alloys Ti-6Al-4V, etc.	- 40 HRC	40 - 80	0.08 - 0.13	0.09 - 0.15	0.1 - 0.17	0.1 - 0.17	1	0.7 x DC
	Heat-resistant alloys Inconel 718, etc.	- 40 HRC	20 - 40	0.08 - 0.13	0.09 - 0.15	0.1 - 0.17	0.1 - 0.17	1	0.7 x DC
H	Hardened steel SKD61, SKT4, etc. 55NiCrMoV7, etc.	40 - 50 HRC	40 - 80	0.08 - 0.13	0.09 - 0.15	0.1 - 0.17	0.1 - 0.17	1	0.7 x DC
	Hardened steel SKD11, SKH51, etc. HS6-5-2, etc.	50 - 60 HRC	20 - 60	0.08 - 0.13	0.09 - 0.15	0.1 - 0.17	0.1 - 0.17	1	0.7 x DC

VCA**-04/06...

4, 6 flute, chamfering angle: 45°

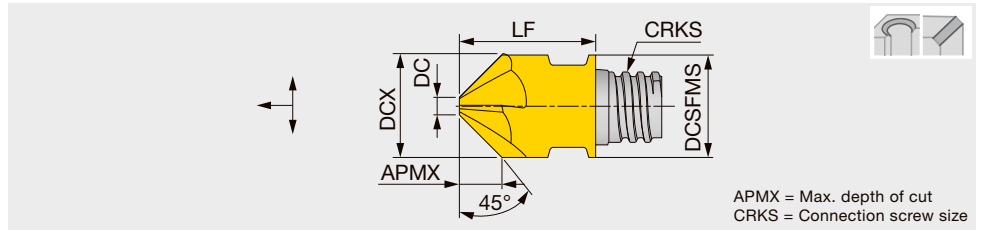

Designation	AH715	AH725	NOF	FHA	DCX	DCSFMS	APMX	DC	CRKS	LF	Wrench	Torque*
VCA100L04.0A45-04S06	●	●	4	0°	10	10	4	1.95	S06	13	KEYV-S06	10
VCA120L05.0A45-04S08	●	●	4	0°	12	12	5	1.95	S08	16.5	KEYV-S08	15
VCA127L05.3A45-04S08		●	4	0°	12.7	12.7	5.3	1.98	S08	16.5	KEYV-S08	15
VCA160L06.5A45-06S10	●	●	6	0°	16	16	6.5	3	S10	20.3	KEYV-S10	28

Torque*: Recommended clamping torque (N·m)
2 pieces per package

● : Line up

STANDARD CUTTING CONDITIONS

Chamfering and countersinking (Milling, Z-feed chamfering)

VCA

ISO	Workpiece material	Hardness	Cutting speed Vc (m/min)	Feed per tooth fz (mm/t)
P	Carbon steel S45C, S55C, etc. C45, C55, etc.	- 300 HB	60 - 100	0.03 - 0.06
	Alloy steel SCM440, SCr420, etc. 42CrMo4, 20Cr4, etc.	- 300 HB	50 - 80	0.03 - 0.06
	Prehardened steel PX5, NAK80, etc.	30 - 40 HRC	40 - 70	0.03 - 0.06
M	Stainless steel SUS304, SUS316, etc. X5CrNi18-9, X5CrNiMo17-12-2, etc.	- 200 HB	30 - 50	0.03 - 0.06
K	Grey cast iron FC250, FC300, etc. 250, 300, etc., GG250, GG300, etc.	150 - 250 HB	80 - 120	0.03 - 0.06
	Ductile cast iron FCD450, etc. 450-10S, etc., GGG450, etc.	150 - 250 HB	80 - 120	0.03 - 0.06
N	Aluminium alloys	-	100 - 200	0.04 - 0.08
S	Titanium alloys Ti-6Al-4V, etc.	- 40 HRC	30 - 50	0.025 - 0.05
	Heat-resistant alloys Inconel 718, etc.	- 40 HRC	20 - 40	0.02 - 0.04
H	Hardened steel SKD61, SKT4, etc. 55NiCrMoV7, etc.	40 - 50 HRC	30 - 50	0.025 - 0.05
	Hardened steel SKD11, SKH51, etc. HS6-5-2, etc.	50 - 60 HRC	20 - 40	0.02 - 0.04

Grade 1

Insert 2

Ext. Toolholder 3

Int. Toolholder 4

Threading 5

Grooving 6

Shaper 7

Endmill 8

Drilling Tool 9

Technical Reference 10

2 flute, chamfering angle: 30°, 45°, 60°

Chamfering
Spot drill

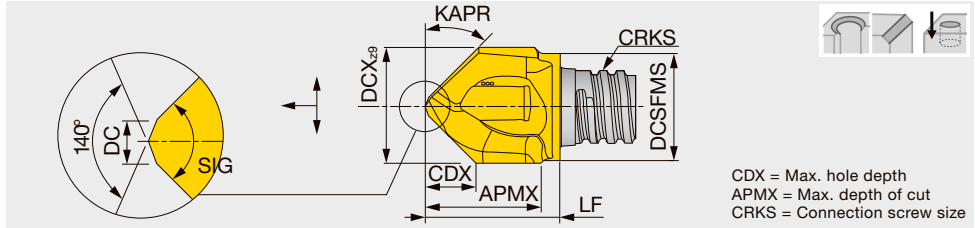

CDX = Max. hole depth
APMX = Max. depth of cut
CRKS = Connection screw size

Designation	AH715	AH725	SIG	NOF	FHA	DCX	DCSFMS	APMX	CDX	CRKS	LF	DC	KAPR	Wrench	Torque*
VCP100L09.5A30-02S06	●		60°	2	0°	10	9.5	8.5	7.5	S06	11.75	1.5	60°	KEYV-S06	10
VCP120L12.0A30-02S08	●	●	60°	2	0°	12	11.5	11	9.2	S08	15.4	1.5	60°	KEYV-S08	15
VCP160L15.0A30-02S10	●	●	60°	2	0°	16	15.2	16	12	S10	20.2	2.5	60°	KEYV-S10	28
VCP080L07.7A45-02S05	●	●	90°	2	0°	8	7.6	7.5	3.7	S05	9.75	1	45°	KEYV-S05	7
VCP083L07.9A45-02S05	●	●	90°	2	0°	8.3	7.6	7.5	3.8	S05	10	1	45°	KEYV-S05	7
VCP100L09.0A45-02S06	●	●	90°	2	0°	10	9.5	9.5	4.4	S06	11.75	1.5	45°	KEYV-S06	10
VCP104L09.0A45-02S06	●	●	90°	2	0°	10.4	9.5	9.5	4.6	S06	11.75	1.5	45°	KEYV-S06	10
VCP120L12.0A45-02S08	●	●	90°	2	0°	12	11.5	11.5	5.4	S08	15.4	1.5	45°	KEYV-S08	15
VCP124L12.0A45-02S08	●	●	90°	2	0°	12.4	11.5	11.5	5.6	S08	15.4	1.5	45°	KEYV-S08	15
VCP160L15.0A45-02S10	●	●	90°	2	0°	16	15.2	15	7.1	S10	18.8	1.5	45°	KEYV-S10	28
VCP165L15.0A45-02S10	●	●	90°	2	0°	16.5	15.2	15	7.1	S10	18.8	1.5	45°	KEYV-S10	28
VCP100L09.5A60-02S06	●	●	120°	2	0°	10	9.5	9.5	2.7	S06	12.7	1.5	30°	KEYV-S06	10
VCP120L12.0A60-02S08	●	●	120°	2	0°	12	11.5	11.5	3.3	S08	15.2	1.5	30°	KEYV-S08	15
VCP160L15.5A60-02S10	●	●	120°	2	0°	16	15.2	16	4.4	S10	19.9	1.5	30°	KEYV-S10	28

Torque*: Recommended clamping torque (N-m)
2 pieces per package

● : Line up

- Square
- Chamfering
- Slotting
- Threading
- Others

2

VDS...

2 flute, chamfering angle: 45°, helix cutting edge

Chamfering
Spot drill

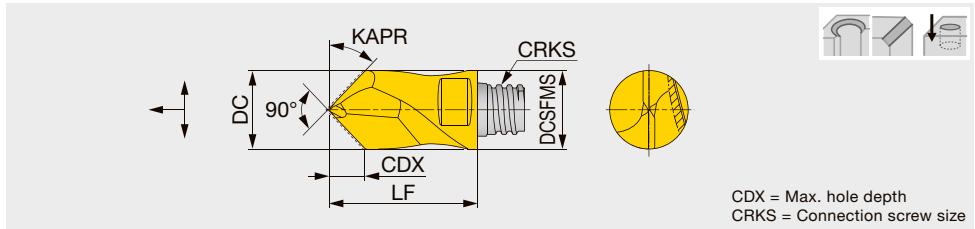

CDX = Max. hole depth
CRKS = Connection screw size

Designation	AH725	NOF	FHA	DC	DCSFMS	CDX	KAPR	CRKS	LF	Wrench	Torque*
VDS080A45-02S05	●	2	10°	8	7.7	3.7	45°	S05	15	KEYV-S05	7
VDS100A45-02S06	●	2	10°	10	9.7	4.4	45°	S06	19	KEYV-S06	10
VDS120A45-02S08	●	2	10°	12	11.7	5.4	45°	S08	23	KEYV-S08	15
VDS160A45-02S10	●	2	10°	16	15.3	7.1	45°	S10	28	KEYV-S10	28

Torque*: Recommended clamping torque (N-m)
2 pieces per package

● : Line up

STANDARD CUTTING CONDITIONS

Spot drill
VCP, VDS

ISO	Workpiece material	Hardness	Cutting speed Vc (m/min)	Feed f (mm/rev)
P	Carbon steel S45C, S55C, etc. C45, C55, etc.	- 300 HB	60 - 100	0.06 - 0.12
	Alloy steel SCM440, SCr420, etc. 42CrMo4, 20Cr4, etc.	- 300 HB	50 - 80	0.06 - 0.12
	Prehardened steel PX5, NAK80, etc.	30 - 40 HRC	40 - 70	0.06 - 0.12
M	Stainless steel SUS304, SUS316, etc. X5CrNi18-9, X5CrNiMo17-12-2, etc.	- 200 HB	30 - 50	0.06 - 0.12
K	Grey cast iron FC250, FC300, etc. 250, 300, etc., GG250, GG300, etc.	150 - 250 HB	80 - 120	0.06 - 0.12
	Ductile cast iron FCD450, etc. 450-10S, etc., GGG450, etc.	150 - 250 HB	80 - 120	0.06 - 0.12
N	Aluminium alloys	-	100 - 200	0.08 - 0.16
S	Titanium alloys Ti-6Al-4V, etc.	- 40 HRC	30 - 50	0.05 - 0.1
	Heat-resistant alloys Inconel 718, etc.	- 40 HRC	20 - 40	0.04 - 0.08
H	Hardened steel SKD61, SKT4, etc. 55NiCrMoV7, etc.	40 - 50 HRC	30 - 50	0.05 - 0.1
	Hardened steel SKD11, SKH51, etc. HS6-5-2, etc.	50 - 60 HRC	20 - 40	0.04 - 0.08

Grade

1

Insert

2

Toolholder

3

Ext. Toolholder

3

Toolholder

4

Int. Toolholder

4

Threading

5

Grooving

6

Shaper

7

Endmill

8

Drilling Tool

9

Technical Reference

10

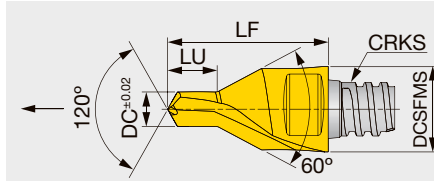

Fig. 1 Type A

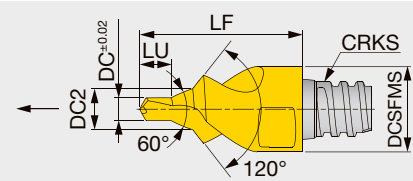

Fig. 2 Type B

CRKS = Connection screw size

Designation	AH725	NOF	FHA	DC±0.02	DC2	DCSFMS	LU	CRKS	LF	Wrench	Torque*	Fig.
VDP107L1.60A30-02S04	●	2	0°	1.07	-	6	1.6	S04	10	KEYV-S05	4	1
VDP165L2.40A30-02S04	●	2	0°	1.65	-	6	2.4	S04	10	KEYV-S05	4	1
VDP207L2.90A30-02S04	●	2	0°	2.07	-	6	2.9	S04	10	KEYV-S05	4	1
VDP328L04.6A30-02S05	●	2	0°	3.28	-	8	4.6	S05	15	KEYV-S05	7	1
VDP412L05.9A30-02S06	●	2	0°	4.12	-	10	5.9	S06	19	KEYV-S06	10	1
VDP513L07.2A30-02S08	●	2	0°	5.13	-	12	7.2	S08	23	KEYV-S08	15	1
VDP646L08.9A30-02S10	●	2	0°	6.46	-	16	8.9	S10	28	KEYV-S10	28	1
VDP324L4.38B30-02S08	●	2	0°	3.24	6.77	12	4.4	S08	23	KEYV-S08	15	2
VDP409L5.60B30-02S08	●	2	0°	4.09	8.56	12.7	5.6	S08	23	KEYV-S08	15	2

Torque*: Recommended clamping torque (N·m)
2 pieces per package

● : Line up

- Square
- Chamfering
- Slotting
- Threading
- Others

STANDARD CUTTING CONDITIONS

Center drill

VDP

ISO	Workpiece material	Hardness	Cutting speed Vc (m/min)	Feed : f (mm/rev)				
				VDP107	VDP165	VDP2	VDP3	VDP4
P	Carbon steel S45C, S55C, etc. C45, C55, etc.	- 300 HB	40 - 80	0.02 - 0.04	0.025 - 0.05	0.025 - 0.05	0.04 - 0.08	0.05 - 0.1
	Alloy steel SCM440, SCr420, etc. 42CrMo4, 20Cr4, etc.	- 300 HB	30 - 50	0.02 - 0.04	0.025 - 0.05	0.025 - 0.05	0.04 - 0.08	0.05 - 0.1
	Prehardened steel PX5, NAK80, etc.	30 - 40 HRC	20 - 30	0.02 - 0.04	0.025 - 0.05	0.025 - 0.05	0.04 - 0.08	0.05 - 0.1
M	Stainless steel SUS304, SUS316, etc. X5CrNi18-9, X5CrNiMo17-12-2, etc.	- 200 HB	15 - 25	0.015 - 0.03	0.02 - 0.04	0.02 - 0.04	0.04 - 0.08	0.05 - 0.1
K	Grey cast iron FC250, FC300, etc. 250, 300, etc., GG250, GG300, etc.	150 - 250 HB	60 - 100	0.02 - 0.04	0.025 - 0.05	0.025 - 0.05	0.05 - 0.09	0.07 - 0.012
	Ductile cast iron FCD450, etc. 450-10S, etc., GGG450, etc.	150 - 250 HB	60 - 100	0.02 - 0.04	0.025 - 0.05	0.025 - 0.05	0.04 - 0.08	0.05 - 0.1
S	Titanium alloys Ti-6Al-4V, etc.	- 40 HRC	15 - 25	0.01 - 0.02	0.01 - 0.02	0.015 - 0.03	0.04 - 0.07	0.04 - 0.07
	Heat-resistant alloys Inconel 718, etc.	- 40 HRC	10 - 20	0.01 - 0.02	0.01 - 0.02	0.015 - 0.03	0.03 - 0.06	0.03 - 0.06
H	Hardened steel SKD61, SKT4, etc. 55NiCrMoV7, etc.	40 - 50 HRC	15 - 25	-	-	-	0.04 - 0.07	0.04 - 0.07
	Hardened steel SKD11, SKH51, etc. HS6-5-2, etc.	50 - 60 HRC	10 - 20	-	-	-	0.03 - 0.06	0.03 - 0.06

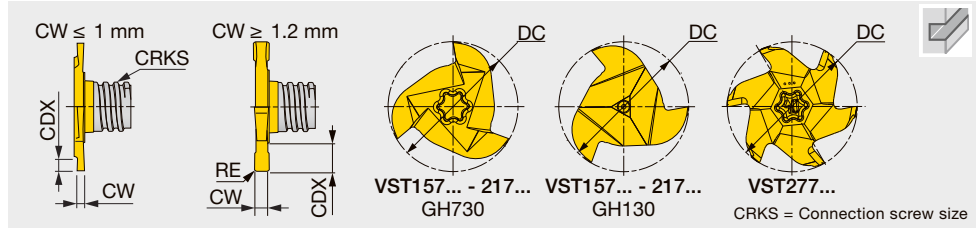
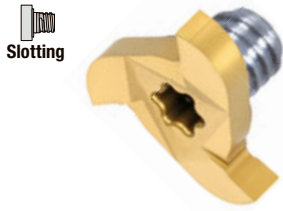

Designation	GH730	AH735	NOF	FHA	DC	CW±0.02	RE	CRKS	CDX	Wrench	Torque*
VST157W1.50R010-3S06	●		3	0°	15.7	1.5	0.1	S06	2.8	KEYV-177 ⁽²⁾ / KEYV-T20	10
VST157W1.57R020-3S06	●		3	0°	15.7	1.57	0.2	S06	2.8	KEYV-177 ⁽²⁾ / KEYV-T20	10
VST157W2.00R020-3S06	●		3	0°	15.7	2	0.2	S06	2.8	KEYV-177 ⁽²⁾ / KEYV-T20	10
VST157W2.39R020-3S06	●		3	0°	15.7	2.39	0.2	S06	2.8	KEYV-177 ⁽²⁾ / KEYV-T20	10
VST157W2.50R020-3S06	●		3	0°	15.7	2.5	0.2	S06	2.8	KEYV-177 ⁽²⁾ / KEYV-T20	10
VST157W3.00R020-3S06	●		3	0°	15.7	3	0.2	S06	2.8	KEYV-177 ⁽²⁾ / KEYV-T25	10
VST157W3.17R020-3S06			3	0°	15.7	3.17	0.2	S06	2.8	KEYV-177	10
VST177W1.20R005-3S06	●		3	0°	17.7	1.2 ⁽¹⁾	0.05	S06	3.8	KEYV-177 ⁽²⁾ / KEYV-T20	10
VST177W1.40R005-3S06	●		3	0°	17.7	1.4 ⁽¹⁾	0.05	S06	3.8	KEYV-177 ⁽²⁾ / KEYV-T20	10
VST177W1.50R010-3S06	●		3	0°	17.7	1.5	0.1	S06	3.8	KEYV-177 ⁽²⁾ / KEYV-T20	10
VST177W1.57R020-3S06	●		3	0°	17.7	1.57	0.2	S06	3.8	KEYV-177 ⁽²⁾ / KEYV-T20	10
VST177W1.70R005-3S06	●		3	0°	17.7	1.7 ⁽¹⁾	0.05	S06	3.8	KEYV-177 ⁽²⁾ / KEYV-T20	10
VST177W2.00R020-3S06	●		3	0°	17.7	2	0.2	S06	3.8	KEYV-177 ⁽²⁾ / KEYV-T20	10
VST177W2.20R110-3S06			3	0°	17.7	2.20	1.1	S06	3.8	KEYV-177	10
VST177W2.39R020-3S06			3	0°	17.7	2.39	0.2	S06	3.8	KEYV-177	10
VST177W2.50R020-3S06	●		3	0°	17.7	2.5	0.2	S06	3.8	KEYV-177 ⁽²⁾ / KEYV-T20	10
VST177W3.00R020-3S06	●	▲	3	0°	17.7	3	0.2	S06	3.8	KEYV-177 ⁽²⁾ / KEYV-T25	10
VST177W3.17R020-3S06			3	0°	17.7	3.17	0.2	S06	3.8	KEYV-177	10

(1) CW is based on DIN471 / 472

(2) Applicable for AH735

Torque*: Recommended clamping torque (N·m)

2 pieces per package

● : Line up

▲ : To be discontinued

VST**-4/6...

4, 6 flute, for slotting

Slotting

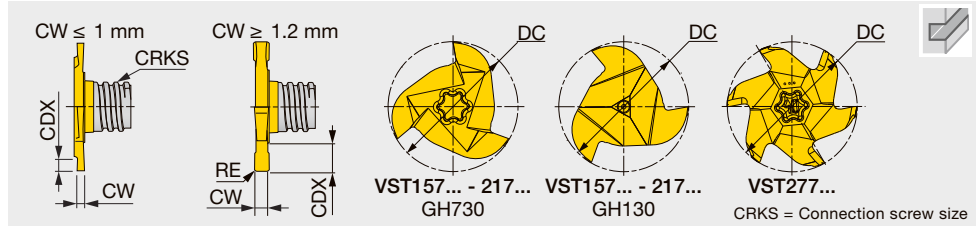

Designation	GH730	AH735	NOF	FHA	DC	CW±0.02	RE	CRKS	CDX	Wrench	Torque*
VST217W0.76R000-4S08	●		4	0°	21.7	0.76 ⁽¹⁾	-	S08	1.5	KEYV-217 ⁽²⁾ / KEYV-T25	15
VST217W0.86R000-4S08			4	0°	21.7	0.86 ⁽¹⁾	-	S08	1.7	KEYV-217	15
VST217W0.96R000-4S08	●		4	0°	21.7	0.96 ⁽¹⁾	-	S08	1.9	KEYV-217 ⁽²⁾ / KEYV-T25	15
VST217W1.00R005-4S08	●		4	0°	21.7	1	0.05	S08	2	KEYV-217 ⁽²⁾ / KEYV-T25	15
VST217W1.20R005-4S08	●		4	0°	21.7	1.2 ⁽¹⁾	0.05	S08	4.5	KEYV-217 ⁽²⁾ / KEYV-T25	15
VST217W1.40R005-4S08	●		4	0°	21.7	1.4 ⁽¹⁾	0.05	S08	4.5	KEYV-217 ⁽²⁾ / KEYV-T25	15
VST217W1.57R000-4S08	●		4	0°	21.7	1.57	-	S08	4.5	KEYV-217 ⁽²⁾ / KEYV-T25	15
VST217W1.70R010-4S08	●		4	0°	21.7	1.7 ⁽¹⁾	0.1	S08	4.5	KEYV-217 ⁽²⁾ / KEYV-T25	15
VST217W1.95R020-4S08	●		4	0°	21.7	1.95 ⁽¹⁾	0.2	S08	4.5	KEYV-217 ⁽²⁾ / KEYV-T25	15
VST217W2.00R020-4S08	●		4	0°	21.7	2	0.2	S08	4.5	KEYV-217 ⁽²⁾ / KEYV-T25	15
VST217W2.25R020-4S08	●		4	0°	21.7	2.25 ⁽¹⁾	0.2	S08	4.5	KEYV-217 ⁽²⁾ / KEYV-T25	15
VST217W2.39R020-4S08	●		4	0°	21.7	2.39	0.2	S08	4.5	KEYV-217 ⁽²⁾ / KEYV-T25	15
VST217W2.50R020-4S08	●	▲	4	0°	21.7	2.5	0.2	S08	4.5	KEYV-217 ⁽²⁾ / KEYV-T25	15
VST217W2.75R020-4S08	●		4	0°	21.7	2.75 ⁽¹⁾	0.2	S08	4.5	KEYV-217 ⁽²⁾ / KEYV-T25	15
VST217W3.00R020-4S08	●	▲	4	0°	21.7	3	0.2	S08	4.5	KEYV-217 ⁽²⁾ / KEYV-T30L	15
VST217W3.17R020-4S08	●		4	0°	21.7	3.17	0.2	S08	4.5	KEYV-217 ⁽²⁾ / KEYV-T30L	15
VST217W3.25R020-4S08	●		4	0°	21.7	3.25 ⁽¹⁾	0.2	S08	4.5	KEYV-217 ⁽²⁾ / KEYV-T30L	15
VST217W4.00R020-4S08	●		4	0°	21.7	4	0.2	S08	4.5	KEYV-217 ⁽²⁾ / KEYV-T30L	15
VST217W4.25R020-4S08	●		4	0°	21.7	4.25 ⁽¹⁾	0.2	S08	4.5	KEYV-217 ⁽²⁾ / KEYV-T30L	15
VST217W4.75R020-4S08	●		4	0°	21.7	4.75	0.2	S08	4.5	KEYV-217 ⁽²⁾ / KEYV-T30L	15
VST217W5.25R020-4S08	●		4	0°	21.7	5.25 ⁽¹⁾	0.2	S08	4.5	KEYV-217 ⁽²⁾ / KEYV-T30L	15
VST277W2.50R020-6S10	●		6	0°	27.7	2.5	0.2	S10	6	KEYV-T40L	28
VST277W5.25R020-6S10	●		6	0°	27.7	5.25 ⁽¹⁾	0.2	S10	6	KEYV-T40L	28
VST277W10.0R020-6S10	●		6	0°	27.7	10	0.2	S10	6	KEYV-T40L	28

(1) CW is based on DIN471 / 472

(2) Applicable for AH735

Torque*: Recommended clamping torque (N-m)

2 pieces per package

● : Line up

▲ : To be discontinued

2

3

4

5

6 or more

VST**A45...

3, 4 flute, for slotting with 45° chamfer

Slotting

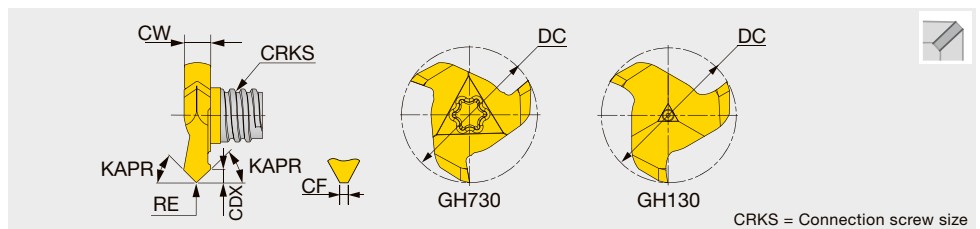

Designation	GH730	GH130	NOF	FHA	DC	CW	KAPR	CRKS	CDX	CF	RE	Wrench	Torque*
VST177L01.40A45-3S06	●	▲	3	0°	17.7	3.4	45°	S06	1.4	-	0.1	KEYV-177 ⁽¹⁾ / KEYV-T25 ⁽²⁾	10
VST217L01.70A45-4S08	●	▲	4	0°	21.7	5.5	45°	S08	1.7	1.5	-	KEYV-217 ⁽¹⁾ / KEYV-T30L ⁽²⁾	15

(1) Applicable for GH130

(2) Applicable for GH730

Torque*: Recommended clamping torque (N-m)

2 pieces per package

● : Line up

▲ : To be discontinued

STANDARD CUTTING CONDITIONS

Slotting

VST

ISO	Workpiece material	Hardness	VST	
			Cutting speed Vc (m/min)	Feed per tooth fz (mm/t)
P	Carbon steel S45C, S55C, etc. C45, C55, etc.	- 300 HB	80 - 180	0.05 - 0.15
	Alloy steel SCM440, SCr420, etc. 42CrMo4, 20Cr4, etc.	- 300 HB	60 - 120	0.04 - 0.12
M	Stainless steel SUS304, SUS316, etc. X5CrNi18-9, X5CrNiMo17-12-2, etc.	- 200 HB	50 - 120	0.04 - 0.12
K	Grey cast iron FC250, FC300, etc. 250, 300, etc., GG250, GG300, etc.	150 - 250 HB	100 - 200	0.05 - 0.15
	Ductile cast iron FCD450, etc. 450-10S, etc., GGG450, etc.	150 - 250 HB	100 - 200	0.04 - 0.12
N	Aluminium alloys Si < 13%	-	200 - 600	0.05 - 0.15
	Aluminium alloys Si ≥ 13%	-	100 - 300	0.03 - 0.13
S	Titanium alloys Ti-6Al-4V, etc.	- 40 HRC	40 - 60	0.04 - 0.12
	Heat-resistant alloys Inconel 718, etc.	- 40 HRC	15 - 35	0.02 - 0.1

Tolerance of tool diameter

Basic dimensions (mm)		Permissible dimensional deviations (μm)						
>	≤	e8	e9	h6	h7	h9	h10	z9
6	10	-25 -47	-25 -61	0 -9	0 -15	0 -36	0 -58	+78 +42
10	14	-32 -59	-32 -75	0 -11	0 -18	0 -43	0 -70	+93 +50
14	18	-32 -59	-32 -75	0 -11	0 -18	0 -43	0 -70	+103 +60
18	30	-40 -73	-40 -92	0 -13	0 -21	0 -52	0 -84	-

JISB0401-2: 1998 (ISO286-2: 1988) extract

Grade
1
Insert
2
Ext. Toolholder
3
Int. Toolholder
4
Threading
5
Grooving
6
Shaper
7
Endmill
8
Drilling Tool
9
Technical Reference
10

Straight neck with ER11/16 collet

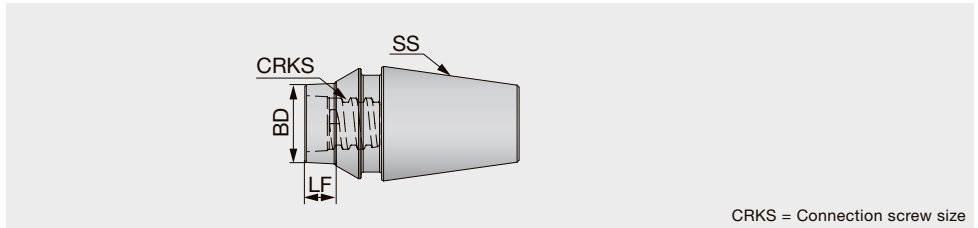

CRKS = Connection screw size

Designation	SS	BD	LF	CRKS	Shank material
VER11AL006S04-S	ER11	5.8	6	S04	Steel
VER11AL006S05-S	ER11	7.9	6	S05	Steel
VER11AL020S05-S	ER11	7.9	20	S05	Steel
VER16AL012S05-S	ER16	7.9	12	S05	Steel
VER16AL020S05-S	ER16	7.9	20	S05	Steel
VER16AL010S06-S	ER16	9.9	10	S06	Steel
VER16AL020S06-S	ER16	9.9	20	S06	Steel
VER16AL006S08-S	ER16	11.6	6	S08	Steel
VER16AL020S08-S	ER16	11.6	20	S08	Steel

- Square
- ◊ Chamfering
- ▨ Slotting
- ▨ Threading
- Others

VSSD**-W-A...

Straight shank and neck with coolant hole

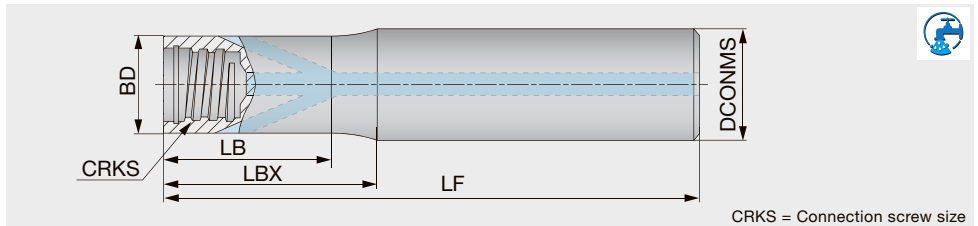

CRKS = Connection screw size

Designation	DCONMS	BD	LF	LBX	LB	CRKS	Shank material
VSSD10L070S06-W-A	10	9.6	70	20	19	S06	Tungsten
VSSD10L090S06-W-A	10	9.6	90	40	39	S06	Tungsten
VSSD10L110S06-W-A	10	9.6	110	60	59	S06	Tungsten
VSSD12L070S08-W-A	12	11.5	70	20	19	S08	Tungsten
VSSD12L090S08-W-A	12	11.5	90	40	39	S08	Tungsten
VSSD12L110S08-W-A	12	11.5	110	60	59	S08	Tungsten
VSSD12L130S08-W-A	12	11.5	130	80	79	S08	Tungsten
VSSD16L070S10-W-A	16	15.2	70	20	18.5	S10	Tungsten
VSSD16L090S10-W-A	16	15.2	90	40	36.5	S10	Tungsten
VSSD16L110S10-W-A	16	15.2	110	60	58.5	S10	Tungsten
VSSD16L130S10-W-A	16	15.2	130	80	78.5	S10	Tungsten

VSSD...

High rigidity shank

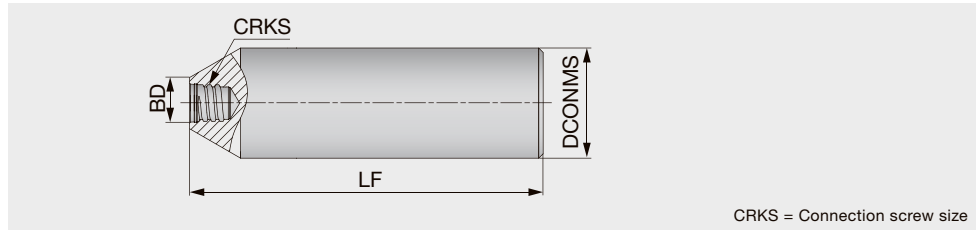

CRKS = Connection screw size

Designation	DCONMS	BD	LF	CRKS	Shank shape	Shank material
VSSD06L050S04-S	6	5.8	50	S04	Cylindrical	Steel
VSSD06L060S04-C	6	5.8	60	S04	Cylindrical	Carbide
VSSD08L050S04-S	8	5.8	50	S04	Cylindrical	Steel
VSSD08L060S04-C	8	5.8	60	S04	Cylindrical	Carbide
VSSD10L055S05-S	10	7.6	55	S05	Cylindrical	Steel
VSSD12L065S06-S	12	9.6	65	S06	Cylindrical	Steel
VSSD16L065S08-S	16	11.6	65	S08	Cylindrical	Steel
VSSD20L070S10-S	20	15.3	70	S10	Cylindrical	Steel

VSSD...

Straight neck and cylindrical shank

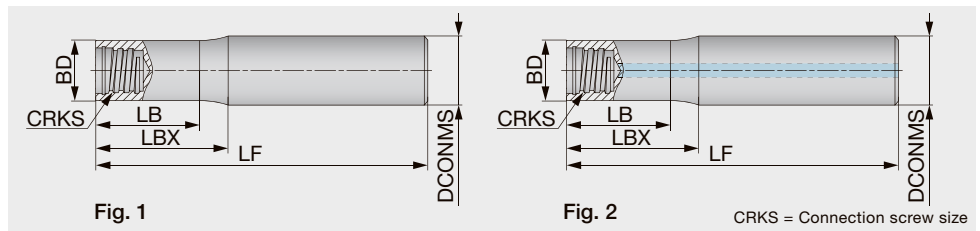
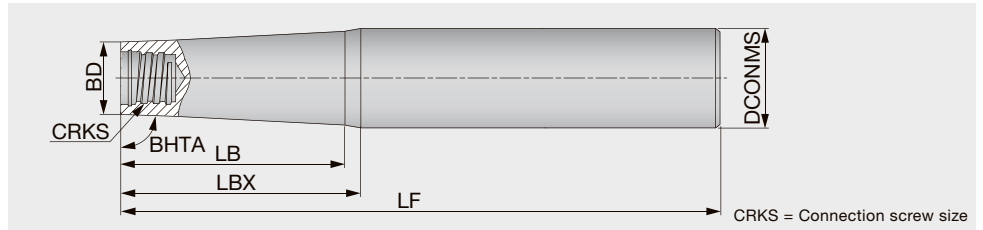

Fig. 1

Fig. 2

CRKS = Connection screw size

Designation	DCONMS	BD	LF	LBX	LB	CRKS	Shank shape	Shank material	Fig.
VSSD08L060S05-S	8	7.6	60	15	12.8	S05	Cylindrical	Steel	1
VSSD08L070S05-C	8	7.6	70	20	19	S05	Cylindrical	Carbide	1
VSSD08L090S05-C	8	7.6	90	40	39	S05	Cylindrical	Carbide	1
VSSD08L110S05-C	8	7.6	110	60	59	S05	Cylindrical	Carbide	1
VSSD10L070S06-C	10	9.6	70	20	18.5	S06	Cylindrical	Carbide	1
VSSD10L075S06-S	10	9.6	75	20	19.4	S06	Cylindrical	Steel	1
VSSD10L090S06-C	10	9.6	90	40	38.5	S06	Cylindrical	Carbide	1
VSSD10L110S06-C	10	9.6	110	60	58.5	S06	Cylindrical	Carbide	1
VSSD10L150S06-C	10	9.6	150	100	98.5	S06	Cylindrical	Carbide	1
VSSD12L070S08-C	12	11.5	70	20	17	S08	Cylindrical	Carbide	1
VSSD12L070S08-C-A	12	11.5	70	20	17	S08	Cylindrical	Carbide	2
VSSD12L090S08-C	12	11.5	90	40	37	S08	Cylindrical	Carbide	1
VSSD12L090S08-S	12	11.5	90	16	13.6	S08	Cylindrical	Steel	1
VSSD12L090S08-S-A	12	11.5	90	16	13.6	S08	Cylindrical	Steel	2
VSSD12L090LS08-C-A	12	11.5	90	40	37	S08	Cylindrical	Carbide	2
VSSD12L090LS08-S-A	12	11.5	90	42	37	S08	Cylindrical	Steel	2
VSSD12L110S08-C	12	11.5	110	60	58	S08	Cylindrical	Carbide	1
VSSD12L110S08-C-A	12	11.5	110	60	57	S08	Cylindrical	Carbide	2
VSSD12L130S08-C	12	11.5	130	80	78	S08	Cylindrical	Carbide	1
VSSD12L130S08-C-A	12	11.5	130	80	77	S08	Cylindrical	Carbide	2
VSSD16L090S10-C	16	15.2	90	40	38	S10	Cylindrical	Carbide	1
VSSD16L090S10-C-A	16	15.2	90	40	38	S10	Cylindrical	Carbide	2
VSSD16L100S10-S	16	15.2	100	20	18	S10	Cylindrical	Steel	1
VSSD16L100S10-S-A	16	15.2	100	20	18	S10	Cylindrical	Steel	2
VSSD16L100LS10-S-A	16	15.2	100	42	38	S10	Cylindrical	Steel	2
VSSD16L110S10-C	16	15.2	110	60	58	S10	Cylindrical	Carbide	1
VSSD16L110S10-C-A	16	15.2	110	60	58	S10	Cylindrical	Carbide	2
VSSD16L130S10-C	16	15.2	130	80	78	S10	Cylindrical	Carbide	1
VSSD16L130S10-C-A	16	15.2	130	80	78	S10	Cylindrical	Carbide	2
VSSD16L150S10-C	16	15.2	150	100	98	S10	Cylindrical	Carbide	1



Designation	BHTA	DCONMS	BD	LF	LBX	LB	CRKS	Shank material
VTSD08L080S04-S	87.4°	8	5.8	80	24	-	S04	Steel
VTSD12L080S05-S	85°	12	7.6	80	25	-	S05	Steel
VTSD12L100S05-S	89°	12	7.6	100	35	29	S05	Steel
VTSD12L110S05-C	89°	12	7.6	110	60	56	S05	Carbide
VTSD12L130S05-C	89°	12	7.6	130	80	77	S05	Carbide
VTSD16L125S06-S	85°	16	9.6	125	34	31	S06	Steel
VTSD16L130S08-C	89°	16	11.5	130	80	76.5	S08	Carbide
VTSD16L140S08-S	85°	16	11.5	140	22	19	S08	Steel
VTSD16L150S05-C	89°	16	7.6	150	100	91	S05	Carbide
VTSD16L150S06-C	89°	16	9.6	150	100	94.5	S06	Carbide
VTSD16L150S08-C	89°	16	11.5	150	100	98	S08	Carbide
VTSD16L160S06-S	89°	16	9.6	160	55	46.5	S06	Steel
VTSD16L170S06-C	89°	16	9.6	170	120	116.5	S06	Carbide
VTSD20L140S10-S	85°	20	15.2	140	27.5	-	S10	Steel
VTSD20L170S08-C	89°	20	11.5	170	120	112	S08	Carbide
VTSD20L170S08-S	89°	20	11.5	170	80	69.5	S08	Steel
VTSD20L170S10-C	89°	20	15.2	170	120	119	S10	Carbide
VTSD20L190S10-C	89°	20	15.2	190	140	-	S10	Carbide
VTSD20L190S10-S	89°	20	15.2	190	80	73	S10	Steel
VTSD20L210S10-C	89°	20	15.2	210	160	-	S10	Carbide
VTSD25L160S12-S	85°	25	18.3	160	40	-	S12	Steel
VTSD25L170S10-S	85°	25	15.2	170	56	-	S10	Steel

Square

Chamfering

Slotting

Threading

Others

VTSD**-W-A...

Straight shank and taper neck with coolant hole

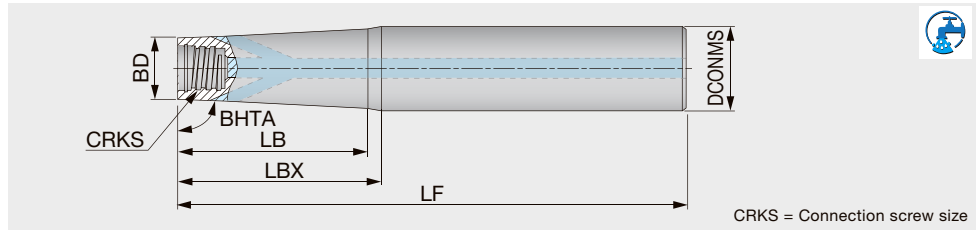

CRKS = Connection screw size

Designation	BHTA	DCONMS	BD	LF	LBX	LB	CRKS	Shank material
VTSD12L110S06-W-A	89°	12	9.6	110	60	59	S06	Tungsten
VTSD16L170S06-W-A	89°	16	9.6	170	120	116	S06	Tungsten

VSC...

Straight shank for VST type slotting heads

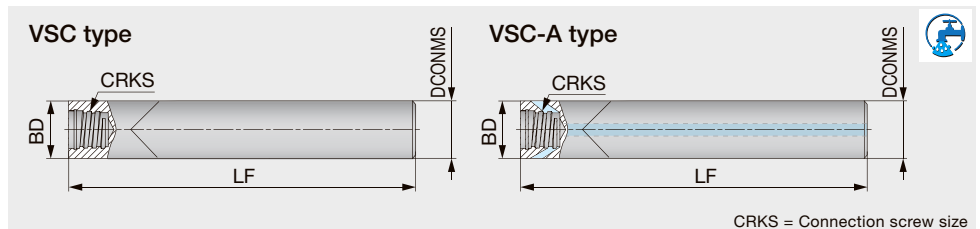

CRKS = Connection screw size

Designation	DCONMS	BD	LF	CRKS	Air hole	Shank material
VSC100L100S06-C	10	10	100	S06	without	Carbide
VSC120L100S08-C-A	12	12	100	S08	with	Carbide

For VSC-C type shank, just VST slotting head is recommended.

If other heads are used on the VSC-C shank, the depth of cut must be smaller than the max. ap in each head.

The VSC-C type shank does not have external clearance, so the shank may interfere with the work piece.

VSTD...

Straight shank for VTB type T-slotting heads

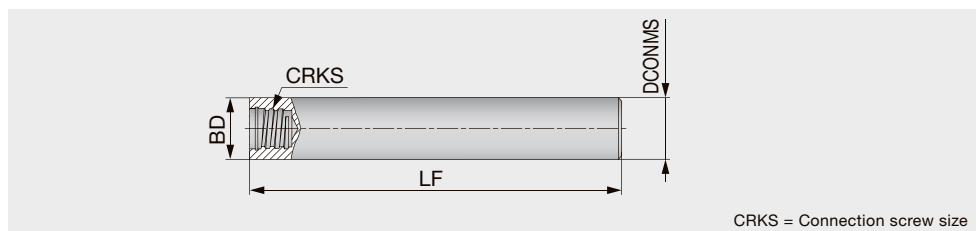

CRKS = Connection screw size

Designation	DCONMS	BD	LF	CRKS	Shank material
VSTD06L070S04-S	6	6	70	S04	Steel
VSTD08L070S05-S	8	8	70	S05	Steel
VSTD10L080S06-S	10	10	80	S06	Steel
VSTD12L090S08-S	12	12	90	S08	Steel
VSTD16L100S10-S	16	16	100	S10	Steel

For VSTD type shank, just VTB T-slotting head is recommended.





If other heads are used on the VSTD shank, the depth of cut must be smaller than the max. ap in each head.

The VSTD type shank does not have external clearance, so the shank may interfere with the work piece.

Grade
Insert
Ext. Toolholder
Int. Toolholder
Threading
Grooving
Shaper
Endmill
Drilling Tool
Technical Reference

1
2
3
4
5
6
7
8
9
10





WRENCH

Appearance	Designation	Connection screw size	Torque (N·m)	Applicable head
	KEYV-S05	S04	4	Square Ball Radius Drilling Chamfering Counterboring Barrel Lens Bull nose Indexable modular head
		S05	7	
	KEYV-S06	S06	10	
	KEYV-S08	S08	15	
	KEYV-S10	S10	28	
	KEYV-S12	S12	28	
	KEYV-W20	S15	40	
	KS-24	S21	110	Square
	KEYV-177	S06	10	Slotting VST Threading VTR
	KEYV-217	S08	15	
	KEYV-T20	S05	7	Slotting VTB Face mill
		S06	10	
	KEYV-T25	S06	10	
	KEYV-T30L	S08	15	Slotting VST, VTB Face mill
	KEYV-T40L	S08	15	
		S10	28	
	KEYV-T50L	S08	15	Slotting VTB Face mill
		S10	28	

-  Square
-  Chamfering
-  Slotting
-  Threading
-  Others

Note: Wrenches are sold separately.

TORQUE WRENCHES

Appearance		Designation	Stock	Connection screw size	TM Head description	Torque (N-m)
Handle		TORQUEWRENCH5-50NM9x12	●	-	-	5 - 50
Open wrenches for cylindrical heads		TM-WRENCH-6-05	●	S05	VEH, VED, VEE, VEE-I, VEE-R, VEE-C, VEE-A,	7
		TM-WRENCH-8-06	●	S06	VFX**-04/06, VRD,	10
		TM-WRENCH-10-08	●	S08	VBD-BG, VBE-BG,	15
		TM-WRENCH-13-10	●	S10	VBE-BGA, VDP,	28
		TM-WRENCH-16-12	●	S12	VDS, VCA,	28
		TM-WRENCH-20-15	●	S15	VBO, VBL, VBN, HPAV06-S	40
Open wrenches for 2 flute heads		TM-WRENCH-4E-05	●	S05	VRB, VRC, VFX**-02, VBB-BM, VBB-BG, VBB-SG, VCP, VGC, VCW, VCR	7
		TM-WRENCH-5E-06	●	S06		10
		TM-WRENCH-7E-08	●	S08		15
		TM-WRENCH-8E-10	●	S10		28
		TM-WRENCH-9E-12	●	S12		28
90° adaptor for Torx bits		INSERT-TOOL-9X12MM	●	-	-	-
Torx bits sockets		BIT-SOCKET-T20-DRIVE	●	S05, S06	VFM120, VTB135, VTB160W2.00, VTB165W2.00	7, 10
		BIT-SOCKET-T25-DRIVE	●	S06	VFM160, VTB160W3.00, VTB160W4.00, VTB165W3.00, VTB165W4.00	10
		BIT-SOCKET-T30-DRIVE	●	S08	VTB195	15
		BIT-SOCKET-T40-DRIVE	●	S08, S10	VFM200, VST277, VTB225	15, 28
		BIT-SOCKET-T50-DRIVE	●	S08, S10	VFM250, VTB250	15, 28

CAUTIONARY POINTS IN USE

- The cutting heads specified by Tungaloy must be used. Avoid using alternate heads that are not Tungaloy products as this will damage the shank and can cause severe accident or injury.
- Before setting the head, clean the connection screw with an air blast or a wiping cloth to remove chips and other foreign matter that may remain.
- Do not apply the lubricant to the connection screw.
- Please use the correct wrench with the correct cutting head. Tighten the head slowly until the face of the head contacts the shank. (Please refer to the picture shown on the right.) Do not re-tightening or over-tightening. Excessive tightening may cause the cutting head to break.
- Do not apply excessive force or a hammer when tightening or exchanging the cutting heads.

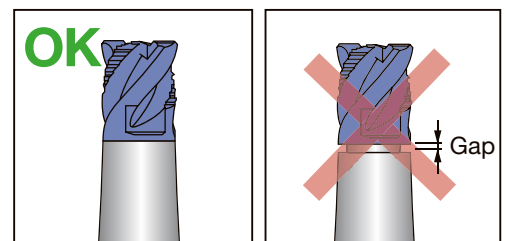

Grade
Insert
Ext. Toolholder
Int. Toolholder
Threading
Grooving
Shaper
Endmill
Drilling Tool
Technical Reference

9. Drilling Tool



Drilling Tool

Exchangeable head drill

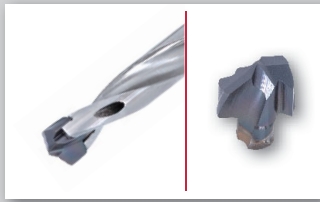

ADDMEISTER

Exchangeable head drill series



ø4 mm - ø5.9 mm / L/D = 3, 5

9-2, 9-4

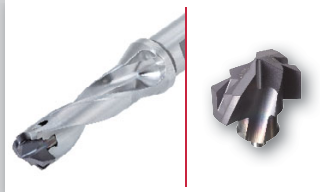

DRILLMEISTER

Exchangeable head drill series



ø6 mm - ø16.9 mm / L/D = 1.5, 2, 3, 3.5, 5, 6

9-2, 9-5

Solid drill



SOLIDDRILL

High performance solid carbide drill

9 - 22



DSM

ø0.1 mm - ø3 mm / L/D = 5, 10, 15

9-22, 9-23



DSW

ø3 mm - ø12 mm / L/D = 3, 5

9-24

Indexable drill



TUNGDRILLTWISTED

Indexable drill with 4-corner inserts for various drilling applications



ø12.5 mm - ø20 mm / L/D = 2, 3

9-28



Exchangeable head drills for unparalleled tool life and machining performance

- Helical margin to prevent chip adhesion between the body and the hole during machining
- Tool body made from highest grade of steel with superior hardness for high wear resistance
- Wide variety of geometries for every drilling application
- Advanced grade options ensure stable, long tool life
- Internal coolant channels supply efficient cooling and lubrication during the drilling process

ADD M^{EISTER} DRILL
Tool diameter: $\varnothing 4$ - $\varnothing 5.9$ mm

DRILLMEISTER
Tool diameter: $\varnothing 6$ - $\varnothing 25.9$ mm

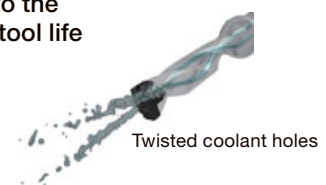
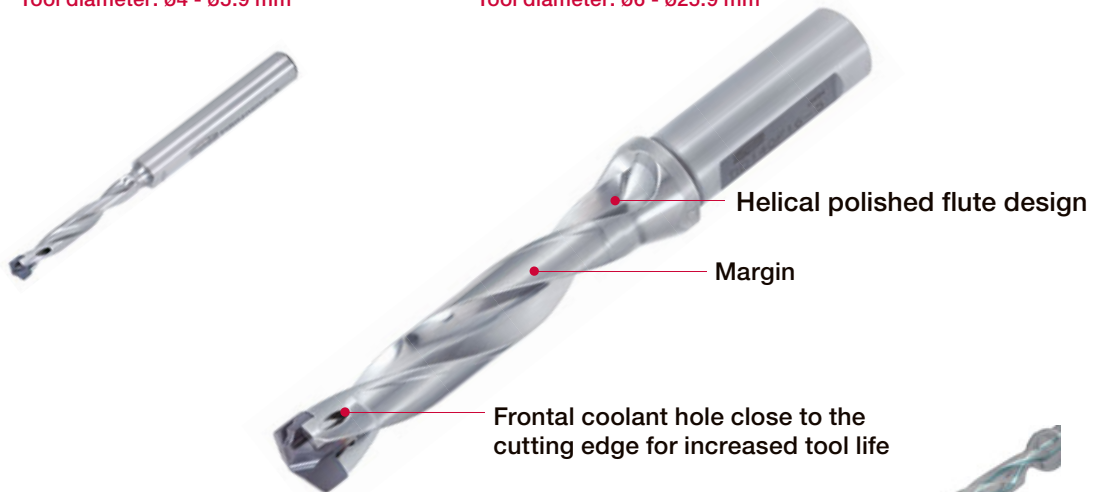





Quick and precise head changing with advanced self-clamping system

- Drilling head pocket designed to withstand high machining cutting conditions
- Allows easy and fast head indexing, minimizing machine downtime

Reference pages: **9-3**

General drilling - Quick Guide

★ : First choice
☆ : Second choice

Tool series	Designation	Appearance	Tool diameter	Effective Cutting edge	L/D	Coolant supply	IT class	Workpiece material					Remark	Page
								P	M	N	S	H		
ADDMASTER DRILL	TID		ø4 - ø5.9	2	3 5	Int.	8 - 10	★	★	★	★	★	Exchangeable head drill	9-4
DRILLMEISTER	TID TIDC TIDCF		ø6 - ø16.9	2	1.5 2 3 3.5 5 6	Int. / Ext.	8 - 10	★	★	★	★	★	Exchangeable head drill	9-5
SOLIDDRILL	DSM		ø0.1 - ø3	2	5 10 15	Ext.	9 - 10	★	★	☆	☆	☆	Solid drill	9-22
	DSW		ø3 - ø12	2	3 5	Int. / Ext.	9 - 10	★	★	☆	★	☆	Solid drill	9-24
TUNGDRILL TWISTED	TDX		ø12.5 - ø20	1	2 3	Int.	11 - 13	★	★	☆	★	★	Indexable drill	9-28

Introducing Special Drilling Tools and Their Drawing System

- Introducing an innovative solution for creating drawings of specialized drilling tools, which was previously a time-consuming process.
- Our newly developed service enables effortless creation of simple diagrams anytime, anywhere.
- Explore the "Drawing System for Special Drilling Tools"! By inputting essential tool details, you can swiftly generate straightforward diagrams illustrating special drilling tools with chamfering functions.



Grade
Insert
Ext. Toolholder
Int. Toolholder
Threading
Grooving
Shaper
Endmill
Drilling Tool
Technical Reference



ADDMASTER TID-R L/D=3

Exchangeable head drill, L/D = 3, Cylindrical shank

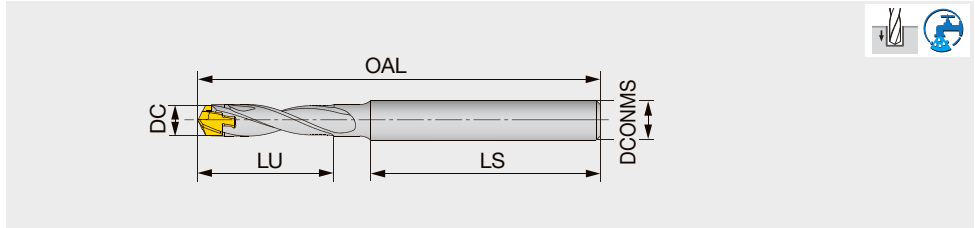

Designation	DC	DCONMS	LU	LS	OAL		Pocket size	Head
					DMP	DMC		
TID040R06-3	4 - 4.4	6	13	35	57.7	58.1	4	DM*040 - DM*044
TID045R06-3	4.5 - 4.9	6	14	35	59.7	59.9	4.5	DM*045 - DM*049
TID050R06-3	5 - 5.4	6	16	35	61.4	61.8	5	DM*050 - DM*054
TID055R06-3	5.5 - 5.9	6	17	35	64	64.3	5.5	DM*055 - DM*059

Tool diameter	Hole diameter tolerance*
ø4 - ø5.9	+0.04 / 0

*Just for reference

- An overall length (OAL) differs based on each head geometry.
- When using the drill at a higher feed rate, make sure to provide an axial support by placing the overhang adjusting screw at the drill shank end in the tool holder. This will prevent high thrust force from pushing the drill back into the holder during drilling.
- When axially adjusting the shank inside the holder to obtain a required drill overhang, make sure the shank length remaining inside the holder does not come short of the minimum clamping length (LSCN) specified by the holder supplier.

TID-R L/D=5

Exchangeable head drill, L/D = 5, Cylindrical shank

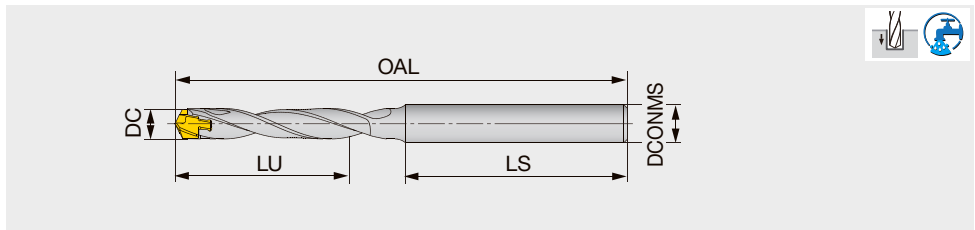

Designation	DC	DCONMS	LU	LS	OAL		Pocket size	Head
					DMP	DMC		
TID040R06-5	4 - 4.4	6	21	35	65.7	66.1	4	DM*040 - DM*044
TID045R06-5	4.5 - 4.9	6	23	35	68.7	68.9	4.5	DM*045 - DM*049
TID050R06-5	5 - 5.4	6	26	35	71.3	71.6	5	DM*050 - DM*054
TID055R06-5	5.5 - 5.9	6	28	35	74.2	74.5	5.5	DM*055 - DM*059

Tool diameter	Hole diameter tolerance*
ø4 - ø5.9	+0.05 / 0

*Just for reference

- An overall length (OAL) differs based on each head geometry.
- When using the drill at a higher feed rate, make sure to provide an axial support by placing the overhang adjusting screw at the drill shank end in the tool holder. This will prevent high thrust force from pushing the drill back into the holder during drilling.
- When axially adjusting the shank inside the holder to obtain a required drill overhang, make sure the shank length remaining inside the holder does not come short of the minimum clamping length (LSCN) specified by the holder supplier.

SPARE PARTS

Designation	Clamping key
TID040..., TID045...	K-TID4-4.99
TID050..., TID055...	K-TID5-5.99

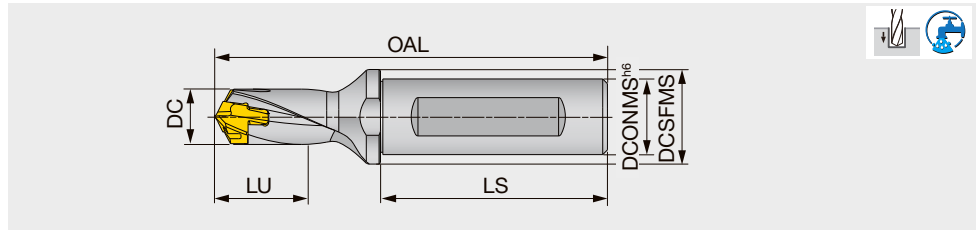

Designation	DC	DCONMS	DCSFMS	LU	LS	OAL			Pocket size	Head
						DMP/H/N	DMC	DMF		
TID060F12-1.5	6 - 6.4	12	16	10	45	67.9	68	67	6	DM*060 - DM*064
TID065F12-1.5	6.5 - 6.9	12	16	11	45	68.9	69.1	68	6.5	DM*065 - DM*069
TID070F12-1.5	7 - 7.4	12	16	12	45	70	70.4	69.1	7	DM*070 - DM*074
TID075F12-1.5	7.5 - 7.9	12	16	13	45	70.7	71.2	69.8	7	DM*075 - DM*079
TID080F12-1.5	8 - 8.9	12	16	14	45	72.3	72.4	71.4	8	DM*080 - DM*089
TID090F12-1.5	9 - 9.9	12	16	16	45	74.2	74.3	73.1	9	DM*090 - DM*099
TID100F16-1.5	10 - 10.9	16	20	17	48	79.1	79.7	77.7	10	DM*100 - DM*109
TID110F16-1.5	11 - 11.9	16	20	19	48	81	81.6	79.4	11	DM*110 - DM*119
TID120F16-1.5	12 - 12.9	16	20	20	48	82.8	83.4	81.2	12	DM*120 - DM*129
TID130F16-1.5	13 - 13.9	16	20	22	48	84.9	85.7	83	13	DM*130 - DM*139
TID140F16-1.5	14 - 14.9	16	20	24	48	89	89.8	87	14	DM*140 - DM*149
TID150F20-1.5	15 - 15.9	20	25	26	50	96	96.9	93.9	15	DM*150 - DM*159
TID160F20-1.5	16 - 16.9	20	25	27	50	99.1	100.1	96.8	16	DM*160 - DM*169
TID170F20-1.5	17 - 17.9	20	25	29	50	102.2	103.2	99.7	17	DM*170 - DM*179

Tool diameter	Hole diameter tolerance*
ø6 - ø17.9	+0.03 / 0

*Just for reference

- An overall length (OAL) differs based on each head geometry.
 - For drill diameters from ø8 - ø9.9 mm, the drill shoulder to shank bottom distance when a DMC drill head is mounted is 0.3 mm shorter when compared with a DMP head of the equivalent sizes. The distances are the same for the DMC and DMP drill heads in other diameters than the above.

SPARE PARTS



Designation	Clamping key
TID060... - TID090...	K-TID6-9.99
TID100... - TID160...	K-TID10-19.99

Reference pages: Head → 9-14, Sleeve → 9-21
 Standard cutting conditions → 9-20

TID-R-2E L/D=2

Exchangeable head drill, L/D = 2, Cylindrical shank, for external coolant supply

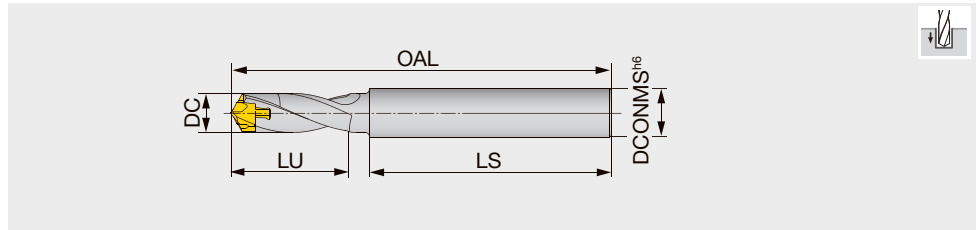

Designation	DC	DCONMS	LU	LS	OAL			Pocket size	Head
					DMP/H/N	DMC	DMF		
TID060R8-2E	6 - 6.4	8	12	45	66.1	66.2	65.2	6	DM*060 - DM*064
TID065R8-2E	6.5 - 6.9	8	13	45	67.2	67.3	66.3	6.5	DM*065 - DM*069
TID070R8-2E	7 - 7.4	8	13	45	68	68.4	67.1	7	DM*070 - DM*074
TID075R8-2E	7.5 - 7.9	8	14	45	69	69.4	68.1	7	DM*075 - DM*079
TID080R10-2E	8 - 8.9	10	15	50	75.2	75.3	74.3	8	DM*080 - DM*089
TID090R10-2E	9 - 9.9	10	17	50	77.4	77.5	76.3	9	DM*090 - DM*099
TID100R12-2E	10 - 10.9	12	22	60	94.3	94.9	92.9	10	DM*100 - DM*109
TID110R12-2E	11 - 11.9	12	24	60	96.5	97.1	94.9	11	DM*110 - DM*119
TID120R14-2E	12 - 12.9	14	26	65	103.6	104.2	102	12	DM*120 - DM*129
TID130R14-2E	13 - 13.9	14	27	65	108.8	109.6	106.9	13	DM*130 - DM*139
TID140R16-2E	14 - 14.9	16	29	70	115	115.8	113	14	DM*140 - DM*149
TID150R16-2E	15 - 15.9	16	32	70	118	118.9	115.9	15	DM*150 - DM*159
TID160R18-2E	16 - 16.9	18	33	70	122.2	123.2	119.9	16	DM*160 - DM*169

Tool diameter	Hole diameter tolerance*
ø6 - ø16.9	+0.04 / 0

*Just for reference

- An overall length (OAL) differs based on each head geometry.
- When using the drill at a higher feed rate, make sure to provide an axial support by placing the overhang adjusting screw at the drill shank end in the tool holder. This will prevent high thrust force from pushing the drill back into the holder during drilling.
- When axially adjusting the shank inside the holder to obtain a required drill overhang, make sure the shank length remaining inside the holder does not come short of the minimum clamping length (LSCN) specified by the holder supplier.
- For drill diameters from ø8 - ø9.9 mm, the drill shoulder to shank bottom distance when a DMC drill head is mounted is 0.3 mm shorter when compared with a DMP head of the equivalent sizes. The distances are the same for the DMC and DMP drill heads in other diameters than the above.

SPARE PARTS

Designation	Clamping key
TID060... - TID095...	K-TID6-9.99
TID100... - TID160...	K-TID10-19.99

Reference pages: Head → 9-14

Standard cutting conditions → 9-20

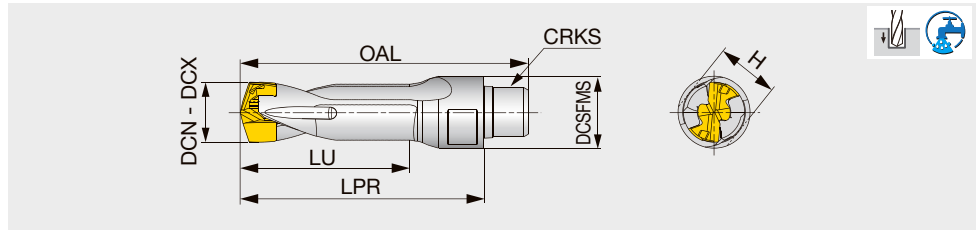

Designation	DC	DCSFMS	LU	LPR	OAL			CRKS	Pocket size	H	Head
					DMP	DMC	DMF				
TID065S06-2	6.5 - 6.9	10	14.5	27.15	33.45	33.6	32.58	S06	6.5	8	DM*065
TID085S06-2	8.5 - 8.9	10	19.5	33.15	39.45	39.55	38.59	S06	8.5	8	DM*085
TID105S08-2	10.5 - 10.9	12	23.5	40.55	48.05	48.67	46.72	S08	10.5	10	DM*105

Tool diameter	Hole diameter tolerance*
ø6.5 - ø10.9	+0.04 / 0

*Just for reference

SPARE PARTS



Designation	Clamping key
TID065S06-2, TID085S06-2	K-TID6-9.99
TID105S08-2	K-TID10-19.99

Designation	Wrench*	
TID065S06-2, TID085S06-2	KEYV-S06	
TID105S08-2	KEYV-S08	

*Sold separately

TID L/D=3

Exchangeable head drill, L/D = 3, flange type

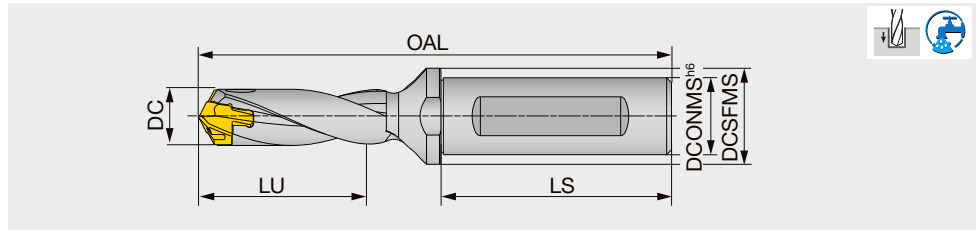

Designation	DC	DCONMS	DCSFMS	LU	LS	OAL			Pocket size	Head
						DMP/H/N	DMC	DMF		
TID060F12-3	6 - 6.4	12	16	19	45	76.9	77	76	6	DM*060 - DM*064
TID065F12-3	6.5 - 6.9	12	16	21	45	78.7	78.8	77.8	6.5	DM*065 - DM*069
TID070F12-3	7 - 7.4	12	16	22	45	80.5	80.9	79.6	7	DM*070 - DM*074
TID075F12-3	7.5 - 7.9	12	16	24	45	82	82.4	81.1	7	DM*075 - DM*079
TID080F12-3	8 - 8.4	12	16	26	45	84.3	84.4	83.4	8	DM*080 - DM*084
TID085F12-3	8.5 - 8.9	12	16	28	45	85.8	85.9	84.9	8	DM*085 - DM*089
TID090F12-3	9 - 9.4	12	16	29	45	87.7	87.8	86.6	9	DM*090 - DM*094
TID095F12-3	9.5 - 9.9	12	16	31	45	89.2	89.3	88.1	9	DM*095 - DM*099
TID100F16-3	10 - 10.4	16	20	32	48	94.1	94.7	92.7	10	DM*100 - DM*104
TID105F16-3	10.5 - 10.9	16	20	34	48	95.6	96.2	94.2	10	DM*105 - DM*109
TID110F16-3	11 - 11.4	16	20	35	48	97.5	98.1	95.9	11	DM*110 - DM*114
TID115F16-3	11.5 - 11.9	16	20	37	48	99	99.6	97.4	11	DM*115 - DM*119
TID120F16-3	12 - 12.4	16	20	38	48	100.8	101.4	99.2	12	DM*120 - DM*124
TID125F16-3	12.5 - 12.9	16	20	39	48	102.3	102.9	100.7	12	DM*125 - DM*129
TID130F16-3	13 - 13.4	16	20	41	48	104.4	105.2	102.5	13	DM*130 - DM*134
TID135F16-3	13.5 - 13.9	16	20	44	48	105.9	106.7	104	13	DM*135 - DM*139
TID140F16-3	14 - 14.4	16	20	45	48	110	110.8	108	14	DM*140 - DM*144
TID145F16-3	14.5 - 14.9	16	20	47	48	111.5	112.3	109.5	14	DM*145 - DM*149
TID150F20-3	15 - 15.9	20	25	48	50	118.5	119.4	116.4	15	DM*150 - DM*159
TID160F20-3	16 - 16.9	20	25	51	50	123.1	124.1	120.8	16	DM*160 - DM*169

Tool diameter	Hole diameter tolerance*
ø6 - ø16.9	+0.04 / 0

- An overall length (OAL) differs based on each head geometry.
 - For drill diameters from ø8 - ø9.9 mm, the drill shoulder to shank bottom distance when a DMC drill head is mounted is 0.3 mm shorter when compared with a DMP head of the equivalent sizes. The distances are the same for the DMC and DMP drill heads in other diameters than the above.

*Just for reference

SPARE PARTS



Designation	Clamping key
TID060... - TID095...	K-TID6-9.99
TID100... - TID160...	K-TID10-19.99

Reference pages: Head → 9-14, Sleeve → 9-21
 Standard cutting conditions → 9-20

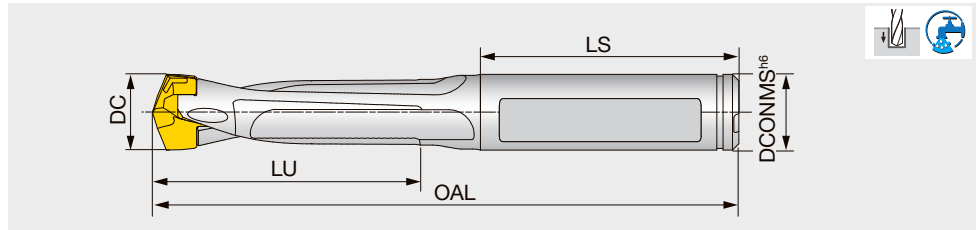

Designation	DC	DCONMS	LU	LS	OAL			Pocket size	Head
					DMP/H/N	DMC	DMF		
TIDC075C8-3	7.5 - 7.9	8	23	36	70.1	70.6	69.2	7	DM*075 - DM*079
TIDC080C8-3	8 - 8.4	8	24	36	70.6	70.8	69.7	8	DM*080 - DM*084
TIDC085C9-3	8.5 - 8.9	9	26	36	72.8	73	71.9	8	DM*085 - DM*089
TIDC090C9-3	9 - 9.4	9	27	36	74.7	74.9	73.7	9	DM*090 - DM*094
TIDC095C10-3	9.5 - 9.9	10	29	36	76.2	76.4	75.2	9	DM*095 - DM*099
TIDC100C10-3	10 - 10.4	10	32	41	86.1	86.7	84.8	10	DM*100 - DM*104
TIDC105C11-3	10.5 - 10.9	11	33	41	87.6	88.2	86.3	10	DM*105 - DM*109
TIDC110C11-3	11 - 11.4	11	35	41	89.5	90.2	88	11	DM*110 - DM*114
TIDC115C12-3	11.5 - 11.9	12	37	41	91	91.7	89.5	11	DM*115 - DM*119
TIDC120C12-3	12 - 12.4	12	38	41	92.8	93.4	91.2	12	DM*120 - DM*124
TIDC125C13-3	12.5 - 12.9	13	40	46	98.3	98.9	96.7	12	DM*125 - DM*129
TIDC130C13-3	13 - 13.4	13	41	47	102.4	103.2	100.5	13	DM*130 - DM*134
TIDC135C14-3	13.5 - 13.9	14	43	43	99.9	100.7	98	13	DM*135 - DM*139
TIDC140C14-3	14 - 14.4	14	45	44	103	103.8	101	14	DM*140 - DM*144
TIDC145C15-3	14.5 - 14.9	15	46	45	105.5	106.3	103.5	14	DM*145 - DM*149
TIDC150C15-3	15 - 15.9	15	48	45	107.5	108.4	105.4	15	DM*150 - DM*159
TIDC160C16-3	16 - 16.9	16	51	48	117.5	118.5	115.2	16	DM*160 - DM*169

Tool diameter	Hole diameter tolerance*
ø7.5 - ø16.9	+0.04 / 0

*Just for reference

- An overall length (OAL) differs based on each head geometry.
- When using the drill at a higher feed rate, make sure to provide an axial support by placing the overhang adjusting screw at the drill shank end in the tool holder. This will prevent high thrust force from pushing the drill back into the holder during drilling.
- For drill diameters from ø8 - ø9.9 mm, the drill shoulder to shank bottom distance when a DMC drill head is mounted is 0.3 mm shorter when compared with a DMP head of the equivalent sizes. The distances are the same for the DMC and DMP drill heads in other diameters than the above.
- When axially adjusting the shank inside the holder to obtain a required drill overhang, make sure the shank length remaining inside the holder does not come short of the minimum clamping length (LSCN) specified by the holder supplier.

SPARE PARTS



Designation	Clamping key
TIDC075... - TIDC099...	K-TID6-9.99
TIDC100... - TIDC160...	K-TID10-19.99

Reference pages: Head → 9-14

Standard cutting conditions → 9-20

TID-R L/D=3.5

Exchangeable head drill, L/D = 3.5, Cylindrical shank

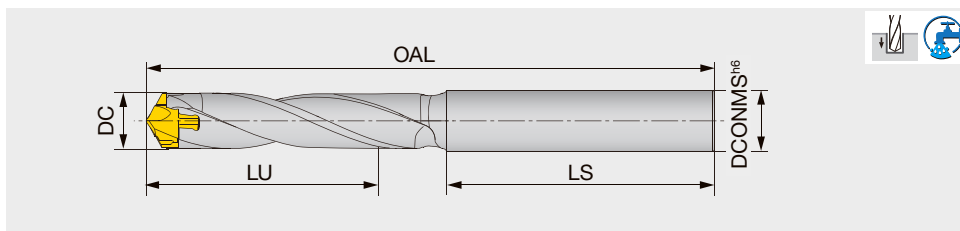

Designation	DC	DCONMS	LU	LS	OAL			Pocket size	Head
					DMP/H/N	DMC	DMF		
TID060R8-3.5	6 - 6.4	8	21	45	75.6	75.8	74.8	6	DM*060 - DM*064
TID065R8-3.5	6.5 - 6.9	8	23	45	77.5	77.6	76.6	6.5	DM*065 - DM*069
TID070R8-3.5	7 - 7.4	8	25	45	79.1	79.5	78.2	7	DM*070 - DM*074
TID075R8-3.5	7.5 - 7.9	8	26	45	80.8	81.3	80	7	DM*075 - DM*079
TID080R10-3.5	8 - 8.4	10	28	50	87.8	87.9	86.9	8	DM*080 - DM*084
TID085R10-3.5	8.5 - 8.9	10	30	50	89.5	89.7	88.6	8	DM*085 - DM*089
TID090R10-3.5	9 - 9.4	10	32	50	91.4	91.6	90.4	9	DM*090 - DM*094
TID095R10-3.5	9.5 - 9.9	10	33	50	93.2	93.3	92.1	9	DM*095 - DM*099
TID100R12-3.5	10 - 10.4	12	42	60	114	114.7	112.7	10	DM*100 - DM*104
TID105R12-3.5	10.5 - 10.9	12	44	60	115.7	116.3	114.4	10	DM*105 - DM*109
TID110R12-3.5	11 - 11.4	12	46	65	123.1	123.8	121.6	11	DM*110 - DM*114
TID115R12-3.5	11.5 - 11.9	12	48	65	124.8	125.4	123.2	11	DM*115 - DM*119
TID120R14-3.5	12 - 12.4	14	50	65	127.2	127.8	125.6	12	DM*120 - DM*124
TID125R14-3.5	12.5 - 12.9	14	52	65	128.8	129.5	127.3	12	DM*125 - DM*129
TID130R14-3.5	13 - 13.4	14	54	65	132.7	133.5	130.9	13	DM*130 - DM*134
TID135R14-3.5	13.5 - 13.9	14	56	65	134.4	135.2	132.5	13	DM*135 - DM*139
TID140R16-3.5	14 - 14.4	16	58	70	142.2	143	140.2	14	DM*140 - DM*144
TID145R16-3.5	14.5 - 14.9	16	60	70	143.8	144.7	141.9	14	DM*145 - DM*149
TID150R16-3.5	15 - 15.9	16	64	70	148.4	149.4	146.3	15	DM*150 - DM*159
TID160R18-3.5	16 - 16.9	18	68	70	153.9	154.9	151.7	16	DM*160 - DM*169

Tool diameter	Hole diameter tolerance*
ø6 - ø16.9	+0.04 / 0

*Just for reference

- An overall length (OAL) differs based on each head geometry.
- When using the drill at a higher feed rate, make sure to provide an axial support by placing the overhang adjusting screw at the drill shank end in the tool holder. This will prevent high thrust force from pushing the drill back into the holder during drilling.
- When axially adjusting the shank inside the holder to obtain a required drill overhang, make sure the shank length remaining inside the holder does not come short of the minimum clamping length (LSCN) specified by the holder supplier.
- For drill diameters from ø8 - ø9.9 mm, the drill shoulder to shank bottom distance when a DMC drill head is mounted is 0.3 mm shorter when compared with a DMP head of the equivalent sizes. The distances are the same for the DMC and DMP drill heads in other diameters than the above.

SPARE PARTS

Designation	Clamping key
TID060... - TID095...	K-TID6-9.99
TID100... - TID160...	K-TID10-19.99

Reference pages: Head → 9-14

Standard cutting conditions → 9-20

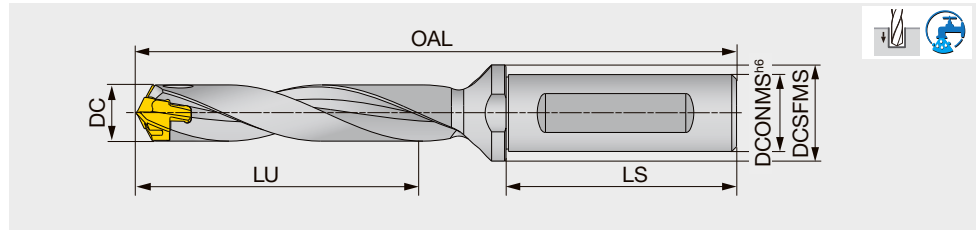

Designation	DC	DCONMS	DCSFMS	LU	LS	OAL			Pocket size	Head
						DMP/H/N	DMC	DMF		
TID060F12-5	6 - 6.4	12	16	31	45	88.9	89	88	6	DM*060 - DM*064
TID065F12-5	6.5 - 6.9	12	16	34	45	91.7	91.8	90.8	6.5	DM*065 - DM*069
TID070F12-5	7 - 7.4	12	16	36	45	94.5	94.9	93.6	7	DM*070 - DM*074
TID075F12-5	7.5 - 7.9	12	16	39	45	97	97.4	96.1	7	DM*075 - DM*079
TID080F12-5	8 - 8.4	12	16	42	45	100.3	100.4	99.4	8	DM*080 - DM*084
TID085F12-5	8.5 - 8.9	12	16	45	45	102.8	102.9	101.9	8	DM*085 - DM*089
TID090F12-5	9 - 9.4	12	16	47	45	105.7	105.8	104.6	9	DM*090 - DM*094
TID095F12-5	9.5 - 9.9	12	16	50	45	108.2	108.3	107.1	9	DM*095 - DM*099
TID100F16-5	10 - 10.4	16	20	52	48	114.1	114.7	112.7	10	DM*100 - DM*104
TID105F16-5	10.5 - 10.9	16	20	55	48	116.6	117.2	115.2	10	DM*105 - DM*109
TID110F16-5	11 - 11.4	16	20	57	48	119.5	120.1	117.9	11	DM*110 - DM*114
TID115F16-5	11.5 - 11.9	16	20	60	48	122	122.6	120.4	11	DM*115 - DM*119
TID120F16-5	12 - 12.4	16	20	62	48	124.8	125.4	123.2	12	DM*120 - DM*124
TID125F16-5	12.5 - 12.9	16	20	64	48	127.3	127.9	125.7	12	DM*125 - DM*129
TID130F16-5	13 - 13.4	16	20	67	48	130.4	131.2	128.5	13	DM*130 - DM*134
TID135F16-5	13.5 - 13.9	16	20	71	48	132.9	133.7	131	13	DM*135 - DM*139
TID140F16-5	14 - 14.4	16	20	73	48	138	138.8	136	14	DM*140 - DM*144
TID145F16-5	14.5 - 14.9	16	20	76	48	140.5	141.3	138.5	14	DM*145 - DM*149
TID150F20-5	15 - 15.9	20	25	78	50	148.5	149.4	146.4	15	DM*150 - DM*159
TID160F20-5	16 - 16.9	20	25	83	50	155.1	156.1	152.8	16	DM*160 - DM*169

Tool diameter	Hole diameter tolerance*
ø6 - ø16.9	+0.05 / 0

*Just for reference

- An overall length (OAL) differs based on each head geometry.
 - For drill diameters from ø8 - ø9.9 mm, the drill shoulder to shank bottom distance when a DMC drill head is mounted is 0.3 mm shorter when compared with a DMP head of the equivalent sizes. The distances are the same for the DMC and DMP drill heads in other diameters than the above.

SPARE PARTS



Designation	Clamping key
TID060... - TID095...	K-TID6-9.99
TID100... - TID160...	K-TID10-19.99

Reference pages: Head → 9-14, Sleeve → 9-21
 Standard cutting conditions → 9-20

TIDC L/D=5

Exchangeable head drill, L/D = 5, Cylindrical shank, for chamfering adapter

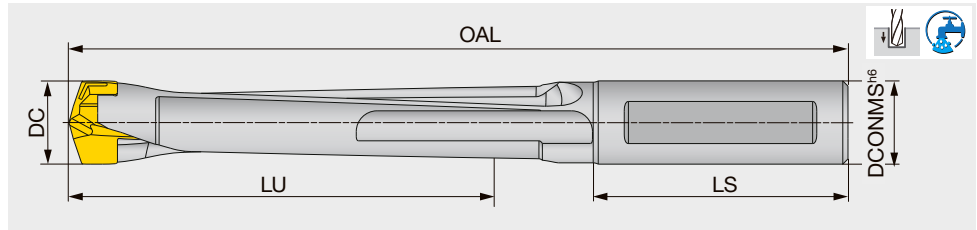

Designation	DC	DCONMS	LU	LS	OAL			Pocket size	Head
					DMP/H/N	DMC	DMF		
TIDC075C8-5	7.5 - 7.9	8	38	36	85.1	85.6	84.2	7	DM*075 - DM*079
TIDC080C8-5	8 - 8.4	8	40	36	92.3	92.5	91.4	8	DM*080 - DM*084
TIDC085C9-5	8.5 - 8.9	9	43	36	89.8	90	88.9	8	DM*085 - DM*089
TIDC090C9-5	9 - 9.4	9	45	36	92.7	92.9	91.7	9	DM*090 - DM*094
TIDC095C10-5	9.5 - 9.9	10	48	36	95.2	95.4	94.2	9	DM*095 - DM*099
TIDC100C10-5	10 - 10.4	10	52	41	106.1	106.7	104.8	10	DM*100 - DM*104
TIDC105C11-5	10.5 - 10.9	11	54	41	108.6	109.2	107.3	10	DM*105 - DM*109
TIDC110C11-5	11 - 11.4	11	57	41	111.5	112.2	110	11	DM*110 - DM*114
TIDC115C12-5	11.5 - 11.9	12	60	41	114	114.7	112.5	11	DM*115 - DM*119
TIDC120C12-5	12 - 12.4	12	62	41	116.8	117.4	115.2	12	DM*120 - DM*124
TIDC125C13-5	12.5 - 12.9	13	65	46	124.3	124.9	122.7	12	DM*125 - DM*129
TIDC130C13-5	13 - 13.4	13	67	47	128.4	129.2	126.5	13	DM*130 - DM*134
TIDC135C14-5	13.5 - 13.9	14	70	43	126.9	127.7	125	13	DM*135 - DM*139
TIDC140C14-5	14 - 14.4	14	73	44	131	131.8	129	14	DM*140 - DM*144
TIDC145C15-5	14.5 - 14.9	15	75	45	134.5	135.3	132.5	14	DM*145 - DM*149
TIDC150C15-5	15 - 15.9	15	78	45	137.5	138.4	135.4	15	DM*150 - DM*159
TIDC160C16-5	16 - 16.9	16	83	48	149.5	150.5	147.2	16	DM*160 - DM*169

Tool diameter	Hole diameter tolerance*
ø7.5 - ø16.9	+0.05 / 0

*Just for reference

- An overall length (OAL) differs based on each head geometry.
- When using the drill at a higher feed rate, make sure to provide an axial support by placing the overhang adjusting screw at the drill shank end in the tool holder. This will prevent high thrust force from pushing the drill back into the holder during drilling.
- For drill diameters from ø8 - ø9.9 mm, the drill shoulder to shank bottom distance when a DMC drill head is mounted is 0.3 mm shorter when compared with a DMP head of the equivalent sizes. The distances are the same for the DMC and DMP drill heads in other diameters than the above.
- When axially adjusting the shank inside the holder to obtain a required drill overhang, make sure the shank length remaining inside the holder does not come short of the minimum clamping length (LSCN) specified by the holder supplier.

SPARE PARTS

Designation	Clamping key
TIDC075... - TIDC099...	K-TID6-9.99
TIDC100... - TIDC160...	K-TID10-19.99

Reference pages: Head → 9-14

Standard cutting conditions → 9-20

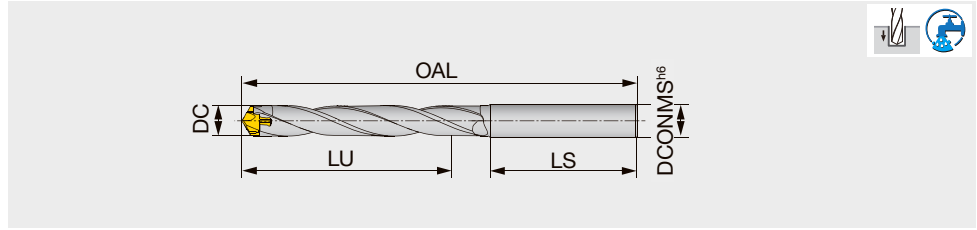

Designation	DC	DCONMS	LU	LS	OAL			Pocket size	Head
					DMP/H/N	DMC	DMF		
TID060R8-6	6 - 6.4	8	36	45	91.6	91.8	90.8	6	DM*060 - DM*064
TID065R8-6	6.5 - 6.9	8	39	45	94.7	94.9	93.9	6.5	DM*065 - DM*069
TID070R8-6	7 - 7.4	8	42	45	97.6	98	96.7	7	DM*070 - DM*074
TID075R8-6	7.5 - 7.9	8	45	45	100.6	101	99.7	7	DM*075 - DM*079
TID080R10-6	8 - 8.4	10	48	50	108.8	108.9	107.9	8	DM*080 - DM*084
TID085R10-6	8.5 - 8.9	10	51	50	111.8	111.9	110.9	8	DM*085 - DM*089
TID090R10-6	9 - 9.4	10	54	50	114.9	115.1	113.9	9	DM*090 - DM*094
TID095R10-6	9.5 - 9.9	10	57	50	117.9	118.1	116.9	9	DM*095 - DM*099
TID100R12-6	10 - 10.4	12	68	60	140	140.7	138.7	10	DM*100 - DM*104
TID105R12-6	10.5 - 10.9	12	71	60	142.9	143.6	141.6	10	DM*105 - DM*109
TID110R12-6	11 - 11.4	12	75	65	151.6	152.3	150.1	11	DM*110 - DM*114
TID115R12-6	11.5 - 11.9	12	78	65	154.5	155.2	153	11	DM*115 - DM*119
TID120R14-6	12 - 12.4	14	81	65	158.2	158.8	156.6	12	DM*120 - DM*124
TID125R14-6	12.5 - 12.9	14	84	65	161.1	161.7	159.5	12	DM*125 - DM*129
TID130R14-6	13 - 13.4	14	88	65	166.2	167	164.4	13	DM*130 - DM*134
TID135R14-6	13.5 - 13.9	14	91	65	169.2	169.9	167.3	13	DM*135 - DM*139
TID140R16-6	14 - 14.4	16	94	70	178.2	179	176.2	14	DM*140 - DM*144
TID145R16-6	14.5 - 14.9	16	97	70	181.1	181.9	179.1	14	DM*145 - DM*149
TID150R16-6	15 - 15.9	16	104	70	188.2	189.1	186.1	15	DM*150 - DM*159
TID160R18-6	16 - 16.9	18	110	70	196.2	197.2	193.9	16	DM*160 - DM*169

Tool diameter	Hole diameter tolerance*
ø6 - ø16.9	+0.05 / 0

*Just for reference

- An overall length (OAL) differs based on each head geometry.
- When using the drill at a higher feed rate, make sure to provide an axial support by placing the overhang adjusting screw at the drill shank end in the tool holder. This will prevent high thrust force from pushing the drill back into the holder during drilling.
- When axially adjusting the shank inside the holder to obtain a required drill overhang, make sure the shank length remaining inside the holder does not come short of the minimum clamping length (LSCN) specified by the holder supplier.
- For drill diameters from ø8 - ø9.9 mm, the drill shoulder to shank bottom distance when a DMC drill head is mounted is 0.3 mm shorter when compared with a DMP head of the equivalent sizes. The distances are the same for the DMC and DMP drill heads in other diameters than the above.

SPARE PARTS



Designation	Clamping key
TID060... - TID095...	K-TID6-9.99
TID100... - TID160...	K-TID10-19.99

DRILL HEAD

DMP (General purpose)

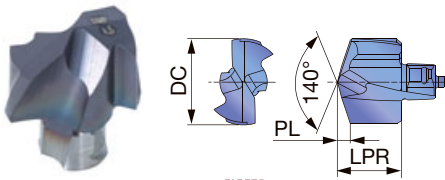

ADD MORE DRILL
DMP040 - DMP059

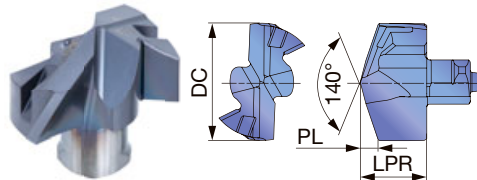

DRILLMEISTER
DMP060 - DMP259

Tool diameter	Head diameter tolerance
ø4 - ø17.9	+0.018 / 0
ø18 - ø25.9	+0.021 / 0

P	Steel	☆	★
M	Stainless	☆	★
K	Cast iron	☆	★
N	Non-ferrous		
S	Superalloys	☆	★
H	Hard materials	☆	★

P	Steel	☆	★
M	Stainless	☆	★
K	Cast iron	☆	★
N	Non-ferrous		
S	Superalloys	☆	★
H	Hard materials	☆	★

★ : First choice
☆ : Second choice

Designation	DC	LPR	Coated		PL	Body
			AH725	AH9130		
DMP040	4	3.1	●		0.62	TID*040...
DMP041	4.1	3.1	●		0.64	TID*040...
DMP042	4.2	3.1	●		0.66	TID*040...
DMP043	4.3	3.1	●		0.67	TID*040...
DMP044	4.4	3.1	●		0.69	TID*040...
DMP045	4.5	3.55	●		0.66	TID*045...
DMP046	4.6	3.55	●		0.68	TID*045...
DMP047	4.7	3.55	●		0.70	TID*045...
DMP048	4.8	3.55	●		0.71	TID*045...
DMP049	4.9	3.55	●		0.73	TID*045...
DMP050	5	3.7	●		0.73	TID*050...
DMP051	5.1	3.7	●		0.75	TID*050...
DMP052	5.2	3.7	●		0.77	TID*050...
DMP053	5.3	3.7	●		0.78	TID*050...
DMP054	5.4	3.7	●		0.8	TID*050...
DMP055	5.5	3.85	●		0.81	TID*055...
DMP056	5.6	3.85	●		0.83	TID*055...
DMP057	5.7	3.85	●		0.85	TID*055...
DMP058	5.8	3.85	●		0.86	TID*055...
DMP059	5.9	3.85	●		0.88	TID*055...
DMP060	6	3.85	●	●	1.09	TID*060...
DMP061	6.1	3.85	●	●	1.11	TID*060...
DMP062	6.2	3.85	●	●	1.13	TID*060...
DMP063	6.3	3.85	●	●	1.14	TID*060...
DMP064	6.4	3.85	●	●	1.16	TID*060...
DMP065	6.5	4.15	●	●	1.27	TID*065...
DMP066	6.6	4.15	●	●	1.29	TID*065...
DMP067	6.7	4.15	●	●	1.31	TID*065...
DMP068	6.8	4.15	●	●	1.33	TID*065...
DMP069	6.9	4.15	●	●	1.34	TID*065...
DMP070	7	4.45	●	●	1.03	TID*070...
DMP071	7.1	4.45	●	●	1.05	TID*070...
DMP072	7.2	4.45	●	●	1.07	TID*070...
DMP073	7.3	4.45	●	●	1.08	TID*070...
DMP074	7.4	4.45	●	●	1.1	TID*070...
DMP075	7.5	4.45	●	●	1.12	TID*075...
DMP076	7.6	4.45	●	●	1.14	TID*075...
DMP077	7.7	4.45	●	●	1.16	TID*075...
DMP078	7.8	4.45	●	●	1.18	TID*075...
DMP079	7.9	4.45	●	●	1.19	TID*075...
DMP080	8	5.25	●	●	1.2	TID*080...
DMP081	8.1	5.25	●	●	1.22	TID*080...
DMP082	8.2	5.25	●	●	1.24	TID*080...

Designation	DC	LPR	Coated		PL	Body
			AH725	AH9130		
DMP083	8.3	5.25	●	●	1.25	TID*080...
DMP084	8.4	5.25	●	●	1.27	TID*080...
DMP085	8.5	5.25	●	●	1.29	TID*085...
DMP086	8.6	5.25	●	●	1.31	TID*085...
DMP087	8.7	5.25	●	●	1.33	TID*085...
DMP088	8.8	5.25	●	●	1.35	TID*085...
DMP089	8.9	5.25	●	●	1.36	TID*085...
DMP090	9	5.65	●	●	1.37	TID*090...
DMP091	9.1	5.65	●	●	1.39	TID*090...
DMP092	9.2	5.65	●	●	1.41	TID*090...
DMP093	9.3	5.65	●	●	1.42	TID*090...
DMP094	9.4	5.65	●	●	1.44	TID*090...
DMP095	9.5	5.65	●	●	1.46	TID*095...
DMP096	9.6	5.65	●	●	1.48	TID*095...
DMP097	9.7	5.65	●	●	1.5	TID*095...
DMP098	9.8	5.65	●	●	1.52	TID*095...
DMP099	9.9	5.65	●	●	1.53	TID*095...
DMP100	10	6.05	●	●	1.47	TID*100...
DMP101	10.1	6.05	●	●	1.49	TID*100...
DMP102	10.2	6.05	●	●	1.51	TID*100...
DMP103	10.3	6.05	●	●	1.52	TID*100...
DMP104	10.4	6.05	●	●	1.54	TID*100...
DMP105	10.5	6.05	●	●	1.56	TID*105...
DMP106	10.6	6.05	●	●	1.58	TID*105...
DMP107	10.7	6.05	●	●	1.6	TID*105...
DMP108	10.8	6.05	●	●	1.62	TID*105...
DMP109	10.9	6.05	●	●	1.63	TID*105...
DMP110	11	6.45	●	●	1.67	TID*110...
DMP111	11.1	6.45	●	●	1.69	TID*110...
DMP112	11.2	6.45	●	●	1.71	TID*110...
DMP113	11.3	6.45	●	●	1.72	TID*110...
DMP114	11.4	6.45	●	●	1.74	TID*110...
DMP115	11.5	6.45	●	●	1.76	TID*115...
DMP116	11.6	6.45	●	●	1.78	TID*115...
DMP117	11.7	6.45	●	●	1.8	TID*115...
DMP118	11.8	6.45	●	●	1.82	TID*115...
DMP119	11.9	6.45	●	●	1.83	TID*115...
DMP120	12	6.8	●	●	1.82	TID*120...
DMP121	12.1	6.8	●	●	1.84	TID*120...
DMP122	12.2	6.8	●	●	1.86	TID*120...
DMP123	12.3	6.8	●	●	1.87	TID*120...
DMP124	12.4	6.8	●	●	1.89	TID*120...
DMP125	12.5	6.8	●	●	1.91	TID*125...

ø4 - ø16.9 = 2 pieces per package

● : Line up

DMC (High precision hole making)



ADD M DRILL
DMC040 - DMC059

Tool diameter Head diameter tolerance
ø4 - ø16.9 +0.018 / 0

P	Steel	☆	★
M	Stainless	☆	★
K	Cast iron	☆	★
N	Non-ferrous		
S	Superalloys	☆	★
H	Hard materials	☆	★

P	Steel	★
M	Stainless	★
K	Cast iron	★
N	Non-ferrous	☆
S	Superalloys	★
H	Hard materials	★

Designation	DC	LPR	Coated		PL	Body
			AH725	AH9130		
DMP126	12.6	6.8	●	●	1.93	TID*125...
DMP127	12.7	6.8	●	●	1.95	TID*125...
DMP128	12.8	6.8	●	●	1.97	TID*125...
DMP129	12.9	6.8	●	●	1.98	TID*125...
DMP130	13	7.4	●	●	1.96	TID*130...
DMP131	13.1	7.4	●	●	1.98	TID*130...
DMP132	13.2	7.4	●	●	2	TID*130...
DMP133	13.3	7.4	●	●	2.01	TID*130...
DMP134	13.4	7.4	●	●	2.03	TID*130...
DMP135	13.5	7.4	●	●	2.05	TID*135...
DMP136	13.6	7.4	●	●	2.07	TID*135...
DMP137	13.7	7.4	●	●	2.09	TID*135...
DMP138	13.8	7.4	●	●	2.11	TID*135...
DMP139	13.9	7.4	●	●	2.12	TID*135...
DMP140	14	7.95	●	●	2.12	TID*140...
DMP141	14.1	7.95	●	●	2.14	TID*140...
DMP142	14.2	7.95	●	●	2.16	TID*140...
DMP143	14.3	7.95	●	●	2.17	TID*140...
DMP144	14.4	7.95	●	●	2.19	TID*140...
DMP145	14.5	7.95	●	●	2.21	TID*145...
DMP146	14.6	7.95	●	●	2.23	TID*145...
DMP147	14.7	7.95	●	●	2.25	TID*145...
DMP148	14.8	7.95	●	●	2.27	TID*145...
DMP149	14.9	7.95	●	●	2.28	TID*145...
DMP150	15	8.53	●	●	2.27	TID*150...
DMP151	15.1	8.53	●	●	2.29	TID*150...
DMP152	15.2	8.53	●	●	2.31	TID*150...
DMP153	15.3	8.53	●	●	2.32	TID*150...
DMP154	15.4	8.53	●	●	2.34	TID*150...
DMP155	15.5	8.53	●	●	2.36	TID*150...
DMP156	15.6	8.53	●	●	2.38	TID*150...
DMP157	15.7	8.53	●	●	2.4	TID*150...
DMP158	15.8	8.53	●	●	2.42	TID*150...
DMP159	15.9	8.53	●	●	2.43	TID*150...
DMP160	16	9.1	●	●	2.42	TID*160...
DMP161	16.1	9.1	●	●	2.44	TID*160...
DMP162	16.2	9.1	●	●	2.46	TID*160...
DMP163	16.3	9.1	●	●	2.47	TID*160...
DMP164	16.4	9.1	●	●	2.49	TID*160...
DMP165	16.5	9.1	●	●	2.51	TID*160...
DMP166	16.6	9.1	●	●	2.53	TID*160...
DMP167	16.7	9.1	●	●	2.55	TID*160...
DMP168	16.8	9.1	●	●	2.57	TID*160...
DMP169	16.9	9.1	●	●	2.58	TID*160...

Designation	DC	LPR	Coated		PL	Body
			AH9130			
DMC040	4	3.51	●		0.86	TID*040...
DMC041	4.1	3.51	●		0.88	TID*040...
DMC042	4.2	3.51	●		0.9	TID*040...
DMC043	4.3	3.51	●		0.92	TID*040...
DMC044	4.4	3.51	●		0.94	TID*040...
DMC045	4.5	3.81	●		0.97	TID*045...
DMC046	4.6	3.81	●		0.99	TID*045...
DMC047	4.7	3.81	●		1.01	TID*045...
DMC048	4.8	3.81	●		1.03	TID*045...
DMC049	4.9	3.81	●		1.05	TID*045...
DMC050	5	4.14	●		1.09	TID*050...
DMC051	5.1	4.14	●		1.11	TID*050...
DMC052	5.2	4.14	●		1.13	TID*050...
DMC053	5.3	4.14	●		1.15	TID*050...
DMC054	5.4	4.14	●		1.17	TID*050...
DMC055	5.5	4.17	●		1.22	TID*055...
DMC056	5.6	4.17	●		1.24	TID*055...
DMC057	5.7	4.17	●		1.26	TID*055...
DMC058	5.8	4.17	●		1.28	TID*055...
DMC059	5.9	4.17	●		1.3	TID*055...
DMC060	6	4	●		1.24	TID*060...
DMC061	6.1	4	●		1.26	TID*060...
DMC062	6.2	4	●		1.28	TID*060...
DMC063	6.3	4	●		1.3	TID*060...
DMC064	6.4	4	●		1.32	TID*060...
DMC065	6.5	4.3	●		1.33	TID*065...
DMC066	6.6	4.3	●		1.35	TID*065...
DMC067	6.7	4.3	●		1.37	TID*065...
DMC068	6.8	4.3	●		1.39	TID*065...
DMC069	6.9	4.3	●		1.41	TID*065...
DMC070	7	4.9	●		1.48	TID*070...
DMC071	7.1	4.9	●		1.5	TID*070...
DMC072	7.2	4.9	●		1.52	TID*070...
DMC073	7.3	4.9	●		1.54	TID*070...
DMC074	7.4	4.9	●		1.56	TID*070...
DMC075	7.5	4.9	●		1.58	TID*075...
DMC076	7.6	4.9	●		1.6	TID*075...
DMC077	7.7	4.9	●		1.62	TID*075...
DMC078	7.8	4.9	●		1.64	TID*075...
DMC079	7.9	4.9	●		1.66	TID*075...
DMC080	8	5.4	●		1.62	TID*080...
DMC081	8.1	5.4	●		1.64	TID*080...
DMC082	8.2	5.4	●		1.66	TID*080...
DMC083	8.3	5.4	●		1.68	TID*080...
DMC084	8.4	5.4	●		1.7	TID*080...
DMC085	8.5	5.4	●		1.72	TID*085...
DMC086	8.6	5.4	●		1.74	TID*085...
DMC087	8.7	5.4	●		1.76	TID*085...
DMC088	8.8	5.4	●		1.78	TID*085...
DMC089	8.9	5.4	●		1.8	TID*085...

ø4 - ø16.9 = 2 pieces per package

● : Line up

DRILL HEAD

DMC (High precision hole making)

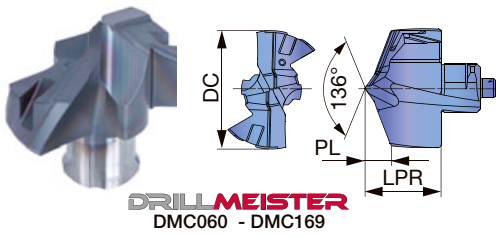

Tool diameter **Head diameter tolerance**
 ø4 - ø16.9 +0.018 / 0

P	Steel	★		
M	Stainless	★		
K	Cast iron	★		
N	Non-ferrous	☆		
S	Superalloys	★		
H	Hard materials	★		

P	Steel	★		
M	Stainless	★		
K	Cast iron	★		
N	Non-ferrous	☆		
S	Superalloys	★		
H	Hard materials	★		

★ : First choice
 ☆ : Second choice

Designation	DC	LPR	Coated		PL	Body
			AH9130			
DMC090	9	5.8	●		1.91	TID*090...
DMC091	9.1	5.8	●		1.93	TID*090...
DMC092	9.2	5.8	●		1.95	TID*090...
DMC093	9.3	5.8	●		1.97	TID*090...
DMC094	9.4	5.8	●		1.99	TID*090...
DMC095	9.5	5.8	●		2.01	TID*095...
DMC096	9.6	5.8	●		2.03	TID*095...
DMC097	9.7	5.8	●		2.05	TID*095...
DMC098	9.8	5.8	●		2.07	TID*095...
DMC099	9.9	5.8	●		2.09	TID*095...
DMC100	10	6.67	●		2.09	TID*100...
DMC101	10.1	6.67	●		2.11	TID*100...
DMC102	10.2	6.67	●		2.13	TID*100...
DMC103	10.3	6.67	●		2.15	TID*100...
DMC104	10.4	6.67	●		2.17	TID*100...
DMC105	10.5	6.67	●		2.19	TID*105...
DMC106	10.6	6.67	●		2.21	TID*105...
DMC107	10.7	6.67	●		2.23	TID*105...
DMC108	10.8	6.67	●		2.25	TID*105...
DMC109	10.9	6.67	●		2.27	TID*105...
DMC110	11	7.1	●		2.32	TID*110...
DMC111	11.1	7.1	●		2.34	TID*110...
DMC112	11.2	7.1	●		2.36	TID*110...
DMC113	11.3	7.1	●		2.38	TID*110...
DMC114	11.4	7.1	●		2.4	TID*110...
DMC115	11.5	7.1	●		2.42	TID*115...
DMC116	11.6	7.1	●		2.44	TID*115...
DMC117	11.7	7.1	●		2.46	TID*115...
DMC118	11.8	7.1	●		2.48	TID*115...
DMC119	11.9	7.1	●		2.5	TID*115...
DMC120	12	7.43	●		2.45	TID*120...
DMC121	12.1	7.43	●		2.47	TID*120...
DMC122	12.2	7.43	●		2.49	TID*120...
DMC123	12.3	7.43	●		2.51	TID*120...
DMC124	12.4	7.43	●		2.53	TID*120...
DMC125	12.5	7.43	●		2.55	TID*125...
DMC126	12.6	7.43	●		2.57	TID*125...
DMC127	12.7	7.43	●		2.59	TID*125...
DMC128	12.8	7.43	●		2.61	TID*125...
DMC129	12.9	7.43	●		2.63	TID*125...
DMC130	13	8.15	●		2.71	TID*130...
DMC131	13.1	8.15	●		2.73	TID*130...
DMC132	13.2	8.15	●		2.75	TID*130...
DMC133	13.3	8.15	●		2.77	TID*130...
DMC134	13.4	8.15	●		2.79	TID*130...
DMC135	13.5	8.15	●		2.81	TID*135...
DMC136	13.6	8.15	●		2.83	TID*135...
DMC137	13.7	8.15	●		2.85	TID*135...
DMC138	13.8	8.15	●		2.87	TID*135...

Designation	DC	LPR	Coated		PL	Body
			AH9130			
DMC139	13.9	8.15	●		2.89	TID*135...
DMC140	14	8.76	●		2.93	TID*140...
DMC141	14.1	8.76	●		2.95	TID*140...
DMC142	14.2	8.76	●		2.97	TID*140...
DMC143	14.3	8.76	●		2.99	TID*140...
DMC144	14.4	8.76	●		3.01	TID*140...
DMC145	14.5	8.76	●		3.03	TID*145...
DMC146	14.6	8.76	●		3.05	TID*145...
DMC147	14.7	8.76	●		3.07	TID*145...
DMC148	14.8	8.76	●		3.09	TID*145...
DMC149	14.9	8.76	●		3.11	TID*145...
DMC150	15	9.44	●		3.18	TID*150...
DMC151	15.1	9.44	●		3.2	TID*150...
DMC152	15.2	9.44	●		3.22	TID*150...
DMC153	15.3	9.44	●		3.24	TID*150...
DMC154	15.4	9.44	●		3.26	TID*150...
DMC155	15.5	9.44	●		3.28	TID*150...
DMC156	15.6	9.44	●		3.3	TID*150...
DMC157	15.7	9.44	●		3.32	TID*150...
DMC158	15.8	9.44	●		3.34	TID*150...
DMC159	15.9	9.44	●		3.36	TID*150...
DMC160	16	10.07	●		3.39	TID*160...
DMC161	16.1	10.07	●		3.41	TID*160...
DMC162	16.2	10.07	●		3.43	TID*160...
DMC163	16.3	10.07	●		3.45	TID*160...
DMC164	16.4	10.07	●		3.47	TID*160...
DMC165	16.5	10.07	●		3.49	TID*160...
DMC166	16.6	10.07	●		3.51	TID*160...
DMC167	16.7	10.07	●		3.53	TID*160...
DMC168	16.8	10.07	●		3.55	TID*160...
DMC169	16.9	10.07	●		3.57	TID*160...

ø4 - ø16.9 = 2 pieces per package

● : Line up

DMF (Flat geometry head)

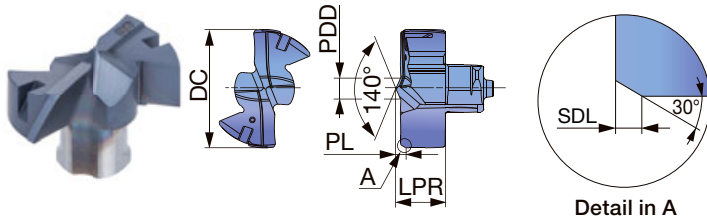

Tool diameter	Head diameter tolerance
ø6 - ø16.9	+0.018 / 0

P	Steel	★		
M	Stainless	★		
K	Cast iron	★		
N	Non-ferrous	☆		
S	Superalloys	★		
H	Hard materials	★		

P	Steel	★		
M	Stainless	★		
K	Cast iron	★		
N	Non-ferrous	☆		
S	Superalloys	★		
H	Hard materials	★		

★ : First choice
☆ : Second choice

Designation	DC	LPR	Coated		SDL	PL	PDD	Body
			AH9130					
DMF060	6	3.01	●		0.4	0.61	1.15	TID*060...
DMF061	6.1	3.01	●		0.4	0.61	1.15	TID*060...
DMF062	6.2	3.01	●		0.4	0.61	1.15	TID*060...
DMF063	6.3	3.01	●		0.4	0.61	1.15	TID*060...
DMF064	6.4	3.01	●		0.4	0.61	1.15	TID*060...
DMF065	6.5	3.28	●		0.4	0.68	1.54	TID*065...
DMF066	6.6	3.28	●		0.4	0.68	1.54	TID*065...
DMF067	6.7	3.28	●		0.4	0.68	1.54	TID*065...
DMF068	6.8	3.28	●		0.4	0.68	1.54	TID*065...
DMF069	6.9	3.28	●		0.4	0.68	1.54	TID*065...
DMF070	7	3.58	●		0.4	0.68	1.54	TID*070...
DMF071	7.1	3.58	●		0.4	0.68	1.54	TID*070...
DMF072	7.2	3.58	●		0.4	0.68	1.54	TID*070...
DMF073	7.3	3.58	●		0.4	0.68	1.54	TID*070...
DMF074	7.4	3.58	●		0.4	0.68	1.54	TID*070...
DMF075	7.5	3.58	●		0.4	0.68	1.54	TID*075...
DMF076	7.6	3.58	●		0.4	0.68	1.54	TID*075...
DMF078	7.8	3.58	●		0.4	0.68	1.54	TID*075...
DMF079	7.9	3.58	●		0.4	0.68	1.54	TID*075...
DMF080	8	4.39	●		0.7	1.09	2.44	TID*080...
DMF081	8.1	4.39	●		0.7	1.09	2.44	TID*080...
DMF082	8.2	4.39	●		0.7	1.09	2.44	TID*080...
DMF083	8.3	4.39	●		0.7	1.09	2.44	TID*080...
DMF084	8.4	4.39	●		0.7	1.09	2.44	TID*080...
DMF085	8.5	4.39	●		0.7	1.09	2.44	TID*085...
DMF086	8.6	4.39	●		0.7	1.09	2.44	TID*085...
DMF087	8.7	4.39	●		0.7	1.09	2.44	TID*085...
DMF088	8.8	4.39	●		0.7	1.09	2.44	TID*085...
DMF089	8.9	4.39	●		0.7	1.09	2.44	TID*085...
DMF090	9	4.61	●		0.7	1.11	2.55	TID*090...
DMF091	9.1	4.61	●		0.7	1.11	2.55	TID*090...
DMF092	9.2	4.61	●		0.7	1.11	2.55	TID*090...
DMF093	9.3	4.61	●		0.7	1.11	2.55	TID*090...
DMF094	9.4	4.61	●		0.7	1.11	2.55	TID*090...
DMF095	9.5	4.61	●		0.7	1.11	2.55	TID*095...
DMF096	9.6	4.61	●		0.7	1.11	2.55	TID*095...
DMF097	9.7	4.61	●		0.7	1.11	2.55	TID*095...
DMF098	9.8	4.61	●		0.7	1.11	2.55	TID*095...
DMF099	9.9	4.61	●		0.7	1.11	2.55	TID*095...
DMF100	10	4.72	●		0.7	1.17	2.89	TID*100...
DMF101	10.1	4.72	●		0.7	1.17	2.89	TID*100...
DMF103	10.3	4.72	●		0.7	1.17	2.89	TID*100...
DMF104	10.4	4.72	●		0.7	1.17	2.89	TID*100...
DMF105	10.5	4.72	●		0.7	1.17	2.89	TID*105...
DMF106	10.6	4.72	●		0.7	1.17	2.89	TID*105...
DMF107	10.7	4.72	●		0.7	1.17	2.89	TID*105...
DMF108	10.8	4.72	●		0.7	1.17	2.89	TID*105...
DMF110	11	4.9	●		0.7	1.25	2.98	TID*110...
DMF115	11.5	4.9	●		0.7	1.25	2.98	TID*115...
DMF117	11.7	4.9	●		0.7	1.25	2.98	TID*115...
DMF120	12	5.21	●		0.7	1.26	3.13	TID*120...
DMF121	12.1	5.21	●		0.7	1.26	3.13	TID*120...

Designation	DC	LPR	Coated		SDL	PL	PDD	Body
			AH9130					
DMF122	12.2	5.21	●		0.7	1.26	3.13	TID*120...
DMF123	12.3	5.21	●		0.7	1.26	3.13	TID*120...
DMF124	12.4	5.21	●		0.7	1.26	3.13	TID*120...
DMF125	12.5	5.21	●		0.7	1.26	3.13	TID*125...
DMF126	12.6	5.21	●		0.7	1.26	3.13	TID*125...
DMF127	12.7	5.21	●		0.7	1.26	3.13	TID*125...
DMF130	13	5.53	●		0.7	1.28	3.52	TID*130...
DMF131	13.1	5.53	●		0.7	1.28	3.52	TID*130...
DMF133	13.3	5.53	●		0.7	1.28	3.52	TID*130...
DMF135	13.5	5.53	●		0.7	1.28	3.52	TID*135...
DMF137	13.7	5.53	●		0.7	1.28	3.52	TID*135...
DMF138	13.8	5.53	●		0.7	1.28	3.52	TID*135...
DMF139	13.9	5.53	●		0.7	1.28	3.52	TID*135...
DMF140	14	5.96	●		0.7	1.31	3.81	TID*140...
DMF141	14.1	5.96	●		0.7	1.31	3.81	TID*140...
DMF142	14.2	5.96	●		0.7	1.31	3.81	TID*140...
DMF143	14.3	5.96	●		0.7	1.31	3.81	TID*140...
DMF144	14.4	5.96	●		0.7	1.31	3.81	TID*140...
DMF145	14.5	5.96	●		0.7	1.31	3.81	TID*145...
DMF150	15	6.43	●		0.7	1.35	4.24	TID*150...
DMF152	15.2	6.43	●		0.7	1.35	4.24	TID*150...
DMF155	15.5	6.43	●		0.7	1.35	4.24	TID*150...
DMF157	15.7	6.43	●		0.7	1.35	4.24	TID*150...
DMF158	15.8	6.43	●		0.7	1.35	4.24	TID*150...
DMF160	16	6.84	●		0.7	1.39	4.06	TID*160...
DMF161	16.1	6.84	●		0.7	1.39	4.06	TID*160...
DMF165	16.5	6.84	●		0.7	1.39	4.06	TID*160...
DMF167	16.7	6.84	●		0.7	1.39	4.06	TID*160...

ø6 - ø16.9 = 2 pieces per package

● : Line up

Grade
Insert
Ext. Toolholder
Int. Toolholder
Threading
Grooving
Shaper
Endmill
Drilling Tool
Technical Reference

DRILL HEAD

DMH (High strength cutting edge)

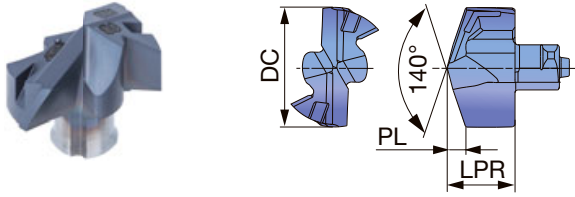

Tool diameter **Head diameter tolerance**
 $\phi 6 - \phi 16.9$ $+0.018 / -0.005$

P	Steel	★		
M	Stainless	★		
K	Cast iron	★		
N	Non-ferrous			
S	Superalloys	★		
H	Hard materials	★		

P	Steel	★		
M	Stainless	★		
K	Cast iron	★		
N	Non-ferrous			
S	Superalloys	★		
H	Hard materials	★		

★ : First choice

Designation	DC	LPR	Coated		PL	Body
			AH9130			
DMH060	6	3.85	●		1.09	TID*060...
DMH068	6.8	4.15	●		1.33	TID*065...
DMH070	7	4.45	●		1.03	TID*070...
DMH075	7.5	4.45	●		1.12	TID*075...
DMH080	8	5.25	●		1.2	TID*080...
DMH085	8.5	5.25	●		1.29	TID*085...
DMH086	8.6	5.25	●		1.31	TID*085...
DMH087	8.7	5.25	●		1.33	TID*085...
DMH088	8.8	5.25	●		1.35	TID*085...
DMH090	9	5.65	●		1.37	TID*090...
DMH095	9.5	5.65	●		1.46	TID*095...
DMH097	9.7	5.65	●		1.5	TID*095...
DMH100	10	6.05	●		1.47	TID*100...
DMH101	10.1	6.05	●		1.49	TID*100...
DMH103	10.3	6.05	●		1.52	TID*100...
DMH104	10.4	6.05	●		1.54	TID*100...
DMH105	10.5	6.05	●		1.56	TID*105...
DMH106	10.6	6.05	●		1.58	TID*105...
DMH107	10.7	6.05	●		1.6	TID*105...
DMH108	10.8	6.05	●		1.62	TID*105...
DMH110	11	6.45	●		1.67	TID*110...
DMH111	11.1	6.45	●		1.69	TID*110...
DMH112	11.2	6.45	●		1.71	TID*110...
DMH113	11.3	6.45	●		1.72	TID*110...
DMH114	11.4	6.45	●		1.74	TID*110...
DMH115	11.5	6.45	●		1.76	TID*115...
DMH117	11.7	6.45	●		1.8	TID*115...
DMH118	11.8	6.45	●		1.82	TID*115...
DMH119	11.9	6.45	●		1.83	TID*115...
DMH120	12	6.8	●		1.82	TID*120...
DMH121	12.1	6.8	●		1.84	TID*120...
DMH122	12.2	6.8	●		1.86	TID*120...
DMH123	12.3	6.8	●		1.87	TID*120...
DMH124	12.4	6.8	●		1.89	TID*120...
DMH125	12.5	6.8	●		1.91	TID*125...
DMH126	12.6	6.8	●		1.93	TID*125...
DMH127	12.7	6.8	●		1.95	TID*125...
DMH128	12.8	6.8	●		1.97	TID*125...
DMH129	12.9	6.8	●		1.98	TID*125...
DMH130	13	7.4	●		1.96	TID*130...
DMH131	13.1	7.4	●		1.98	TID*130...
DMH132	13.2	7.4	●		2	TID*130...
DMH133	13.3	7.4	●		2.01	TID*130...
DMH134	13.4	7.4	●		2.03	TID*130...
DMH135	13.5	7.4	●		2.05	TID*135...
DMH136	13.6	7.4	●		2.07	TID*135...
DMH137	13.7	7.4	●		2.09	TID*135...
DMH138	13.8	7.4	●		2.11	TID*135...
DMH139	13.9	7.4	●		2.12	TID*135...
DMH140	14	7.95	●		2.12	TID*140...
DMH141	14.1	7.95	●		2.14	TID*140...
DMH142	14.2	7.95	●		2.16	TID*140...
DMH143	14.3	7.95	●		2.17	TID*140...

Designation	DC	LPR	Coated		PL	Body
			AH9130			
DMH144	14.4	7.95	●		2.19	TID*140...
DMH145	14.5	7.95	●		2.21	TID*145...
DMH146	14.6	7.95	●		2.23	TID*145...
DMH147	14.7	7.95	●		2.25	TID*145...
DMH150	15	8.53	●		2.27	TID*150...
DMH151	15.1	8.53	●		2.29	TID*150...
DMH152	15.2	8.53	●		2.31	TID*150...
DMH153	15.3	8.53	●		2.32	TID*150...
DMH154	15.4	8.53	●		2.34	TID*150...
DMH155	15.5	8.53	●		2.36	TID*150...
DMH156	15.6	8.53	●		2.38	TID*150...
DMH157	15.7	8.53	●		2.40	TID*150...
DMH158	15.8	8.53	●		2.42	TID*150...
DMH160	16	9.1	●		2.42	TID*160...
DMH162	16.2	9.1	●		2.46	TID*160...
DMH163	16.3	9.1	●		2.47	TID*160...
DMH165	16.5	9.1	●		2.51	TID*160...
DMH166	16.6	9.1	●		2.53	TID*160...
DMH167	16.7	9.1	●		2.55	TID*160...

$\phi 6 - \phi 16.9 = 2$ pieces per package

● : Line up

DMN Non-ferrous metals drilling

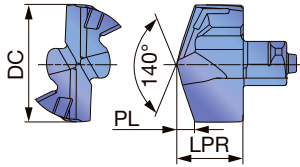

Tool diameter	Head diameter tolerance
ø6.8 - ø16.5	+0.01 / 0

P	Steel			
M	Stainless			
K	Cast iron			
N	Non-ferrous	★		
S	Superalloys			
H	Hard materials			

★ : First choice
☆ : Second choice

Designation	DC	LPR	Coated		PL	Body
			KS15F			
DMN068	6.8	4.15	●		1.33	TID*065...
DMN078	7.8	4.45	●		1.18	TID*075...
DMN080	8	5.25	●		1.2	TID*080...
DMN085	8.5	5.25	●		1.29	TID*085...
DMN088	8.8	5.25	●		1.35	TID*085...
DMN095	9.5	5.65	●		1.46	TID*095...
DMN100	10	6.05	●		1.47	TID*100...
DMN102	10.2	6.05	●		1.51	TID*100...
DMN105	10.5	6.05	●		1.56	TID*105...
DMN108	10.8	6.05	●		1.62	TID*105...
DMN110	11	6.45	●		1.67	TID*110...
DMN115	11.5	6.45	●		1.76	TID*115...
DMN120	12	6.8	●		1.82	TID*120...
DMN123	12.3	6.8	●		1.87	TID*120...
DMN125	12.5	6.8	●		1.91	TID*125...
DMN126	12.6	6.8	●		1.93	TID*125...
DMN127	12.7	6.8	●		1.95	TID*125...
DMN130	13	7.4	●		1.96	TID*130...
DMN135	13.5	7.4	●		2.05	TID*135...
DMN138	13.8	7.4	●		2.11	TID*135...
DMN140	14	7.95	●		2.12	TID*140...
DMN142	14.2	7.95	●		2.16	TID*140...
DMN145	14.5	7.95	●		2.21	TID*145...
DMN150	15	8.53	●		2.27	TID*150...
DMN152	15.2	8.53	●		2.31	TID*150...
DMN155	15.5	8.53	●		2.36	TID*150...
DMN158	15.8	8.53	●		2.42	TID*150...
DMN159	15.9	8.53	●		2.43	TID*150...
DMN160	16	9.1	●		2.42	TID*160...
DMN163	16.3	9.1	●		2.47	TID*160...
DMN165	16.5	9.1	●		2.51	TID*160...

ø6.8 - ø16.5 = 2 pieces per package

● : Line up

Grade

1

Insert

2

Ext. Toolholder

3

Int. Toolholder

4

Threading

5

Grooving

6

Shaper

7

Endmill

8

Drilling Tool

9

Technical Reference

10

STANDARD CUTTING CONDITIONS

ISO	Workpiece material	Hardness	Cutting speed Vc (m/min)	Feed: f (mm/rev)									
				Tool diameter: DC (mm)									
				ø4 - 4.4	ø4.5 - 4.9	ø5 - 5.9	ø6 - 7.9	ø8 - 9.9	ø10 - ø11.9	ø12 - ø13.9	ø14 - ø15.9	ø16 - ø16.9	
P	Low carbon steels (C < 0.3) SS400, SM490, S25C, etc. C15E4, E275A, E355D, etc.	- 200 HB	80 - 140	0.04 - 0.07	0.04 - 0.08	0.07 - 0.13	0.09 - 0.13	0.12 - 0.25	0.15 - 0.28	0.18 - 0.3	0.20 - 0.35	0.25 - 0.45	
	High carbon steels (C > 0.3) S45C, S55C, etc. C45, C55, etc.	- 300 HB	70 - 120	0.04 - 0.07	0.04 - 0.08	0.07 - 0.13	0.09 - 0.13	0.12 - 0.25	0.15 - 0.28	0.18 - 0.3	0.2 - 0.35	0.25 - 0.45	
	Low alloy steels SCM415, etc. 18CrMo4, etc.	- 200 HB	70 - 120	0.04 - 0.06	0.05 - 0.08	0.07 - 0.13	0.08 - 0.13	0.11 - 0.25	0.14 - 0.28	0.16 - 0.32	0.18 - 0.35	0.23 - 0.4	
	Alloy steels SCM440, SCR420, etc. 42CrMo4, 20Cr4, etc.	- 300 HB	40 - 90	0.04 - 0.07	0.05 - 0.08	0.07 - 0.13	0.08 - 0.13	0.11 - 0.25	0.14 - 0.28	0.16 - 0.32	0.18 - 0.35	0.23 - 0.4	
M	Stainless steels SUS304, SUS316, etc. X5CrNi18-9, X5CrNiMo17-12-2, etc.	- 250 HB	30 - 70	-	-	0.04 - 0.08	0.08 - 0.1	0.1 - 0.15	0.12 - 0.18	0.14 - 0.2	0.16 - 0.24	0.16 - 0.26	
K	Grey cast irons FC250, etc. GG25, etc.	150 - 250 HB	80 - 180	0.04 - 0.08	0.04 - 0.08	0.1 - 0.15	0.12 - 0.18	0.15 - 0.3	0.20 - 0.35	0.25 - 0.4	0.3 - 0.45	0.35 - 0.55	
	Ductile cast irons FCD700, etc. GGG70, etc.	150 - 250 HB	80 - 140	0.04 - 0.08	0.04 - 0.08	0.1 - 0.15	0.12 - 0.18	0.15 - 0.3	0.20 - 0.35	0.25 - 0.4	0.3 - 0.45	0.35 - 0.55	
N	Aluminium alloys ADC12, etc. AISi11Cu3, etc.	-	80 - 220	-	-	-	0.1 - 0.2	0.2 - 0.35	0.25 - 0.4	0.3 - 0.45	0.35 - 0.5	0.4 - 0.6	
S	Titanium alloys Ti-6Al-4V, etc.	- 40 HRC	20 - 50	-	-	-	0.05 - 0.07	0.06 - 0.12	0.08 - 0.15	0.1 - 0.28	0.12 - 0.2	0.14 - 0.22	
	Nickel-based alloys	- 40 HRC	20 - 50	-	-	-	0.05 - 0.07	0.06 - 0.11	0.08 - 0.13	0.1 - 0.15	0.12 - 0.18	0.12 - 0.22	
H	Hardened steel	- 50 HRC	20 - 50	-	-	-	0.05 - 0.07	0.06 - 0.12	0.08 - 0.15	0.1 - 0.18	0.12 - 0.2	0.14 - 0.22	

- Cutting conditions in the above table show standard cutting conditions
- Cutting conditions may change due to the rigidity and power of the machine and the workpiece material
- Machined hole diameter may change depending upon the rigidity of the machine tool or cutting conditions

Over 2xD drilling without internal coolant

At without internal coolant environment, external coolant supply is required. The cutting condition is recommended to reduced from listed condition depend on material and hole depth. Over 2xD drill, Step or pecking cycle operation is recommended in order to cooling cutting edge and chip evacuation.

2xD drilling in P material

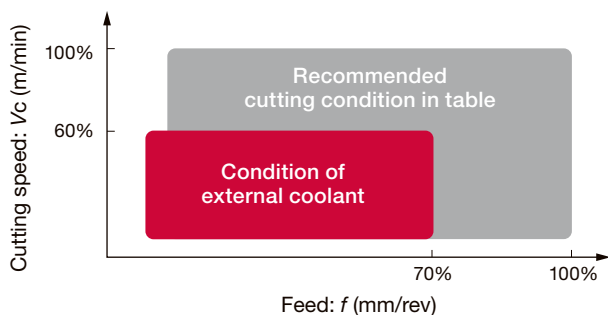

CRITERIA FOR THE END OF DRILL-BODY LIFE

For your safety, it is recommended to replace drill bodies that reached the fatigue life with new drill bodies. For measuring un-clamping torque, the exclusive Clamping key (sold separately) should be used. To determine the fatigue life, Measure the torque value required to unlock the drill head with a torque driver. When the torque value required is equal to or smaller than the values listed below for respective head sizes, replace the drill body with a new one.

Clamping key for measuring un-clamping torque:

KHS-TID10-19.99



* The clamping key can be connect with general torque drivers.



Head Designation	Recommended value of un-clamping torque that means usable limit of a drill body	
	(N·m)	(N·cm)
DM*100-109	0.2	20
DM*110-119	0.2	20
DM*120-129	0.25	25
DM*130-139	0.25	25
DM*140-149	0.3	30
DM*150-159	0.3	30
DM*160-169	0.35	35
DM*170-179	0.35	35
DM*180-189	0.4	40
DM*190-199	0.4	40

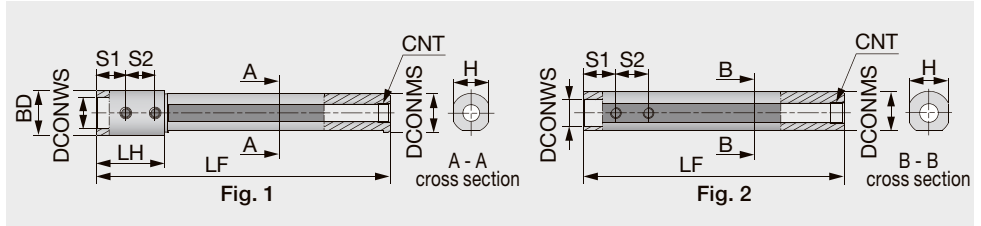

Designation	DCONMS	DCONWS	LF	LH	BD	H	S1	S2	CNT	Body	Fig.
BLM16-12LF	16	12	85	35	20	15.5	15	15	Rc1/8	TID***F12...	1
BLM19-12LF	19.05	12	140	35	23	18.5	15	15	Rc1/8	TID***F12...	1
BLM19-12SF	19.05	12	90	35	23	18.5	15	15	Rc1/8	TID***F12...	1
BLM19-16LF	19.05	16	140	35	23	18.5	15	15	Rc1/8	TID***F16...	1
BLM19-16SF	19.05	16	90	35	23	18.5	15	15	Rc1/8	TID***F16...	1
BLM20-12LR	20	12	120	-	-	19	15	15	Rc1/8	TID***F12...	2
BLM20-16LF	20	16	150	35	23	19	15	15	Rc1/8	TID***F16...	1
BLM22-12LR	22	12	120	-	-	21.5	15	15	Rc1/8	TID***F12...	2
BLM22-16LF	22	16	140	35	25	21.5	15	15	Rc1/8	TID***F16...	1
BLM25-12LR	25	12	115	-	-	24	15	15	Rc1/8	TID***F12...	2
BLM25-16LR	25	16	115	-	-	24	15	15	Rc1/8	TID***F16...	2
BLM25-20LF	25	20	150	35	28	24	15	15	Rc1/8	TID***F20...	1
BLM254-12LR	25.4	12	115	-	-	24.7	15	15	Rc1/8	TID***F12...	2
BLM254-12SR	25.4	12	75	-	-	24.7	15	15	Rc1/8	TID***F12...	2
BLM254-16LR	25.4	16	115	-	-	24.7	15	15	Rc1/8	TID***F16...	2
BLM254-16SR	25.4	16	75	-	-	24.7	15	15	Rc1/8	TID***F16...	2
BLM254-20LF	25.4	20	140	35	28	24.7	15	15	Rc1/8	TID***F20...	1
BLM32-12LR	32	12	120	-	-	31.5	15	15	Rc1/8	TID***F12...	2
BLM32-16LR	32	16	120	-	-	31.5	15	15	Rc1/8	TID***F16...	2
BLM32-20LR	32	20	120	-	-	31.5	15	15	Rc1/8	TID***F20...	2

SPARE PARTS

Designation	Clamping screw	Wrench
BLM16/19/20/22...	SR M5x4 FLAT	P-2.5
BLM25-12LR	SR M5x6 FLAT	P-2.5
BLM25-16LR, BLM25-20LF	SR M5x4 FLAT	P-2.5
BLM254-12LR, BLM254-12SR	SR M5x6 FLAT	P-2.5
BLM254-16LR, BLM254-16SR, BLM254-20LF	SR M5x4 FLAT	P-2.5
BLM32-12LR, BLM32-16LR	SR M5x6 FLAT	P-2.5
BLM32-20LR	SR M5x4 FLAT	P-2.5

Note for sleeve usage

- Please refer to the separate Tungaloy report and product catalog for cutting conditions
- Please refrain from using whistle notch and weldon type shanks from the viewpoint of clamping stability

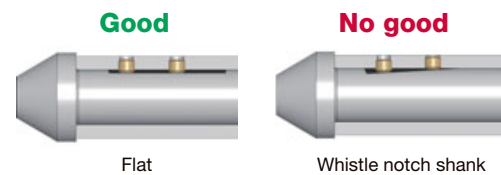

SOLIDDRILL

DSM

Micro solid drill, L/D = 5 - 15, without coolant hole

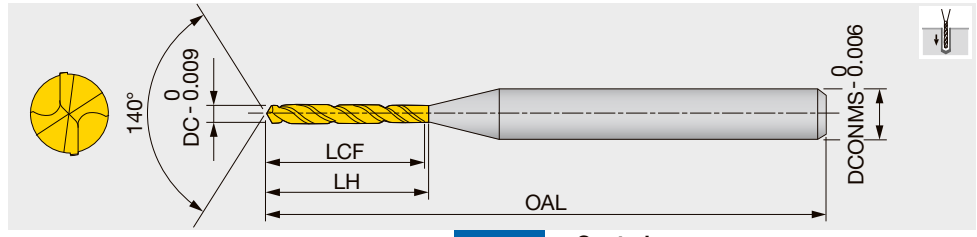

Designation	DC	Coated		DCONMS	LCF	LH	OAL	Designation	DC	Coated		DCONMS	LCF	LH	OAL
		YH170	YH180							YH170	YH180				
DSM0010G10	0.1	●		3	1.15	1.4	38	DSM0100G10	1	●		3	11.5	12.1	38
DSM0011G10	0.11	●		3	1.25	1.5	38	DSM0108G05	1.08	●		3	8	8.6	38
DSM0012G10	0.12	●		3	1.35	1.6	38	DSM0110G05	1.1	●		3	8	8.6	38
DSM0013G10	0.13	●		3	1.55	1.8	38	DSM0120G05	1.2	●		3	8.9	9.5	38
DSM0014G10	0.14	●		3	1.65	1.9	38	DSM0130G05	1.3	●		3	9.7	10.3	38
DSM0015G10	0.15	●		3	1.75	2	38	DSM0140G05	1.4	●		3	10.5	11.1	38
DSM0016G10	0.16	●		3	1.85	2.1	38	DSM0145G05	1.45	●		3	11.3	11.9	38
DSM0017G10	0.17	●		3	1.95	2.2	38	DSM0149G05	1.49	●		3	11.3	11.9	38
DSM0018G10	0.18	●		3	2.15	2.4	38	DSM0150G05	1.5	●		3	11.3	11.9	38
DSM0019G10	0.19	●		3	2.25	2.5	38	DSM0153G05	1.53	●		3	12.1	12.7	45
DSM0020G10	0.2	●		3	2.35	2.6	38	DSM0155G05	1.55	●		3	12.1	12.7	45
DSM0021G10	0.21	●		3	2.45	2.7	38	DSM0160G05	1.6	●		3	12.1	12.7	45
DSM0022G10	0.22	●		3	2.55	2.8	38	DSM0165G05	1.65	●		3	12.9	13.6	45
DSM0023G10	0.23	●		3	2.75	3	38	DSM0170G05	1.7	●		3	12.9	13.6	45
DSM0024G10	0.24	●		3	2.85	3.1	38	DSM0180G05	1.8	●		3	13.7	14.3	45
DSM0025G10	0.25	●		3	3	3.3	38	DSM0182G05	1.82	●		3	14.5	15.1	45
DSM0026G10	0.26	●		3	3.1	3.4	38	DSM0185G05	1.85	●		3	14.5	15.1	45
DSM0027G10	0.27	●		3	3.2	3.5	38	DSM0190G05	1.9	●		3	14.5	15.1	45
DSM0028G10	0.28	●		3	3.4	3.7	38	DSM0195G05	1.95	●		3	15.3	15.9	45
DSM0029G10	0.29	●		3	3.5	3.8	38	DSM0200G05	2	●		3	15.3	15.9	45
DSM0030G10	0.3	●		3	3.9	4.2	38	DSM0203G05	2.03	●		3	16.1	16.7	45
DSM0031G15	0.31	●		3	5.6	5.9	38	DSM0205G05	2.05	●		3	16.1	16.7	45
DSM0032G15	0.32	●		3	5.6	5.9	38	DSM0210G05	2.1	●		3	16.1	16.7	45
DSM0033G15	0.33	●		3	5.6	5.9	38	DSM0220G05	2.2	●		3	16.9	17.5	45
DSM0034G15	0.34	●		3	5.6	5.9	38	DSM0230G05	2.3	●		3	17.7	18.3	45
DSM0035G15	0.35	●		3	5.6	5.9	38	DSM0240G05	2.4	●		3	18.5	19.1	55
DSM0036G15	0.36	●		3	6.5	6.8	38	DSM0250G05	2.5	●		3	19.3	19.9	55
DSM0037G15	0.37	●		3	6.5	6.8	38	DSM0254G05	2.54	●		3	20.1	20.7	55
DSM0038G15	0.38	●		3	6.5	6.8	38	DSM0255G05	2.55	●		3	20.1	20.7	55
DSM0039G15	0.39	●		3	6.5	6.8	38	DSM0256G05	2.56	●		3	20.1	20.7	55
DSM0040G15	0.4	●		3	6.5	6.8	38	DSM0257G05	2.57	●		3	20.1	20.7	55
DSM0041G15	0.41	●		3	7.4	7.7	38	DSM0260G05	2.6	●		3	20.1	20.7	55
DSM0042G15	0.42	●		3	7.4	7.7	38	DSM0265G05	2.65	●		3	20.9	21.5	55
DSM0043G15	0.43	●		3	7.4	7.7	38	DSM0270G05	2.7	●		3	20.9	21.5	55
DSM0044G15	0.44	●		3	7.4	7.7	38	DSM0280G05	2.8	●		3	21.7	22.3	55
DSM0045G15	0.45	●		3	7.4	7.7	38	DSM0290G05	2.9	●		3	22.5	23.1	55
DSM0046G15	0.46	●		3	8.1	8.7	38	DSM0295G05	2.95	●		3	23.3	23.9	55
DSM0047G15	0.47	●		3	8.1	8.7	38	DSM0296G05	2.96	●		3	23.3	23.9	55
DSM0048G15	0.48	●		3	8.1	8.7	38	DSM0300G05	3	●		3	23.3	23.9	55
DSM0049G15	0.49	●		3	8.1	8.7	38								
DSM0050G15	0.5	●		3	8.1	8.7	38								
DSM0053G10	0.53	●		3	6.6	7.2	38								
DSM0055G10	0.55	●		3	6.6	7.2	38								
DSM0060G10	0.6	●		3	7.3	7.9	38								
DSM0061G10	0.61	●		3	7.9	8.5	38								
DSM0065G10	0.65	●		3	7.9	8.5	38								
DSM0070G10	0.7	●		3	8.6	9.2	38								
DSM0075G10	0.75	●		3	9.2	9.8	38								
DSM0080G10	0.8	●		3	9.9	10.5	38								
DSM0088G10	0.88	●		3	9.9	10.5	38								
DSM0090G10	0.9	●		3	9.9	10.5	38								
DSM0097G10	0.97	●		3	11	11.6	38								

● : Line up

STANDARD CUTTING CONDITIONS

ISO	Workpiece material	Hardness	Cutting speed: Vc (m/min)			Feed: f (mm/rev)				
			ø0.1 ~ ø0.3	ø0.3 ~ ø0.5	ø0.5 ~ ø3	ø0.1 ~ ø0.3	ø0.3 ~ ø0.5	ø0.5 ~ ø1	ø1 ~ ø2	ø2 ~ ø3
P	Carbon steels, Alloy steels	- 300 HB	5 - 20	15 - 30	25 - 60	0.001 - 0.004	0.002 - 0.01	0.005 - 0.05	0.03 - 0.09	0.05 - 0.1
M	Stainless steels	- 200 HB	2 - 12	6 - 18	10 - 20	0.0005 - 0.004	0.002 - 0.008	0.005 - 0.03	0.01 - 0.04	0.02 - 0.05
K	Grey cast irons	150 - 250 HB	5 - 15	10 - 25	20 - 50	0.0005 - 0.004	0.002 - 0.012	0.005 - 0.03	0.01 - 0.06	0.03 - 0.12
	Ductile cast irons	150 - 250 HB	5 - 15	10 - 25	20 - 50	0.001 - 0.003	0.002 - 0.01	0.005 - 0.02	0.01 - 0.05	0.03 - 0.1
N	Aluminium alloys	-	10 - 20	10 - 30	20 - 50	0.001 - 0.01	0.005 - 0.03	0.01 - 0.05	0.04 - 0.15	0.06 - 0.2
	Copper / Brass	-	10 - 20	10 - 30	20 - 50	0.001 - 0.01	0.005 - 0.03	0.01 - 0.05	0.04 - 0.15	0.06 - 0.2
S	Heat-resistant alloys	- 40 HRC	2 - 6	5 - 10	8 - 20	0.0005 - 0.003	0.002 - 0.004	0.002 - 0.004	0.002 - 0.004	※
H	High hardened steels	- 50 HRC	4 - 8	6 - 10	6 - 16	0.0005 - 0.002	0.001 - 0.005	0.005 - 0.02	0.01 - 0.03	0.02 - 0.06

※ Not recommended

Notes: • When the drilling depth is deeper than L/D = 5, use drill pecking every 10 to 50% of the drill diameter.

- The above cutting conditions are applied to when a water soluble cutting fluid is used. For drilling a hole smaller than ø0.3 mm, use of a starting drill is recommended.
- When setting the drill, the drill run out should be within 0.002 mm on the taper. (Especially for the drill diameter smaller than ø0.5 mm)

SOLIDDRILL DSM-CP

Centering drill for DSM drill

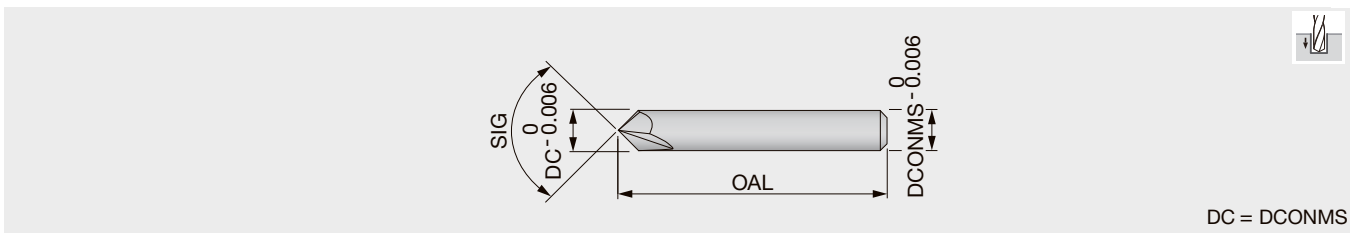

Designation	DC	YH170	DCONMS	OAL	SIG
DSM-CP90	3	●	3	38.1	90°
DSM-CP140	3	●	3	38.1	140°

● : Line up

STANDARD CUTTING CONDITIONS

ISO	Workpiece material	Hardness	Cutting speed: Vc (m/min)	Feed: f (mm/rev)	
				DSM-CP90	DSM-CP140
P	Carbon, Mild and Alloy steels	- 300 HB	30 - 80	0.01 - 0.06	0.03 - 0.08
M	Stainless steels	- 200 HB	15 - 40	0.01 - 0.03	0.02 - 0.06
K	Grey and ductile cast irons	150 - 250 HB	30 - 80	0.02 - 0.06	0.05 - 0.1
N	Aluminium alloys	-	60 - 120	0.02 - 0.1	0.05 - 0.15
H	High hardened steels	- 45 HRC	10 - 40	※	0.01 - 0.05

※ Not recommended

Notes: • For hard materials and stainless steels which have work-hardening nature, DSM-CP140 is recommended.

- Above cutting conditions are of using a water-soluble cutting fluid. When using a water-insoluble type, set the cutting speed to lower side.

Grade
Insert
Toolholder
Ext. Toolholder
Int. Toolholder
Threading
Grooving
Shaper
Endmill
Drilling Tool
Technical Reference

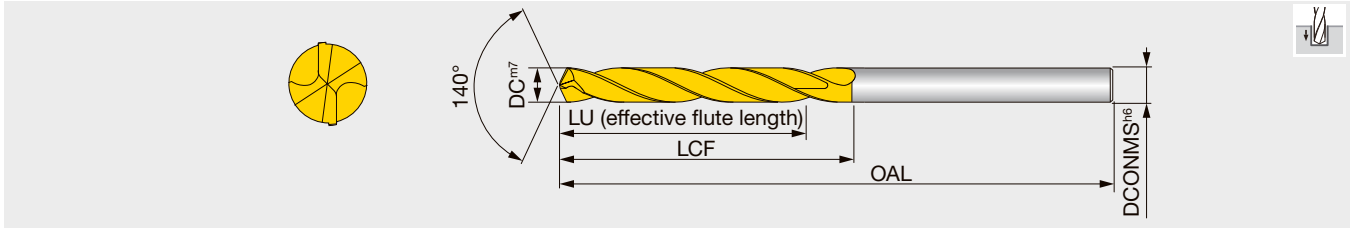

Designation	DC	AH725	DCONMS	LU	LCF	OAL	Designation	DC	AH725	DCONMS	LU	LCF	OAL
DSW030-014-06DE3	3	●	6	14	20	62	DSW076-029-08DE3	7.6	●	8	29	41	79
DSW031-014-06DE3	3.1	●	6	14	20	62	DSW077-029-08DE3	7.7	●	8	29	41	79
DSW032-014-06DE3	3.2	●	6	14	20	62	DSW078-029-08DE3	7.8	●	8	29	41	79
DSW033-014-06DE3	3.3	●	6	14	20	62	DSW079-029-08DE3	7.9	●	8	29	41	79
DSW034-014-06DE3	3.4	●	6	14	20	62	DSW080-029-08DE3	8	●	8	29	41	79
DSW035-014-06DE3	3.5	●	6	14	20	62	DSW081-035-10DE3	8.1	●	10	35	47	89
DSW036-014-06DE3	3.6	●	6	14	20	62	DSW082-035-10DE3	8.2	●	10	35	47	89
DSW037-014-06DE3	3.7	●	6	14	20	62	DSW083-035-10DE3	8.3	●	10	35	47	89
DSW038-017-06DE3	3.8	●	6	17	24	66	DSW084-035-10DE3	8.4	●	10	35	47	89
DSW039-017-06DE3	3.9	●	6	17	24	66	DSW085-035-10DE3	8.5	●	10	35	47	89
DSW040-017-06DE3	4	●	6	17	24	66	DSW086-035-10DE3	8.6	●	10	35	47	89
DSW041-017-06DE3	4.1	●	6	17	24	66	DSW087-035-10DE3	8.7	●	10	35	47	89
DSW042-017-06DE3	4.2	●	6	17	24	66	DSW088-035-10DE3	8.8	●	10	35	47	89
DSW043-017-06DE3	4.3	●	6	17	24	66	DSW089-035-10DE3	8.9	●	10	35	47	89
DSW044-017-06DE3	4.4	●	6	17	24	66	DSW090-035-10DE3	9	●	10	35	47	89
DSW045-017-06DE3	4.5	●	6	17	24	66	DSW091-035-10DE3	9.1	●	10	35	47	89
DSW046-017-06DE3	4.6	●	6	17	24	66	DSW092-035-10DE3	9.2	●	10	35	47	89
DSW047-017-06DE3	4.7	●	6	17	24	66	DSW093-035-10DE3	9.3	●	10	35	47	89
DSW048-020-06DE3	4.8	●	6	20	28	66	DSW094-035-10DE3	9.4	●	10	35	47	89
DSW049-020-06DE3	4.9	●	6	20	28	66	DSW095-035-10DE3	9.5	●	10	35	47	89
DSW050-020-06DE3	5	●	6	20	28	66	DSW096-035-10DE3	9.6	●	10	35	47	89
DSW051-020-06DE3	5.1	●	6	20	28	66	DSW097-035-10DE3	9.7	●	10	35	47	89
DSW052-020-06DE3	5.2	●	6	20	28	66	DSW098-035-10DE3	9.8	●	10	35	47	89
DSW053-020-06DE3	5.3	●	6	20	28	66	DSW099-035-10DE3	9.9	●	10	35	47	89
DSW054-020-06DE3	5.4	●	6	20	28	66	DSW100-035-10DE3	10	●	10	35	47	89
DSW055-020-06DE3	5.5	●	6	20	28	66	DSW101-040-12DE3	10.1	●	12	40	55	102
DSW056-020-06DE3	5.6	●	6	20	28	66	DSW102-040-12DE3	10.2	●	12	40	55	102
DSW057-020-06DE3	5.7	●	6	20	28	66	DSW103-040-12DE3	10.3	●	12	40	55	102
DSW058-020-06DE3	5.8	●	6	20	28	66	DSW104-040-12DE3	10.4	●	12	40	55	102
DSW059-020-06DE3	5.9	●	6	20	28	66	DSW105-040-12DE3	10.5	●	12	40	55	102
DSW060-020-06DE3	6	●	6	20	28	66	DSW106-040-12DE3	10.6	●	12	40	55	102
DSW061-024-08DE3	6.1	●	8	24	34	79	DSW107-040-12DE3	10.7	●	12	40	55	102
DSW062-024-08DE3	6.2	●	8	24	34	79	DSW108-040-12DE3	10.8	●	12	40	55	102
DSW063-024-08DE3	6.3	●	8	24	34	79	DSW109-040-12DE3	10.9	●	12	40	55	102
DSW064-024-08DE3	6.4	●	8	24	34	79	DSW110-040-12DE3	11	●	12	40	55	102
DSW065-024-08DE3	6.5	●	8	24	34	79	DSW111-040-12DE3	11.1	●	12	40	55	102
DSW066-024-08DE3	6.6	●	8	24	34	79	DSW112-040-12DE3	11.2	●	12	40	55	102
DSW067-024-08DE3	6.7	●	8	24	34	79	DSW113-040-12DE3	11.3	●	12	40	55	102
DSW068-024-08DE3	6.8	●	8	24	34	79	DSW114-040-12DE3	11.4	●	12	40	55	102
DSW069-024-08DE3	6.9	●	8	24	34	79	DSW115-040-12DE3	11.5	●	12	40	55	102
DSW070-024-08DE3	7	●	8	24	34	79	DSW116-040-12DE3	11.6	●	12	40	55	102
DSW071-029-08DE3	7.1	●	8	29	41	79	DSW117-040-12DE3	11.7	●	12	40	55	102
DSW072-029-08DE3	7.2	●	8	29	41	79	DSW118-040-12DE3	11.8	●	12	40	55	102
DSW073-029-08DE3	7.3	●	8	29	41	79	DSW119-040-12DE3	11.9	●	12	40	55	102
DSW074-029-08DE3	7.4	●	8	29	41	79	DSW120-040-12DE3	12	●	12	40	55	102
DSW075-029-08DE3	7.5	●	8	29	41	79							

● : Line up

STANDARD CUTTING CONDITIONS

See more information

e-catalog



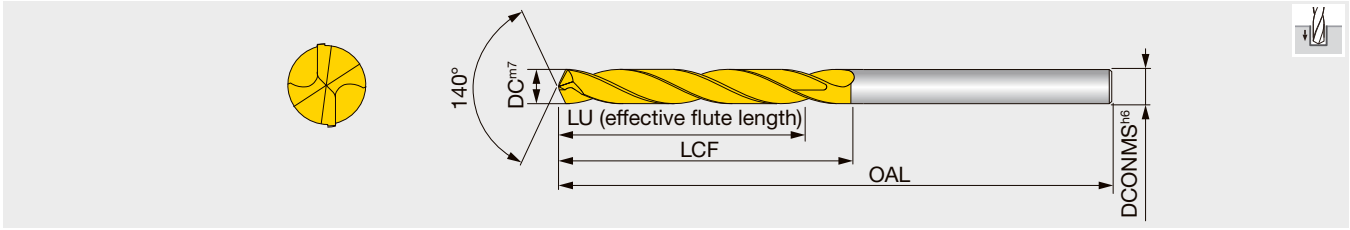

Designation	DC	AH725	DCONMS	LU	LCF	OAL	Designation	DC	AH725	DCONMS	LU	LCF	OAL
DSW030-023-06DE5	3	●	6	23	28	66	DSW076-043-08DE5	7.6	●	8	43	53	91
DSW031-023-06DE5	3.1	●	6	23	28	66	DSW077-043-08DE5	7.7	●	8	43	53	91
DSW032-023-06DE5	3.2	●	6	23	28	66	DSW078-043-08DE5	7.8	●	8	43	53	91
DSW033-023-06DE5	3.3	●	6	23	28	66	DSW079-043-08DE5	7.9	●	8	43	53	91
DSW034-023-06DE5	3.4	●	6	23	28	66	DSW080-043-08DE5	8	●	8	43	53	91
DSW035-023-06DE5	3.5	●	6	23	28	66	DSW081-049-10DE5	8.1	●	10	49	61	103
DSW036-023-06DE5	3.6	●	6	23	28	66	DSW082-049-10DE5	8.2	●	10	49	61	103
DSW037-023-06DE5	3.7	●	6	23	28	66	DSW083-049-10DE5	8.3	●	10	49	61	103
DSW038-029-06DE5	3.8	●	6	29	36	74	DSW084-049-10DE5	8.4	●	10	49	61	103
DSW039-029-06DE5	3.9	●	6	29	36	74	DSW085-049-10DE5	8.5	●	10	49	61	103
DSW040-029-06DE5	4	●	6	29	36	74	DSW086-049-10DE5	8.6	●	10	49	61	103
DSW041-029-06DE5	4.1	●	6	29	36	74	DSW087-049-10DE5	8.7	●	10	49	61	103
DSW042-029-06DE5	4.2	●	6	29	36	74	DSW088-049-10DE5	8.8	●	10	49	61	103
DSW043-029-06DE5	4.3	●	6	29	36	74	DSW089-049-10DE5	8.9	●	10	49	61	103
DSW044-029-06DE5	4.4	●	6	29	36	74	DSW090-049-10DE5	9	●	10	49	61	103
DSW045-029-06DE5	4.5	●	6	29	36	74	DSW091-049-10DE5	9.1	●	10	49	61	103
DSW046-029-06DE5	4.6	●	6	29	36	74	DSW092-049-10DE5	9.2	●	10	49	61	103
DSW047-029-06DE5	4.7	●	6	29	36	74	DSW093-049-10DE5	9.3	●	10	49	61	103
DSW048-035-06DE5	4.8	●	6	35	44	82	DSW094-049-10DE5	9.4	●	10	49	61	103
DSW049-035-06DE5	4.9	●	6	35	44	82	DSW095-049-10DE5	9.5	●	10	49	61	103
DSW050-035-06DE5	5	●	6	35	44	82	DSW096-049-10DE5	9.6	●	10	49	61	103
DSW051-035-06DE5	5.1	●	6	35	44	82	DSW097-049-10DE5	9.7	●	10	49	61	103
DSW052-035-06DE5	5.2	●	6	35	44	82	DSW098-049-10DE5	9.8	●	10	49	61	103
DSW053-035-06DE5	5.3	●	6	35	44	82	DSW099-049-10DE5	9.9	●	10	49	61	103
DSW054-035-06DE5	5.4	●	6	35	44	82	DSW100-049-10DE5	10	●	10	49	61	103
DSW055-035-06DE5	5.5	●	6	35	44	82	DSW101-056-12DE5	10.1	●	12	56	71	118
DSW056-035-06DE5	5.6	●	6	35	44	82	DSW102-056-12DE5	10.2	●	12	56	71	118
DSW057-035-06DE5	5.7	●	6	35	44	82	DSW103-056-12DE5	10.3	●	12	56	71	118
DSW058-035-06DE5	5.8	●	6	35	44	82	DSW104-056-12DE5	10.4	●	12	56	71	118
DSW059-035-06DE5	5.9	●	6	35	44	82	DSW105-056-12DE5	10.5	●	12	56	71	118
DSW060-035-06DE5	6	●	6	35	44	82	DSW106-056-12DE5	10.6	●	12	56	71	118
DSW061-043-08DE5	6.1	●	8	43	53	91	DSW107-056-12DE5	10.7	●	12	56	71	118
DSW062-043-08DE5	6.2	●	8	43	53	91	DSW108-056-12DE5	10.8	●	12	56	71	118
DSW063-043-08DE5	6.3	●	8	43	53	91	DSW109-056-12DE5	10.9	●	12	56	71	118
DSW064-043-08DE5	6.4	●	8	43	53	91	DSW110-056-12DE5	11	●	12	56	71	118
DSW065-043-08DE5	6.5	●	8	43	53	91	DSW111-056-12DE5	11.1	●	12	56	71	118
DSW066-043-08DE5	6.6	●	8	43	53	91	DSW112-056-12DE5	11.2	●	12	56	71	118
DSW067-043-08DE5	6.7	●	8	43	53	91	DSW113-056-12DE5	11.3	●	12	56	71	118
DSW068-043-08DE5	6.8	●	8	43	53	91	DSW114-056-12DE5	11.4	●	12	56	71	118
DSW069-043-08DE5	6.9	●	8	43	53	91	DSW115-056-12DE5	11.5	●	12	56	71	118
DSW070-043-08DE5	7	●	8	43	53	91	DSW116-056-12DE5	11.6	●	12	56	71	118
DSW071-043-08DE5	7.1	●	8	43	53	91	DSW117-056-12DE5	11.7	●	12	56	71	118
DSW072-043-08DE5	7.2	●	8	43	53	91	DSW118-056-12DE5	11.8	●	12	56	71	118
DSW073-043-08DE5	7.3	●	8	43	53	91	DSW119-056-12DE5	11.9	●	12	56	71	118
DSW074-043-08DE5	7.4	●	8	43	53	91	DSW120-056-12DE5	12	●	12	56	71	118
DSW075-043-08DE5	7.5	●	8	43	53	91							

● : Line up

STANDARD CUTTING CONDITIONS

See more information

e-catalog



DSW-DI5

Solid drill, L/D = 5, DIN shank, with coolant hole

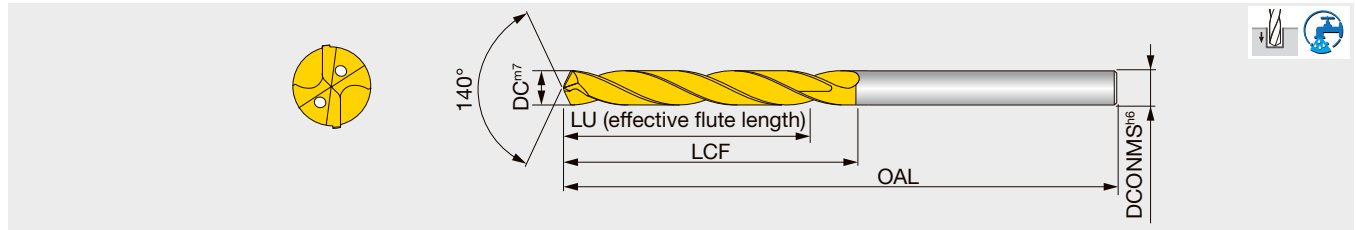

Designation	DC	AH725	DCONMS	LU	LCF	OAL	Designation	DC	AH725	DCONMS	LU	LCF	OAL
DSW030-023-06DI5	3	●	6	23	28	66	DSW076-043-08DI5	7.6	●	8	43	53	91
DSW031-023-06DI5	3.1	●	6	23	28	66	DSW077-043-08DI5	7.7	●	8	43	53	91
DSW032-023-06DI5	3.2	●	6	23	28	66	DSW078-043-08DI5	7.8	●	8	43	53	91
DSW033-023-06DI5	3.3	●	6	23	28	66	DSW079-043-08DI5	7.9	●	8	43	53	91
DSW034-023-06DI5	3.4	●	6	23	28	66	DSW080-043-08DI5	8	●	8	43	53	91
DSW035-023-06DI5	3.5	●	6	23	28	66	DSW081-049-10DI5	8.1	●	10	49	61	103
DSW036-023-06DI5	3.6	●	6	23	28	66	DSW082-049-10DI5	8.2	●	10	49	61	103
DSW037-023-06DI5	3.7	●	6	23	28	66	DSW083-049-10DI5	8.3	●	10	49	61	103
DSW038-029-06DI5	3.8	●	6	29	36	74	DSW084-049-10DI5	8.4	●	10	49	61	103
DSW039-029-06DI5	3.9	●	6	29	36	74	DSW085-049-10DI5	8.5	●	10	49	61	103
DSW040-029-06DI5	4	●	6	29	36	74	DSW086-049-10DI5	8.6	●	10	49	61	103
DSW041-029-06DI5	4.1	●	6	29	36	74	DSW087-049-10DI5	8.7	●	10	49	61	103
DSW042-029-06DI5	4.2	●	6	29	36	74	DSW088-049-10DI5	8.8	●	10	49	61	103
DSW043-029-06DI5	4.3	●	6	29	36	74	DSW089-049-10DI5	8.9	●	10	49	61	103
DSW044-029-06DI5	4.4	●	6	29	36	74	DSW090-049-10DI5	9	●	10	49	61	103
DSW045-029-06DI5	4.5	●	6	29	36	74	DSW091-049-10DI5	9.1	●	10	49	61	103
DSW046-029-06DI5	4.6	●	6	29	36	74	DSW092-049-10DI5	9.2	●	10	49	61	103
DSW047-029-06DI5	4.7	●	6	29	36	74	DSW093-049-10DI5	9.3	●	10	49	61	103
DSW048-035-06DI5	4.8	●	6	35	44	82	DSW094-049-10DI5	9.4	●	10	49	61	103
DSW049-035-06DI5	4.9	●	6	35	44	82	DSW095-049-10DI5	9.5	●	10	49	61	103
DSW050-035-06DI5	5	●	6	35	44	82	DSW096-049-10DI5	9.6	●	10	49	61	103
DSW051-035-06DI5	5.1	●	6	35	44	82	DSW097-049-10DI5	9.7	●	10	49	61	103
DSW052-035-06DI5	5.2	●	6	35	44	82	DSW098-049-10DI5	9.8	●	10	49	61	103
DSW053-035-06DI5	5.3	●	6	35	44	82	DSW099-049-10DI5	9.9	●	10	49	61	103
DSW054-035-06DI5	5.4	●	6	35	44	82	DSW100-049-10DI5	10	●	10	49	61	103
DSW055-035-06DI5	5.5	●	6	35	44	82	DSW101-056-12DI5	10.1	●	12	56	71	118
DSW056-035-06DI5	5.6	●	6	35	44	82	DSW102-056-12DI5	10.2	●	12	56	71	118
DSW057-035-06DI5	5.7	●	6	35	44	82	DSW103-056-12DI5	10.3	●	12	56	71	118
DSW058-035-06DI5	5.8	●	6	35	44	82	DSW104-056-12DI5	10.4	●	12	56	71	118
DSW059-035-06DI5	5.9	●	6	35	44	82	DSW105-056-12DI5	10.5	●	12	56	71	118
DSW060-035-06DI5	6	●	6	35	44	82	DSW106-056-12DI5	10.6	●	12	56	71	118
DSW061-043-08DI5	6.1	●	8	43	53	91	DSW107-056-12DI5	10.7	●	12	56	71	118
DSW062-043-08DI5	6.2	●	8	43	53	91	DSW108-056-12DI5	10.8	●	12	56	71	118
DSW063-043-08DI5	6.3	●	8	43	53	91	DSW109-056-12DI5	10.9	●	12	56	71	118
DSW064-043-08DI5	6.4	●	8	43	53	91	DSW110-056-12DI5	11	●	12	56	71	118
DSW065-043-08DI5	6.5	●	8	43	53	91	DSW111-056-12DI5	11.1	●	12	56	71	118
DSW066-043-08DI5	6.6	●	8	43	53	91	DSW112-056-12DI5	11.2	●	12	56	71	118
DSW067-043-08DI5	6.7	●	8	43	53	91	DSW113-056-12DI5	11.3	●	12	56	71	118
DSW068-043-08DI5	6.8	●	8	43	53	91	DSW114-056-12DI5	11.4	●	12	56	71	118
DSW069-043-08DI5	6.9	●	8	43	53	91	DSW115-056-12DI5	11.5	●	12	56	71	118
DSW070-043-08DI5	7	●	8	43	53	91	DSW116-056-12DI5	11.6	●	12	56	71	118
DSW071-043-08DI5	7.1	●	8	43	53	91	DSW117-056-12DI5	11.7	●	12	56	71	118
DSW072-043-08DI5	7.2	●	8	43	53	91	DSW118-056-12DI5	11.8	●	12	56	71	118
DSW073-043-08DI5	7.3	●	8	43	53	91	DSW119-056-12DI5	11.9	●	12	56	71	118
DSW074-043-08DI5	7.4	●	8	43	53	91	DSW120-056-12DI5	12	●	12	56	71	118
DSW075-043-08DI5	7.5	●	8	43	53	91							

● : Line up

STANDARD CUTTING CONDITIONS

See more information

e-catalog



Recommended coolant pressure and volume for internal coolant supply:

The following graph is a reference guide for pressure and volume. Values should be adjusted according to work material and actual chip evacuation.

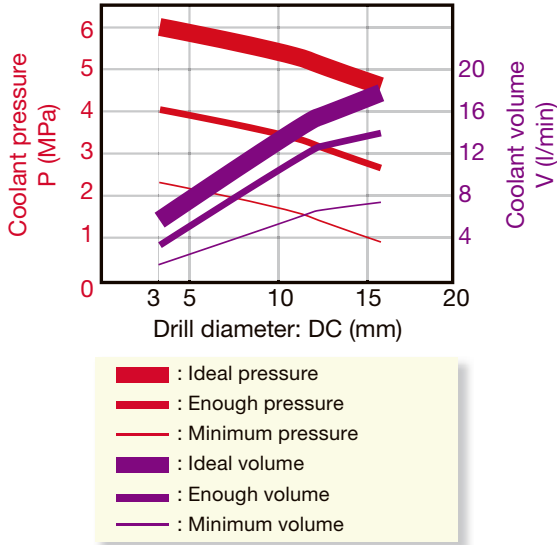

Reference for required spindle power:

The required spindle power may vary depending on the type of work material or hardness. A spindle with sufficient power should be used when referring to the below graph.

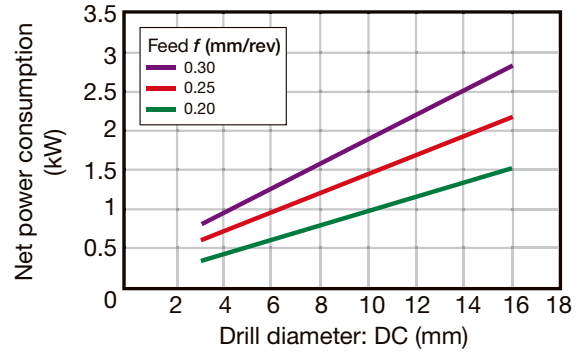

Work material : Alloy steel (SNCM439)
Cutting speed : $V_c = 100$ m/min

Grade

Insert

Ext. Toolholder

Int. Toolholder

Threading

Grooving

Shaper

Endmill

Drilling Tool

Technical Reference

TUNGDRILL TWISTED

TDX-F L/D=2

Indexable drill, L/D = 2, flat cotter

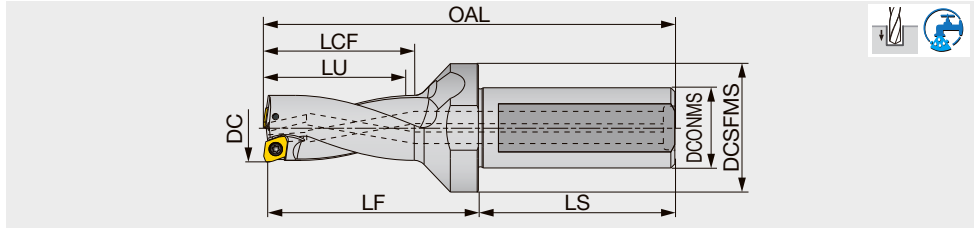

Designation	DC	DCONMS	DCSFMS	LU	LS	LCF	LF	OAL	Max. offset (radial)	WT(kg)	Insert
TDX125F20-2	12.5	20	25	25.4	49	28.4	41	90.4	0.8	0.2	XPMT040104R-D*
TDX130F20-2	13	20	25	26.4	49	29.4	42	91.4	0.7	0.2	XPMT040104R-D*
TDX135F20-2	13.5	20	25	27.4	49	30.4	43	92.4	0.6	0.2	XPMT040104R-D*
TDX140F20-2	14	20	25	28.4	49	31.4	44	93.4	0.5	0.2	XPMT040104R-D*
TDX145F20-2	14.5	20	25	29.4	49	32.4	46	95.4	0.4	0.2	XPMT040104R-D*
TDX150F20-2	15	20	25	30.5	49	33.5	47	96.5	0.9	0.2	XPMT050204R-D*
TDX155F20-2	15.5	20	32	31.5	49	34.5	49	98.5	0.8	0.2	XPMT050204R-D*
TDX160F20-2	16	20	32	32.5	49	35.5	51	100.5	0.6	0.2	XPMT050204R-D*
TDX165F20-2	16.5	20	32	33.5	49	36.5	52	101.5	0.5	0.2	XPMT050204R-D*
TDX170F20-2	17	20	32	34.5	49	37.5	53	102.5	0.4	0.2	XPMT050204R-D*
TDX175F25-2	17.5	25	32	35.5	54	38.5	55	109.5	1.2	0.3	XPMT06X308R-D*
TDX180F25-2	18	25	32	36.5	54	39.5	56	110.5	1.1	0.3	XPMT06X308R-D*
TDX185F25-2	18.5	25	32	37.5	54	40.5	57	111.5	0.9	0.3	XPMT06X308R-D*
TDX190F25-2	19	25	32	38.5	54	41.5	58	112.5	0.8	0.3	XPMT06X308R-D*
TDX195F25-2	19.5	25	32	39.5	54	42.5	60	114.5	0.7	0.3	XPMT06X308R-D*
TDX200F25-2	20	25	32	40.5	54	45.5	61	115.5	0.5	0.3	XPMT06X308R-D*

Tool diameter	Tool diameter tolerance	Hole diameter tolerance*
ø12.5 - ø17	+ 0.1 / 0	+ 0.25 / 0
ø17.5 - ø20	+ 0.2 / 0	+ 0.3 / 0

*Just for reference

SPARE PARTS



Designation	Clamping screw	Wrench
TDX125 - 145	CSPB-2H	IP-6DB
TDX150 - 170	CSPB-2L043	IP-6DB
TDX175 -200	CSPB-2.2	IP-7D

Recommended clamping torque (N·m): CSPB-2H/CSPB-2L043=0.7, CSPB-2.2=1

TUNGDRILLTWISTED

TDX-F L/D=3

Indexable drill, L/D = 3, flat cotter

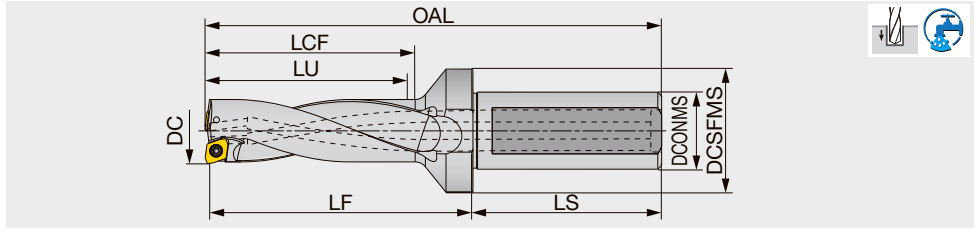

Designation	DC	DCONMS	DCSFMS	LU	LS	LCF	LF	OAL	Max. offset (radial)	WT(kg)	Insert
TDX125F20-3	12.5	20	25	37.9	49	40.9	53	102.4	0.8	0.2	XPMT040104R-D*
TDX130F20-3	13	20	25	39.4	49	42.4	55	104.4	0.7	0.2	XPMT040104R-D*
TDX135F20-3	13.5	20	25	40.9	49	43.9	56	105.4	0.6	0.2	XPMT040104R-D*
TDX140F20-3	14	20	25	42.4	49	45.4	58	107.4	0.5	0.2	XPMT040104R-D*
TDX145F20-3	14.5	20	25	43.9	49	46.9	60	109.4	0.4	0.2	XPMT040104R-D*
TDX150F20-3	15	20	25	45.4	49	48.4	62	111.4	0.9	0.2	XPMT050204R-D*
TDX155F20-3	15.5	20	32	46.9	49	49.9	64	113.4	0.8	0.2	XPMT050204R-D*
TDX160F20-3	16	20	32	48.4	49	51.4	66	115.4	0.6	0.2	XPMT050204R-D*
TDX165F20-3	16.5	20	32	49.9	49	52.9	68	117.4	0.5	0.2	XPMT050204R-D*
TDX170F20-3	17	20	32	51.4	49	54.4	69	118.4	0.4	0.2	XPMT050204R-D*
TDX175F25-3	17.5	25	32	53	54	56	72	126.5	1.2	0.3	XPMT06X308R-D*
TDX180F25-3	18	25	32	54.5	54	57.5	73	127.5	1.1	0.3	XPMT06X308R-D*
TDX185F25-3	18.5	25	32	56	54	59	75	129.5	0.9	0.3	XPMT06X308R-D*
TDX190F25-3	19	25	32	57.5	54	60.5	76	130.5	0.8	0.3	XPMT06X308R-D*
TDX195F25-3	19.5	25	32	59	54	62	79	133.5	0.7	0.3	XPMT06X308R-D*
TDX200F25-3	20	25	32	60.5	54	65.5	81	135.5	0.5	0.3	XPMT06X308R-D*

Tool diameter	Tool diameter tolerance	Hole diameter tolerance*
ø12.5 - ø17	+ 0.1 / 0	+ 0.25 / 0
ø17.5 - ø20	+ 0.2 / 0	+ 0.3 / 0

*Just for reference

SPARE PARTS



Designation	Clamping screw	Wrench
TDX125 - 145	CSPB-2H	IP-6DB
TDX150 - 170	CSPB-2L043	IP-6DB
TDX175 - 200	CSPB-2.2	IP-7D

Recommended clamping torque (N·m): CSPB-2H/CSPB-2L043=0.7, CSPB-2.2=1

Reference pages: Inserts → 9-30 - 9-30
Standard cutting conditions → 9-31

Grade
Insert
Ext. Toolholder
Int. Toolholder
Threading
Grooving
Shaper
Endmill
Drilling Tool
Technical Reference

INSERT

DJ

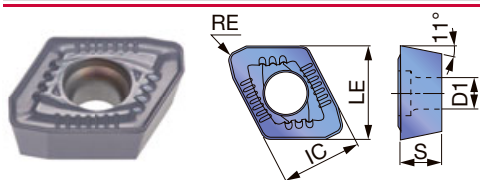

P	Steel		★	☆					
M	Stainless	☆	★						
K	Cast iron		☆	☆	★				
N	Non-ferrous	★		☆					
S	Superalloys	☆	★	☆					
H	Hard materials	☆	★	☆					

★ : First choice
☆ : Second choice

Designation	IC	LE	Coated				S	D1	RE	DCN	DCX
			AH725	T1115	AH6030	AH9030					
XPMT040104R-DJ	4.3	4.5	●	●	●	●	1.59	2.3	0.4	12.5	14.5
XPMT050204R-DJ	5.2	5.4	●	●	●	●	2.38	2.3	0.4	15	17
XPMT06X308R-DJ	6	7	●	●	●	●	3	2.5	0.8	17.5	21.5

● : Line up

DS

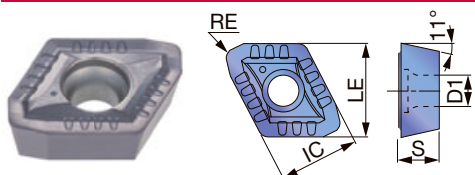

P	Steel	☆	★						
M	Stainless	☆	★						
K	Cast iron								
N	Non-ferrous	☆							
S	Superalloys	☆	★						
H	Hard materials								

★ : First choice
☆ : Second choice

Designation	IC	LE	Coated				S	D1	RE	DCN	DCX
			AH725	AH6030							
XPMT040104R-DS	4.3	4.5	●	●			1.59	2.3	0.4	12.5	14.5
XPMT050204R-DS	5.2	5.4	●	●			2.38	2.3	0.4	15	17
XPMT06X308R-DS	6	7	●	●			3	2.5	0.8	17.5	21.5

● : Line up

DW

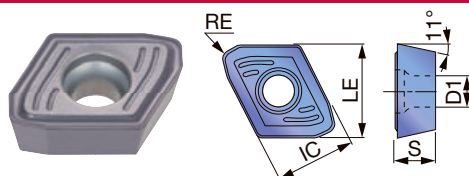

P	Steel	☆	★	☆					
M	Stainless	☆	★	☆					
K	Cast iron		☆	★					
N	Non-ferrous	☆	★						
S	Superalloys	☆	★	☆					
H	Hard materials	☆	★	☆					

★ : First choice
☆ : Second choice

Designation	IC	LE	Coated				S	D1	RE	DCN	DCX
			AH725	AH6030	AH9030						
XPMT040104R-DW	4.3	4.5	●	●	●		1.59	2.3	0.4	12.5	14.5
XPMT050204R-DW	5.2	5.4	●	●	●		2.38	2.3	0.4	15	17
XPMT06X308R-DW	6	7	●	●	●		3	2.5	0.8	17.5	21.5

● : Line up

RECOMMENDED INSERT

ISO	Workpiece material	Hardness	First choice	High feed	High speed	Troubleshooting		
						Chipping resistance	Wear resistance	Surface finish
P	Low carbon steels (C ≤ 0.3%)	- 200 HB	DS, AH6030	-	-	DS, AH725	-	DW, AH6030
	Carbon steels (C > 0.3%) Alloy steels	- 300 HB	DJ, AH6030	DW, AH6030	DJ, AH9030	DW, AH725	DJ, AH9030	DW, AH6030
	Low alloy steels	- 200 HB	DS, AH6030	-	-	DS, AH725	-	DW, AH6030
M	Stainless steel	- 200 HB	DS, AH6030	-	-	DS, AH725	-	DW, AH6030
K	Grey cast irons	150 - 250 HB	DJ, AH9030	DW, AH9030	DJ, T1115	DW, AH725	-	DW, AH9030
	Ductile cast irons	150 - 250 HB	DJ, AH9030	DW, AH9030	-	DW, AH725	-	DW, AH9030
N	Aluminium alloy	-	DJ, AH725	DW, AH725	DS, AH6030	-	-	DW, AH725
S	Titanium alloys Heat-resistant alloys	- 40 HRC	DS, AH6030	-	-	DW, AH725	-	DW, AH725
H	Hardened steel	- 50 HRC	DJ, AH9030	DW, AH9030	-	DW, AH725	-	DW, AH9030

STANDARD CUTTING CONDITIONS

ISO	Workpiece material	Hardness	Cutting speed Vc (m/min)	Series L/D	Feed: f (mm/rev)		
					ø12.5 ~ ø14.5	ø15 ~ ø17	ø17.5 ~ ø26
P	Low carbon steels (C < 0.3) SS400, SM490, S25C, etc. st42-1, St52-3, C25, etc.	- 200 HB	160 - 320	2D, 3D	0.02 - 0.06	0.02 - 0.06	0.04 - 0.1
	Carbon steels (C > 0.3) S45C, S55C, etc. C45, C55, etc.	- 300 HB	80 - 250	2D, 3D	0.04 - 0.1	0.04 - 0.12	0.06 - 0.13
	Low alloy steels SCM415, etc.	- 200 HB	160 - 250	2D, 3D	0.04 - 0.08	0.04 - 0.08	0.06 - 0.12
M	Alloy steels SCM440, SCr420, etc. 42CrMo4, 20Cr4, etc.	- 300 HB	80 - 200	2D, 3D	0.04 - 0.1	0.04 - 0.12	0.06 - 0.13
	Stainless steels (Austenitic) SUS304, SUS316, etc. X5CrNi18-9, X5CrNiMo17-12-2, etc.	- 200 HB	100 - 200	2D, 3D	0.02 - 0.08	0.02 - 0.08	0.04 - 0.1
	Stainless steels (Martensitic and ferritic) SUS430, SUS416, etc. X6Cr17, X20Cr13, etc.	- 200 HB	100 - 220	2D, 3D	0.02 - 0.08	0.02 - 0.08	0.04 - 0.1
	Stainless steels (Precipitation hardening) SUS630, etc. X5CrNiCuNb16-4, etc.	-	80 - 120	2D, 3D	0.04 - 0.08	0.04 - 0.08	0.04 - 0.08
K	Grey cast irons FC250, etc., 250, etc.	150 - 250 HB	80 - 250	2D, 3D	0.06 - 0.12	0.06 - 0.12	0.06 - 0.15
	Ductile cast irons FCD700, etc., 600-3, etc.	150 - 250 HB	80 - 200	2D, 3D	0.04 - 0.12	0.04 - 0.12	0.06 - 0.15
N	Aluminium alloy A2017, ADC12, etc. AlCu4SiMg, AlSi11Cu3, etc.	-	200 - 400	2D, 3D	0.1 - 0.12	0.1 - 0.15	0.15 - 0.2
S	Heat-resistant alloys Inconel 718, etc.	- 40 HRC	20 - 60	2D, 3D	0.04 - 0.08	0.04 - 0.08	0.04 - 0.1
	Titanium alloys Ti-6Al-4V, etc.	- 40 HRC	40 - 120	2D, 3D	0.06 - 0.1	0.06 - 0.1	0.06 - 0.12
H	Hardened steel	- 50 HRC	40 - 100	2D, 3D	0.04 - 0.08	0.04 - 0.08	0.04 - 0.1

Grade 1
Insert 2
Ext. Toolholder 3
Int. Toolholder 4
Threading 5
Grooving 6
Shaper 7
Endmill 8
Drilling Tool 9
Technical Reference 10

Technical Reference

The background of the image is a blurred technical drawing on a white sheet of paper. In the lower-left corner, a detailed drawing of a gear is visible. In the lower-right corner, a red-handled screwdriver is lying on the paper. The overall scene is a close-up, shallow depth-of-field shot of a workspace.

Technical Reference

Tungaloy, NTK

For instructions, directions and parts,
please refer to the General catalog



Tungaloy



NTK

NTK

SPLASH holders



NTK

Y-axis turning holder, please refer to page : O24



Grade

1

Insert

2

Ext. Toolholder

3

Int. Toolholder

4

Threading

5

Grooving

6

Shaper

7

Endmill

8

Drilling Tool

9

Technical Reference

10

MEMO

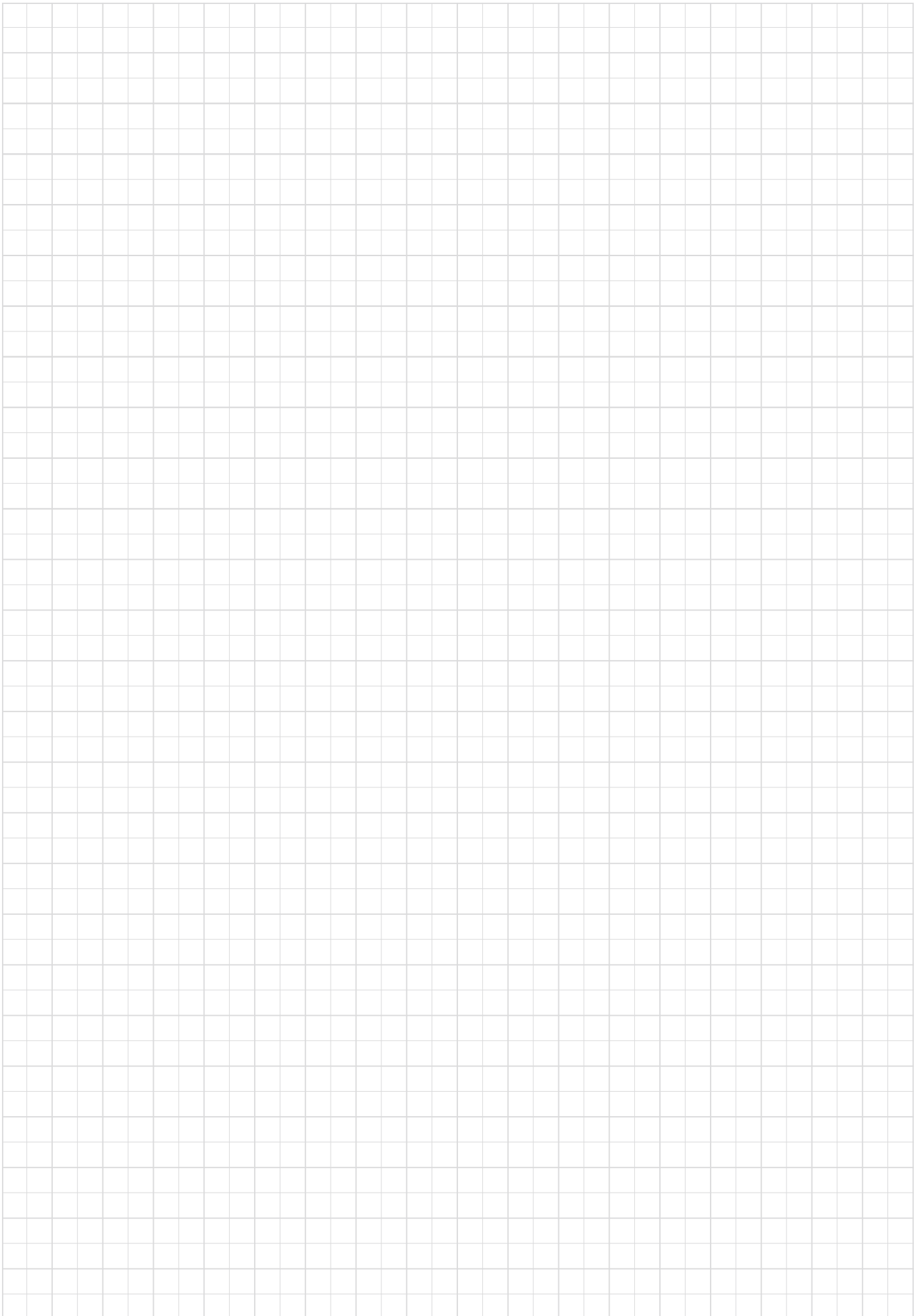

MEMO

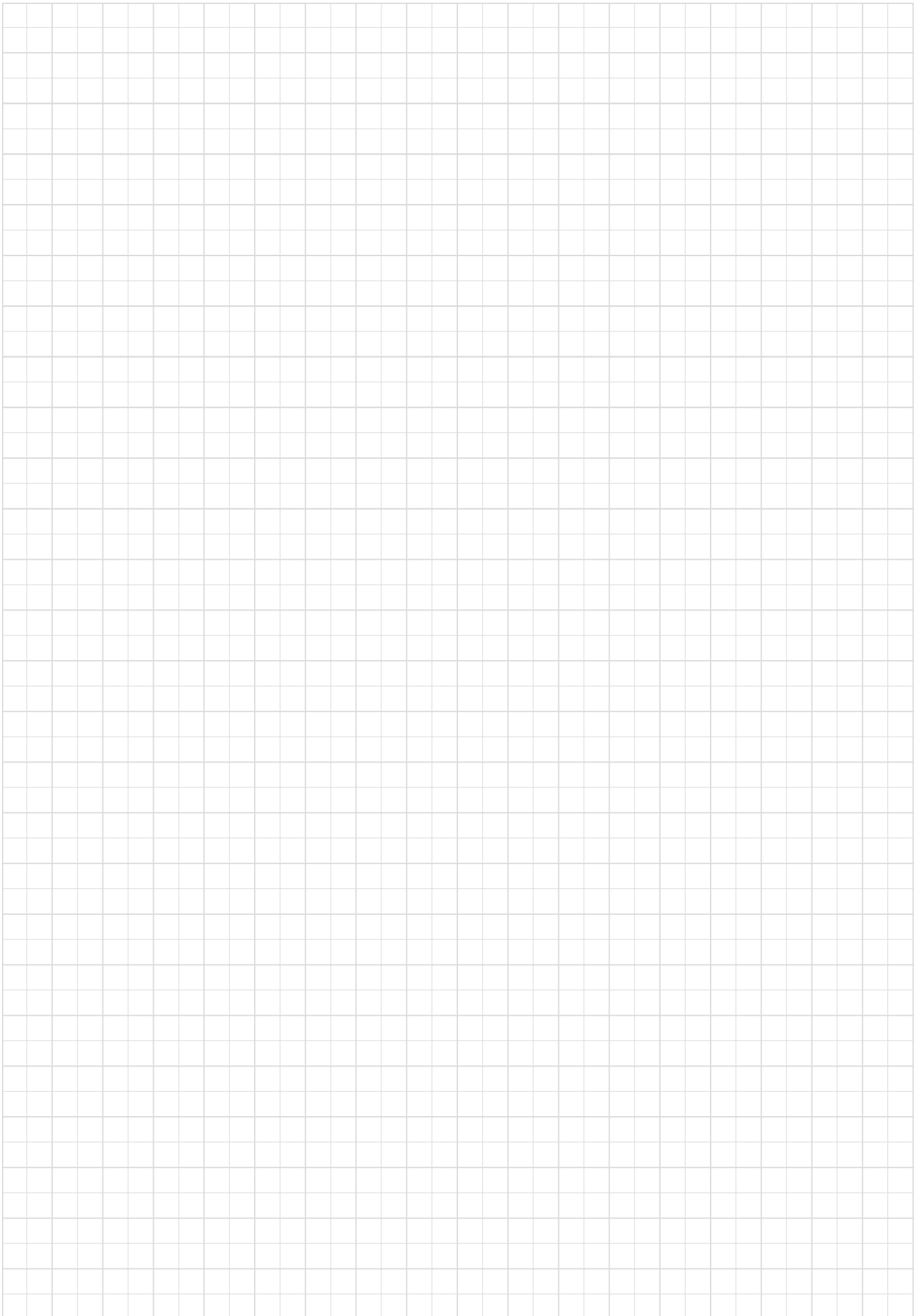

Worldwide Network

Head Office & Production
Facilities in Japan

Tungaloy Corporation Head Office

11-1 Yoshima Kogyodanchi
Iwaki 970-1144 Japan
Phone: +81-246-36-8501
Fax: +81-246-36-8542
www.tungaloy.com

Iwaki Plant

Products: Cutting Tools

Nagoya Plant

Products: Cutting Tools

Kyushu Plant

Products: PCBN
PCD Tools
Deep Hole Drills

Nirasaki Plant

Products: Cutting Tools
Friction Materials (TungFric)
Wear Resistant Tools
Civil Engineering Tools

NTK CUTTING TOOLS Co., Ltd.

Head Office

2808 Iwasaki Komaki City, Aichi
Prefecture, 485-8510 Japan
Phone: +81-568-76-1270
www.ntkcuttingtools.com/jp-en

Komaki plant

Products: Cutting Tools

Kamioka plant

Products: Cutting Tools

Sales Channels

Tungaloy-NTK America, Inc.

3726 N. Ventura Drive
Arlington Heights
IL 60004, U.S.A.
Phone: +1-888-554-8394
Fax: +1-888-554-8392
www.tungaloy.com/us
<https://www.ntkcuttingtools.com/us/>

Tungaloy Canada

432 Elgin St. Unit 3, Brantford
Ontario N3S 7P7, Canada
Phone: +1-519-758-5779
Fax: +1-519-758-5791
www.tungaloy.com/ca

Tungaloy-NTK de Mexico S.A.

C/ Los Arellano 113
Parque Industrial Siglo XXI
Aguascalientes, AGS
Mexico 20290
Phone: +52-449-929-5410
Fax: +52-449-929-5411
www.tungaloy.com/mx
<https://www.ntkcuttingtools.com/mx/>

Tungaloy-NTK do Brasil Ltda.

Avd. Independencia N4158
Residencial Flora
13280-000 Vinhedo
São Paulo, Brazil
Phone: +55-19-38262757
Fax: +55-19-38262757
www.tungaloy.com/br
<https://www.ntkcuttingtools.com/br/>

Tungaloy-NTK Germany GmbH

Katzbergstr. 3a
D-40764 Langenfeld, Germany
Phone: +49-2173-90420-0
Fax: +49-2173-90420-19
www.tungaloy.com/de
<https://www.ntkcuttingtools.com/de/>

Tungaloy France S.A.S.

ZA Courtaboeuf - Le Rio
1 rue de la Terre de feu
F-91952 Courtaboeuf Cedex, France
Phone: +33-1-6486-4300
Fax: +33-1-6907-7817
www.tungaloy.com/fr

Tungaloy Italia S.r.l.

Via E. Andolfato 10
I-20126 Milano, Italy
Phone: +39-02-252012-1
Fax: +39-02-252012-65
www.tungaloy.com/it

Tungaloy Czech s.r.o.

Turanka 115
CZ-627 00 Brno, Czech Republic
Phone: +420-532 123 391
Fax: +420-532 123 392
www.tungaloy.com/cz

Tungaloy Ibérica S.L.

C/Miquel Servet, 43B, Nau 7
Pol. Ind. Bufalvent
ES-08243 Manresa (BCN), Spain
Phone: +34 93 113 1360
Fax: +34 93 876 2798
www.tungaloy.com/es

Tungaloy Scandinavia AB

Bultgatan 38, 442 40
Kungälv, Sweden
Phone: +46-462119200
Fax: +46-462119207
www.tungaloy.com/se

Tungaloy Rus, LLC

Andropova avenue, h.18/7,
11 floor, office 3, 115432,
Moscow, Russia
Phone: +7-499-683-01-80
Fax: +7-499-683-01-81
www.tungaloy.com/ru

Tungaloy Polska Sp. z o.o.

Ul. Irysowa 1, 55-040 Bielany
Wrocławskie, Poland
Phone: +48 607 907 237
www.tungaloy.com/pl

Tungaloy-NTK U.K. Ltd

Gallan Park, Watling Street,
Cannock, WS110XG, UK
Phone: +44 121 4000 231
Fax: +44 121 270 9694
www.tungaloy.com/uk
<https://www.ntkcuttingtools.com/uk/>

Tungaloy Hungary Kft

Erzsébet királyné útja 125
H-1142 Budapest, Hungary
Phone: +36 1 781-6846
Fax: +36 1 781-6866
www.tungaloy.com/hu

Tungaloy Turkey

Serifali Mah.bayraktar
Bulvari Kule Sk. No:26
34775 Umraniye / Istanbul / Turkey
Phone: +90 216 540 04 67
Fax: +90 216 540 04 87
www.tungaloy.com/tr

Tungaloy Benelux b.v.

Tjalk 70
NL-2411 NZ Bodegraven Netherlands
Phone: +31 172 630 420
Fax: +31 172 630 429
www.tungaloy.com/nl

Tungaloy Croatia

Ulica bana Josipa Jelačića 87,
10430 Samobor, Croatia
Phone: +385 1 3326 604
Fax: +385 1 3327 683
www.tungaloy.com/hr

Tungaloy Cutting Tool (Shanghai) Co.,Ltd.

Rm No 401 No.88 Zhabei
Jiangchang No.3 Rd
Shanghai 200436, China
Phone: +86-21-3632-1880
Fax: +86-21-3621-1918
www.tungaloy.com/cn

Tungaloy-NTK Cutting Tools

(Thailand) Co.,Ltd.

Interlink tower 4th Fl.
1858/5-7 Bangna-Trad Road
km.5 Bangna, Bangna, Bangkok
10260
Thailand
Phone: +66-2-751-5711
Fax: +66-2-751-5715
www.tungaloy.com/th
https://www.ntkcuttingtools.com/th/

Tungaloy Cutting Tools (Taiwan) Co.,Ltd.

9F. No.293, Zhongyuan St,
Xinzhuang Dist, New Taipei City,
24251 Taiwan
Phone: +886-2-8521-9986
Fax: +886-2-8521-8935
www.tungaloy.com/tw

Tungaloy Singapore (Pte.), Ltd.

62 Ubi Road 1
#06-11 Oxley BizHub 2
Singapore 408734
Phone: +65-6391-1833
Fax: +65-6299-4557
www.tungaloy.com/sg

Tungaloy Vietnam

LE 04-38, Lexington Residence
67 Mai Chi Tho, Dist. 2,
Ho Chi Minh City, Vietnam
Phone: +84-2837406660
www.tungaloy.com/sg

Tungaloy India Pvt. Ltd.

One International Center,
Unit # 902-A, 9th Floor,
Tower 1, Senapati Bapat Marg,
Elphinstone Road (West),
Mumbai -400013, India
Phone: +91-22-6124-8804
Fax: +91-22-6124-8899
www.tungaloy.com/in

Tungaloy Korea Co., Ltd

#1312, Byucksan Digital Valley 5-cha
Beotkkot-ro 244, Geumcheon-gu
153-788 Seoul, Korea
Phone: +82-2-2621-6161
Fax: +82-2-6393-8952
www.tungaloy.com/kr

Tungaloy Malaysia Sdn Bhd

50 K-2, Kelana Mall, Jalan
SS6/14, Kelana Jaya, 47301
Petaling Jaya, Selangor Darul Ehsan
Malaysia
Phone: +603-7805-3222
Fax: +603-7804-8563
www.tungaloy.com/my

Tungaloy Australia Pty Ltd

Unit 68 1470 Ferntree Gully Road
Knoxfield 3180 Victoria, Australia
Phone: +61-3-9755-8147
Fax: +61-3-9755-6070
www.tungaloy.com/au

PT. Tungaloy Indonesia

Kompleks Grand Wisata Block AA-
10 No.3-5 Cibitung
Bekasi 17510, Indonesia
Phone: +62-21-8261-5808
Fax: +62-21-8261-5809
www.tungaloy.com/id



High-Precision Solutions for

MACHINING MINIATURE PARTS

1 + 1 > 2



Distributed by:



FIND US ON THE CLOUD!
machiningcloud.com